

Pioneer *sound.vision.soul*

DVD Player

DV-79AVi DV-79AVi-S ELITE



Register Your Product at
www.pioneerelectronics.com (US)
www.pioneerelectronics.ca (Canada)

Operating Instructions

RW
COMPATIBLE



The lightning flash with arrowhead, within an equilateral triangle, is intended to alert the user to the presence of uninsulated "dangerous voltage" within the product's enclosure that may be of sufficient magnitude to constitute a risk of electric shock to persons.

CAUTION
RISK OF ELECTRIC SHOCK
DO NOT OPEN

CAUTION:
TO PREVENT THE RISK OF ELECTRIC SHOCK, DO NOT REMOVE COVER (OR BACK). NO USER-SERVICEABLE PARTS INSIDE. REFER SERVICING TO QUALIFIED SERVICE PERSONNEL.



The exclamation point within an equilateral triangle is intended to alert the user to the presence of important operating and maintenance (servicing) instructions in the literature accompanying the appliance.

D1-4-2-3_En

IMPORTANT NOTICE – THE SERIAL NUMBER FOR THIS EQUIPMENT IS LOCATED IN THE REAR. PLEASE WRITE THIS SERIAL NUMBER ON YOUR ENCLOSED WARRANTY CARD AND KEEP IN A SECURE AREA. THIS IS FOR YOUR SECURITY.

D1-4-2-6-1_En

NOTE: This equipment has been tested and found to comply with the limits for a Class B digital device, pursuant to Part 15 of the FCC Rules. These limits are designed to provide reasonable protection against harmful interference in a residential installation. This equipment generates, uses, and can radiate radio frequency energy and, if not installed and used in accordance with the instructions, may cause harmful interference to radio communications. However, there is no guarantee that interference will not occur in a particular installation. If this equipment does cause harmful interference to radio or television reception, which can be determined by turning the equipment off and on, the user is encouraged to try to correct the interference by one or more of the following measures:

- Reorient or relocate the receiving antenna.
- Increase the separation between the equipment and receiver.
- Connect the equipment into an outlet on a circuit different from that to which the receiver is connected.
- Consult the dealer or an experienced radio/TV technician for help.

D8-10-1_En

CAUTION : USE OF CONTROLS OR ADJUSTMENTS OR PERFORMANCE OF PROCEDURES OTHER THAN THOSE SPECIFIED HEREIN MAY RESULT IN HAZARDOUS RADIATION EXPOSURE.

CAUTION : THE USE OF OPTICAL INSTRUMENTS WITH THIS PRODUCT WILL INCREASE EYE HAZARD.

D6-8-2-1_En

Information to User

Alteration or modifications carried out without appropriate authorization may invalidate the user's right to operate the equipment.

D8-10-2_En

CAUTION – TO PREVENT ELECTRIC SHOCK DO NOT USE THIS (POLARIZED) PLUG WITH AN EXTENSION CORD, RECEPTACLE OR OTHER OUTLET UNLESS THE BLADES CAN BE FULLY INSERTED TO PREVENT BLADE EXPOSURE.

ATTENTION – POUR PREVENIR LES CHOCS ELECTRIQUES NE PAS UTILISER CETTE FICHE POLARISEE AVEC UN PROLONGATEUR UNE PRISE DE COURANT OU UNE AUTRE SORTIE DE COURANT, SAUF SI LES LAMES PEUVENT ETRE INSEREES A FOND SANS EN LAISSER AUCUNE PARTIE A DECOUVERT.

D2-4-4-1_EF

WARNING – TO PREVENT FIRE OR SHOCK HAZARD, DO NOT EXPOSE THIS APPLIANCE TO RAIN OR MOISTURE.

D1-4-2-1_En

WARNING: Handling the cord on this product or cords associated with accessories sold with the product will expose you to lead, a chemical known to the State of California and other governmental entities to cause cancer and birth defects or other reproductive harm.

Wash hands after handling

D36-P4_En

This product contains mercury. Disposal of this material may be regulated due to environmental considerations. For disposal or recycling information, please contact your local authorities or the Electronics Industries Alliance : www.eiae.org.

K057_En

IMPORTANT SAFETY INSTRUCTIONS

READ INSTRUCTIONS — All the safety and operating instructions should be read before the product is operated.

RETAIN INSTRUCTIONS — The safety and operating instructions should be retained for future reference.

HEED WARNINGS — All warnings on the product and in the operating instructions should be adhered to.

FOLLOW INSTRUCTIONS — All operating and use instructions should be followed.

CLEANING — The product should be cleaned only with a polishing cloth or a soft dry cloth. Never clean with furniture wax, benzene, insecticides or other volatile liquids since they may corrode the cabinet.

ATTACHMENTS — Do not use attachments not recommended by the product manufacturer as they may cause hazards.

WATER AND MOISTURE — Do not use this product near water — for example, near a bathtub, wash bowl, kitchen sink, or laundry tub; in a wet basement; or near a swimming pool; and the like.

ACCESSORIES — Do not place this product on an unstable cart, stand, tripod, bracket, or table. The product may fall, causing serious injury to a child or adult, and serious damage to the product. Use only with a cart, stand, tripod, bracket, or table recommended by the manufacturer, or sold with the product. Any mounting of the product should follow the manufacturer's instructions, and should use a mounting accessory recommended by the manufacturer.

CART — A product and cart combination should be moved with care. Quick stops, excessive force, and uneven surfaces may cause the product and cart combination to overturn.



VENTILATION — Slots and openings in the cabinet are provided for ventilation and to ensure reliable operation of the product and to protect it from overheating, and these openings must not be blocked or covered. The openings should never be blocked by placing the product on a bed, sofa, rug, or other similar surface. This product should not be placed in a built-in installation such as a bookcase or rack unless proper ventilation is provided or the manufacturer's instructions have been adhered to.

POWER SOURCES — This product should be operated only from the type of power source indicated on the marking label. If you are not sure of the type of power supply to your home, consult your product dealer or local power company.

LOCATION — The appliance should be installed in a stable location.

NONUSE PERIODS — The power cord of the appliance should be unplugged from the outlet when left un-used for a long period of time.

GROUNDING OR POLARIZATION

- If this product is equipped with a polarized alternating current line plug (a plug having one blade wider than the other), it will fit into the outlet only one way. This is a safety feature. If you are unable to insert the plug fully into the outlet, try reversing the plug. If the plug should still fail to fit, contact your electrician to replace your obsolete outlet. Do not defeat the safety purpose of the polarized plug.
- If this product is equipped with a three-wire grounding type plug, a plug having a third (grounding) pin, it will only fit into a grounding type power outlet. This is a safety feature. If you are unable to insert the plug into the outlet, contact your electrician to replace your obsolete outlet. Do not defeat the safety purpose of the grounding type plug.

POWER-CORD PROTECTION — Power-supply cords should be routed so that they are not likely to be walked on or pinched by items placed upon or against them, paying particular attention to cords at plugs, convenience receptacles, and the point where they exit from the product.

OUTDOOR ANTENNA GROUNDING — If an outside antenna or cable system is connected to the product, be sure the antenna or cable system is grounded so as to provide some protection against voltage surges and built-up static charges. Article 810 of the National Electrical Code, ANSI/NFPA 70, provides information with regard to proper grounding of the mast and supporting structure, grounding of the lead-in wire to an antenna discharge unit, size of grounding conductors, location of antenna-discharge unit, connection to grounding electrodes, and requirements for the grounding electrode. See Figure A.

LIGHTNING — For added protection for this product during a lightning storm, or when it is left unattended and unused for long periods of time, unplug it from the wall outlet and disconnect the antenna or cable system. This will prevent damage to the product due to lightning and power-line surges.

POWER LINES — An outside antenna system should not be located in the vicinity of overhead power lines or other electric light or power circuits, or where it can fall into such power lines or circuits. When installing an outside antenna system, extreme care should be taken to keep from touching such power lines or circuits as contact with them might be fatal.

OVERLOADING — Do not overload wall outlets, extension cords, or integral convenience receptacles as this can result in a risk of fire or electric shock.

OBJECT AND LIQUID ENTRY — Never push objects of any kind into this product through openings as they may touch dangerous voltage points or short-out parts that could result in a fire or electric shock. Never spill liquid of any kind on the product.

SERVICING — Do not attempt to service this product yourself as opening or removing covers may expose you to dangerous voltage or other hazards. Refer all servicing to qualified service personnel.

DAMAGE REQUIRING SERVICE — Unplug this product from the wall outlet and refer servicing to qualified service personnel under the following conditions:

- When the power-supply cord or plug is damaged.
- If liquid has been spilled, or objects have fallen into the product.
- If the product has been exposed to rain or water.
- If the product does not operate normally by following the operating instructions. Adjust only those controls that are covered by the operating instructions as an improper adjustment of other controls may result in damage and will often require extensive work by a qualified technician to restore the product to its normal operation.
- If the product has been dropped or damaged in any way.
- When the product exhibits a distinct change in performance — this indicates a need for service.

REPLACEMENT PARTS — When replacement parts are required, be sure the service technician has used replacement parts specified by the manufacturer or have the same characteristics as the original part. Unauthorized substitutions may result in fire, electric shock, or other hazards.

SAFETY CHECK — Upon completion of any service or repairs to this product, ask the service technician to perform safety checks to determine that the product is in proper operating condition.

WALL OR CEILING MOUNTING — The product should not be mounted to a wall or ceiling.

HEAT — The product should be situated away from heat sources such as radiators, heat registers, stoves, or other products (including amplifiers) that produce heat.

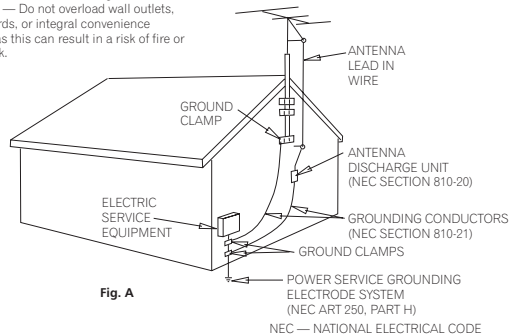

Fig. A

NEC — NATIONAL ELECTRICAL CODE

D1-4-2-2, En

This Class B digital apparatus complies with Canadian ICES-003.

Cet appareil numérique de la Classe B est conforme à la norme NMB-003 du Canada.

D8-10-1-3, EF

CAUTION: This product satisfies FCC regulations when shielded cables and connectors are used to connect the unit to other equipment. To prevent electromagnetic interference with electric appliances such as radios and televisions, use shielded cables and connectors for connections.

D8-10-3a, En

For U.S. and Australia Model



This product includes FontAvenue® fonts licenced by NEC corporation. FontAvenue is a registered trademark of NEC Corporation.

POWER-CORD CAUTION

Handle the power cord by the plug. Do not pull out the plug by tugging the cord and never touch the power cord when your hands are wet as this could cause a short circuit or electric shock. Do not place the unit, a piece of furniture, etc., on the power cord, or pinch the cord. Never make a knot in the cord or tie it with other cords. The power cords should be routed such that they are not likely to be stepped on. A damaged power cord can cause a fire or give you an electrical shock. Check the power cord once in a while. When you find it damaged, ask your nearest PIONEER authorized service center or your dealer for a replacement. **5002_En**

This product incorporates copyright protection technology that is protected by method claims of certain U.S. patents and other intellectual property rights owned by Macrovision Corporation and other rights owners. Use of this copyright protection technology must be authorized by Macrovision Corporation, and is intended for home and other limited viewing uses only unless otherwise authorized by Macrovision Corporation. Reverse engineering or disassembly is prohibited.

This product is for general household purposes. Any failure due to use for other than household purposes (such as long-term use for business purposes in a restaurant or use in a car or ship) and which requires repair will be charged for even during the warranty period. **K041_En**



We Want You Listening For A Lifetime

Dear Customer:

Selecting fine audio equipment such as the unit you've just purchased is only the start of your musical enjoyment. Now it's time to consider how you can maximize the fun and excitement your equipment offers. This manufacturer and the Electronic Industries Association's Consumer Electronics Group want you to get the most out of your equipment by playing it at a safe level. One that lets the sound come through loud and clear without annoying blaring or distortion-and, most importantly, without affecting your sensitive hearing.

Sound can be deceiving. Over time your hearing "comfort level" adapts to higher volumes of sound. So what sounds "normal" can actually be loud and harmful to your hearing. Guard against this by setting your equipment at a safe level BEFORE your hearing adapts.

To establish a safe level:

- Start your volume control at a low setting.
- Slowly increase the sound until you can hear it comfortably and clearly, and without distortion.

Once you have established a comfortable sound level:

- Set the dial and leave it there.

Taking a minute to do this now will help to prevent hearing damage or loss in the future. After all, we want you listening for a lifetime.

Used wisely, your new sound equipment will provide a lifetime of fun and enjoyment. Since hearing damage from loud noise is often undetectable until it is too late, this manufacturer and the Electronic Industries Association's Consumer Electronics Group recommend you avoid prolonged exposure to excessive noise. This list of sound levels is included for your protection.

Decibel Level Example

30	Quiet library, soft whispers
40	Living room, refrigerator, bedroom away from traffic
50	Light traffic, normal conversation, quiet office
60	Air conditioner at 20 feet, sewing machine
70	Vacuum cleaner, hair dryer, noisy restaurant
80	Average city traffic, garbage disposals, alarm clock at two feet.

THE FOLLOWING NOISES CAN BE DANGEROUS UNDER CONSTANT EXPOSURE

- 90 Subway, motorcycle, truck traffic, lawn mower
- 100 Garbage truck, chain saw, pneumatic drill
- 120 Rock band concert in front of speakers, thunderclap
- 140 Gunshot blast, jet plane
- 180 Rocket launching pad

Information courtesy of the Deafness Research Foundation.



This product complies with the following
i.LINK interface specifications:

- 1) IEEE Std 1394a-2000, Standard for a High Performance Serial Bus
- 2) Audio and Music Data Transmission Protocol 2.0

Following the standard for AM824 sequence adaptation layers, the product is compatible with IEC60958 bitstream, DVD-A and SACD media.

Contents

01 Before you start

Features	8
What's in the box	10
Putting the batteries in the remote control	10
Using the remote control	10
Disc / content format playback compatibility	11
General disc compatibility	11
CD-R/RW compatibility	11
DVD-R/RW Compatibility	11
Compressed Audio Compatibility	12
PC Created Disc Compatibility	12
Titles, chapters, groups and tracks	13
DVD-Video regions	13

02 Connecting up

Rear panel	14
Easy connections	16
Using other types of video output	17
Connecting using an S-Video output	17
Connecting using the component video output	17
Connecting for multichannel surround sound	18
Connecting using the multichannel analog outputs	18
Connecting using a digital audio output	19
Connecting using i.LINK	20
About i.LINK	21
Creating an i.LINK network	21
Connecting using HDMI	22
About HDMI	23
Controlling this player from another Pioneer component	23

03 Controls and displays

Front panel	25
About progressive scan video	26
Display	27
Remote control	28
Setting up the remote to control your TV	30

04 Getting Started

Switching on	31
Let's Get Started	32
Using the on-screen displays	32
Setting up with the Setup Navigator	33
Playing discs	37
Basic playback controls	37
DVD disc menus	38
Video CD PBC menus	39

05 Playing discs

Introduction	42
Using the Disc Navigator to browse the contents of a disc	42
Scanning discs	43
Using the Multi Dial	44
Playing in slow motion	44
Frame advance/frame reverse	45
Looping a section of a disc	45
Using repeat play	46
Using random play	46
Creating a program list	47
Editing a program list	49
Other functions available from the program menu	50
Searching a disc	50
Switching subtitles	51
Switching the DVD audio language	51
Switching DVD-RW audio channels	52
Switching DVD-Audio audio channels	52
Switching CD/MP3/Video CD audio channels	52
Switching camera angles	52
Displaying disc information	52

06 Audio Settings menu

Note about features in the Audio Settings menu	54
Audio DRC	54
Legato PRO	54
Hi-Bit	55
Virtual Surround	55
Channel Level	56
Speaker Distance	57

07 The Video Settings menu

Video Adjust.....	58
Creating your own presets.....	58

08 Initial Settings menu

Using the Initial Settings menu	61
Digital Audio Out settings	61
Digital Out.....	61
Dolby Digital Out.....	62
DTS Out.....	62
Linear PCM Out.....	62
MPEG Out.....	63
Video Output settings.....	63
TV Screen	63
Component Out.....	63
S-Video Out	64
Still Picture	64
Language settings	64
Audio Language	64
Subtitle Language	65
Auto Language	65
DVD Menu Language.....	66
Subtitle Display	66
Display settings	66
OSD Language	66
On Screen Display.....	66
Angle Indicator	66
Background.....	67
Screen Saver	67
Options	67
Parental Lock.....	67
Bonus Group	69
Auto Disc Menu.....	70
Group Playback	70
DVD Playback Mode	70
SACD Playback	71
HDMI Settings.....	71
CD Playback	73
DTS Downmix	74
Speakers	74
Audio Output Mode.....	74
Speaker Installation.....	74
Speaker Distance.....	75
Channel Level	76
i.LINK Setup.....	77
Audio Out	77
Connections Setup	77
Auto Select Play.....	78
DVD-Audio Out	78

09 Additional information

Taking care of your player and discs	79
Handling discs	79
Storing discs.....	79
Discs to avoid	79
Cleaning the pickup lens.....	80
Problems with condensation.....	80
Hints on installation	80
Moving the player	80
Power cable caution	80
Screen sizes and disc formats.....	81
Widescreen TV users.....	81
Standard TV users.....	81
Resetting the player.....	81
About the audio output settings	82
About the HDMI output settings	83
HDMI output with DVD-Audio sources.....	84
About the i.LINK output settings.....	85
Language code list	86
Country/Area code list.....	86
Selecting languages using the language code list.....	87
Glossary	87
Troubleshooting	90
General.....	90
DVD/CD/Video CD/ player.....	91
HDMI troubleshooting	94
i.LINK-related messages.....	97
Specifications	98

Chapter 1

Before you start

Features

HDMI*¹ digital interface

The HDMI (High Definition Multimedia Interface) interconnect provides high quality digital audio and video, all from a single user-friendly connector. HDMI is the first consumer electronics interface to support uncompressed standard, enhanced, or high-definition video plus standard to multi-channel surround sound audio*², all using one interface. You can easily connect to a HDMI-equipped AV receiver or audiovisual device for high quality audio and video, and communication between the video source and (DTV) players, set-top boxes, and other audiovisual devices is also supported.

i.LINK*³ digital interface

The i.LINK interface makes it possible to connect this player to an i.LINK-equipped AV receiver with a single cable and enjoy high sampling rate (up to 192kHz) PCM multichannel digital audio from DVD-Audio and SACD discs, as well as digital audio from DVD-Video, CD, Video CD and MP3 discs.

In addition to simplified connection, jitterless audio is possible with Pioneer's PQLS (Precision Quartz Lock System) technology when playing CDs, SACDs and DVD-Audio discs.

Other advantages of using i.LINK include 'smart' features such as automatic configuration and automatic function selection—start playback of a disc and the receiver automatically changes the input function to this player.*⁴

Pure Audio listening

The Pure Audio feature allows you to listen to analog audio sources with the video and digital outputs disabled, and the front panel display switched off. This is particularly useful when listening to high-quality audio formats such as DVD-Audio and Super Audio CD.

DVD-Audio and SACD compatible

Experience the super high-quality audio performance of DVD-Audio and Super Audio CD (SACD).

The on-board 24-bit/192kHz DAC means that this player is fully compatible with high sampling-rate discs, capable of delivering exceptional sound quality in terms of dynamic range, low-level resolution and high-frequency detail.

In addition, with SACD playback, you can select which part of the disc you want to hear (stereo audio, multi-channel audio and, for hybrid SACDs, standard CD audio) with the simple press of a button on the front panel.

Built-in Dolby*⁵ Digital and DTS*⁶ decoding with multichannel outputs

Logos:  

This player features multichannel analog outputs for connection to an AV amplifier to give you stunning surround sound from Dolby Digital, DTS and multichannel DVD-Audio discs.

Virtual Dolby Digital using SRS TruSurround*7

Logo: 

SRS TruSurround creates a realistic surround-sound effect from any Dolby Digital or Pro Logic encoded source using just two speakers. SRS TruSurround is a process certified by Dolby Laboratories for Virtual Dolby Digital sound. See *Virtual Surround* on page 55.

PureCinema progressive scan

When connected to a progressive scan-compatible TV or monitor using the component video outputs, you can enjoy extremely stable, flicker free images, with the same frame refresh rate as the original movie (see page 26, 58).

Super Fine Focus digital filter

This improves the quality of the video output by reducing video noise and increasing the horizontal resolution to 540 lines.

MP3 compatibility

This player is compatible with CD-R, CD-RW and CD-ROM discs that contain MP3 audio tracks. See also *Compressed Audio Compatibility* on page 12.

Graphical on-screen displays

Setting up and using your DVD player is made very easy using the graphical on-screen displays.

*1 HDMI, the HDMI logo and High-Definition Multimedia Interface are trademarks or registered trademarks of HDMI licensing LLC.

*2 It is not possible to output SACD source from the HDMI connection.

*3 "i.LINK" and the "i.LINK" logo are trademarks of Sony Corporation.

*4 These features may not be compatible with all i.LINK-equipped receivers.

*5 Manufactured under license from Dolby Laboratories. "Dolby" and the double-D symbol are trademarks of Dolby Laboratories.

*6 "DTS" and "DTS Digital Surround" are registered trademarks of Digital Theater Systems, Inc.

*7 TruSurround, SRS and  symbol are trademarks of SRS Labs, Inc. TruSurround technology is incorporated under license from SRS Labs, Inc.

What's in the box

Please confirm that the following accessories are in the box when you open it.

- Remote control
- AA/LR6 batteries x2
- Stereo audio cable (red/white plugs)
- Video cable (yellow plugs)
- 4-pin S400 i.LINK cable
- Power cable
- These operating instructions
- Warranty card

Putting the batteries in the remote control

1 Open the battery compartment cover on the back of the remote control.

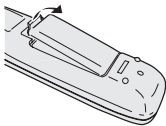

2 Insert two AA/R6P batteries into the battery compartment following the indications (+, -) inside the compartment.

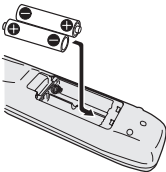

3 Close the cover.

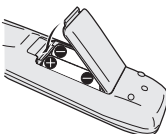

Note

Incorrect use of batteries can result in hazards such as leakage and bursting. Please observe the following:

- Don't mix new and old batteries together.
- Don't use different kinds of battery together—although they may look similar, different batteries may have different voltages.
- Make sure that the plus and minus ends of each battery match the indications in the battery compartment.
- Remove batteries from equipment that isn't going to be used for a month or more.
- When disposing of used batteries, please comply with governmental regulations or environmental public instruction's rules that apply in your country or area.

H048 En

Using the remote control

Keep in mind the following when using the remote control:

- Make sure that there are no obstacles between the remote and the remote sensor on the unit.
- The remote has a range of about 7 meters.
- Remote operation may become unreliable if strong sunlight or fluorescent light is shining on the unit's remote sensor.
- Remote controllers for different devices can interfere with each other. Avoid using remotes for other equipment located close to this unit.
- Replace the batteries when you notice a fall off in the operating range of the remote.

Disc / content format playback compatibility

General disc compatibility

This player was designed and engineered to be compatible with software bearing one or more of the following logos:



- **DVD** is a trademark of DVD Format/Logo Licensing Corporation.

Other formats, including but not limited to the following, are not playable in this player:

Photo CD, DVD-RAM, DVD-ROM, CD-ROM*1

*1 Except those that contain MP3 files formatted as specified in the *Compressed Audio Compatibility* section.

DVD-R/RW and CD-R/RW discs (Audio CDs and Video CDs) recorded using a DVD recorder, CD recorder or personal computer may not be playable on this unit. This may be caused by a number of possibilities, including but not limited to: the type of disc used; the type of recording; damage, dirt or condensation on either the disc or the player's pick-up lens. See below for notes about particular software and formats.

- About DualDisc playback
A DualDisc is a new two-sided disc, one side of which contains DVD content video, audio, etc. while the other side contains non-DVD content such as digital audio material.

The non-DVD, audio side of the disc is not compliant with the CD Audio specification and therefore may not play. The DVD side of a DualDisc plays in this product.

For more detailed information on the DualDisc specification, please refer to the disc manufacturer or disc retailer.

CD-R/RW compatibility

- This unit will play CD-R and CD-RW discs recorded in CD Audio or Video CD format, or as a CD-ROM containing MP3 audio files. However, any other content may cause the disc not to play, or create noise/distortion in the output.
- This unit cannot record CD-R or CD-RW discs.
- Unfinalized CD-R/RW discs recorded as CD Audio can be played, but the full Table of Contents (playing time, etc.) will not be displayed.

DVD-R/RW Compatibility

- This unit will play DVD-R/RW discs that were recorded using the DVD Video format or Video Recording format.
- This unit cannot record DVD-R/RW discs.
- Unfinalized DVD-R/RW discs cannot be played in this player.

Compressed Audio Compatibility

- This unit will play CD-ROM discs containing files saved in the MPEG-1 Audio Layer 3 format (MP3) with a sampling rate of 44.1 or 48kHz. Incompatible files will not play and **UNPLAYABLE** will be displayed on the unit.
- Fixed bit-rate files are recommended. Variable bit-rate (VBR) files are playable, but playing time may not be shown correctly.
- The CD-ROM used to compile your MP3 files must be ISO 9660 Level 2 compliant.
- CD physical format: Mode1, Mode2 XA Form1.
- This player only plays tracks that are named with the file extension ".mp3" or ".MP3".
- This player is compatible with multi-session discs, but only plays sessions that are closed.
- Use CD-R or CD-RW media for recording your MP3 files.
- This player can recognize a combined total of up to 250 tracks and folders. If a disc containing over 250 tracks/folders is loaded, only the first 250 tracks/folders recorded on the disc will be playable.
- Folder and track names (excluding the ".mp3" extension) are displayed.
- There are many different recording bit-rates available to encode your MP3 files. This unit was designed to be compatible with all of them. Audio encoded at 128Kbps should sound close to regular CD Audio quality. This player will play lower bit-rate MP3 tracks, but please note that the sound quality becomes noticeably worse at lower bit-rates.

PC Created Disc Compatibility

- If you record a disc using a personal computer, even if it is recorded in a "compatible format" as listed above, there will be cases in which the disc may not be playable in this machine due to the setting of the application software used to create the disc. In these particular instances, check with the software publisher for more detailed information.
- Check the DVD-R/RW or CD-R/RW software disc boxes for additional compatibility information.

Titles, chapters, groups and tracks

DVD-Video discs are generally divided into one or more titles. Titles may be further subdivided into chapters.

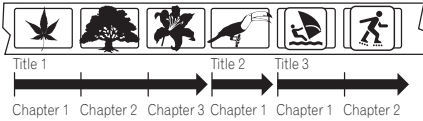

DVD-Audio discs are divided into one or more groups that can each contain a number of tracks.

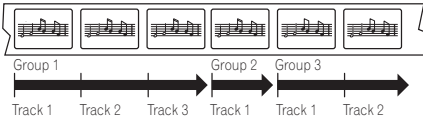

CDs, SACDs and Video CDs are divided into tracks.

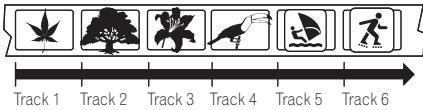

CD-ROMs containing MP3 files are divided into folders and tracks. Folders may also contain further subfolders.

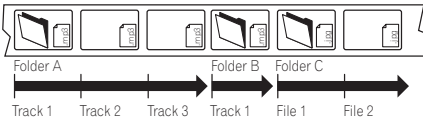

DVD-Video regions

All DVD-Video discs carry a region mark on the case somewhere that indicates which region(s) of the world the disc is compatible with. Your DVD player also has a region mark, which you can find on the rear panel. Discs from incompatible regions will not play in this player. Discs marked **ALL** will play in any player.

The diagram below shows the various DVD regions of the world.

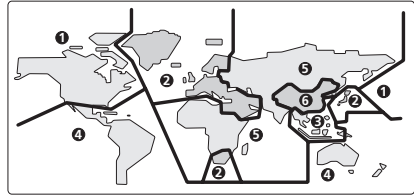

Chapter 2

Connecting up

Rear panel

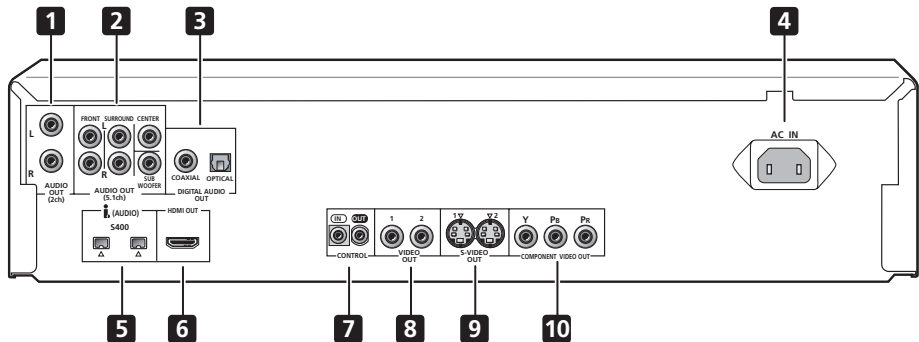

When connecting this player up to your TV, AV receiver or other components, make sure that all components are switched off and unplugged.

1 AUDIO OUT (2ch)

Two channel analog audio outputs for connection to your TV, AV receiver or stereo system (page 16,19).

2 AUDIO OUT (5.1ch)

Multichannel analog audio outputs for connection to an AV receiver with multichannel inputs (page 18).

3 DIGITAL AUDIO OUT – OPTICAL / COAXIAL

Digital audio outputs for connection to a PCM, Dolby Digital, DTS and/or MPEG-compatible AV receiver (page 19).

4 AC IN

Connect the supplied power cord here, then plug into a power outlet. Refer to the illustration below when doing so to make sure the neutral and live blades are lined up properly.

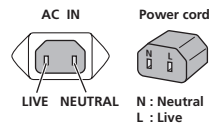

5 i (AUDIO) – i.LINK connectors

4-pin, S400 i.LINK connectors for connection to i.LINK-equipped receivers and other components. Each i.LINK connector acts simultaneously as both input and output (page 20).

6 HDMI OUT

HDMI output providing a high quality interface for digital audio and video (page 22).

7 CONTROL IN / OUT

For passing remote control signals to other Pioneer components (page 23).

8 VIDEO OUT (1&2)

Standard video output(s) that you can connect to your TV or AV receiver using the supplied audio/video cable (page 16).

9 S-VIDEO OUT (1&2)

S-Video output(s) that you can use instead of the **VIDEO OUT** jacks (page 17).

10 COMPONENT VIDEO OUT

High quality video output for connection to a TV, monitor or AV receiver that has component video inputs.

Connect using a commercially available three-way component video cable.

Be careful to match the colors of the jacks and cables for correct connection (page 17).



Tip

- You may find it useful to have the manuals supplied with your other components handy when connecting this player.
- If you come across any unfamiliar terms in this section of the manual, take a look at the *Glossary* on page 87.

Easy connections

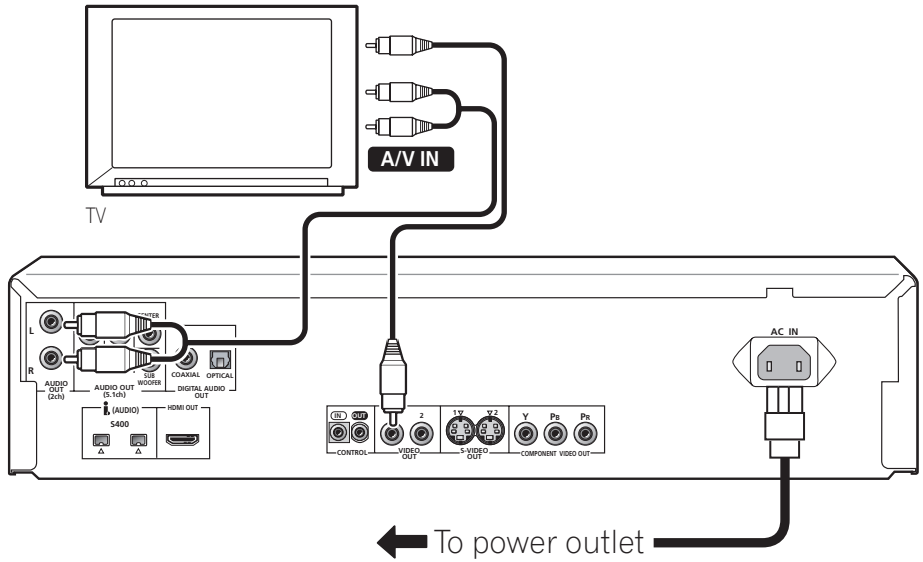

The setup described here is a basic setup that allows you to play discs using just the cables supplied with the player. In this setup, stereo audio is played through your TV.



Important

- This player is equipped with copy protection technology. Do not connect this player to your TV via a VCR using AV cables, as the picture from this player will not appear properly on your TV. (This player may also not be compatible with some combination TV/VCRs for the same reason; refer to the manufacturer for more information.)

1 Connect the VIDEO OUT and AUDIO OUT (2ch) jacks to a set of A/V inputs on your TV.

Use the supplied red/white stereo audio and yellow video cable. Make sure you match up the left and right audio outputs with their

corresponding inputs for correct stereo sound.

See *Using other types of video output* below if you want to use a different type of connection.

- If you need another pair of stereo outputs (and don't need to use the multichannel analog outputs), you can use the **AUDIO OUT (5.1ch) FRONT L / R** jacks (page 18).

2 Connect the supplied AC power cord to the AC IN inlet, then plug into a power outlet.



Important

- Do not unplug the player from the power outlet while it is switched on.
- Do not plug this player into a switched power supply found on some amplifiers and AV receivers.

Using other types of video output

This player has standard (composite), S-video and component video outputs, as well as an HDMI connector (for digital video/audio). The main difference between them is the quality of the picture.

S-video delivers a better picture than standard composite video, while component video gives better picture quality still. The variety of outputs also gives you the flexibility of connecting your particular equipment using the best connection type available.

HDMI provides highest quality digital video (and audio) using one simple digital connection, provided your monitor or display is also equipped with HDMI. See *Connecting using HDMI* on page 22 for more on this.

Connecting using an S-Video output

You can use the S-Video output instead of the **VIDEO OUT** jack to connect this player to your TV (or other equipment).

- **Use an S-Video cable (not supplied) to connect the S-VIDEO OUT to an S-Video input on your TV, monitor or AV receiver.**

Line up the small triangle above the jack with the same mark on the plug before plugging in.

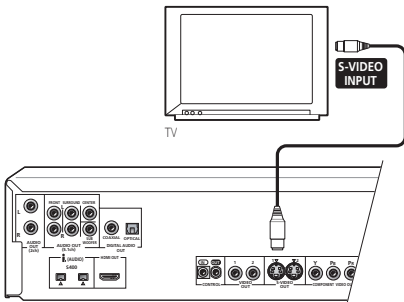

- If you connect both S-video jacks, but one of the connected components is not S1/S2 compatible, the automatic aspect ratio switching will not work with either connected component.

Connecting using the component video output

You can use the component video output instead of the standard video out jack to connect this player to your TV (or other equipment).

- **Use a component video cable (not supplied) to connect the COMPONENT VIDEO OUT jacks to a component video input on your TV, monitor or AV receiver.**

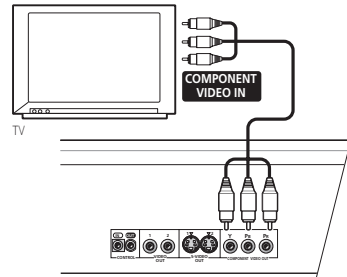

Connecting for multichannel surround sound

To enjoy multichannel surround sound from DVD-Video, DVD-Audio and SACD discs, we recommend connecting this player to an AV receiver using the 5.1 channel analog outputs or the i.LINK connector.

The player also has optical and coaxial digital outputs should you want to use an external decoder or the decoder in your AV receiver. Note that multichannel DVD-Audio and SACD audio is not output through these jacks, so this connection should be in addition to, rather than instead of, a 5.1 channel analog connection.

You'll probably also want to connect a video output to your AV receiver. You can use any of the video outputs available on this player (the following illustrations show a standard (composite) connection).

Connecting using the multichannel analog outputs

If your AV receiver has 5.1 channel analog inputs, we recommend connecting this player to it using the multichannel analog outputs. Doing this will ensure that you can enjoy all kinds of disc, including Dolby Digital and DTS DVD-Video discs, as well as high sampling rate and multichannel DVD-Audio and SACD discs.



Important

- In order to be able to hear multichannel sound from SACDs, DVD-Video and DVD-Audio discs, you need to set **SACD Playback to Multi-ch Area**, and the **Audio Output Mode to 5.1 Channel** (*SACD Playback* on page 71 and *Audio Output Mode* on page 74).

- 1 Connect the **AUDIO OUT (5.1ch) outputs on this player to the multichannel audio inputs on your AV receiver.** It's convenient to use three stereo audio cables; one for the **FRONT**, one for the **SURROUND** and one for the **CENTER** and **SUBWOOFER** channels.

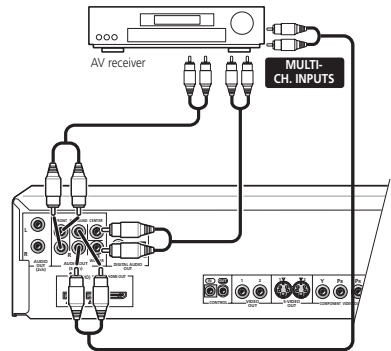

- 2 Connect the **VIDEO OUT** jack on this player to a video input on your AV receiver.

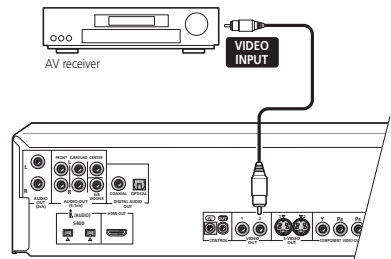

- Alternatively, you can use the S-Video or component video connections if they're available.

- 3 Connect the **AV receiver's video output to a video input on your TV.**

Tip

- You usually have to connect the same kind of video cable between your DVD player and AV receiver, and between your AV receiver and TV.

Connecting using a digital audio output

Connect the optical or coaxial digital outputs if you want to use an external decoder or the decoder in your AV receiver.

To be able to play SACDs and multichannel DVD-Audio discs, you should also connect the 5.1 channel analog outputs (*Connecting using the multichannel analog outputs above*).

If your AV receiver doesn't have 5.1 channel analog inputs, make a stereo analog connection.

1 Connect one of the DIGITAL OUT jacks on this player to a digital input on your AV receiver.

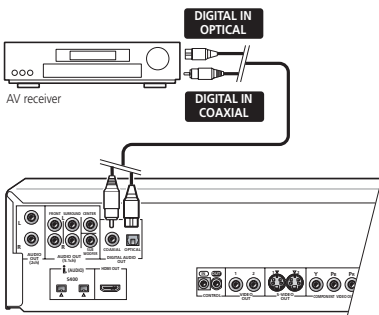

Optical connection: Use an optical cable (not supplied) to connect the **OPTICAL DIGITAL AUDIO OUT** jack to an optical input on your AV receiver.

- When inserting the plug, the protective shutter will open and you should hear the

plug click into position when fully inserted. Take care not to force the plug as this may damage the shutter, the cable and/or the player.

Coaxial connection: Use a coaxial cable (similar to the supplied video cable) to connect the **COAXIAL DIGITAL AUDIO OUT** jack to a coaxial input on your AV receiver.

2 If you didn't connect the 5.1 channel analog outputs, connect the AUDIO OUT (2ch) jacks on this player to a stereo analog input on your receiver.

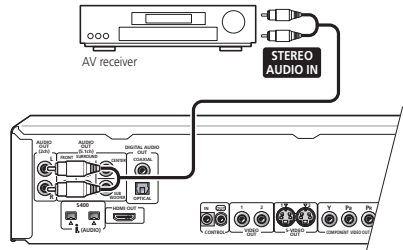

- You can also use the **AUDIO OUT 5.1ch FRONT L/R** jacks for the analog audio connection.

3 Connect the VIDEO OUT jack on this player to a video input on your AV receiver.

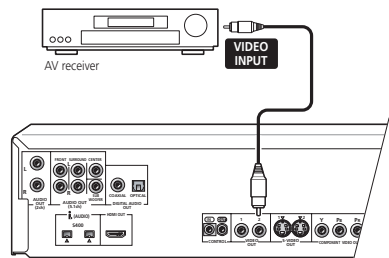

- Alternatively, you can use the S-Video or component video connections if they're available.

4 Connect the AV receiver's video output to a video input on your TV.



Tip

- You usually have to connect the same kind of video cable between your DVD player and AV receiver, and between your AV receiver and TV.

Connecting using i.LINK

If you have a receiver with an i.LINK connector, you can connect it to this player using the supplied i.LINK cable.

The i.LINK connector outputs every kind of digital audio that the player is compatible with, including DVD-Video, DVD-Audio, SACD, Video CD, CD and MP3. In contrast, the optical and coaxial digital outputs do not output SACD and multichannel DVD-Audio.

When playing DVD-Audio^{*1}, CD or SACD discs over i.LINK, the digital audio is jitterless if the connected receiver is compatible with PQLS (rate control). See the operating instructions that came with your receiver for information on compatibility with this feature.

*1 Excluding any part of the disc that features moving video (Video part).



Important

- There may be cases where the PQLS/rate control function and/or the i.LINK audio does not work properly even when connected to i.LINK Audio-compatible equipment.
- Do not disconnect i.LINK cables or switch off any components connected using i.LINK while this player is on.

- Copy-protected 96kHz DVD-Video discs are downsampled to 48kHz when using the i.LINK connection.

1 Use the supplied i.LINK cable to connect one of the i.LINK connectors on this player to an i.LINK connector on your AV receiver.

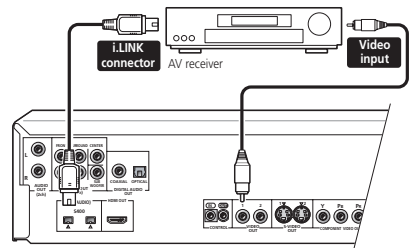

- The arrow on the cable connector body should be face down for correct alignment with the connector on the player.

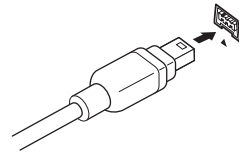

2 Connect the VIDEO OUT jack on this player to a video input on your AV receiver.

- The i.LINK connectors on this player do not output video.
- The diagram shows a standard video connection, but you can alternatively use the S-video or component video connections if they're available.



Important

- In order to be able to hear multichannel sound from SACDs, you need to set **SACD Playback to Multi-ch Area** (see *SACD Playback* on page 71).

- In order to hear multichannel sound from DVD-Audio discs, make sure that **DVD-Audio Out** is set to **5.1 Channel** (see *DVD-Audio Out* on page 78).
- To be able to use the Auto Select Play feature, you must first set it up using the **Auto Select Play** menu screen. See *Auto Select Play* on page 78.
- When the i.LINK indicator () is lit on the front panel (see *Front panel* on page 25), no audio is output from the other digital or analog audio jacks. You can switch off the i.LINK output using the **Audio Out** menu (see *Audio Out* on page 77) if you need to use the analog and/or optical/coaxial digital outputs.
- The front panel i.LINK indicator only lights when the receiver is on and the input is set to i.LINK. See also the receiver's operating instructions.

 **Note**

- You can connect several components together using i.LINK. See *Creating an i.LINK network* below.
- If you need to use an i.LINK cable other than the one supplied, please use 4-pin, S400 cables less than 3.5 meters long. Although longer ones are available, they may not work reliably.

About i.LINK

i.LINK is a trademark name for IEEE1394, a high-speed interface for digital audio, video and other data found on personal computers, digital camcorders, and other kinds of audio and audio/visual equipment. A single i.LINK connector can both send and receive data at the same time, so only one cable is required to connect components for two-way communication.

"i.LINK" and the "i.LINK" logo are trademarks of Sony Corporation.

Creating an i.LINK network

Using i.LINK it is possible to chain up to 17 components together so that the digital audio and control signals from each component is available to other components in the network. With the addition of an i.LINK repeater, it's possible to connect up to 63 components. i.LINK connectors come in 4-pin and 6-pin configurations. This player uses the 4-pin connection, but the two types can be mixed on a network.

This player is compatible with i.LINK Audio components, such as AV receivers. It may not work properly if connected to i.LINK MPEG-II TS equipment (such as a digital satellite tuner), i.LINK DV equipment (such as a DVD recorder or DV camcorder), or an i.LINK-equipped personal computer. Check the operating instructions supplied with your other i.LINK components for compatibility information.

Connected components should be DTCP (Digital Transmission Content Protection) compliant to be able to play DVD-Video, DVD-Audio and SACD i.LINK audio. If a connected component is not DTCP compliant, only CD, MP3, VCD audio will be output.

When setting up an i.LINK network, it's important that the components form an open ended chain (fig. 1), or a tree (fig. 2).

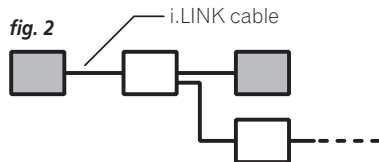
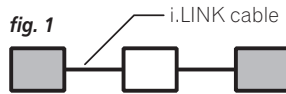

The system will not work if the connected components form a loop. If a loop is detected, the message LOOP CONNECT shows in the display. Figs. 3 and 4 show connections that form a loop.

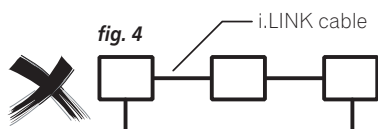
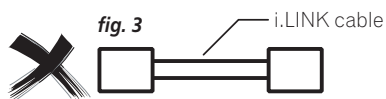

Another consideration when connecting i.LINK devices is the speed of the interface. At present there are three speeds; S100 (slowest), S200 and S400 (fastest). This player uses the S400 type. Although you can use components with different speeds together, we recommend connecting slower speed components at the edge of the network if possible (shown by the shaded boxes in figs. 1 and 2). This will keep the network free of bottlenecks.

When used within an i.LINK network, this player must be on for the i.LINK connection to be maintained. Other components in the network may or may not maintain the connection in standby (none will when the power is completely off)—check the operating instructions supplied with individual components. Note that the audio may be momentarily interrupted if a component in the i.LINK network is switched on/off, or its i.LINK connection is switched on/off.

Connecting using HDMI

If you have a HDMI or DVI (with HDCP) equipped monitor or display, you can connect it to this player using a commercially available HDMI cable.

The HDMI connector outputs uncompressed digital video, as well as almost every kind of digital audio that the player is compatible with, including DVD-Video, DVD-Audio (see below for limitations), Video CD, CD and MP3.

1 Use an HDMI cable to connect the HDMI OUT interconnect on this player to an HDMI interconnect on a HDMI-compatible monitor.

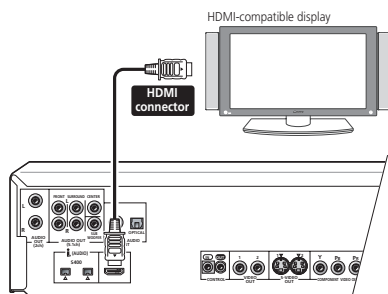

- The arrow on the cable connector body should be face up for correct alignment with the connector on the player.

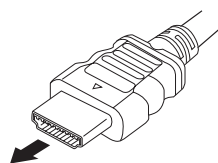

When you first switch on the player, you will see the HDMI settings menu appear on your monitor or display. From here you can select the resolution, aspect ratio, color and audio settings, as well as adjust the video presentation to your liking. For more on these settings see *HDMI Settings* on page 71.

HDMI or **DVI** appears in the front panel display according to the compatibility of the component connected.

**Note**

- An HDMI connection can only be made with DVI-equipped components compatible with both DVI and High Bandwidth Digital Content Protection (HDCP). If you choose to connect to a DVI connector, you will need a separate adaptor (DVI → HDMI) to do so. A DVI connection, however, does not support audio signals. Consult your local audio dealer for more information.
- This unit has been designed to be compliant with HDMI (High Definition Multimedia Interface) Version 1.1. Depending on the component you have connected, using a DVI connection may result in unreliable signal transfers.
- When you change the component connected to the HDMI output, you will also need to change the HDMI settings to match the new component (see *HDMI Settings* on page 71 to do this). However, the settings for each component are then stored in memory (for up to 5 components).
- The HDMI connection is compatible with 2 channel linear PCM signals (44.1 to 192kHz, 16/20/24 bit), and Dolby Digital, DTS and MPEG audio bitstream (5.1 channel signals up to 96kHz, 16/20/24bit).
- It is not possible to output SACD source from the HDMI connection.

About HDMI

HDMI (High Definition Multimedia Interface) supports both video and audio on a single digital connection for use with DVD players, DTV, set-top boxes, and other AV devices. HDMI was developed to provide the technologies of High Bandwidth Digital Content Protection (HDCP) as well as Digital Visual Interface (DVI) in one specification. HDCP is used to protect digital content transmitted and received by DVI-compliant displays.

HDMI has the capability to support standard, enhanced, or high-definition video plus standard to multi-channel surround-sound audio. HDMI features include uncompressed digital video, a bandwidth of up to 2.2 gigabytes per second (with HDTV signals), one connector (instead of several cables and connectors), and communication between the AV source and AV devices such as DTVs.

HDMI, the HDMI logo and High-Definition Multimedia Interface are trademarks or registered trademarks of HDMI licensing LLC.

Controlling this player from another Pioneer component

This player has SR jacks which allow you to use the remote sensor on one Pioneer component to control another.

Use a mini-jack plug to connect the **CONTROL OUT** of one component to the **CONTROL IN** of another. In this way you can daisy-chain several components together.

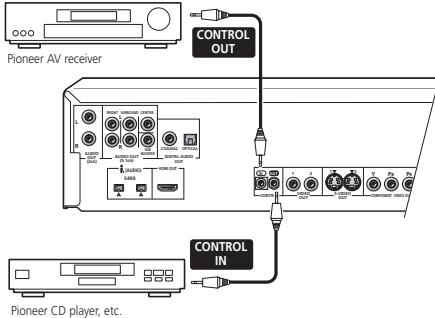

- *I connected the DVD player to my AV receiver, and although the sound is fine, there's no picture. What did I do wrong?*
Make sure that the type of video connection from the DVD player to your AV receiver is the same as that from the receiver to your TV. Most AV receivers won't convert from one kind of connection to another.



FAQ

- *My TV doesn't have any inputs to connect the DVD player. How can I watch DVDs?*

Unfortunately, if your TV has no inputs you can't use this player with it.

- *My VCR is already connected to my TV, so there aren't any spare inputs. What should I do?*

If all your TV's inputs are already in use, you can buy a video input selector from an electronics store, which effectively gives you more inputs.

- *My TV only has one input for the sound. What should I plug it into?*

If you don't mind mono sound, you can buy a stereo RCA-to-mono RCA cable from an electronics store. Connect the stereo end to this player and the mono end to your TV.

If you want stereo sound, connect this player to your amplifier or stereo system using a stereo audio cable.

Chapter 3 Controls and displays

Front panel

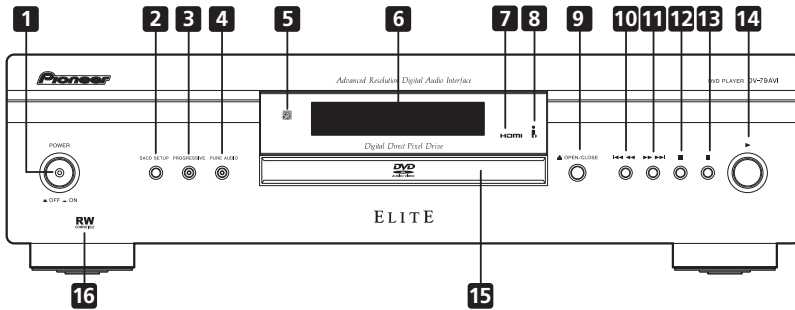

1 POWER switch

Press to switch the player on (the power indicator lights blue when the power is on) or off.

2 SACD SETUP button

Press to select which part of an SACD disc you want to listen to — stereo audio (**2ch Area**), multi-channel audio (**Multi-ch Area**) and, for hybrid SACDs, standard CD audio (**CD Area**).

- See *SACD Playback* on page 71 for more on this.

3 PROGRESSIVE button/indicator

Press to switch the component video output mode between progressive and interlace. The indicator lights in progressive scan mode. See also *Component Out* on page 63.

4 PURE AUDIO button/indicator

When the player is stopped, press to switch off/on the front panel display and disable the video and digital outputs*. Use this when you want to hear audio from the analog outputs

with no interference from other signals (when listening to a DVD-Audio disc, for example). The indicator lights when the Pure Audio feature is switched on.

- * These include i.LINK, HDMI, and the coaxial and optical digital outputs.

5 Remote control sensor

The remote control has a range of up to about 7m.

6 Display

See page 27 for a description of the display.

7 HDMI indicator

Lights when this player is recognized by another HDMI or DVI/HDCP compatible component.

8 i.LINK indicator

Lights when this player is recognized by another i.LINK compatible component.

9 ▲ OPEN/CLOSE

Press to open or close the disc tray (when in standby, this button will also switch the power on).

10  **(reverse scan/skip)**

- Press and hold for fast reverse scanning
- Press to jump back to the beginning of the current chapter or track, then to previous chapters/tracks

11  **(forward scan/skip)**

- Press and hold for fast forward scanning
- Press to jump to the next chapter or track

12  **(stop)**

Press to stop the disc (you can resume playback by pressing  (play)).

13  **(pause)**

Press to pause playback. Press again to restart.

14  **(play)**

Press to start or resume playback (when in standby, this button will also switch the power on).

15 **Disc tray****16**  **COMPATIBLE**

This mark indicates compatibility with DVD-RW discs recorded on a DVD recorder in Video Recording mode.

About progressive scan video

Compared to interlace video, progressive scan video effectively doubles the scanning rate of the picture, resulting in a very stable, flicker-free image.

Progressive scan video is available only from the component video output. Use the **PROGRESSIVE** button on the front panel to switch the component video output between interlace and progressive. With a DVD-Video disc you can do this during playback, or when the disc is stopped. For other types of disc, the player must be stopped.

**Important**

- If you connect a TV that is not compatible with a NTSC or PAL progressive scan signal and switch the player to progressive, you will not be able to see any picture at all. In this case, press the **PROGRESSIVE** button on the front panel to switch back to interlace (the **PROGRESSIVE** indicator should be unlit).

**Note**

- You can't switch video output when an OSD is on-screen.
- The picture on some TVs may momentarily break up when you switch the video output of this player.

Display

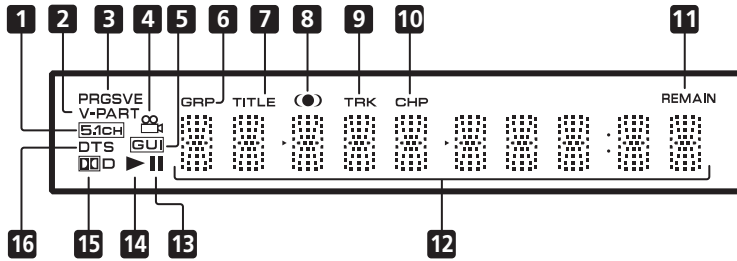

1 5.1CH

Lights when analog 5.1 channel output is selected (see *Audio Output Mode* on page 74).

2 V-PART

Lights when playing a video part of a DVD disc.

3 PRGSVE

Lights when the video output is progressive scan (see *About progressive scan video* on page 26).

4 

Lights during multi-angle scenes on a DVD disc (see *Switching camera angles* on page 52).

5 GUI (Graphical User Interface)

Lights when a menu is displayed on-screen.

6 GRP

Indicates that the character display is showing a DVD-Audio group number

7 TITLE

Indicates that the character display is showing a DVD-Video title number.

8 

Lights when **Dolby Digital/TruSurround** is active (see *Virtual Surround* on page 55).

9 TRK

Indicates that the character display is showing a track number.

10 CHP

Indicates that the character display is showing a DVD chapter number.

11 REMAIN

Lights when the character display is showing the time or number of tracks/titles/chapters remaining.

12 Character display

13 

Lights when a disc is paused.

14 

Lights when a disc is playing.

15 

Lights when a Dolby Digital soundtrack is playing.

16 DTS

Lights when a DTS soundtrack is playing.

Remote control



Tip

- All buttons glow slightly in the dark for ease of use.

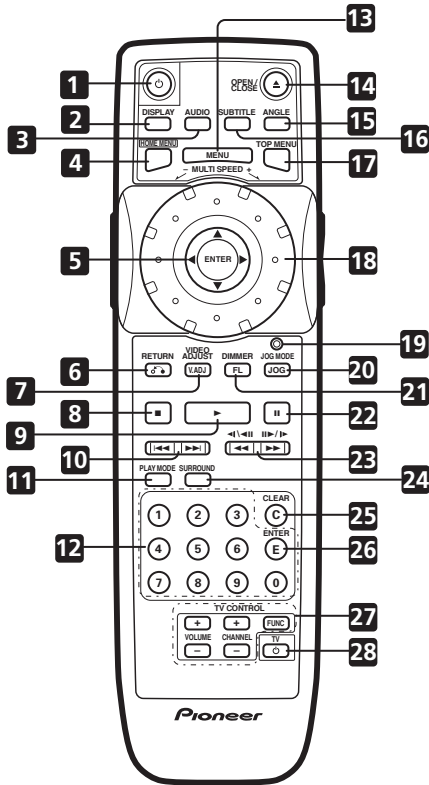

1 STANDBY/ON

Press to switch the player on or into standby.

2 DISPLAY

Press to display information about the disc playing (see *Displaying disc information* on page 52).

3 AUDIO

Press to select the audio channel or language (see page 51–page 52).

4 HOME MENU

Press to display (or exit) the on-screen display.

5 ENTER & Joystick

Use to navigate on-screen displays and menus. Press **ENTER** to select an option or execute a command.

6 (RETURN)

Press to return to a previous menu screen.

7 V.ADJ (VIDEO ADJUST)

Press to display the Video Adjust menu (see *Video Adjust* on page 58).

8 ■

Press to stop the disc (you can resume playback by pressing **▶** (play)).

9 ▶

Press to start or resume playback.

10

Press to jump to the start of the previous / next chapter / track.

11 PLAY MODE

Press to display the Play Mode menu (see page 45–page 50) (You can also get to the Play Mode menu by pressing **HOME MENU** and selecting **Play Mode**).

12 Number buttons

13 MENU

Press to display a DVD disc menu, or the Disc Navigator if a DVD-RW, CD, Video CD or MP3 disc is loaded.

14 OPEN/CLOSE

Press to open or close the disc tray.

15 ANGLE

Press to change the camera angle during DVD multi-angle scene playback (see *Switching camera angles* on page 52).

16 SUBTITLE

Press to select a subtitle display (see *Switching subtitles* on page 51).

17 TOP MENU

Press to display the top menu of a DVD disc.

18 MULTI dial

Use for scanning and slow motion control (see *Using the Multi Dial* on page 44).

19 Jog indicator

Lights when multi dial is in jog mode (see *Using the Multi Dial* on page 44).

20 JOG (JOG MODE)

Press to put switch jog mode on/off. When on, use the **MULTI** dial to advance or reverse frames (see *Using the Multi Dial* on page 44).

21 FL (DIMMER)

Press to change the display brightness.

22 II

Press to pause playback; press again to restart.

23 ◀◀ and ◀|/◀|| / ▶▶ and ||▶/|▶

Use for reverse / forward slow motion playback, frame reverse / advance and reverse / forward scanning (see page 43–page 45).

24 SURROUND

Press to activate/switch off **DOLBY** **TruSurround**.

25 CLEAR

Press to clear a numeric entry.

26 ENTER

Press to select an option or execute a command.

27 TV CONTROL buttons

VOLUME

Use to adjust the volume.

CHANNEL

Use to select TV channel.

FUNC

Press **FUNC** to select the TV for remote control operation.

28 TV

Press  **TV** to turn the TV on or into standby.

Setting up the remote to control your TV

1 Input the manufacturer code.

While holding down the **CLEAR** button, input the two digit code from the table below that corresponds to the make of your TV.

For example, If you have a Pioneer TV, press and hold **CLEAR**, then press **0, 0** on the remote control.

2 Confirm that the TV is responding to the programmed code.

On the remote, press the **TV** button. If the TV switches on (or into standby if it was on previously), then you have the correct code.

If nothing happens when you press the **TV** button, start again from step 1 using a different code.

- Some manufacturers have several codes. Try each one until you find the one that works.

Preset code list

Manufacturer	Preset Code
Pioneer	00, 34
RCA	01, 15, 16, 17, 18
Sharp	02, 19, 27
Zenith	03, 20
Sony	04
Toshiba	05, 26, 30
Hitachi	06, 24, 25, 31
Philips	07
Panasonic	08, 22
Mitsubishi	09
Goldstar	10, 23
GE	11, 28
Magnavox	12, 29
JVC	13, 32
Sanyo	14, 21
Fujitsu	33
Gradiente	35

Chapter 4

Getting Started

Switching on

After making sure that everything is connected properly and that the player is plugged in, press **POWER** to switch the player on.

Also, switch on your TV and make sure that it is set to the input you connected the DVD player to.

- You can also use the the **⏻ STANDBY/ON** button on the remote control to switch the power on.

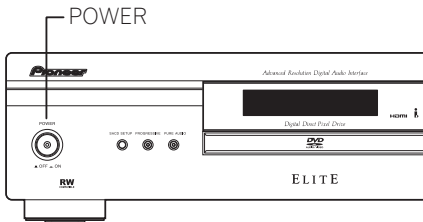

Tip

- When the player is in standby, you can use the **▲ OPEN/CLOSE** and **▶ (play)** buttons to switch the player on and open the disc tray/start playing a loaded disc.

FAQ

- My DVD player switches on but there is nothing displayed on my TV.*

Make sure that the TV is set to the correct video input (not a TV channel). For example, if you connected this player to the **VIDEO 1** inputs on your TV, switch your TV to **VIDEO 1**.

- If you connected this player to an AV receiver, make sure that the receiver is switched on and set to the correct input.

Note

- This player features a screen saver. When on, if the player is stopped or paused and no button is pressed for five minutes, the screen saver starts. See *Screen Saver* on page 67 for how to switch it on.

Let's Get Started

When you switch on the player for the first time, you should see a welcome screen displayed on your TV. From here you can let the player know what kind of TV you have, then either use the Setup Navigator to make more settings, or jump right in and start playing some discs.

Before continuing, make sure that you've loaded the batteries in the remote control.



Note

- If you have connected an HDMI-compatible device, the HDMI settings screen will appear instead of the setup screens below. See *HDMI Settings* on page 71 to make the necessary settings.

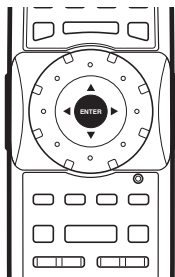

- 1 Press **ENTER** to move on to the next screen.

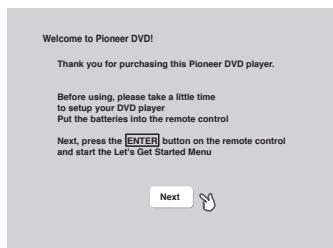

- 2 Use the Joystick (left/right) to select either 'Wide screen (16:9)' or 'Standard size screen (4:3)' according to the kind of TV you have, then press **ENTER**.

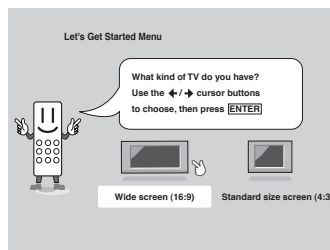

- 3 Press **ENTER** again to finish setting up.

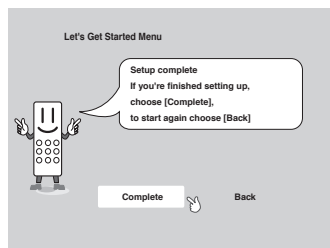

- Select **Back** then press **ENTER** if you want to go back and change the setting you just made.

Using the on-screen displays

For ease of use, this player makes extensive use of graphical on-screen displays (OSDs). You should get used to the way these work as you'll need to use them when setting up the player, using some of the playback features, such as program play, and when making more advanced settings for audio and video.

All the screens are navigated in basically the same way, using the joystick to change the highlighted item and pressing **ENTER** to select it.



Important

- Throughout this manual, 'Select' means use the joystick to highlight an item on-screen, then press **ENTER**.

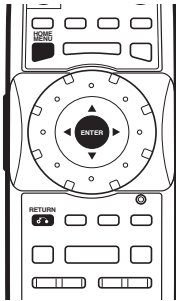

Button	What it does
HOME MENU	Display/exit the on-screen display
↑ ↓ ← → (Joystick)	Changes the highlighted menu item
ENTER	Selects the highlighted menu item
↶ (RETURN)	Returns to the previous menu without saving changes



Tip

- Information at the bottom of every OSD screen explains the currently selected menu item and shows which buttons can be used for that screen.

Setting up with the Setup Navigator

Using the Setup Navigator you can make a number of other initial settings for this player. We recommend using the Setup Navigator, especially if you connected this player to an AV receiver for playing surround sound. To answer some of the questions about digital audio formats you may need to look at the instructions that came with your AV receiver.

1 If a disc is playing, press ■ (stop).

Also turn on your TV and make sure that it is set to the correct video input.

2 Press HOME MENU.

The on-screen display (OSD) appears.

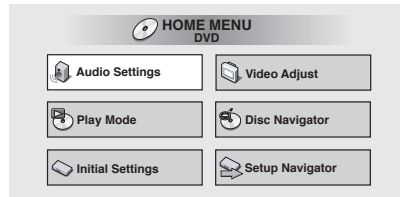

3 Select 'Setup Navigator'.

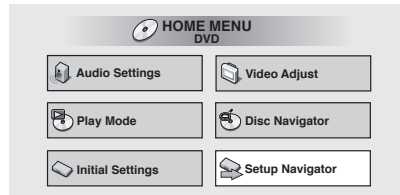

4 Select a DVD language.

Some DVD discs feature on-screen menus, soundtracks and subtitles in several languages. Set your preferred language here.

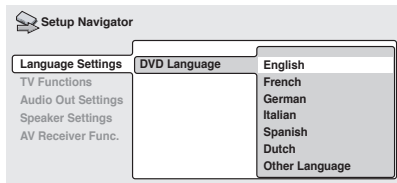

- Note that the language you choose here may not be available on all discs.
- If you want to select a language other than those listed, select **Other Language**. See *Selecting languages using the language code list* on page 87 for detailed information.

5 Is your TV/monitor compatible with progressive-scan video?

Select **Compatible**, **Not Compatible** or **Don't Know**.

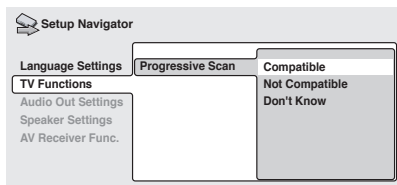

- This setting is only applicable if you used the component video outputs to connect up your TV/monitor.

6 Did you connect this player to an AV receiver?

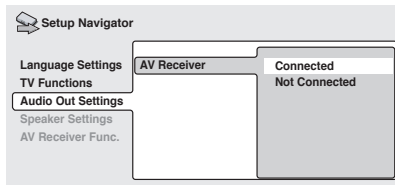

- If you selected **Not Connected** here, that completes the setup. Press **ENTER** to leave the Setup Navigator.

7 Did you connect the 5.1 channel analog audio outputs to your AV receiver?

Select **Connected** or **Not Connected**.

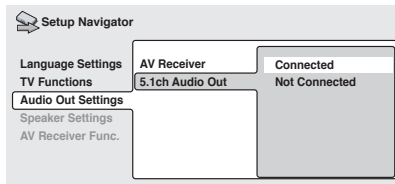

8 Did you connect a digital output to your AV receiver?

Select **Connected** or **Not Connected**.

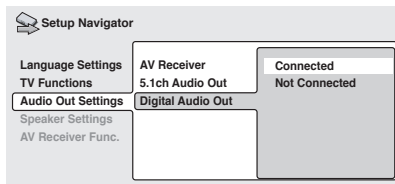

- If you selected **Not Connected** in both steps 7 and 8, that completes the setup. Press **ENTER** to leave the Setup Navigator.

*If you selected **Connected** in step 7, then answer the following questions about the speakers in your system, otherwise jump to step 12.*

9 Do you have a center speaker connected to your AV receiver?

Select **Connected** or **Not Connected**.

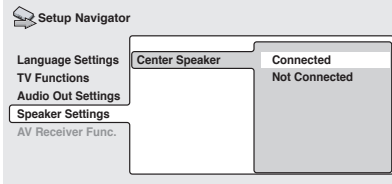

10 Do you have surround speakers connected to your AV receiver?

Select **Connected** or **Not Connected**.

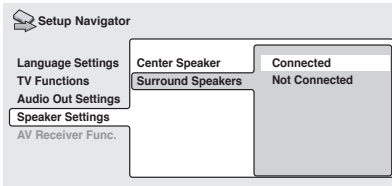

11 Do you have a sub-woofer connected to your AV receiver?

Select **Connected** or **Not Connected**.

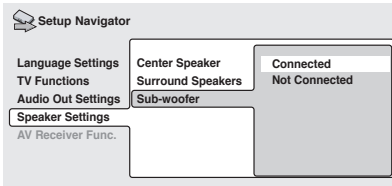

- If you selected **Not Connected** in step 8, that completes the setup. Press **ENTER** to leave the Setup Navigator.

Questions 12 through 15 are concerned with the digital decoding capabilities of your AV receiver.

12 Is your AV receiver Dolby Digital compatible?

Select **Compatible**, **Not Compatible** or **Don't Know**.

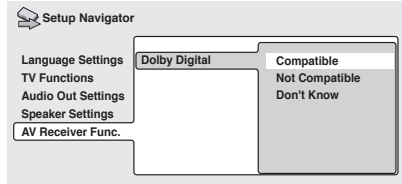

13 Is your AV receiver DTS compatible?

Select **Compatible**, **Not Compatible** or **Don't Know**.

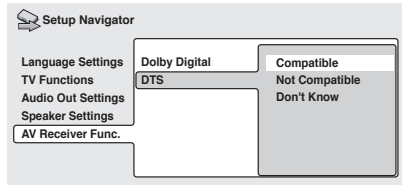

14 Is your AV receiver compatible with 96kHz Linear PCM audio?

Select **Compatible**, **Not Compatible** or **Don't Know**.

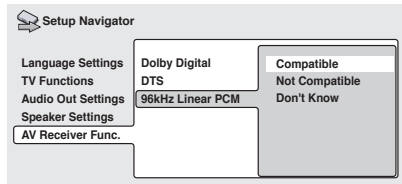

15 Is your AV receiver MPEG compatible?

Select **Compatible**, **Not Compatible** or **Don't Know**.

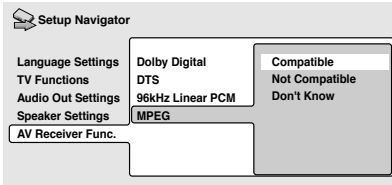

16 Press **ENTER** to complete the setup, or press **HOME MENU** to quit the Setup Navigator without making any changes.

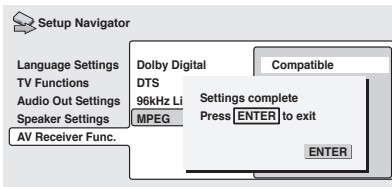

Congratulations, setup is complete!

Playing discs

The basic playback controls for playing DVD, CD, SACD, Video CD and MP3 discs are covered here. Further functions are detailed in the next chapter.



Important

- Throughout this manual, the term 'DVD' means DVD-Video, DVD-Audio and DVD-R/RW. If a function is specific to a particular kind of DVD disc, it is specified.

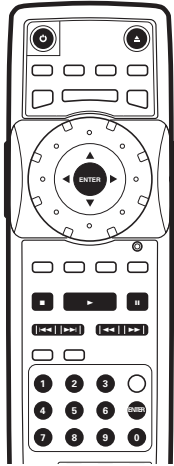

1 If the player isn't already on, press **⏻** STANDBY/ON to switch it on.

If you're playing a DVD or Video CD, also turn on your TV and make sure that it is set to the correct video input.

2 Press **⏏** OPEN/CLOSE to open the disc tray.

3 Load a disc.

Load a disc with the label side facing up, using the disc tray guide to align the disc.

Never load more than one disc at a time.

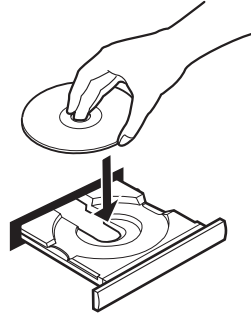

4 Press **▶** (play) to start playback.

If you're playing a DVD or Video CD, a menu may appear. See *DVD disc menus* on page 38 and *Video CD PBC menus* on page 39 for how to navigate these.

If you're playing an MP3 disc, it may take a few seconds before playback starts, depending on the complexity of the file structure on the disc.

Basic playback controls

The table below shows the basic controls on the remote for playing discs. The following chapter covers more playback features in more detail.

Button	What it does
▶	Starts playback. DVD and Video CD: if the display shows RESUME , playback starts from the resume point.
⏏	Pauses a disc that's playing, or restarts a paused disc.

Button	What it does
■	Stops playback. DVD-Video and DVD-RW and Video CD: Press ■ (stop) again to cancel the resume function. (The resume function is also cancelled when you eject the disc tray.)
◀◀	Press to start fast reverse scanning. Press ▶ (play) to resume normal playback.
▶▶	Press to start fast forward scanning. Press ▶ (play) to resume normal playback.
◀◀◀	Skips to the start of the current track or chapter, then to previous tracks/chapters.
▶▶▶	Skips to the next track or chapter.
Numbers	Use to enter a title/group/track number. Press ENTER to select (or wait a few seconds). <ul style="list-style-type: none"> • If the disc is stopped, playback starts from the selected title/group (for DVD) or track number (for CD/SACD/Video CD/MP3). • If the disc is playing, playback jumps to the start of the selected chapter or track (within the current group for DVD-Audio).

Front panel controls

The ▶ (play), ■ (stop), and || (pause) buttons on the front panel work in exactly the same way as their remote control equivalents. The combined scan/skip buttons on the front panel (◀◀◀◀ and ▶▶▶▶) work slightly differently from the remote buttons.

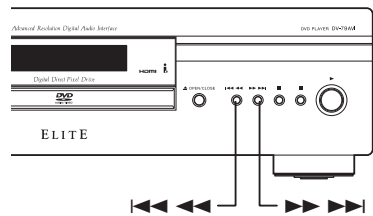

Press and hold for fast scan; press for track/chapter skip.



Important

- You may find with some DVD discs that some playback controls don't work in certain parts of the disc. This is not a malfunction.

DVD disc menus

Many DVD-Video and DVD-Audio discs contain menus from which you can select what you want to watch or listen to. They may give access to additional features, such as subtitle and audio language selection, or special features such as slideshows. See the disc packaging for details.

Sometimes menus are displayed automatically when you start playback; others only appear when you press **MENU** or **TOP MENU**.



Important

- Some DVD-Audio discs feature a 'bonus group'. To access this group you have to input a password, which you can find on the disc's packaging. See *Bonus Group* on page 69 for more information.

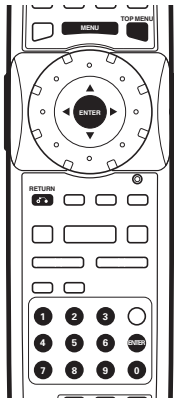

Video CD PBC menus

Some Video CDs have menus from which you can choose what you want to watch. These are called PBC (Playback control) menus.

You can play a PBC Video CD without having to navigate the PBC menu by starting playback using a number button or track skip button (▶▶) to select a track, rather than the ▶ (play) button.

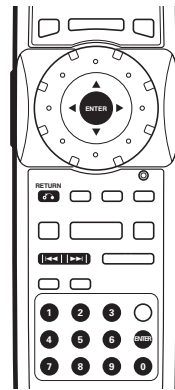

Button	What it does
TOP MENU	Displays the 'top menu' of a DVD disc—this varies with the disc.
MENU	Displays a DVD disc menu—this varies with the disc and may be the same as the 'top menu'.
↑ ↓ ← → (Joystick)	Moves the cursor around the screen.
ENTER	Selects the current menu option.
↶ (RETURN)	Returns to the previously displayed menu screen. On some DVD-Audio discs featuring browsable pictures, press to display the browser screen.
Numbers	Highlights a numbered menu option (some discs only). Press ENTER to select (or wait a few seconds).

Button	What it does
↶ (RETURN)	Displays the PBC menu.
Numbers	Use to enter a numbered menu option. Press ENTER to select (or wait a few seconds).
◀◀	Displays the previous menu page (if there is one).
▶▶	Displays the next menu page (if there is one).



FAQ

- *After I load a DVD disc, it ejects automatically after a few seconds!*

Most likely, the disc is the wrong region for your player. The region number should be printed on the disc; check it against the region number of the player (which you can find on the rear panel). See also *DVD-Video regions* on page 13.

If the region number is OK, it may be that the disc is damaged or dirty. Clean the disc and look for signs of damage. See also *Taking care of your player and discs* on page 79. Check also that the disc is aligned properly in the disc tray and that it's loaded label-side up.

- *Why won't the disc I loaded play?*

First check that you loaded the disc the right way up (label side up), and that it's clean and not damaged. See *Taking care of your player and discs* on page 79 for information on cleaning discs.

If a disc loaded correctly won't play, it's probably an incompatible format or disc type, such as DVD-ROM. See *Disc / content format playback compatibility* on page 11 for more on disc compatibility.

- *There's no picture!*

Check the front panel and make sure that the **PURE AUDIO** indicator isn't lit. If it is, press the **PURE AUDIO** button to switch the video and HDMI outputs back on. See also *Front panel* on page 25.

Also make sure that if your TV isn't compatible with progressive scan video, that the **PROGRESSIVE** indicator isn't lit. If it is, press the **PROGRESSIVE** button to switch the video output back to interlace. See also *Front panel* on page 25.

- *I have a widescreen TV so why are there black bars at the top and bottom of the screen when I play some discs?*

Some movie formats are such that even when played on a widescreen TV, black bars are necessary at the top and bottom of the screen. This is not a malfunction.

- *I have a standard (4:3) TV and set the player to show widescreen DVDs in pan & scan format, so why do I still get black bars top and bottom with some discs?*

Some discs override the display preferences of the player, so even if you have **4:3 (Pan & Scan)** selected, those discs will still be shown in letterbox format. This is not a malfunction.

- *My DVD-Audio disc starts playing, but then suddenly stops!*

The disc may have been illegally copied.

- *My CD with MP3 tracks won't play!*

Make sure that the tracks are encoded in MPEG1 audio layer 3 format. See also *Compressed Audio Compatibility* on page 12.

- *Some MP3 tracks don't show up. Where are they?*

Filenames that don't end with the extension ".mp3" won't be recognized by this player. Also, if there are more than 250 folders or tracks on the disc, only the first 250 are recognized. See also *Compressed Audio Compatibility* on page 12.

- *There's no sound from the analog/optical/coaxial outputs or the HDMI interface!*

Check the front panel and make sure that the **PURE AUDIO** indicator isn't lit. If it is, press the **PURE AUDIO** button to switch the digital audio (optical/coaxial and HDMI) outputs back on.

You won't hear any sound from the HDMI output if the source component is only DVI/HDCP-compatible.

If the i.LINK interface is active, all other audio outputs are switched off. You can check by looking at the i.LINK indicator on the front panel. If it's lit then the player is outputting audio over i.LINK. See *Audio Out* on page 77 for how to switch it off.

- *My AV receiver is definitely compatible with 96/88.2kHz Linear PCM audio, but it doesn't seem to work with this player. What's wrong?*

For digital copy-protection purposes, some 96/88.2kHz DVD discs only output digital audio downsampled to 48/44.1kHz through the optical and coaxial outputs. This is not a malfunction. To fully take advantage of the high sampling rate audio, connect the analog audio outputs to your amplifier/receiver.

- *Why can't I hear SACD audio through the optical/coaxial digital outputs or the HDMI interface?*

SACD audio is only available through the analog outputs and the i.LINK connector. This is not a malfunction. Also, some DVD-Audio discs only output audio through the analog outputs and i.LINK connector.

- *Why does the volume level seem lower during SACD playback?*

Compared to CDs, SACD audio may seem slightly lower in volume due to this player specification.

- *Is it better to listen to DVD-Audio discs through the analog outputs?*

Some DVD-Audio discs do not output anything through the digital outputs, and multichannel discs are downmixed to stereo for the optical and coaxial digital outputs. In addition, high sampling rate DVD-Audio discs (96kHz or higher) automatically downsample audio output from the optical/coaxial digital outputs.

Using the multichannel analog audio outputs or the i.LINK connector for DVD-Audio have none of these limitations.

- *I've connected to a HDMI/DVI compatible component but I can't get any signal and the front panel HDMI indicator won't light!*

Make sure that you've selected this player as the HDMI input in the settings for the component you're using. You may need to refer to the instruction manual of the component to do this.

An HDMI connection can only be made with components compatible with both DVI and High Bandwidth Digital Content Protection (HDCP). See *Connecting using HDMI* on page 22 for more on HDMI compatibility.

- *There's no picture from the HDMI output!*
Depending on the source material, you may not be able to get a picture from DVI-compatible sources. DVI sources must also be encoded using High Bandwidth Digital Content Protection (HDCP) for you to see a picture using this player. See *Connecting using HDMI* on page 22 for more on HDMI compatibility.

Make sure the resolution on this player matches that of the component you have connected using HDMI. See *HDMI Settings* on page 71 to change the HDMI resolution.

Chapter 5

Playing discs

Introduction

Most of the features described in this chapter make use of on-screen displays. For an explanation of how to navigate these, see *Using the on-screen displays* on page 32.

Many of the functions covered in this chapter apply to DVD and SACD discs, Video CDs, CDs and MP3 discs, although the exact operation of some varies slightly with the kind of disc loaded.

Some DVD discs restrict the use of some functions (random or repeat, for example). This is not a malfunction.

When playing Video CDs, some of the functions are not available during PBC playback. If you want to use them, start the disc playing using a number button to select a track.

Using the Disc Navigator to browse the contents of a disc

Use the Disc Navigator to browse through the contents of a disc to find the part you want to play. You can use the Disc Navigator when a disc is playing or stopped.



Important

- It's not possible to use the Disc Navigator when playing a Video CD in PBC mode, or when a DVD disc menu is displayed.

1 Press HOME MENU and select 'Disc Navigator' from the on-screen display.

Alternatively, if a DVD-RW, CD, Video CD or MP3 disc is loaded, you can press **MENU**, which takes you straight to the Disc Navigator screen.

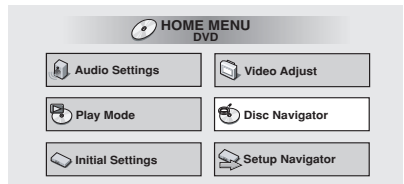

2 Select what you want to play.

Depending on the type of disc you have loaded, the Disc Navigator looks slightly different.

For DVD-Video discs select a title, or a chapter within a title.

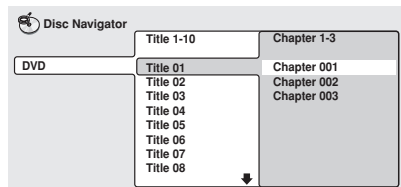

For DVD-Audio discs select a group, or a track within a group.

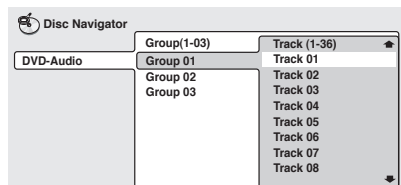

For SACD discs select a track within the current playback area.

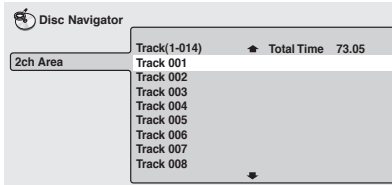

For a VR mode DVD-RW disc select between the Playlist and Original areas of the disc, or a title. Use the joystick (right) to preview the title.

- It's not possible to switch between Original and Playlist during playback.
- Not all DVD-RW discs have a Playlist.

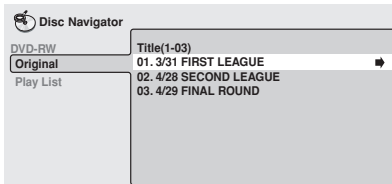

For CDs and Video CDs select a track (the screen below shows a CD loaded).

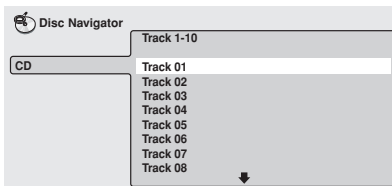

For MP3 discs select a folder, or a track within a folder. (Note that if a folder or track name contains accented or non-roman characters, they may show up with generic names – F_033, T_035, etc.).

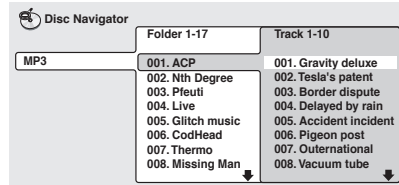

Playback starts after you press **ENTER**.

Tip

- The Disc Navigator is not available unless there is a disc loaded.
- Another way to find a particular place on a disc is to use one of the search modes. See *Searching a disc* on page 50.

Scanning discs

You can fast-scan discs forward or backward at various speeds.

- 1 During playback, press ◀◀ or ▶▶ to start scanning.**
- 2 Press repeatedly to increase the scanning speed.**
 - MP3s can only be scanned at one speed.
 - The scanning speed is shown on-screen.
- 3 To resume normal playback, press ▶ (play).**

Note

- Sound can be heard while scanning SACDs, audio CDs, and MP3 discs.
- There is no sound while scanning DVDs and Video CDs, and no subtitles while scanning DVD-Video.
- Depending on the disc, normal playback may automatically resume when a new chapter is reached on a DVD-Video disc.

Using the Multi Dial

You can use the Multi Dial to control fast and slow motion scanning and frame advance of DVD-Video, DVD-R/RW and Video CDs.

When scanning, no audio is output, even when the scanning speed is 1/1 (normal playback speed).

- **To start scanning playback at 1/16 speed, turn the MULTI DIAL (clockwise for forward; anti-clockwise for reverse) during playback.**

- Turn the **MULTI DIAL** in the same direction to increase the scan speed—the speed is indicated at the top left of the screen.
- Turn in the opposite direction to slow the scan speed/reverse direction.

- **To start high-speed scanning, turn the MULTI DIAL quickly (clockwise for forward; anti-clockwise for reverse) during playback.**

- Change the speed/direction in the same way as above.
- To resume normal playback, press ►.

- **To start manual scanning, press JOG (JOG MODE), then use the MULTI DIAL to advance frames in either direction.**

- **To switch off jog mode, press JOG (JOG MODE) again. The picture remains paused until you restart playback.**

- To resume normal playback, press ►.



Note

- You can scan Video CDs in the same way as DVD-Video discs (see above). However, reverse slow-motion scanning is not possible, and there are just two fast scanning speeds.

Playing in slow motion

You can play DVD-Videos, DVD-R/RW and Video CDs at four different forward slow motion speeds, and DVD-Videos, DVD-R/RW also at two reverse speeds.

- 1 During playback, press II (pause).**

- 2 Press and hold ◀I/◀II or II▶/I▶ until slow motion playback starts.**

- The slow motion speed is shown on-screen.
- There is no sound during slow motion playback.

- 3 Press repeatedly to change the slow motion speed.**

- The slow motion speed is displayed on-screen.

- 4 To resume normal playback, press ► (play).**



Note

- You can't use slow motion playback with some titles on some DVDs.
- Video CD only supports forward slow motion playback.
- The picture quality during slow motion playback is not as good as during normal playback.
- Depending on the disc, normal playback may automatically resume when a new chapter is reached.
- For DVD-Audio discs featuring browsable pictures (see the *Glossary* on page 87), press ◀I/◀II / II▶/I▶ to view the previous/next picture.

Frame advance/frame reverse

You can advance or back up DVD-Video or DVD-RW discs frame-by-frame. With Video CDs, you can only use frame advance.

1 During playback, press II (pause).

2 Press ◀|/◀|| or |||/▶ to reverse or advance a frame at a time.

3 To resume normal playback, press ▶ (play).



Note

- The picture quality when using frame reverse is not as good as frame advance.
- Depending on the disc, normal playback may automatically resume when a new chapter is reached.
- When changing direction of a DVD-Video disc, the picture may 'move' in an unexpected way. This is not a malfunction.
- For DVD-Audio discs featuring browsable pictures (see the *Glossary* on page 87), press ◀|/◀|| /|||/▶ to view the previous/next picture.

Looping a section of a disc

The A-B Repeat function allows you to specify two points (A and B) within a track (DVD-Audio, CD and Video CD) or title (DVD-Video and DVD-RW) that form a loop which is played over and over.



Important

- A-B Repeat is not available with SACDs, MP3s, or Video CDs in PBC mode, or while a DVD disc menu is being displayed.

1 During playback, press PLAY MODE and select 'A-B Repeat' from the list of functions on the left.

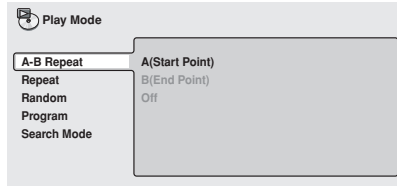

2 Press ENTER on 'A(Start Point)' to set the loop start point.

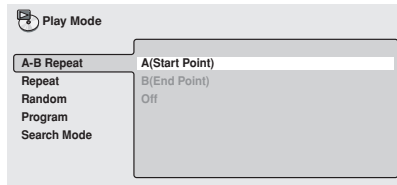

3 Press ENTER on 'B(End Point)' to set the loop end point.

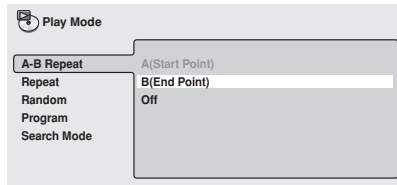

After pressing **ENTER**, playback jumps back to the start point and plays the loop.

4 To resume normal playback, press CLEAR or select 'Off' from the menu.

Using repeat play

There are various repeat play options, depending on the kind of disc loaded. It's also possible to use repeat play together with program play to repeat the tracks/chapters in the program list (see *Creating a program list* on page 47).



Important

- Repeat play is not available with Video CDs in PBC mode, or while a DVD disc menu is being displayed.

1 During playback, press PLAY MODE and select 'Repeat' from the list of functions on the left.

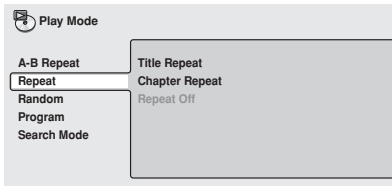

2 Select a repeat play option.

The repeat play options available depend on the type of disc loaded. The screen below appears when a DVD-Video disc is loaded.

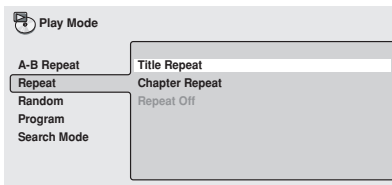

DVD-Video and DVD-RW discs

- **Title Repeat**
- **Chapter Repeat**
- **Repeat Off**

DVD-Audio discs

- **Group Repeat**
- **Track Repeat**
- **Repeat Off**

SACD, CD and Video CD discs

- **Disc Repeat**
- **Track Repeat**
- **Repeat Off**

MP3 discs

- **Disc Repeat**
- **Folder Repeat**
- **Track Repeat**
- **Repeat Off**



Tip

- If you've made a program list, the **Program Repeat** option also appears as a repeat option.
- To stop the disc and cancel repeat play, press **■** (stop).
- You can also cancel repeat play without stopping playback by pressing **CLEAR**. The disc will play to the end, then stop.



Note

- You can't use repeat and random play at the same time.
- If you switch camera angle during repeat play, repeat play is canceled.

Using random play

Use the random play function to play titles or chapters (DVD-Video), groups or tracks (DVD-Audio), or tracks (CD, Video CD/ and MP3 discs) in a random order.

You can set the random play option when a disc is playing or stopped.



Important

- You can't use random play with SACDs, DVD-RWs, Video CDs playing in PBC mode, or while a DVD disc menu is being displayed.

1 Press PLAY MODE and select 'Random' from the list of functions on the left.

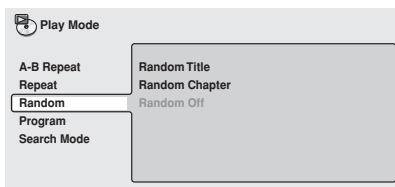

2 Select a random play option.

The random play options available depend on the type of disc loaded. The screen below appears when a DVD-Video disc is loaded.

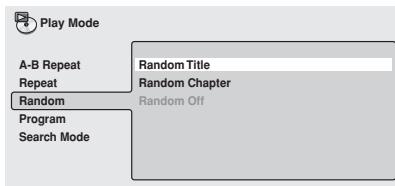

DVD-Video discs

- Random Title
- Random Chapter
- Random Off

DVD-Audio discs

- Random Group
- Random Track
- Random Off

MP3, CD and Video CD discs

- On
- Off



Tip

- To stop the disc and cancel random playback, press ■ (stop).
- You can also cancel random playback without stopping the disc by pressing CLEAR. The disc will play to the end, then stop.
- During random play, the ◀◀ and ▶▶ buttons function a little differently to normal: ◀◀ returns to the beginning of the current track/chapter. You can't go back further than this. ▶▶ selects another track/chapter at random from those remaining.
- You can't use random play together with program or repeat play.

Creating a program list

This feature lets you program the play order of titles/group/chapters/folders/tracks on a disc.



Important

- Program play is not available with DVD-RWs, Video CDs playing in PBC mode, or while a DVD disc menu is being displayed.

1 Press PLAY MODE and select 'Program' from the list of functions on the left.

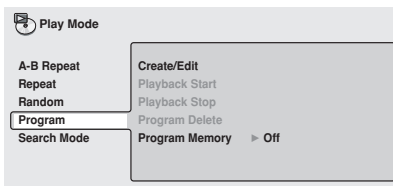

2 Select 'Create/Edit' from the list of program options.

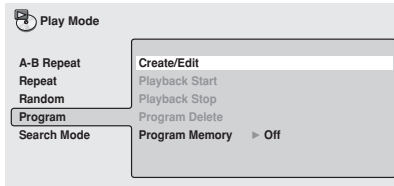

The Program edit screen that appears depends on the kind of disc loaded.

On the left side is the program list, then to the right is a list of titles (if a DVD-Video disc is loaded), groups (for DVD-Audio), tracks (for SACDs, CDs and Video CDs), or folders (for MP3 discs). On the far right is a list of chapters (for DVD-Video) or tracks (for DVD-Audio and MP3).

3 Select a title, chapter, group or track for the current step in the program list.

For a DVD disc, you can add a whole title, or a chapter within a title to the program list.

- To add a title, select the title.

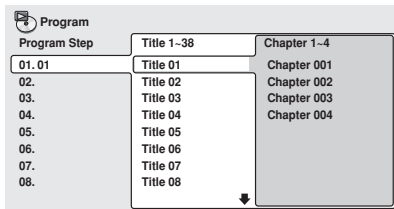

- To add a chapter, first highlight the title, then move the cursor right and select a chapter from the list.

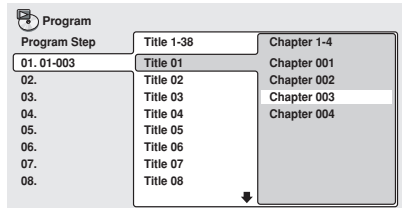

For a DVD-Audio disc, you can add a whole group, or a track within a group to the program list.

- To add a group, select the group.

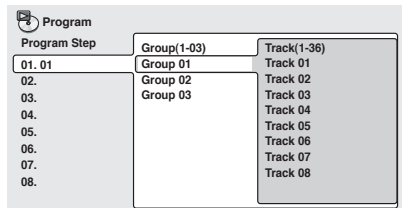

- To add a track, first highlight the group, then move the cursor right and select a track from the list.

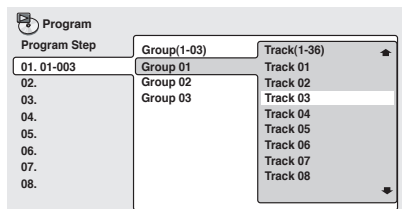

For SACD, CD or Video CD, select a track to add to the program list. (The screen below shows a CD loaded.)

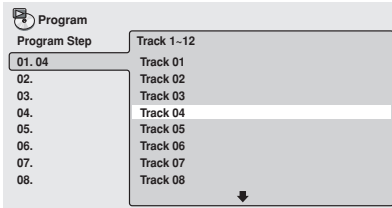

For an MP3 disc, you can add a whole folder, or a track within a folder to the program list.

- To add a folder, select the folder.

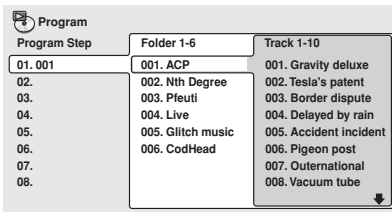

- To add a track, first find the folder, then move the cursor right and select a track name from the list.

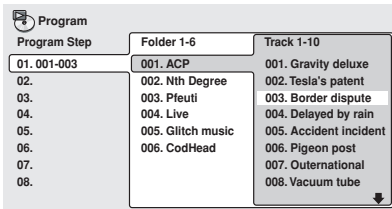

After pressing **ENTER** to select the title/group/chapter/folder/track, the step number automatically moves down one.

4 Repeat step 3 to build up a program list.

A program list can contain up to 24 titles/chapters/groups/folders/tracks.

5 To play the program list, press ► (play).

Program play remains active until you turn off program play (see below), erase the program list (see below), eject the disc or switch off the player.



Tip

- To exit the program edit screen without starting playback, press **PLAY MODE** or **HOME MENU**. (Don't press **RETURN**—your program list will be lost.)
- During program play, press **▶▶** to skip to the next program step.
- Press **CLEAR** during playback (though not if the program list OSD is displayed) to switch off program play. Press while stopped to erase the program list.

Editing a program list

After creating a program list, you can add, delete and change steps.

1 Press **PLAY MODE** and select 'Program' from the list of functions on the left.

2 Select 'Create/Edit' from the list of program options.

3 To clear a step, highlight the step number and press **CLEAR**.

4 To insert a step in the middle of the program list, highlight the step where you want the new step to appear, then select a title/group/chapter/folder/track to add.

After pressing **ENTER**, the new step is inserted into the list.

5 To add a step to the end of the program list, highlight the next free step then select a title/group/chapter/folder/track to add.



Tip

- To exit the program edit screen without starting playback, press **PLAY MODE** or **HOME MENU**.
- If you want to exit the program edit screen without saving the changes you made, press **RETURN**.

Other functions available from the program menu

As well as creating and editing a program list, you can start and stop program play, erase the program list, and memorize a DVD program list from the Program menu.

1 Press **PLAY MODE** and select 'Program' from the list of functions on the left.

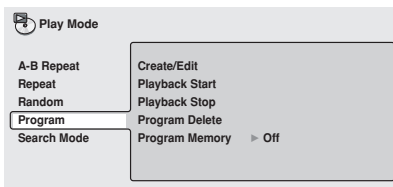

2 Select a program play function.

- **Create/Edit** – See *Creating a program list* on page 47
- **Playback Start** – Starts playback of a saved program list
- **Playback Stop** – Turns off program play, but does not erase the program list
- **Program Delete** – Erases the program list and turns off program play
- **Program Memory (DVD-Video only)** – Select **On** to save the program list for the disc loaded. (Select **Off** to cancel the program memory for the disc loaded)



Tip

- After saving a program list using the Program Memory feature, whenever you load that disc, the program list is automatically recalled and program play switched on.
- You can save program lists for up to 24 discs. After that, the oldest one is replaced with the new one saved.

Searching a disc

Using the search mode function from the Play Mode menu you can quickly jump to a particular part of the disc that you're watching or listening to.

1 Press **PLAY MODE** and select 'Search Mode' from the list of functions on the left.

The search options that appear depend on the kind of disc loaded. The screen below shows the DVD-Video search options.

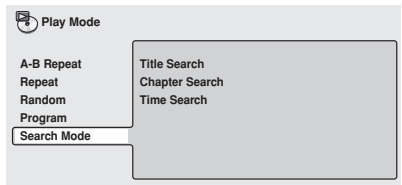

2 Select a search mode.

3 Use the number buttons to enter a title, group, chapter, folder or track number, or a time.

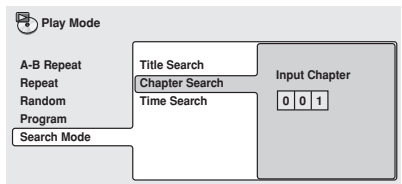

- For a time search, enter the number of minutes and seconds into the currently playing title (DVD-Video/DVD-RW) you want playback to resume from. For example, press **4, 5, 0, 0** to have playback start from 45 minutes into the disc. For 1 hour, 20 minutes and 30 seconds, press **8, 0, 3, 0**.
- Some DVD-Audio discs feature pages of browsable pictures. Enter the page number you want.

4 Press ENTER to start playback.



Note

- You can only use time search with Video CDs and DVD-Video discs.
- Discs must be playing in order to use time search (except Video CD).
- Search functions are not available with Video CD in PBC mode (start non-PBC playback by stopping playback, then pressing ►►I, then ► (play)).
- You can often select what you want to watch from a DVD disc menu. See also *DVD disc menus* on page 38.

Switching subtitles

Some DVD discs have subtitles in one or more languages; the disc box will usually tell you which subtitle languages are available. You can switch subtitle language during playback.

1 Press SUBTITLE repeatedly to select a subtitle option.

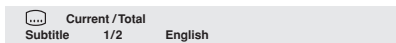

- While the above display is showing, you can also use the joystick (up/down) and **ENTER** to select a subtitle language from a drop-down menu.

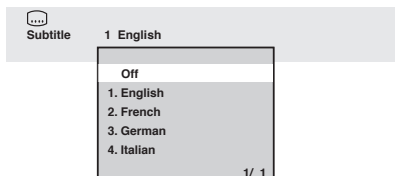

Note

- Some discs only allow you to change subtitle language from the disc menu. Press **TOP MENU** to access.
- To set subtitle preferences, see *Subtitle Language* on page 65.

Switching the DVD audio language

When playing a DVD disc recorded with dialog in two or more languages, you can switch audio language during playback.

1 Press AUDIO repeatedly to select an audio language option.



- With some discs, while the above display is showing, you can also use the joystick (up/down) and **ENTER** to select an audio language from a drop-down menu.

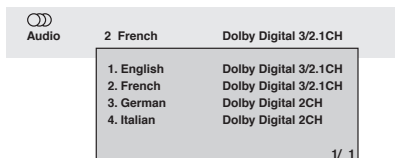

**Note**

- Some discs only allow you to change audio language from the disc menu. Press **TOP MENU** to access.
- To set audio language preferences, see *Audio Language* on page 64.

Switching DVD-RW audio channels

When playing a DVD-RW disc recorded with dual-mono audio, you can switch between the main, sub, and mixed channels during playback.

- 1 Press **AUDIO** repeatedly to select an audio channel option.



Switching DVD-Audio audio channels

Depending on the disc, you may be able to switch channels when playing DVD-Audio discs—see the disc box for details.

- 1 Press **AUDIO** repeatedly to select an audio channel option.

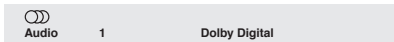

Switching CD/MP3/Video CD audio channels

You can switch between stereo, just the left channel or just the right channel of a CD/MP3/Video CD. (To change the audio channel of a CD it must be playing.)

- 1 Press **AUDIO** repeatedly to select an audio channel option.

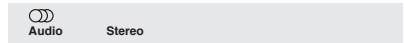

Switching camera angles

Some DVD discs feature scenes shot from two or more angles—check the disc box for details.

When a multi-angle scene is playing, a  icon appears on screen to let you know that other angles are available (this can be switched off if you prefer—see *Angle Indicator* on page 66).

- During playback (or when paused), press **ANGLE** to switch angle.

Displaying disc information

Various track, chapter and title information, as well as the video transmission rate for DVD discs, can be displayed on-screen.

- 1 During playback, press **DISPLAY** to show/switch the information displayed. Keep pressing **DISPLAY** to change the displayed information.

- DVD-Video displays

Play		▶ DVD			
	Current / Total	Elapsed	Remain	Total	
Title	11/38	2.05	4.57	7.02	
Track	1. French	1. English	Subtitle	Angle 1	
Audio	Dolby Digital 3/2.1CH				

Play		▶ DVD			
Chapter	Current / Total	Elapsed	Remain	Total	
Chapter	11/38	2.05	4.57	7.02	
Tr. Rate	8.6Mbps				

The # mark displayed with some DVD-Video discs means that the video is playing at 24 frames/second, progressive.

Pause		▶ DVD			
Chapter	Current / Total	Elapsed	Remain	Total	
Chapter	2/35	0.06 15	1.40	1.46	
Tr. Rate :	6.0Mbps				

When the disc is paused, the display also shows the frame number.

- DVD-Audio displays

Play		▶ DVD-Audio			
Track	Current / Total	Elapsed	Remain	Total	
Track	1/14	3.20	2.41	6.01	
Audio	1 Linear PCM 192kHz 24bit 2/0CH	Subtitle	--	Angle 1	

Play		▶ DVD-Audio			
Group	Current / Total	Elapsed	Remain	Total	
Group	1/3	3.21	53.20	56.41	
Tr. Rate :	9.5Mbps				

- DVD-RW displays

Play		▶ DVD-RW Original			
Title	Current / Total	Elapsed	Remain	Total	
Title	1/32	0.08	30.22	30.30	
Track	1	Subtitle	--		
Audio	Dolby Digital 2/0CH				

Play		▶ DVD-RW Original			
Chapter	Current / Total	Elapsed	Remain	Total	
Chapter	1/1				
Tr. Rate	4.3Mbps				

- SACD displays

Play		▶ SACD			
Track	Current / Total	Elapsed	Remain	Total	
Track	1/14	0.13	4.21	4.34	

(During multichannel playback only)

Play		▶ SACD			
Track	Current / Total	Elapsed	Remain	Total	
Track	1/9	0.22	3.38	4.00	
Audio	3/2.1CH				

Play		▶ SACD			
Disc	Elapsed	Remain	Total		
Disc	0.05	73.00	73.05		

- CD and Video CD Displays

Play		▶ CD			
Track	Current / Total	Elapsed	Remain	Total	
Track	2/16	1.07	4.40	5.47	

Play		▶ CD			
Disc	Elapsed	Remain	Total		
Disc	28.00	30.20	58.20		

(During PBC playback only)

Play		▶ VCD			
------	--	-------	--	--	--

- MP3 disc displays

Play		▶ MP3			
Track	Current / Total	Elapsed	Remain	Total	
Track	1/17	0.18	12.42	13.00	
Track Name	Outernational				

Play		▶ MP3			
Folder	Current / Total	Elapsed	Remain	Total	
Folder	2/7				
Folder Name	ACP				

**Tip**

- You can see disc information (number of titles/chapters, groups, tracks, folders and so on) from the Disc Navigator screen. See *Using the Disc Navigator to browse the contents of a disc* on page 42.

Chapter 6

Audio Settings menu

Note about features in the Audio Settings menu

None of the features found in the Audio Settings menu have any effect on sound output through the i.LINK connector.

Audio DRC

- Default setting: **Off**

When watching Dolby Digital DVDs at low volume, it's easy to lose the quieter sounds completely—including some of the dialog. Switching Audio DRC (Dynamic Range Control) to On can help by bringing up the quieter sounds, while controlling loud peaks.

How much of a difference you hear depends on the material you're listening to. If the material doesn't have wide variations in volume, you may not notice much change.

- 1 Press **HOME MENU** and select 'Audio Settings' from the on-screen display.

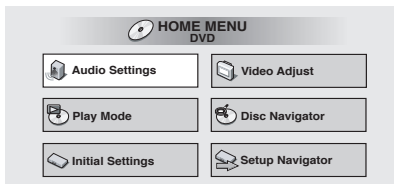

- 2 Highlight Audio DRC, then use the Joystick (left/right) to change to 'On' or 'Off' as required.

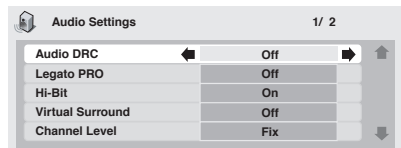

- 3 Press **ENTER** to make the setting and exit the Audio Settings screen.

Note

- Audio DRC is only effective with Dolby Digital audio sources.
- Audio DRC is only effective through the digital output when **Digital Out** is set to **On**, and **Dolby Digital Out** (see page 62) is set to **Dolby Digital > PCM**.
- The effect of Audio DRC depends on your speakers and AV receiver settings.

Legato PRO

- Default setting: **Off**

Legato PRO technology can reveal more high-frequency detail in CDs and DVDs by upsampling.

- 1 Press **HOME MENU** and select 'Audio Settings' from the on-screen display.

2 Highlight 'Legato PRO', then use the Joystick (left/right) to change the setting.

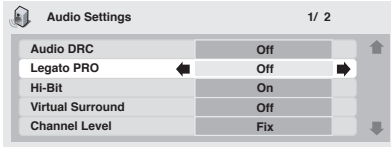

There are four settings, plus **Off**.

- **Off**
- **Standard** – gives the sound a more forward, live feel
- **Effect 1** – bright and lively
- **Effect 2** – soft and rich
- **Effect 3** – solid and well-balanced

3 Press ENTER to make the setting and exit the Audio Settings screen.



Note

- The Legato PRO digital filter affects mainly frequencies outside of the audible range.
- Depending on the listening conditions, you may find that the effect of Legato PRO difficult to hear.
- The Legato PRO effect is applied only to the front left/right channels.
- Legato PRO does not work with 192kHz DVD-Audio discs, or with SACDs.

Hi-Bit

- Default setting: **On**

The Hi-Bit feature extends the effective dynamic range of the front left/right channels from 16 or 20-bit to 24-bit to reveal more detail in low-level sounds.

1 Press HOME MENU and select 'Audio Settings' from the on-screen display.

2 Highlight 'Hi-Bit', then use the Joystick (left/right) to change the setting to 'On' or 'Off', as required.

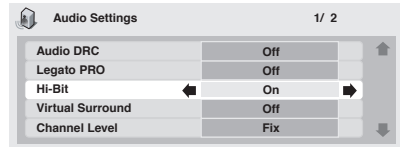

3 Press ENTER to make the setting and exit the Audio Settings screen.

Virtual Surround

- Default setting: **Off**

Switch on Virtual Surround to enjoy surround sound effects from just two speakers.

When you play a Dolby Digital or Pro Logic encoded source, TruSurround technology from SRS produces a deep, realistic 3D soundspace from a pair of stereo speakers. SRS TruSurround is a process certified by Dolby Laboratories for Virtual Dolby Digital sound.

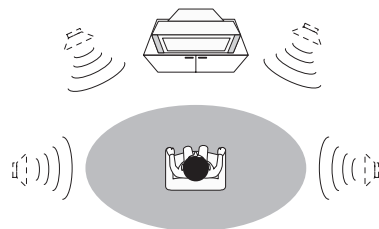

- 1 Press HOME MENU and select 'Audio Settings' from the on-screen display.
- 2 Highlight Virtual Surround, then use the Joystick (left/right) to change to 'Dolby/SRS TruSurround' or 'Off', as required.

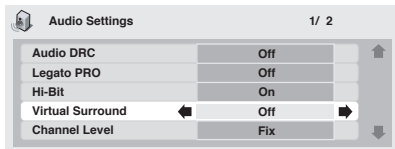

- 3 Press ENTER to make the setting and exit the Audio Settings screen.



Tip

- You can also use the **SURROUND** button on the remote control to switch Virtual Surround on (Dolby/SRS TruSurround)/Off.



Note

- Virtual Surround does not work with CD, MP3, DVD-Audio or SACD discs, or 96kHz Linear PCM soundtracks.
- The Virtual Surround effect is output only through the analog **AUDIO OUT (2ch)** jacks.
- Make sure that **Audio Output Mode** is set to **2 Channel** (see *Audio Output Mode* on page 74).
- How good the surround effect is varies with the disc.

Channel Level

- Default setting: **Fix**

This setting allows you to set the level of each channel sent to the 5.1 channel analog outputs.

- 1 Press HOME MENU and select 'Audio Settings' from the on-screen display.
- 2 Highlight Channel Level, then use the Joystick (left/right) to change to 'Fix' or 'Variable', as required.

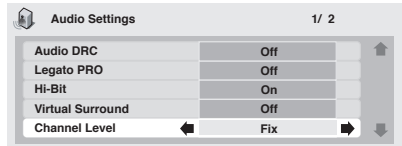

- **Fix** – Channel levels are fixed, but you can set the speaker distances
- **Variable** – You can specify variable channel levels as well as speaker distances

- 3 If you chose Variable, use the joystick (down) to proceed to the next screen.

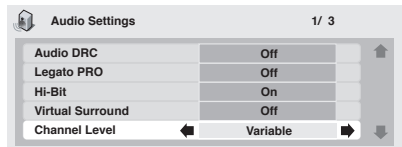

- 4 **Variable setting only:** Set the channel levels for each speaker.

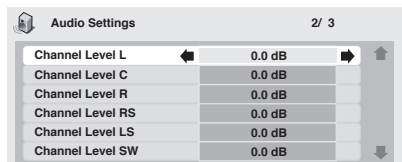

- Use the Joystick (up/down) to select a speaker.
- Use the Joystick (left/right) to adjust the channel level for that speaker.

Channel levels can be set from -6 dB to +6 dB, in 0.5 dB increments.

5 Press ENTER to make the settings and exit the audio settings screen.



Note

- You can't adjust the channel level for any speakers that are set to **Off** in the **Speaker Installation** menu screen (see *Speaker Installation* on page 74).
- The **Fix** setting is equivalent to setting all the channel levels to **+6 dB**. Therefore, the **Variable** setting will usually sound quieter than the **Fix** setting.

Speaker Distance

- Default setting: all speakers **10ft.**

To get the best surround sound from your system, you should set up the speaker distances from your listening position.

1 Press HOME MENU and select 'Audio Settings' from the on-screen display.

2 Move the cursor down until you reach the Speaker Distance setting screen.

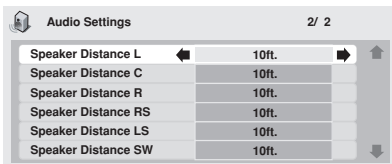

- Use the joystick (up/down) to select a speaker.

- Use the joystick (left/right) to adjust the distance from your listening position to that speaker.

Front left/right (**L/R**) speaker distances can be set from 1ft. to 30ft. in 0.5 ft. increments.

The center speaker (**C**) and subwoofer (**SW**) can be set from -6.5 ft. to +6.5 ft. relative to the front left/right speakers.

Surround left/right (**LS/RS**) speakers can be set from -20 ft. to +6.5 ft. relative to the front left/right speakers.

When you adjust the front left (**L**) or front right (**R**) speaker, all the other speaker distances are adjusted relative to that speaker.

3 Press ENTER to make the settings and exit the audio settings screen.



Note

- The speaker distance settings have no effect on SACD playback. The channel level settings, however, do apply.

Chapter 7

The Video Settings menu

Video Adjust

- Default setting: **Professional** or (when connected using HDMI) **Direct**

From the Video Adjust screen you can select the standard video presentation or define presets of your own.

1 Press HOME MENU and select 'Video Adjust' from the on-screen display.

You can also access these settings by pressing **V.ADJ (VIDEO ADJUST)**.

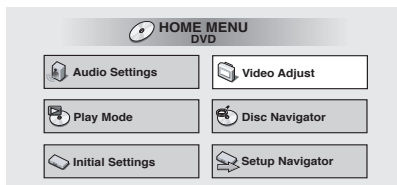

2 Use the joystick (left/right) to select a preset.

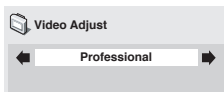

- **TV (CRT)** – Optimized display for a regular CRT TV
- **PDP** – Optimized display for a plasma display screen
- **Professional** – Optimized for a professional video monitor
- **Memory1-3** – Use for saving your own presets (see below)

When the HDMI output is connected, the following options appear instead:

- **Direct** – The picture appears simply according to how the source was encoded.
- **Natural** – Edges are softer making this setting good for movies.
- **Enhanced** – Edges are sharper making this setting ideal for animation and material with computer generated effects.
- **Memory1-3** – Use for saving your own presets (see below)

3 Press ENTER to make the setting and exit the Video Adjust screen.



Note

- Depending on the disc and the TV/monitor, you may not see the effect clearly.

Creating your own presets

You can create up to three presets of your own.

1 Select one of the Memory presets (see above).

2 Use the joystick (down) to select 'Detailed Settings' then press ENTER.

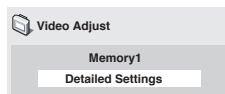

3 Adjust the picture quality settings.

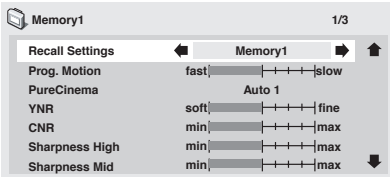

- Use the joystick (up/down) to select a setting.
- Use the joystick (left/right) to adjust the current setting.
- Press **DISPLAY** to switch between full and single view.
- You can recall the preset number from the **Recall Settings** menu item.

You can adjust any or all of the following picture quality settings:

- **Prog. Motion** – Adjusts the motion and still picture quality when the player is set to progressive video output. This has no effect when set to **ON**.
- **PureCinema** – When watching DVD movies, PureCinema optimizes the picture quality. The default setting is **Auto1**, but if the picture appears unnatural, then set to **Auto2**, **ON** or **Off**, as appropriate.
- **YNR** – Adjusts the amount of noise reduction in the Y (brightness) part of the video signal.
- **CNR** – Adjusts the amount of noise reduction in the C (color) part of the video signal.
- **Sharpness High** – Adjusts the sharpness of the high-frequency (detailed) elements in the picture.
- **Sharpness Mid** – Adjusts the sharpness of the mid-frequency (less detailed) elements in the picture.

- **Detail** – Adjusts the sharpness of edges in the picture.
- **White Level** – Adjusts the intensity of white.
- **Black Level** – Adjusts the intensity of black.
- **Black Setup** – Setup to correct the floating black color for better 3-dimensional realism.
- **Gamma** – Adjusts the brightness of darker images.
- **Hue** – Adjusts the overall color balance between red and green.
- **Chroma Level** – Adjusts how saturated colors appear.
- **Chroma Delay** – Adjust to correct the gap between the Y and C components in the video signal.

When the HDMI output is connected, the following options also appear:

- **HDMI Detail** – Adjusts the sharpness of edges in the HDMI video signal.

4 Press ENTER to save the preset and exit the Video Adjust screen.



Note

- Video on a DVD discs may be either video material (originally shot on video) or film material (originally shot on film). Video material has a frame rate of 30 frames/sec.(NTSC), compared with 24 frames/sec. for film. This player converts film material to 60 frames/sec. (in progressive scan mode). PureCinema adjusts the picture so that it matches more closely the picture quality of a cinema screen.

You can see whether video on a DVD disc is film or video material by displaying the video transmission rate (see *Displaying disc information* on page 52). If a hash mark (#) appears next to the transmission rate display, it is film material.

Chapter 8

Initial Settings menu

Using the Initial Settings menu

The Initial Settings menu gives you complete control in setting up your DVD player, including audio, and video output settings, audience limitation settings, among others. If an option is grayed out it means that it cannot be changed at the current time. This is usually because a disc is playing. Stop the disc, then change the setting.

- 1 Press **HOME MENU** and select 'Initial Settings' from the on-screen display.

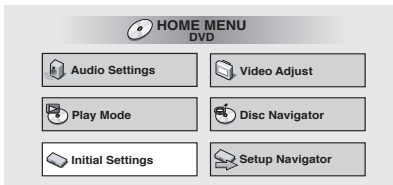

- 2 Select the setup category from the list on the left, then select an item from the menu list to the right.

- 3 Make the setting you want.



Note

- The language options shown in the on-screen display illustrations on the following pages may not correspond to those available in your country or region.

Digital Audio Out settings



Note

- None of the Digital Audio Out settings affect the audio output from the i.LINK interface. For i.LINK settings, see *i.LINK Setup* on page 77.

Digital Out

- Default setting: **On**

You only need to make this setting if you connected this system to an AV receiver (or other component) using one of the digital outputs.

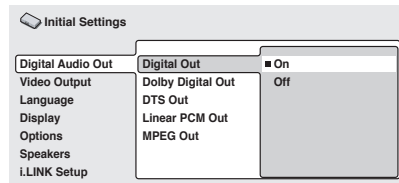

If at any time you need to switch off the digital audio output, set this to Off, otherwise leave it On.



Note

- You can't switch on/off the optical and coaxial outputs individually.
- There is no digital output when playing SACDs and some DVD-Audio discs regardless of this setting.

Dolby Digital Out

- Default setting: **Dolby Digital**

You only need to make this setting if you connected this player to an AV receiver (or other component) using one of the digital outputs.

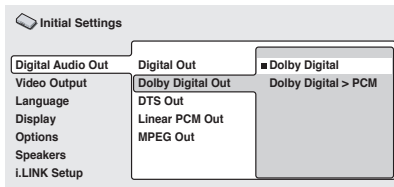

If your AV receiver (or other connected component) is Dolby Digital compatible, set to **Dolby Digital**, otherwise set to **Dolby Digital > PCM**.

DTS Out

- Default setting: **DTS**

You only need to make this setting if you connected this player to an AV receiver (or other component) using one of the digital outputs.

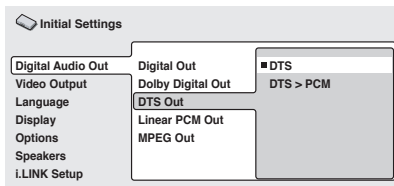

If your AV receiver (or other connected component) has a built-in DTS decoder, set this to **DTS**, otherwise set to **DTS > PCM** (DTS audio is converted to more compatible PCM audio). Check the manual that came with the other component if you're unsure whether it is DTS compatible.



Note

- If you set to **DTS** with a non-DTS compatible amplifier, noise will be output when you play a DTS disc.
- This setting applies only to DTS audio on DVDs. DTS-CD always output DTS digital audio as-is regardless of this setting.

Linear PCM Out

- Default setting: **Down Sample On**

You only need to make this setting if you connected this player to an AV receiver (or other component) using one of the digital outputs.

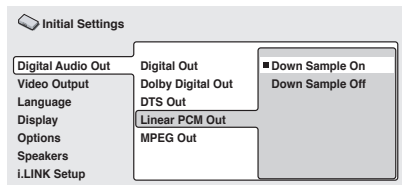

If your AV receiver (or other connected component) is compatible with high sampling rates (96 kHz), set this to **Down Sample Off**, otherwise set it to **Down Sample On** (96 kHz audio is converted to a more compatible 48 kHz). Check the manual that came with the other component if you're unsure whether it is 96 kHz compatible.



Note

- Even when set to **Down Sample Off**, some discs will still output down-sampled audio through the digital outputs (you only get full sampling rate audio through the analog outputs).
- High sampling rate DVD-Audio discs (192kHz or 176.2kHz) automatically output down-sampled audio through the digital outputs.

MPEG Out

- Default setting: **MPEG > PCM**

You only need to make this setting if you connected this player to an AV receiver (or other component) using one of the digital outputs.

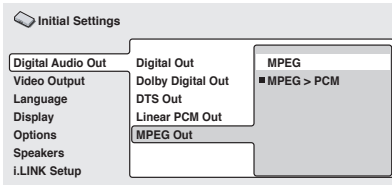

If your AV receiver (or other connected component) is compatible with MPEG audio, set this to **MPEG**, otherwise set it to **MPEG > PCM** (MPEG audio is converted to more compatible PCM audio). Check the manual that came with the other component if you're unsure whether it is MPEG audio compatible.

Video Output settings

TV Screen

- Default setting: **16:9 (Wide)**

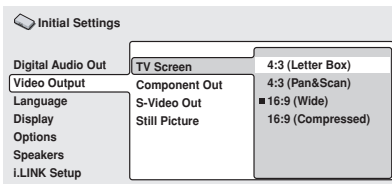

If you have a widescreen TV, select the **16:9 (Wide)** setting—widescreen DVD software is then shown using the full screen area. When playing software recorded in conventional (4:3) format, the settings on your TV will determine how the material is presented—see the manual that came with your TV for details on what options are available.

When set to **16:9(Compressed)**, progressive-scan 4:3 material is shown with black bars on either side of the screen.

If you have a conventional TV, select either **4:3 (Letter Box)** or **4:3 (Pan&Scan)**. In Letter Box mode, widescreen software is shown with black bars at the top and bottom of the screen. Pan & Scan chops the sides off widescreen material to make it fit the 4:3 screen (so even though the image looks larger on the screen, you're actually seeing less of the picture). See also *Screen sizes and disc formats* on page 81.



Note

- You can't change the video output setting when an HDMI component is connected.

Component Out

- Default setting: **Interlace**

You only need to make this setting if you connected this player to your TV using the component video outputs.

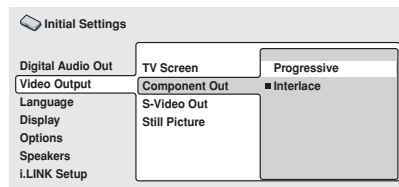

If you have a progressive-scan compatible TV, set this to **Progressive** for flicker-free video output. If your TV is not compatible with progressive-scan video, set to **Interlace**. Check the operating instructions that came with your TV if you're unsure about its compatibility.

**Note**

- This player is compatible with both PAL and NTSC progressive scan formats. However, your TV must also be progressive scan compatible to take advantage of this feature.

S-Video Out

- Default setting: **S2**

You only need to make this setting if you connected this player to your TV using an S-video cable.

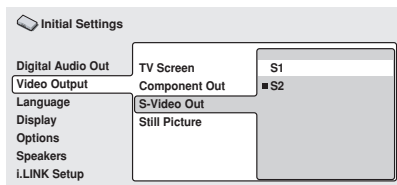

If you find that the picture is stretched or distorted on the default **S2** setting, try changing it to **S1**.

Still Picture

- Default setting: **Auto**

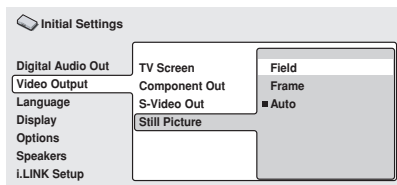

This player uses one of two processes when displaying a still frame from a DVD disc. The default **Auto** setting automatically chooses the best setting each time.

- **Field** – produces a stable, generally shake-free image

- **Frame** – produces a sharper image, but more prone to shake than field stills

Language settings**Note**

- The language options shown in the on-screen display illustrations on the following pages may not correspond to those available in your country or region.

Audio Language

- Default setting: **English**

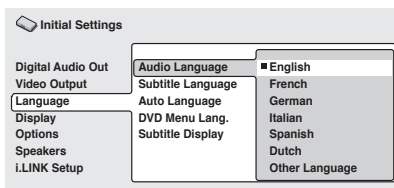

This setting is your preferred audio language for DVD discs. If the language you specify here is recorded on a disc, the player automatically plays the disc in that language.

The DVD format recognizes 136 different languages. Select **Other Language** if you want to specify a language other than those listed. See also *Selecting languages using the language code list* on page 87.

**Tip**

- You can switch between the languages recorded on a DVD disc during playback using the **AUDIO** button. (This does not affect this setting.) See *Switching the DVD audio language* on page 51.

- Some DVD discs set the audio language automatically when loaded, overriding the audio language you set in the Initial Settings menu.
- Discs with two or more audio languages usually allow you to select the audio language from the disc menu. Press **TOP MENU** to access the disc menu.

Subtitle Language

- Default setting: **English**

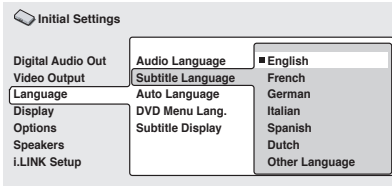

This setting is your preferred subtitle language for DVD discs. If the language you specify here is recorded on a disc, the player automatically plays the disc with those subtitles.

The DVD format recognizes 136 different languages. Select **Other Language** if you want to specify a language other than those listed. See also *Selecting languages using the language code list* on page 87.



Tip

- You can change or switch off the subtitles on a DVD disc during playback using the **SUBTITLE** button. (This does not affect this setting.) See *Switching subtitles* on page 51.
- Some DVD discs set the subtitle language automatically when loaded, overriding the subtitle language you set in the Initial Settings menu.

- Discs with two or more subtitle languages usually allow you to select the subtitle language from the disc menu. Press **TOP MENU** to access the disc menu.

Auto Language

- Default setting: **On**

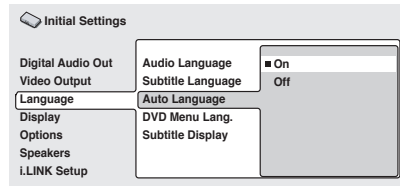

When set to **On**, the player always selects the default audio language on a DVD-Video disc (French dialog for a French movie, for example), and displays subtitles in your preferred subtitle language only if that is set to something different. In other words, movies in your native language won't have any subtitles, while foreign language movies will be shown with subtitles.

Set to **Off** to have the player play discs strictly according to your Audio Language and Subtitle Language settings.

For Auto Language to work, the **Audio Language** and **Subtitle Language** settings must be the same (see *Audio Language* on page 64 and *Subtitle Language* on page 65).



Tip

- You can still switch audio and subtitle language on playback using the **AUDIO** and **SUBTITLE** buttons.

DVD Menu Language

- Default setting: **w/Subtitle Lang.**

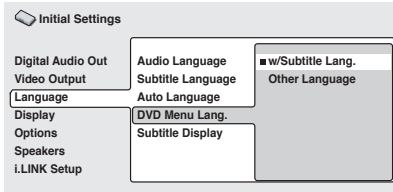

Some multilingual discs have disc menus in several languages. This setting specifies in which language the disc menus should appear. Leave on the default setting for menus to appear in the same language as your **Subtitle Language**—see above.

The DVD format recognizes 136 different languages. Select **Other Language** if you want to specify a language other than those listed. See also *Selecting languages using the language code list* on page 87.

Subtitle Display

- Default setting: **On**

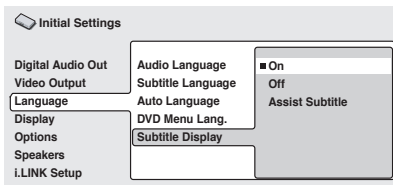

When set to **On**, the player displays subtitles according to the Subtitle Language and Auto Language settings. Set to **Assist Subtitle** to have the player display the extra assistive subtitles recorded onto some DVD discs. Set to **Off** to switch subtitles off altogether.

Display settings

OSD Language

- Default setting: **English**

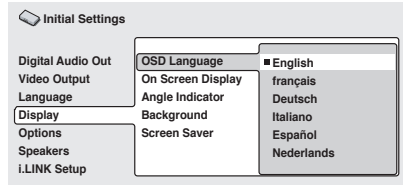

This sets the language of this player's on-screen displays.

On Screen Display

- Default setting: **On**

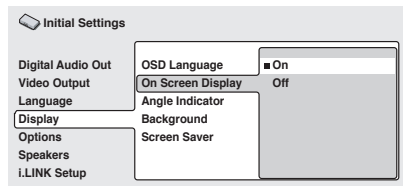

This sets whether operation displays are shown on-screen (**Play**, **Resume**, **Scan** and so on.)

Angle Indicator

- Default setting: **On**

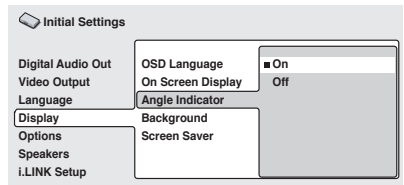

If you prefer not to see the camera icon on-screen during multi-angle scenes on DVD discs, change this setting to **Off**.

Background

- Default setting: **Black**

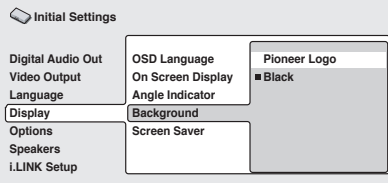

This specifies what is displayed on-screen when the player is stopped.

Screen Saver

- Default setting: **Off**

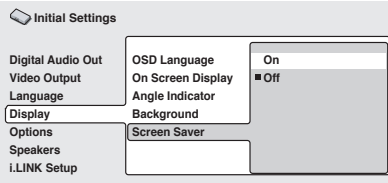

If a constant image is displayed on a conventional CRT-type TV, it can 'burn in' leaving a ghost image on the screen. Switch to On to make sure that a constant image is not displayed for a dangerously long time.

Options

Parental Lock

- Default level: **Off**
- Default password: **none**
- Default Country code: **us (2119)**

Some DVD-Video discs feature a Parental Lock level. If your player is set to a lower level than the disc, the disc won't play. This gives you some control about what your children watch on your DVD player.

Some discs also support the Country code feature. The player does not play certain scenes on these discs, depending on the Country code you set.

Before you can set the Parental Lock level or the Country code you must register a password. As the password owner, you can change the Parental Lock level or Country code whenever you like. You can also change the password.

Note

- Not all discs that you may consider inappropriate for your children use the Parental Lock feature. These discs will always play without requiring the password first.
- If you forget your password, you'll need to reset the player to its factory settings (see *Resetting the player* on page 81), then register a new password.

Registering a new password

You must register a password before you can change the Parental Lock level or enter a Country code.

1 Select 'Password'.

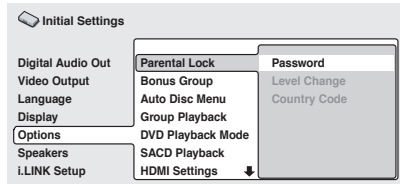

2 Use the number buttons to enter a 4-digit password.

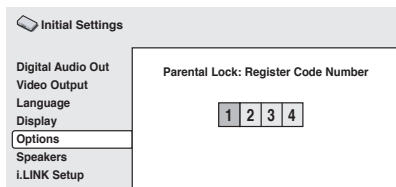

3 Press ENTER to register the password and return to the Options menu screen.

If you forget your password, you can reset the player then register a new one. See *Resetting the player* on page 81 for how to reset the player.

Changing your password

To change your password, confirm your existing password then enter a new one.

1 Select 'Password Change'.

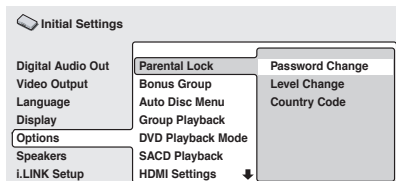

2 Use the number buttons to enter your existing password, then press ENTER.

- The numbers appear as asterisks as you enter them.

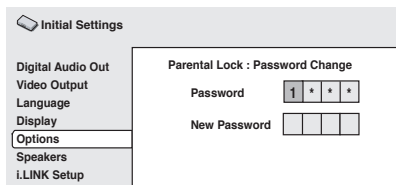

3 Enter a new password.

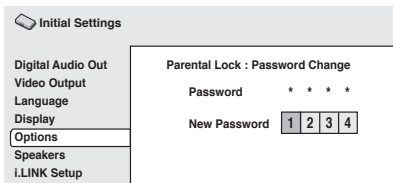

4 Press ENTER to register the new password and return to the Options menu screen.

Setting/changing the Parental Lock level

1 Select 'Level Change'.

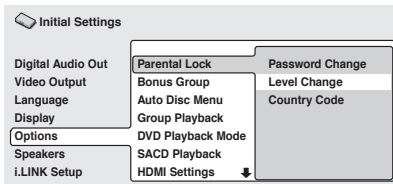

2 Use number buttons to enter your password, then press ENTER.

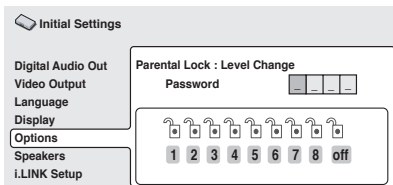

3 Select a new level.

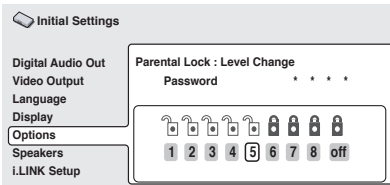

Use the Joystick to move the cursor left to lock more levels (more discs will require the password); move right to unlock levels. You can't lock level 1.

4 Press ENTER to set the new level and return to the Options menu screen.

Setting/changing the Country/Area code

You may also want to refer to the *Country/Area code list* on page 86.

1 Select 'Country Code'.

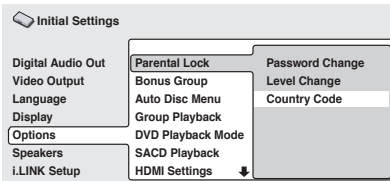

2 Use number buttons to enter your password, then press ENTER.

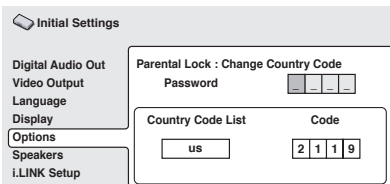

3 Select a Country/Area code.

There are two ways you can do this.

- Select by code letter: Use the Joystick (up/down) to change the Country/Area code.

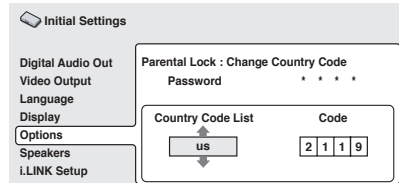

- Select by code number: Use the Joystick to move the cursor right then use the number buttons to enter the 4-digit Country code (you can find the *Country/Area code list* on page 86.)

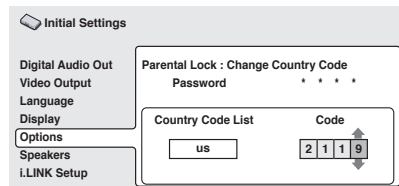

4 Press ENTER to set the new Country/Area code and return to the Options menu screen.



Note

- Changing the Country/Area code does not take effect until the next disc is loaded (or the current disc is reloaded).

Bonus Group

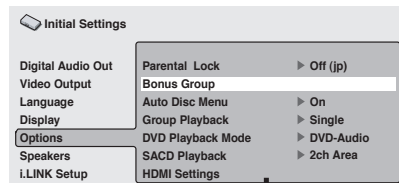

Some DVD-Audio discs have an extra 'bonus' group that requires a 4-digit key number to access. See the disc packaging for details and the key number.

When you play a DVD-Audio disc that has a bonus group, the key number input screen appears automatically. You can also access the same screen here.

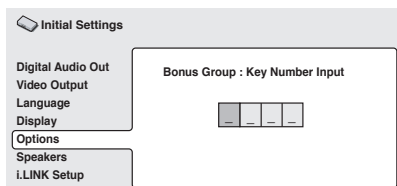

Note

- If you eject the disc, switch the power off, or unplug the player, you will need to re-enter the key number.

Auto Disc Menu

- Default setting: **On**

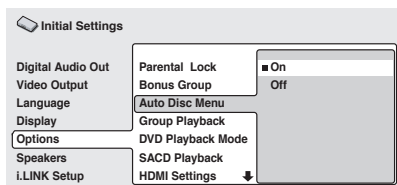

This specifies whether the menu (Top menu) is automatically displayed after loading a disc. Set to **On** if you want the menu displayed automatically, or **Off** if you don't want it displayed.



Note

- Some DVD discs display a menu automatically regardless of this setting. If you press **▶** while a disc is loading, this setting is ignored.

Group Playback

- Default setting: **Single**

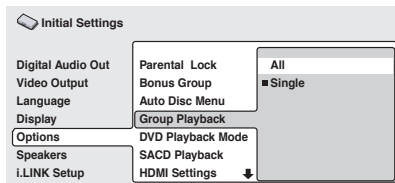

DVD-Audio discs can have up to 9 groups of tracks. When set to **Single**, the selected group plays and then the disc stops, or returns to the menu screen. Use **Group Search** (see *Searching a disc* on page 50) to select the group to play. (You cannot use the track skip **⏮** / **⏭** or scan buttons **⏪** / **⏩** in this mode.)

Set to **All** if you want to play all the groups on a disc consecutively.



Note

- Even if the player is set to **All** but you select a group to play from the disc menu, only that group will play. If you stop playback, all groups will play again when you restart playback.

DVD Playback Mode

- Default setting: **DVD-Audio**

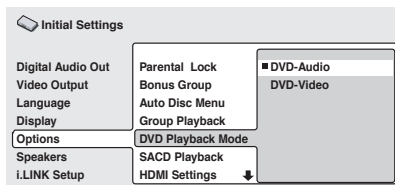

Some DVD-Audio discs contain DVD-Video content in addition to the DVD-Audio. Set to **DVD-Video** to play a DVD-Audio disc as if it were a DVD-Video disc. Note that in this case only the DVD-Video part of the disc will play.

 **Note**

- This setting reverts to **DVD-Audio** (default) when the disc tray is opened, or the power is switched into standby.

SACD Playback

- Default setting: **2ch Area**

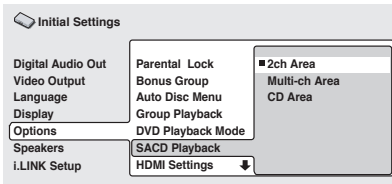

SACD discs can be divided up into several different areas — stereo audio (**2ch Area**), multi-channel audio (**Multi-ch Area**) and, for hybrid SACDs, standard CD audio (**CD Area**). Select which you want to listen to.

 **Note**

- For multi-channel audio from the i.LINK and 5.1 channel analog outputs, SACD playback must be set to **Multi-ch Area**.
- If you select an area that isn't on the disc loaded, a different area of the disc will play. For example, if you choose standard CD audio but the disc loaded is not a hybrid SACD, the stereo SACD audio will play.

HDMI Settings

You only need to make this setting if you connected this player to an HDMI-compatible component using the HDMI connector.

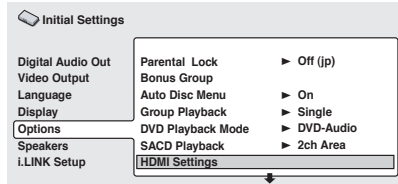

After selecting **HDMI** from the Initial Settings menu, the HDMI settings menu appears. For example, if you connected a Pioneer display, the following menu should be displayed:

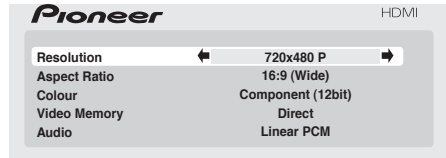

With DVI-compatible devices (with HDCP), the same screen is shown, but with the audio setting grayed-out (there is no audio with DVI):

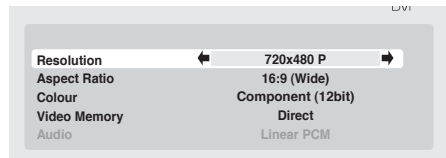

- Use the joystick (up/down) to select a setting.
- Use the joystick (left/right) to adjust the current setting.
- After you've finished, press **ENTER** to confirm any settings you've made and return to the Initial Settings menu.

You can adjust any or all of the following HDMI settings (the same options are available for DVI/HDCP-compatible devices):

Resolution

Since HDMI has the capacity to support many different high-definition video formats, you may want to change the resolution depending on the monitor you're using. The options that appear will depend on the video format of the current disc (NTSC or PAL).

- **VGA** – 640x480 pixel progressive-scan video (NTSC only)
- **720 x 480 P** (NTSC)/ **720 x 576 P** (PAL) – 720x480/576 pixel progressive-scan video
- **720 x 480 I** (NTSC)/ **720 x 576 I** (PAL) – 720x480/576 pixel interlace video
- **1280 x 720 P** – 1280x720 pixel progressive-scan video
- **1920 x 1080 I** – 1920x1080 pixel interlace video



Note

- When the resolution is changed, a confirmation message appears on the screen. Press **ENTER** to confirm. Note that this may take some time.
- If the screen goes blank after changing the resolution, it means the you selected a resolution incompatible with your monitor. Press and hold the (number) **0** button for 5 seconds to return to the auto resolution setting.

Aspect Ratio

Select an aspect ratio according to the kind of display you have, and how you want to see the image on-screen. Refer to the table below to match the HDMI resolution you chose in *Resolution* above to the disc type you're using and the setting on your monitor. See also *Screen sizes and disc formats* on page 81.

- **4:3 (Letter Box)** – Widescreen discs are shown with black bars top and bottom.

- **4:3 (Pan&Scan)** – Widescreen discs are shown with the left and right sides cropped.
- **16:9 (Wide)** – Use this setting if you have a widescreen monitor.
- **16:9(Compressed)** – Progressive-scan 4:3 material is shown with black bars on either side of the screen.

HDMI resolution setting	Disc type			
	Compressed		4:3	
	Aspect (HDMI)	Monitor setting	Aspect (HDMI)	Monitor setting
720 x 480 I/P (720 x 576 I/P)	16:9 (Wide)/ 16:9 (Com-pressed)	Full/ Squeeze	4:3/ 16:9 (Wide)	Normal/ Pass- thru/ Dot-by- dot/4:3
1280 x 720 P		Normal/ Pass- thru/ Dot-by- dot/4:3	16:9 (Com-pressed)	
1920 x 1080 I				



Note

- The monitor settings listed in the table may be different from your monitor's settings.

Colour

This setting determines the video output colour format. Depending on the connected equipment, some HDMI Colour settings may cause the picture to be displayed incorrectly. In this case, use the TV's own video input settings to select RGB, if possible. Alternatively, revert to the previous HDMI Colour setting.

- **Full Range RGB** – Gives brighter colours and deeper black. Use if colours are weak. (This is the standard setting for HDMI-compatible DVI devices, but it is also effective with HDMI devices.)

- **RGB** – Use this setting if colours appear overly rich on the **Full Range RGB** setting.
- **Component (12-bit)** – Outputs 12-bit component video format. If your connected device is compatible with this setting, 12-bit output provides very fine gradations of colour (if it is not compatible with this setting, the setting automatically reverts to **Component**).
- **Component** – Outputs 8-bit component video format. This is the standard setting for HDMI-compatible devices.

Video Memory

These settings allow you to change the appearance of the HDMI video presentation. You can also access these options from the Video Adjust menu (see *Video Adjust* on page 58 for more on this).

- **Direct** – The picture appears simply according to how the source was encoded.
- **Natural** – Edges are softer making this setting good for movies.
- **Enhanced** – Edges are sharper making this setting ideal for animation and material with computer generated effects.
- **Memory1-3** – Use for saving your own presets (see *Creating your own presets* on page 58 for more on this)

Audio

If the monitor or device you have connected using HDMI is not compatible with compressed multi-channel formats, you should set this to **Linear PCM**, otherwise set to **Auto**.

- **Linear PCM** – All audio signals are output as linear PCM.

- **Auto** – Dolby Digital, DTS and MPEG sources are processed according to how they were encoded, and linear PCM sources are heard with no processing.



Note

- Even with **Auto** selected, if the monitor or device you have connected using HDMI is not compatible with multi-channel formats, the audio signal will be output as linear PCM.
- It is not possible to output SACD from the HDMI connection.
- If necessary, sources with high sample rates (such as DVD-Audio 88.2/96/176.4/192 kHz sources) will be downsampled to match the sampling rate of your connected HDMI component.

CD Playback

- Default setting: **PCM Playback**

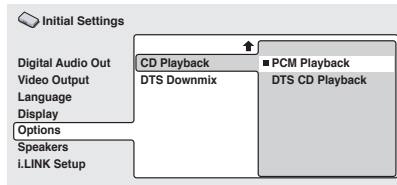

When set to **PCM Playback**, playback is optimized for standard audio CDs. You can also play DTS CDs, however you may notice some noise when a DTS CD starts playing. This is not a malfunction.

When set to **DTS CD Playback**, playback is optimized for DTS CDs. In this mode you cannot play standard audio CDs through the analog outputs. Change the setting back to **PCM Playback** to play standard CDs.

The i.LINK audio output is not affected by this setting.

DTS Downmix

- Default setting: **Stereo**

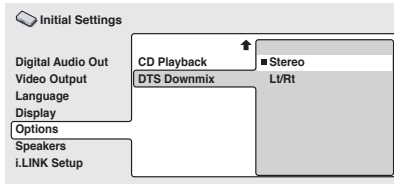

If you've selected **DTS > PCM** in *DTS Out* on page 62, or **2 Channel** in *Audio Output Mode* below, you can choose the way the DTS signal is downmixed PCM audio. **Stereo** downmixes the signal to 2-channel stereo, whereas **Lt/Rt** downmixes to a 2-channel signal compatible with Dolby surround matrix decoders. (This allows you to hear surround sound if your AV receiver or amplifier has Dolby Pro Logic capability.)

Note

If you've selected **DTS > PCM** in *DTS Out* on page 62 and **5.1 Channel** in *Audio Output Mode* below, the **DTS Downmix** setting will automatically be set to **Stereo**.

Speakers

Audio Output Mode

- Set in Setup Navigator (Default: **2 Channel**)

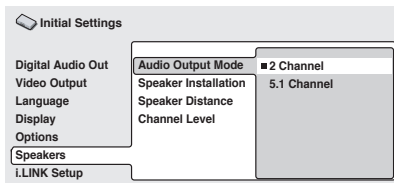

If you connected this player to an AV receiver using the 5.1 channel analog outputs, set this to **5.1 Channel**. This will enable you to enjoy multichannel sound.

If you connected only the stereo analog outputs, set to **2 Channel**. On this setting multichannel audio is downmixed to 2 channels for stereo analog output.

Note

- When set to **5.1 Channel**, you'll only get sound from all speakers when playing multichannel discs.
- When set to **5.1 Channel** the **AUDIO OUT (2ch)** jacks output the front L/R channels of multichannel discs.
- When set to **5.1 Channel** there is no optical/coaxial digital output when playing DVD-Audio discs.
- Some DVD-Audio discs don't allow downmixing of audio. These discs always output multi-channel audio regardless of the setting made here.

Speaker Installation

- Set in Setup Navigator (default: **L/R: Large | C: Large | LS/RS: Large | SW: On**)

You only need to make this setting if you connected this player to your amplifier using the 5.1 channel analog outputs.

This setting does not affect any digital audio output.

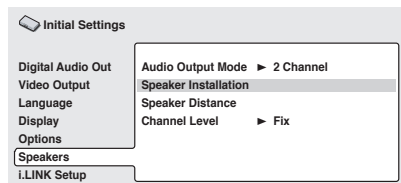

Use the **Speaker Installation** screen to tell the player what kinds of speakers you have connected.

1 Use the Joystick to move the cursor up/down to select a speaker.

- The **L** and **R**, and **RS** and **LS** speakers are paired; you can't set them differently.

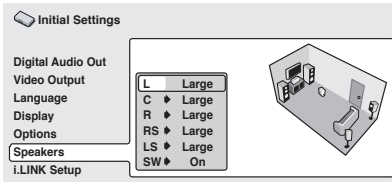

2 Move the cursor right to modify the selected speaker.

3 Use the Joystick (up/down) to change the current setting.

- You can see the effect of your changes in the room graphic on the right of the screen.
- Except for the subwoofer, you can set speaker size to **Large** or **Small**. If the main speaker cone in the speaker is 12cm or more, set to **Large**, otherwise set to **Small** (or **Off** if you don't have that speaker).
- If you set the front **L** and **R** speakers to **Small**, the center and surround speakers are automatically set to **Small** and the subwoofer to **On**.
- The subwoofer can only be set to **On** or **Off**.

4 Move the cursor left to go back to the speaker list if you want to modify another speaker, or press ENTER to exit the Speaker Installation screen.

Speaker Distance

- Default setting: all speakers **10ft.**

You only need to make this setting if you connected this player to your amplifier using the 5.1 channel analog outputs.

These settings do not affect any digital audio output.

To get the best surround sound from your system, you should set up the speaker distances from your listening position.

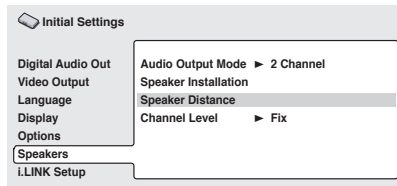

1 Use the Joystick to move the cursor up/down to select a speaker.

- The **L** and **R** speakers are paired; you can't set them differently.

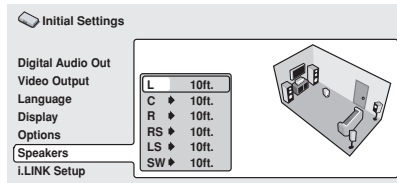

2 Move the cursor right to change the speaker distance for the highlighted speaker.

3 Use the Joystick (up/down) to change the distance.

- When you change the distance settings of the front left (**L**) or front right (**R**) speakers, all the other speaker distances change relative to it.
- Front left/right (**L/R**) speaker distances can be set from 1ft. to 30ft. in 0.5 ft. increments.

- The center speaker (**C**) and subwoofer (**SW**) can be set from -6.5 ft. to $+6.5$ ft. relative to the front left/right speakers.
- Surround left/right (**LS/RS**) speakers can be set from -20 ft. to $+6.5$ ft. relative to the front left/right speakers.

4 Move the cursor left to go back to the speaker list if you want to modify another speaker, or press ENTER to exit the Speaker Distance screen.



Note

- Speaker Distance settings do not affect SACD playback.

Channel Level

- Default setting: **Fix**

You only need to make this setting if you connected this player to your amplifier using the 5.1 channel analog outputs.

These settings do not affect any digital audio output.

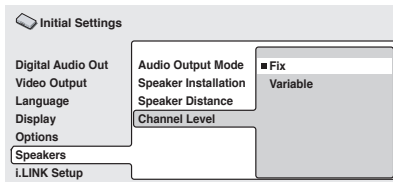

When set to **Fix**, the level of each of the 5.1 channel analog outputs is fixed. Choose **Variable** if you want to adjust the relative levels to balance the surround sound better for your listening room.

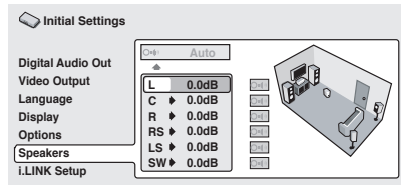

You can set the individual channel levels between -6 dB and $+6$ dB in 0.5 dB increments using the test tone output as a guide to set the correct levels. Adjust the levels until the output level from all channels sounds the same from your usual listening position. Note that **Audio Output Mode** (page 74) must be set to **5.1 Channel** in order to use the test tone.

Automatic: Select **Auto** to start the test tone output. No sound will be heard from the subwoofer.

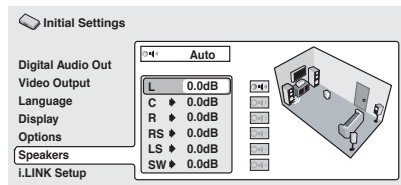

As the test tone plays through each speaker in turn, it is highlighted on-screen. Use the Joystick (up/down) to adjust the channel output level of the current speaker. Move the cursor left to exit the test tone sequence, or **ENTER** to save the settings and exit the channel level setting screen.

Manual: Use the Joystick to move the cursor up/down to select a speaker.

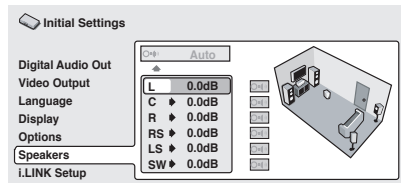

Move the cursor right (or press **ENTER**) then use the Joystick (up/down) to set the channel output level.

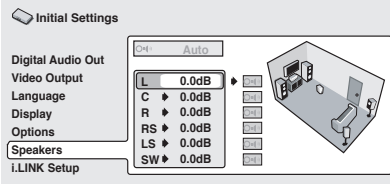

To turn the test tone on/off for an individual speaker, move the cursor right. The test tone continues playing even when you select a different speaker.

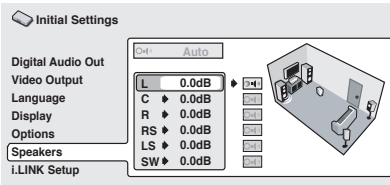

To save the settings and exit, press **ENTER** with the channel level field highlighted (as shown above).

Note

- The subwoofer output will sound quite low compared to the other speakers.

i.LINK Setup

Audio Out

- Default setting: **On**

You only need to make this setting if you connected this player to other equipment using the i.LINK interface.

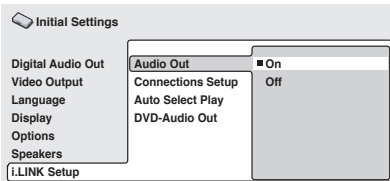

Change this setting to **Off** if the i.LINK interface is still connected but you need to use one of the other outputs. Changing this setting to **Off** does not affect i.LINK thru data (i.e., if this player is between two other i.LINK components, it will still pass data between them).

Set back to **On** (i.LINK-ready) to be able to use the i.LINK interface.

Connections Setup

You only need to make this setting if you connected this player to other equipment using the i.LINK interface.

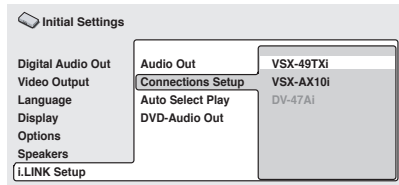

This screen shows the equipment connected using the i.LINK interface.

Components which are able to receive i.LINK Audio are shown in black (an i.LINK receiver, for example); those which can't (a DV camcorder, for example) are shown in gray. If the player can't display the name of a component, '****' is shown; if the name can't be determined, Unknown is displayed.

Select the component that you want to set up the audio output formats for.

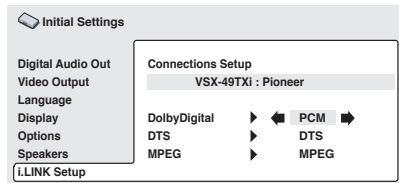

This screen shows the output settings for Dolby Digital, DTS and MPEG audio. Depending on the other component, these may be configured automatically. If this

player can't determine the appropriate settings, the defaults are **Dolby Digital**, **DTS** and **PCM**. If you need to change the settings, move the cursor right and make the new setting.

Auto Select Play

- Default setting: **Off**

You only need to make this setting if you connected this player to other equipment using the i.LINK interface.

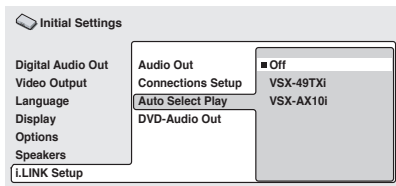

Using this setting you can specify up to five receivers to automatically switch input function to this player when you start playback of a disc. Highlight a receiver from the list and press **ENTER**.

The most recently selected component is marked with an orange box (■). The i.LINK output when playing Dolby Digital, DTS or MPEG discs will be as set for this component (see also Connections Setup above).

Select **Off** to reset all the settings.

When the i.LINK connections are changed, the following screen appears.

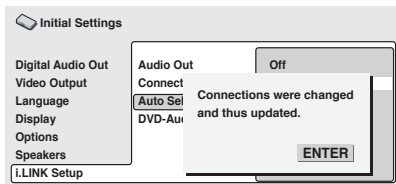

Press **ENTER** to return to the menu screen.



Note

- Whether a receiver from the list has been selected or not, this player will start playback when you change the input function of the receiver to this player.
- Note that some AV receivers may not be compatible with this feature.

DVD-Audio Out

- Default setting: **5.1 Channel**

You only need to make this setting if you connected this player to other equipment using the i.LINK interface.

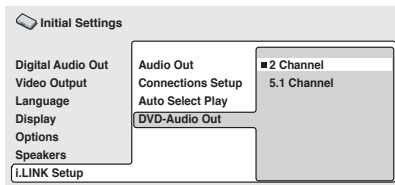

Set this to **5.1 Channel** to enjoy surround sound when playing multichannel discs.

To downmix a multichannel source when using the i.LINK connection, set to **2 Channel** for stereo output.



Note

- When set to **5.1 Channel**, you'll only get sound from all speakers when playing multichannel discs.
- Some DVD-Audio discs don't allow downmixing of audio. These discs always output multi-channel audio regardless of the setting made here.

Chapter 9

Additional information

Taking care of your player and discs

Handling discs

When holding discs of any type, take care not to leave fingerprints, dirt or scratches on the disc surface. Hold the disc by its edge or by the center hole and edge.

Damaged or dirty discs can affect playback performance. Take care also not to scratch the label side of the disc. Although not as fragile as the recorded side, scratches can still result in a disc becoming unusable.

Should a disc become marked with fingerprints, dust, etc., clean using a soft, dry cloth, wiping the disc lightly from the center to the outside edge as shown in the diagram below.

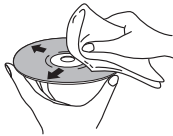

Wipe lightly from the center of the disc using straight strokes.



Don't wipe the disc surface using circular strokes.

If necessary, use a cloth soaked in alcohol, or a commercially available CD/DVD cleaning kit to clean a disc more thoroughly. Never use benzine, thinner or other cleaning agents, including products designed for cleaning vinyl records.

Storing discs

Although CDs and DVD discs are more durable than vinyl records, you should still take care to handle and store discs correctly. When you're not using a disc, return it to its case and store upright. Avoid leaving discs in excessively cold, humid, or hot environments (including under direct sunlight).

Don't glue paper or put stickers onto the disc, or use a pencil, ball-point pen or other sharp-tipped writing instrument. These could all damage the disc.



For more detailed care information see the instructions that come with discs.

Do not load more than one disc into the player at a time.

Discs to avoid

Discs spin at high speed inside the player. If you can see that a disc is cracked, chipped, warped, or otherwise damaged, don't risk using it in your player—you could end up damaging it.

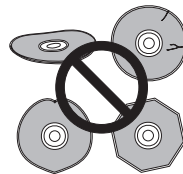

This player is designed for use with conventional, fully circular discs only. Use of shaped discs is not recommended for this product. Pioneer disclaims all liability arising in connection with the use of shaped discs.

Cleaning the pickup lens

The DVD player's lens should not become dirty in normal use, but if for some reason it should malfunction due to dust or dirt, consult your nearest Pioneer-authorized service center. Although lens cleaners for CD players are commercially available, we do not recommend using them since some may damage the lens.

Problems with condensation

Condensation may form inside the player if it is brought into a warm room from outside, or if the temperature of the room rises quickly. Although the condensation won't damage the player, it may temporarily impair its performance. For this reason you should leave it to adjust to the warmer temperature for about an hour before switching on and using.

Hints on installation

We want you to enjoy using this product for years to come, so please bear in mind the following points when choosing a suitable location for it:

Do...

- Use in a well-ventilated room.
- Place on a solid, flat, level surface, such as a table, shelf or stereo rack.

Don't...

- Use in a place exposed to high temperatures or humidity, including near radiators and other heat-generating appliances.

- Place on a window sill or other place where the player will be exposed to direct sunlight.
- Use in an excessively dusty or damp environment.
- Place directly on top of an amplifier, or other component in your stereo system that becomes hot in use.
- Use near a television or monitor as you may experience interference—especially if the television uses an indoor antenna.
- Use in a kitchen or other room where the player may be exposed to smoke or steam.
- Use on a thick rug or carpet, or cover with cloth—this may prevent proper cooling of the unit.
- Place on an unstable surface, or one that is not large enough to support all four of the unit's feet.

Moving the player

If you need to move the player, first press **POWER** on the front panel to turn the player off. Wait for **--OFF--** to disappear from the display, then unplug the power cable.

Never lift or move the unit during playback—discs rotate at a high speed and may be damaged.

Power cable caution

Handle the power cable by the plug part. Do not pull out the plug by tugging the cable, and never touch the power cable when your hands are wet, as this could cause a short circuit or electric shock. Do not place the unit, a piece of furniture, or other object on the power cable or pinch the cable in any other way. Never make a knot in the cable or tie it with other cables. The power cables should be routed so that they are not likely to be stepped on. A damaged power cable can cause a fire

or give you an electric shock. Check the power cable once in a while. If you find it damaged, ask your nearest Pioneer authorized service center or your dealer for a replacement.

Screen sizes and disc formats

DVD-Video discs come in several different screen aspect ratios, ranging from TV programs, which are generally 4:3, to Cinema-Scope widescreen movies, with an aspect ratio of up to about 7:3.

Televisions, too, come in different aspect ratios; 'standard' 4:3 and widescreen 16:9.

Widescreen TV users

If you have a widescreen TV, the **TV Screen** setting (page 63) of this player should be set to **16:9 (Wide)**.

When you watch discs recorded in 4:3 format, you can use the TV controls to select how the picture is presented. Your TV may offer various zoom and stretch options; see the instructions that came with your TV for details.

Please note that some movie aspect ratios are wider than 16:9, so even though you have a widescreen TV, these discs will still play in a 'letter box' style with black bars at the top and bottom of the screen.

Standard TV users

If you have a standard TV, the **TV Screen** setting (page 63) of this player should be set to **4:3 (Letter Box)** or **4:3 (Pan&Scan)**, depending on which you prefer.

Set to **4:3 (Letter Box)**, widescreen discs are shown with black bars top and bottom.



Set to **4:3 (Pan&Scan)**, widescreen discs are shown with the left and right sides cropped. Although the picture looks larger, you don't actually see the whole picture.



Please note that many widescreen discs override the player's settings so that the disc is shown in letter box format regardless of the setting.



Note

- Using the **16:9 (Wide)** setting with a standard 4:3 TV, or either of the **4:3** settings with a widescreen TV, will result in a distorted picture.

Resetting the player

Use this procedure to reset all the player's settings to the factory default.

1 Switch the player into standby.

2 Using the front panel buttons, hold down the ■ (stop) button and press POWER to switch the player back on.

All the player's settings are now reset, and you should see the 'Let's Get Started' screen.

About the audio output settings

The table below shows how the audio settings you make in the **Digital Audio Out** and **Audio Output Mode** screens (see *Digital Audio Out settings* on page 61 and *Audio Output Mode* on page 74) affect the output from the 2 channel and the 5.1 channel analog outputs, and from the optical/coaxial digital outputs with various types of disc.

Disc audio format	Player setting	Front L/R analog outputs* ¹	Surround L/R Center, LFE, outputs* ¹	Digital outputs PCM convert* ²	Bitstream* ³	
DVD	Dolby Digital	2 Ch	2ch downmix	–	2ch downmix	Dolby Digital
		5.1 Ch	Front L / R	Surround L/R, Center, LFE		
	Dolby Digital karaoke	2 Ch / 5.1 Ch	Left / Right	–	Left / Right	Dolby Digital
	Linear PCM	2 Ch / 5.1 Ch	Left / Right	–	Left / Right	Left / Right
	DTS	2 Ch	2ch downmix	–	2ch downmix	DTS
		5.1 Ch	Front L / R	Surround L/R, Center, LFE		
	MPEG	2 Ch / 5.1 Ch	Left / Right	–	Left / Right	MPEG
DVD-Audio	2 Ch	2ch downmix* ⁴	–	2ch downmix* ⁵	2ch downmix* ⁵	
	5.1 Ch	Front L / R	Surround L/R, Center, LFE	–	–	
DVD-RW	2 Ch / 5.1 Ch	Left / Right* ⁶	–	Left / Right	Dolby Digital MPEG or PCM	
Super Audio CD	2 Ch	2ch downmix	–	–	–	
	5.1 Ch	Front L / R	Surround L/R, Center, LFE			
CD	2 Ch / 5.1 Ch	Left / Right	–	Left / Right	Left / Right	
DTS CD	2 Ch	2ch downmix	–	DTS	DTS	
	5.1 Ch	Front L / R	Surround L/R, Center, LFE			
Video CD	2 Ch / 5.1 Ch	Left / Right	–	Left / Right	Left / Right	

*¹ When **Audio Output Mode** is set to **2 Channel**, the **AUDIO OUT (5.1ch) FRONT L / R** jacks act as a second pair of stereo audio outputs.

*² **Dolby Digital > PCM**, **MPEG > PCM** or **DTS > PCM** setting (see *Digital Audio Out settings* on page 61)

*³ **Dolby Digital**, **MPEG** or **DTS** setting (see *Digital Audio Out settings* on page 61)

*⁴ Discs that prohibit downmixing will be output as 5.1 channel even if **2 Channel** is selected as the **Audio Output Mode** setting (see *Audio Output Mode* on page 74)

*⁵ Discs that prohibit downmixing also mute the digital output

*⁶ If the sound is mono, the **Left** and **Right** channels will be the same

About the HDMI output settings

The table below shows how the audio settings you make in the **HDMI** and **Audio Output Mode** screens (see *HDMI Settings* on page 71 and *Audio Output Mode* on page 74) affect the HDMI output with various types of disc.

Disc audio format		HDMI Audio Setting	
		Linear PCM	Auto
DVD	Dolby Digital* ¹	2 ch downmix	Dolby Digital* ²
	Dolby Digital (Karaoke)	Left / Right	Dolby Digital* ²
	Linear PCM* ¹	Left / Right	Left / Right
	DTS	2 ch downmix	DTS* ²
	MPEG* ¹	Left / Right	MPEG* ²
	DVD-Audio (with CPPM)	5.1 ch* ³	
	DVD-Audio (without CPPM)	5.1 ch	
	CD / MP3	Left / Right	
	DTS CD	DTS	
	Video CD	Left / Right	
		SACD Playback	
		2 ch Area	Multi-ch Area
Super Audio CD	— * ⁴	— * ⁴	Left / Right* ⁵

*¹ These formats include DVD-RW discs.

*² If the HDMI device you are using is not compatible with these compressed formats, the signal is output as linear PCM.

*³ If the connected component is not DVD-Audio (CPPM) compatible, it is not possible to output CPPM copy-controlled DVD-Audio sources from the HDMI connection (see *HDMI output with DVD-Audio sources* below for more on this).

*⁴ It is not possible to listen to SACDs using the HDMI connection.

*⁵ Only applicable to discs that have a CD area.

HDMI output with DVD-Audio sources

DVD-Audio sources often have high sample rates (such as 192kHz/24bit/2 channel or 96kHz/24bit/6 channel) and the way they are output from the HDMI terminal will depend on the specification of the connected component.

Component specification		Example Component	Format		Speakers Audio Output Mode (p.74)
			2 ch	5.1 ch	
Component/output	HDMI Ver. 1.1 (DVD-Audio and 5.1 channel compatible)* ¹	VSX-74TXVi VSX-72TXV	2 ch	5.1 ch* ² * ³	Set to '5.1 Channel'
	HDMI Ver. 1.1 (DVD-Audio and 2 channel compatible)* ¹	PRO-1130HD PDP-5060HD	2 ch	Left/Right or 2 ch downmix* ⁴	Set to '2 Channel'
	HDMI Ver. 1.1 (Incompatible with DVD-Audio) or only HDMI Ver. 1.0* ¹	PRO-1120HD PDP-5045HD/5050HD	No sound* ⁴	No sound* ⁵	

*¹ This unit checks the specification of the connected component (such sample rate / multi-channel limitations and CPPM compatibility) and outputs the signal accordingly. Note that 'DVD-Audio compatible' indicates compatibility with CPPM (Content Protection for Pre-recorded Media).

*² If the Speakers **Audio Output Mode** (page 74) is set to **2 channel**, multichannel sources will be downmixed to stereo. (In cases where the source is downmix-prohibited, it is output as 5.1 channel audio.)

*³ If the video output resolution is VGA, 480i, 576i, 480p or 576p, audio output may be limited to 2 channel (depending to the connected component).

*⁴ If the Speakers **Audio Output Mode** (page 74) is set to **2 channel**, multichannel sources will be downmixed to stereo. (In cases where the source is downmix-prohibited, only the front left/right channels are output.)

*⁵ If **CPPM** shows in the front panel display, it means it is not possible to output CPPM copy-controlled DVD-Audio sources from the HDMI connection. Discs with no CPPM protection are limited to 2 channel output.

About the i.LINK output settings

The table below shows how the audio settings you make in the **SACD Playback**, **DVD-Audio Out** and **Connections Setup** screens (see *SACD Playback* on page 71, *DVD-Audio Out* on page 78 and *Connections Setup* on page 77) affect the i.LINK audio output with various types of disc.

Disc audio format		Connections Setup	
		Bitstream* ¹	Bitstream > PCM* ²
DVD	Dolby Digital	Dolby Digital	2 ch downmix
	Dolby Digital (Karaoke)	Dolby Digital	Left / Right
	Linear PCM	Left / Right	Left / Right
	DTS	DTS	2 ch downmix
	MPEG	MPEG	Left / Right
	DVD-RW (mono, dual mono, 2ch)	Left / Right	Left / Right
	DVD-RW (3ch or more)	Dolby Digital / MPEG	Left / Right
		DVD-Audio Out	
	2 Channel	5.1 Channel	
	DVD-Audio	2 ch downmix	Multi-channel
CD / MP3		Left / Right	
DTS CD		DTS	
Video CD		Left / Right	
	SACD Playback		
	2 ch Area	Multi-ch Area	CD Area
Super Audio CD	Left / Right	Multi-channel* ³	Left / Right* ⁴

*¹ Dolby Digital, DTS or MPEG setting (see *Connections Setup* on page 77)

*² PCM setting (see *Connections Setup* on page 77)

*³ Only applicable to discs that have a multichannel area.

*⁴ Only applicable to discs that have a CD area.

Language code list

Language (Language code letter), **Language code**

Japanese (ja), 1001	Estonian (et), 0520	Lingala (ln), 1214	Slovak (sk), 1911
English (en), 0514	Basque (eu), 0521	Laothian (lo), 1215	Slovenian (sl), 1912
French (fr), 0618	Persian (fa), 0601	Lithuanian (lt), 1220	Samoan (sm), 1913
German (de), 0405	Finnish (fi), 0609	Latvian (lv), 1222	Shona (sn), 1914
Italian (it), 0920	Fiji (fj), 0610	Malagasy (mg), 1307	Somali (so), 1915
Spanish (es), 0519	Faroeese (fo), 0615	Maori (mi), 1309	Albanian (sq), 1917
Dutch (nl), 1412	Frisian (fy), 0625	Macedonian (mk), 1311	Serbian (sr), 1918
Russian (ru), 1821	Irish (ga), 0701	Malayalam (ml), 1312	Siswati (ss), 1919
Chinese (zh), 2608	Scots-Gaelic (gd), 0704	Mongolian (mn), 1314	Sesotho (st), 1920
Korean (ko), 1115	Galician (gl), 0712	Moldavian (mo), 1315	Sundanese (su), 1921
Greek (el), 0512	Guarani (gn), 0714	Marathi (mr), 1318	Swedish (sv), 1922
Afar (aa), 0101	Gujarati (gu), 0721	Malay (ms), 1319	Swahili (sw), 1923
Abkhazian (ab), 0102	Hausa (ha), 0801	Maltese (mt), 1320	Tamil (ta), 2001
Afrikaans (af), 0106	Hindi (hi), 0809	Burmese (my), 1325	Telugu (te), 2005
Amharic (am), 0113	Croatian (hr), 0818	Nauru (na), 1401	Tajik (tg), 2007
Arabic (ar), 0118	Hungarian (hu), 0821	Nepali (ne), 1405	Thai (th), 2008
Assamese (as), 0119	Armenian (hy), 0825	Norwegian (no), 1415	Tigrinya (ti), 2009
Aymara (ay), 0125	Interlingua (ia), 0901	Occitan (oc), 1503	Turkmen (tk), 2011
Azerbaijani (az), 0126	Interlingue (ie), 0905	Oromo (om), 1513	Tagalog (tl), 2012
Bashkir (ba), 0201	Inupiak (ik), 0911	Oriya (or), 1518	Setswana (tn), 2014
Byelorussian (be), 0205	Indonesian (in), 0914	Panjabi (pa), 1601	Tonga (to), 2015
Bulgarian (bg), 0207	Icelandic (is), 0919	Polish (pl), 1612	Turkish (tr), 2018
Bihari (bh), 0208	Hebrew (iw), 0923	Pashto, Pushto (ps), 1619	Tsonga (ts), 2019
Bislama (bi), 0209	Yiddish (ji), 1009	Portuguese (pt), 1620	Tatar (tt), 2020
Bengali (bn), 0214	Javanese (jw), 1023	Quechua (qu), 1721	Twi (tw), 2023
Tibetan (bo), 0215	Georgian (ka), 1101	Rhaeto-Romance (rm), 1813	Ukrainian (uk), 2111
Breton (br), 0218	Kazakh (kk), 1111	Kirundi (rn), 1814	Urdu (ur), 2118
Catalan (ca), 0301	Greenlandic (kl), 1112	Romanian (ro), 1815	Uzbek (uz), 2126
Corsican (co), 0315	Cambodian (km), 1113	Kinyarwanda (rw), 1823	Vietnamese (vi), 2209
Czech (cs), 0319	Kannada (kn), 1114	Sanskrit (sa), 1901	Volapük (vo), 2215
Welsh (cy), 0325	Kashmiri (ks), 1119	Sindhi (sd), 1904	Wolof (wo), 2315
Danish (da), 0401	Kurdish (ku), 1121	Sangho (sg), 1907	Xhosa (xh), 2408
Bhutani (dz), 0426	Kirghiz (ky), 1125	Serbo-Croatian (sh), 1908	Yoruba (yo), 2515
Esperanto (eo), 0515	Latin (la), 1201	Sinhalese (si), 1909	Zulu (zu), 2621

Country/Area code list

Country/Area, Country/Area code, **Country/Area code letter**

Argentina, 0118, ar	Hong Kong, 0811, hk	Philippines, 1608, ph
Australia, 0121, au	India, 0914, in	Portugal, 1620, pt
Austria, 0120, at	Indonesia, 0904, id	Russian Federation, 1821, ru
Belgium, 0205, be	Italy, 0920, it	Singapore, 1907, sg
Brazil, 0218, br	Japan, 1016, jp	Spain, 0519, es
Canada, 0301, ca	Korea, Republic of, 1118, kr	Switzerland, 0308, ch
Chile, 0312, cl	Malaysia, 1325, my	Sweden, 1905, se
China, 0314, cn	Mexico, 1324, mx	Taiwan, 2023, tw
Denmark, 0411, dk	Netherlands, 1412, nl	Thailand, 2008, th
Finland, 0609, fi	New Zealand, 1426, nz	United Kingdom, 0702, gb
France, 0618, fr	Norway, 1415, no	United States of America, 2119, us
Germany, 0405, de	Pakistan, 1611, pk	

Selecting languages using the language code list

Some of the language options (such as 'DVD Language' in the Setup Navigator) allow you to set your preferred language from any of the 136 languages listed in the language code list on page 86.

- 1 **Select 'Other Language'.**
- 2 **Use the Joystick (left/right) to select either a code letter or a code number.**
- 3 **Use the Joystick (up/down) to select a code letter or a code number.**

- You can also use the number buttons if you're entering a language code.

See *Language code list* on page 86 for a complete list of languages and codes.

Glossary

Analog audio

An electrical signal that directly represents sound. Compare this to digital audio which can be an electrical signal, but is an indirect representation of sound. See also *Digital audio*.

Aspect ratio

The width of a TV screen relative to its height. Conventional TVs are 4:3 (in other words, the screen is almost square); widescreen models are 16:9 (the screen is almost twice as wide as it is high).

Bonus Group (DVD-Audio only)

An 'extra' group on some DVD-Audio discs that requires a key number to access.

Browsable pictures (DVD-Audio only)

A feature of some DVD-Audio discs in which the user can browse still pictures recorded on the disc as the audio is played. See also *Slide-show*.

Digital audio

An indirect representation of sound by numbers. During recording, the sound is measured at discrete intervals (44,100 times a second for CD audio) by an analog-to-digital converter, generating a stream of numbers. On playback, a digital-to-analog converter generates an analog signal based on these numbers. See also *Sampling frequency* and *Analog audio*.

Dolby Digital



Using a maximum of 5.1 channels of audio, this high quality surround system is used in many of the finer movie theaters around the world.

The on-screen display shows which channels are active, for example showing 3/2.1. The 3 being the two front channels and the center channel; the 2 being the surround channels, and the .1 being the LFE channel.

DTS



DTS stands for Digital Theater Systems. DTS is a surround system different from Dolby Digital that has become a popular surround sound format for movies.

Dynamic range

The difference between the quietest and loudest sounds possible in an audio signal (without distorting or getting lost in noise). Dolby Digital and DTS soundtracks are capable of a very wide dynamic range, delivering dramatic cinema-like effects.

File extension

A tag added to the end of a filename to indicate the type of file. For example, “.mp3” indicates an MP3 file.

i.LINK

i.LINK is a trademark name of IEEE1394, a high-speed digital interface capable of carrying audio, video and other types of data (this player only outputs audio).

HDMI

HDMI (High-Definition Multimedia Interface) is a high-speed digital interface which has the capability to support standard, enhanced, or high-definition video plus standard to multi-channel surround-sound audio on a single digital connection. HDMI features include uncompressed digital video, a bandwidth of up to 5 gigabytes per second and communication between the AV source and AV devices such as DTVs.

HDMI, the HDMI logo and High-Definition Multimedia Interface are trademarks or registered trademarks of HDMI licensing LLC.

Interlaced video

A method of displaying a picture in which odd-numbered lines are updated in one pass, then even-numbered lines updated in the next. See also *Progressive scan video*.

ISO 9660 format

International standard for the volume and file structure of CD-ROM discs.

MP3

MP3 (MPEG1 audio layer 3) is a compressed audio file format. Files are recognized by their file extension “.mp3” or “.MP3”.

MPEG audio

An audio format used on Video CDs and some DVD discs. This unit can convert MPEG audio to PCM format for wider compatibility with digital recorders and AV amplifiers. See also *PCM (Pulse Code Modulation)*.

MPEG video

The video format used for Video CD/s and DVDs. Video CD uses the older MPEG-1 standard, while DVD uses the newer and much better quality MPEG-2 standard.

Packed PCM (DVD-Audio only)

A lossless compression system that enables more PCM audio to be stored on a DVD-Audio disc than would otherwise be possible.

PBC (PlayBack Control) (Video CD/ only)

A system of navigating a Video CD through on-screen menus recorded onto the disc. Especially good for discs that you would normally not watch from beginning to end all at once—karaoke discs, for example.

PCM (Pulse Code Modulation)

The most common system of encoding digital audio, found on CDs and DAT. Excellent quality, but requires a lot of data compared to formats such as Dolby Digital and MPEG audio. For compatibility with digital audio recorders (CD, MD and DAT) and AV amplifiers with digital inputs, this unit can convert Dolby Digital, DTS and MPEG audio to PCM. See also *Digital audio*.

**PQLS (Precision Quartz Lock System)
[rate control]**

Technology for high-precision transmission of digital audio over the i.LINK interface enabling jitterless digital-to-analog conversion using a precision quartz in the rate control-compatible receiver.

Progressive scan video

Also called non-interlaced video, this method of displaying a picture updates all the lines in one pass, resulting in a more stable, flicker-free image than interlaced video (for a given scanning rate). See also Interlaced video. See also *About progressive scan video* on page 26.

Regions (DVD-Video only)

These associate discs and players with particular areas of the world. This unit will only play discs that have compatible region codes. You can find the region code of your unit by looking on the rear panel. Some discs are compatible with more than one region (or all regions).

S1 S-video output

This S-video signal format includes aspect ratio information (4:3 or 16:9) within the video signal. TVs which are compatible with S1 S-video automatically switch aspect ratio according to the signal.

S2 S-video output

S2 is an enhanced version of S-video which, in addition to aspect ratio information, contains letterbox / pan & scan information. Wide-screen TVs which are compatible with S2 S-video automatically switch aspect ratio according to the signal.

Sampling frequency

The rate at which sound is measured to be turned into digital audio data. The higher the rate, the better the sound quality, but the more digital information is generated. Standard CD audio has a sampling frequency of 44.1kHz, which means 44,100 samples (measurements) per second. See also *Digital audio*.

Slideshow (DVD, Video CD/)

A feature of some DVD discs in which still pictures recorded on the disc cycle automatically as the audio is played. See also *Browsable Picture*.

Super Audio CD (SACD)

Super Audio CD is a high quality audio disc format that can accommodate high sampling rate stereo and multi-channel audio, as well as conventional CD audio all on the same disc.

Troubleshooting

Incorrect operation is often mistaken for trouble or malfunction. If you think that there is something wrong with this component, check the points below. Sometimes the trouble may lie in another component. Inspect the other components and electrical appliances being used. If the trouble cannot be rectified after checking the items below, ask your nearest Pioneer authorized service center or your dealer to carry out repair work.

General

Problem	Remedy
The disc won't play or is automatically ejected after loading.	<ul style="list-style-type: none"> • Make sure the disc is free from dirt and dust and is not damaged (see <i>Taking care of your player and discs</i> on page 79). • Make sure the disc is loaded with the label side face-up and aligned properly in the disc tray guide. • Incompatible region number: If the region number on a DVD-Video disc does not match the number on the player, the disc cannot be used (see <i>DVD-Video regions</i> on page 13). • Condensation inside the player: Allow time for condensation to evaporate. Avoid using the player near an air-conditioning unit.
DVD-Audio playback stops.	<ul style="list-style-type: none"> • The disc may have been illegally copied.
Picture playback stops and the operation buttons cannot be used.	<ul style="list-style-type: none"> • Press ■, then start playback again (▶). • Switch the power off once, unplug from the wall socket, then plug back in and switch on again by pressing ⏻ STANDBY/ON to switch the player on.
New settings made in the Setup screen menus while a disc is playing are ineffective.	<ul style="list-style-type: none"> • Some settings can be changed while a disc is playing, but are not effective until the disc is stopped then restarted: Press ■, then start playback again (▶).
Settings are canceled.	<ul style="list-style-type: none"> • When the power is cut due to power failure or by unplugging the power cord during operation, settings will be canceled. See <i>Moving the player</i> on page 80 for proper shutdown instructions.

DVD/CD/Video CD/ player

Problem	Remedy
The remote control doesn't seem to work.	<ul style="list-style-type: none"> • The CONTROL IN jack on the rear panel is connected: Point the remote control at the connected component to control this player. • The remote control is too far from the player, or the angle with the remote sensor is too wide: Use the remote within its operating range (see <i>Using the remote control</i> on page 10). • The batteries are exhausted: Put in new ones (see <i>Putting the batteries in the remote control</i> on page 10).
No picture/No color.	<ul style="list-style-type: none"> • Check that the PURE AUDIO indicator is not lit. If it is, press the PURE AUDIO button (See also <i>Front panel</i> on page 25). • Incorrect video connections: Check that connections are correct and that plugs are inserted fully. Also check the video cable for damage. • TV/monitor or AV amplifier settings are incorrect: Check the instruction manual of the connected equipment. • The video output is set to progressive but your TV/monitor is not compatible with progressive scan: Press the PROGRESSIVE button on the front panel to set to interlace (the indicator above the button should not be lit) (see <i>About progressive scan video</i> on page 26).
Screen is stretched or aspect does not change.	<ul style="list-style-type: none"> • The TV Screen setting in the Initial Settings menu is incorrect. See <i>TV Screen</i> on page 63 for how to set it correctly for your TV/monitor. • If your TV/monitor is connected using an S-video cable, try changing the S-Video Out setting (see <i>S-Video Out</i> on page 64).
Picture disturbance during playback or dark.	<ul style="list-style-type: none"> • This player is compatible with Macro-Vision System copy guard. Some discs include a copy prevention signal, and when this type of disc is played back, stripes etc., may appear on some sections of the picture depending on the TV. This is not a malfunction. • Due to the player's copy protection circuits, connection of this device through a VCR or an AV selector may prevent recording or cause picture problems. This is not a malfunction.

Problem	Remedy
No audio, or audio is distorted.	<ul style="list-style-type: none"> • No audio is output during slow motion playback or when scanning discs other than audio CDs • Some DVD discs do not output digital audio: Switch your amplifier to the player's analog outputs. • Check that the disc is free from dust and dirt, and that it is not damaged (<i>Taking care of your player and discs</i> on page 79). • Check that all interconnects are firmly inserted. • Check that the plugs and terminals are free of dirt, oxide, etc. and clean if necessary. Also check the cable for damage. • Make sure the player's output is not connected to the amplifier's phono (turntable) inputs. • Check your amplifier/receiver's settings (volume, input function, speaker settings, etc.).
The analog audio is OK, but there appears to be no optical/coaxial digital audio signal.	<ul style="list-style-type: none"> • Make sure that the Digital Out setting is set to On (see <i>Digital Out</i> on page 61). • Check that the Dolby Digital, DTS and MPEG Out settings (see <i>Digital Audio Out settings</i> on page 61) are suitable for your amplifier/receiver—check the instruction manual that came with your amplifier/receiver. • SACDs and some DVD-Audio discs do not output digital audio. Listen through the player's analog audio outputs. • Check that the PURE AUDIO indicator is not lit. If it is, press the PURE AUDIO button (See also <i>Front panel</i> on page 25).
Noticeable difference in DVD and CD volume.	<ul style="list-style-type: none"> • This is due to differences in the audio format and is not a malfunction.
Cannot play multi-channel audio.	<ul style="list-style-type: none"> • Make sure that Audio Output Mode is set to 5.1 Channel (see <i>Audio Output Mode</i> on page 74). • Check that the Dolby Digital, DTS and MPEG Out settings (see <i>Digital Audio Out settings</i> on page 61) are suitable for your amplifier/receiver—check the instruction manual that came with your amplifier/receiver. • DVD-Audio and SACDs do not output multichannel digital audio. Listen through the player's analog outputs. • Check that the settings in the <i>Speaker Installation</i> on page 74 are correct. • Check the audio options available from the disc menu.
Cannot listen to high-sampling rate audio through the optical/coaxial digital output.	<ul style="list-style-type: none"> • Make sure that Linear PCM Out is set to Down Sample Off (see <i>Linear PCM Out</i> on page 62). • As a copy-protection measure, some DVDs do not output 96kHz audio. In this case, even if set to Down Sample Off, the player automatically outputs the audio at 48 kHz. This is not a malfunction.

Problem	Remedy
Cannot output 192kHz or 176.4kHz digital audio from optical/coaxial output.	<ul style="list-style-type: none"> The player does not output digital audio from the optical/coaxial jacks at these sampling rates. The digital output is automatically downsampled.
Cannot output 96kHz or 88.2kHz digital audio from optical/coaxial output.	<ul style="list-style-type: none"> Check that Linear PCM Out is set to Down Sample Off (see <i>Linear PCM Out</i> on page 62). Some discs are digital copy protected and do not output high sampling rate digital audio. In this case the output is automatically downsampled.
No DTS audio output from optical/coaxial output.	<ul style="list-style-type: none"> If this unit is connected to a non-DTS compatible amplifier or decoder using a digital audio cable, set DTS Out to DTS > PCM. If you do not do this, noise will be output when you play a DTS disc. If this unit is connected to a DTS-compatible amplifier or decoder using a digital audio cable, check the amplifier settings, and that the cable is properly connected.
Audio mix does not sound right or sounds incomplete (for example, inaudible dialog).	<ul style="list-style-type: none"> Make sure that Audio Output Mode is set to 2 Channel if you've connected to the stereo inputs on your amplifier or TV (see <i>Audio Output Mode</i> on page 74).
Disc containing the MP3 tracks won't play.	<ul style="list-style-type: none"> This player is compatible with multi-session discs, but only plays sessions that are closed. If the message UNPLAYABLE is displayed when you try to play a disc/track, check the audio file formats (<i>Compressed Audio Compatibility</i> on page 12).
Can't hear effect of TruSurround	<ul style="list-style-type: none"> TruSurround does not work with CD, MP3, DVD-Audio, SACD or 96kHz linear PCM DVD. The TruSurround effect is only output through the AUDIO OUT (2ch) analog audio outputs. Make sure that Audio Output Mode is set to 2 Channel (see <i>Audio Output Mode</i> on page 74). The effectiveness of TruSurround varies with the disc.

HDMI troubleshooting

Problem	Remedy
No HDMI audio output.	<ul style="list-style-type: none"> • This unit has been designed to be compliant with HDMI (High Definition Multimedia Interface) Version 1.1. Depending on the component you have connected, unreliable signal transfers may result. • If the front panel HDMI indicator is lit: <ul style="list-style-type: none"> – You won't hear any sound from the HDMI output if the source component is only DVI/HDCP-compatible. – It is not possible to output SACD sources from the HDMI connection. • If the front panel HDMI indicator is unlit then: <ul style="list-style-type: none"> – Make sure that you've selected this player as the HDMI input in the settings for the component you're using. You may need to refer to the instruction manual of the component to do this. – Check that the HDMI cable is connected properly and that the cable isn't damaged. – Check that components connected using the HDMI interface are switched on and HDMI compatible. (An HDMI connection can only be made with components compatible with both DVI and High Bandwidth Digital Content Protection (HDCP).) – Check that the PURE AUDIO indicator is not lit. If it is, press the PURE AUDIO button (See also <i>Front panel</i> on page 25).

Problem	Remedy
No HDMI video output	<ul style="list-style-type: none"> • Make sure that you've selected this player as the HDMI input in the settings for the component you're using. You may need to refer to the instruction manual of the component to do this. • It is not possible to output SACD sources from the HDMI connection. • Check that the HDMI cable is connected properly and that the cable isn't damaged. • Check that components connected using the HDMI interface are switched on and HDMI compatible. (An HDMI connection can only be made with components compatible with both DVI and High Bandwidth Digital Content Protection (HDCP).) • This unit has been designed to be compliant with HDMI (High Definition Multimedia Interface) Version 1.1. Depending on the component you have connected, unreliable signal transfers may result. • Check that the PURE AUDIO indicator is not lit. If it is, press the PURE AUDIO button (See also <i>Front panel</i> on page 25). • Make sure the resolution on this player matches that of the component you have connected using HDMI. See <i>HDMI Settings</i> on page 71 to change the HDMI resolution.
No multichannel HDMI audio.	<ul style="list-style-type: none"> • Make sure the Audio setting in the HDMI menu is set to Auto (see <i>HDMI Settings</i> on page 71 to do this).
A connected HDMI component doesn't work with this player.	<ul style="list-style-type: none"> • This unit has been designed to be compliant with HDMI (High Definition Multimedia Interface) Version 1.1. Depending on the component you have connected, using a DVI connection may result in unreliable signal transfers.
Color problems occur with your monitor after changing the Video Adjust (page 58), Video Memory (page 73).	<ul style="list-style-type: none"> • You can correct this by choosing an input setting on your monitor according to the setting you've selected (see the table in the note following <i>Video Memory</i> on page 73).

i.LINK troubleshooting

Problem	Remedy
No i.LINK audio output.	<ul style="list-style-type: none"> • If the front panel i.LINK indicator is lit then: <ul style="list-style-type: none"> – Check that your AV receiver is DTCP (Digital Transmission Copy Protection) compatible. – Check that your AV receiver is compatible with the type of disc that you're trying to play (for example, SACD). • If the front panel i.LINK indicator is unlit then: <ul style="list-style-type: none"> – Check that your AV receiver is set to the correct input. – Check that the i.LINK cable is connected properly and that the cable isn't damaged. Use an i.LINK cable no longer than 3.5 meters. – Check that components connected using the i.LINK interface are switched on and i.LINK Audio compatible. Do not connect DV format players/recorders or personal computers. – Check that the i.LINK Audio Out setting is On (see <i>Audio Out</i> on page 77). – Check that the PURE AUDIO indicator is not lit. If it is, press the PURE AUDIO button (See also <i>Front panel</i> on page 25).
Auto Select Play doesn't work.	<ul style="list-style-type: none"> • Make sure that the receiver has been selected in the <i>Auto Select Play</i> on page 78. • Make sure that i.LINK Audio Out is set to On (see <i>Audio Out</i> on page 77). • Auto Select Play doesn't work while LINK CHECK shows in the front panel display (see i.LINK-related messages opposite).
i.LINK audio is temporarily interrupted.	<ul style="list-style-type: none"> • See i.LINK related messages for possible causes of this.
No multichannel i.LINK audio.	<ul style="list-style-type: none"> • For multichannel SACD playback, make sure that SACD Playback is set to Multi-ch Area (see <i>SACD Playback</i> on page 71). • For multichannel DVD-Audio playback, make sure that Audio Output Mode is set to 5.1 Channel (see <i>Audio Output Mode</i> on page 74).
Playback starts automatically when the input function of the AV receiver is changed to this player.	<ul style="list-style-type: none"> • This is an i.LINK feature and not a malfunction.
A connected i.LINK component doesn't work with this player.	<ul style="list-style-type: none"> • Depending on the connected component, this player may not work properly with it. See also the operating instructions that came with the other component.

i.LINK-related messages

You may see the following messages displayed in the front panel display when using the i.LINK interface.

LINK CHECK

The player is checking the i.LINK network. It does this, for example, when components are added or removed from the network. The sound may be interrupted if this happens during playback.

PQLS ON

Displayed when the player receives a rate control on request from the receiver during playback. The sound may be interrupted momentarily when this happens.

Note that the PQLS feature works only when the player is connected to a single receiver.

PQLS OFF

Displayed when the player receives a rate control off request from the receiver during playback. The sound may be interrupted momentarily when this happens.

LOOP CONNECT

The i.LINK network cannot function because it is connected in a loop (see *Creating an i.LINK network* on page 21).

BUS FULL

The i.LINK bus has reached its capacity and cannot transmit any more data.



Note

- Static electricity or other external influences may cause malfunctioning of this unit. In this case, unplug the power cord and then plug back in. This will usually

reset the unit for proper operation. If this does not correct the problem, please consult your nearest Pioneer service center.

Specifications

General

System	DVD Player
Power requirements	AC 120, 60Hz
Power consumption	25 W
Power consumption (standby)	0.3 W
Weight	9.0 kg (19 lb 14 oz)
Dimensions	420 (W) x 117 (H) x 340 (D) mm (16 ⁹ / ₁₆ (W) x 4 ⁵ / ₈ (H) x 13 ³ / ₈ (D) in.)
Operating temperature	+5°C to +35°C
Operating humidity	.5% to 85% (no condensation)

HDMI output

HDMI output	19 pin
-------------	--------

i.LINK output

i.LINK output	4 pin (S400)
---------------	--------------

Component Video output (Y, PB, PR)

Output level	Y: 1.0 Vp-p (75 Ω) PB, PR: 0.7 Vp-p (75 Ω)
Jacks	RCA jacks

S-Video output

Y (luminance) - Output level	1 Vp-p (75 Ω)
C (color) - Output level	.286 mVp-p (75 Ω)
Jack	S-Video jack

Video output

Output level	1 Vp-p (75 Ω)
Jack	RCA jack

Audio output (1 stereo pair)

Output level	During audio output 200 mVrms (1 kHz, -20 dB)
Number of channels	2
Jacks	RCA jack

Audio output (multi-channel / L, R, C, SW, LS, RS)

Output level	During audio output 200 mVrms (1 kHz, -20 dB)
Number of channels	6
Jacks	RCA jack

Audio characteristics

Frequency response	4 Hz to 44 kHz (DVD fs: 96 kHz) 4 Hz to 88 kHz (DVD-Audio fs: 192 kHz)
S/N ratio	118dB
Dynamic range	108.8dB

Total harmonic distortion	0.0008 %
Wow and flutter	Limit of measurement (0.001% W. PEAK) or lower

Digital output

Optical digital output	Optical digital jack
Coaxial digital output	RCA jack

Other terminals

Control in	Minijack (3.5 Ø)
Control out	Minijack (3.5 Ø)

Accessories

Stereo audio cable	1
Video cable	1
4-pin S400 i.LINK cable	1
Power cable	1
Remote control	1
AA/LR6 batteries	2
Warranty card	1
These operating instructions	1



Note

- The specifications and design of this product are subject to change without notice, due to improvement.

Should this product require service in the U.S.A. and you wish to locate the nearest Pioneer Authorized Independent Service Company, or if you wish to purchase replacement parts, operating instructions, service manuals, or accessories, please call the number shown below.

8 0 0 – 4 2 1 – 1 4 0 4

Please do not ship your product to Pioneer without first calling the Customer Support Division at the above listed number for assistance.

Pioneer Electronics (USA) Inc.
Customer Support Division
P.O. BOX 1760, Long Beach,
CA 90801-1760, U.S.A.

For warranty information please see the Limited Warranty sheet included with your product.

Should this product require service in Canada, please contact a Pioneer Canadian Authorized Dealer to locate the nearest Pioneer Authorized Service Company in Canada.
Alternatively, please contact the Customer Satisfaction Department at the following address:

Pioneer Electronics of Canada, Inc.
Customer Satisfaction Department
300 Allstate Parkway, Markham, Ontario L3R OP2
(905)479-4411
1(877)283-5901

For warranty information please see the Limited Warranty sheet included with your product.

Si ce produit doit être réparé au Canada, veuillez vous adresser à un distributeur autorisé Pioneer du Canada pour obtenir le nom du Centre de Service Autorisé Pioneer le plus près de chez-vous. Vous pouvez aussi contacter le Service à la clientèle de Pioneer:

Pioneer Electroniques du Canada, Inc.
Service à la clientèle
300, Allstate Parkway, Markham, Ontario L3R OP2
(905)479-4411
1(877)283-5901

Pour obtenir des renseignements sur la garantie, veuillez vous reporter au feuillet sur la garantie restreinte qui accompagne le produit.

S018D_enfr

Published by Pioneer Corporation.
Copyright © 2005 Pioneer Corporation.
All rights reserved

PIONEER CORPORATION

4-1, Meguro 1-Chome, Meguro-ku, Tokyo 153-8654, Japan

PIONEER ELECTRONICS (USA) INC.

P.O. BOX 1540, Long Beach, California 90810-1540, U.S.A. TEL: (800) 421-1404

PIONEER ELECTRONICS OF CANADA, INC.

300 Allstate Parkway, Markham, Ontario L3R OP2, Canada TEL: (905) 479-4411

PIONEER EUROPE NV

Haven 1087, Keetberglaan 1, B-9120 Melsele, Belgium TEL: 03/570.05.11

PIONEER ELECTRONICS ASIACENTRE PTE. LTD.

253 Alexandra Road, #04-01, Singapore 159936 TEL: 656-472-1111

PIONEER ELECTRONICS AUSTRALIA PTY. LTD.

178-184 Boundary Road, Braeside, Victoria 3195, Australia, TEL: (03) 9586-6300

PIONEER ELECTRONICS DE MEXICO S.A. DE C.V.

Bldv.Manuel Avila Camacho 138 10 piso Col.Lomas de Chapultepec, Mexico,D.F. 11000 TEL: 55-9178-4270

K002E