

Operating Instructions

LaserKaraoke

COMPACT
disc
DIGITAL AUDIO

L
LASER DISC

CD CDV LD PLAYER

CLD-1590K CLD-V720

LaserDisc

NTSC

The function of both units, CLD-1590K and CLD-V720 are identical.

- This player does not apply to business use, and CD-ROM/CD graphic discs cannot be played with this player.

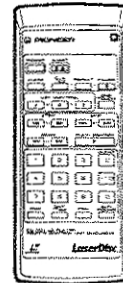
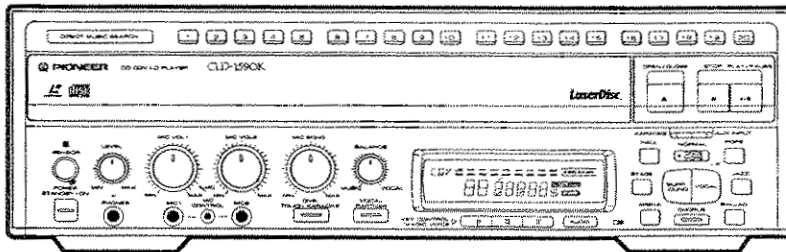

Thank you for buying this Pioneer product. Please read through these operating instructions so you will know how to operate your model properly. After you have finished reading the instructions, put them away in a safe place for future reference. In some countries or regions, the shape of the power plug and power outlet may sometimes differ from that shown in the explanatory drawings. However, the method of connecting and operating the unit is the same.

WARNING: TO PREVENT FIRE OR SHOCK HAZARD, DO NOT EXPOSE THIS APPLIANCE TO RAIN OR MOISTURE.

IMPORTANT NOTICE

[For U.S. and Canadian models]

The serial number for this equipment is located on the rear panel. Please write this serial number on your enclosed warranty card and keep it in a secure area. This is for your security.

[For Canadian model]

CAUTION: TO PREVENT ELECTRIC SHOCK DO NOT USE THIS (POLARIZED) PLUG WITH AN EXTENSION CORD, RECEPTACLE OR OTHER OUTLET UNLESS THE BLADES CAN BE FULLY INSERTED TO PREVENT BLADE EXPOSURE.

ATTENTION: POUR PREVENIR LES CHOCS ELECTRIQUES NE PAS UTILISER CETTE FICHE POLARISEE AVEC UN PROLONGATEUR, UNE PRISE DE COURANT OU UNE AUTRE SORTIE DE COURANT, SAUF SI LES LAMES PEUVENT ETRE INSEREES A FOND SANS EN LAISSER AUCUNE PARTIE A DECOUVERT.

LINE VOLTAGE SELECTOR SWITCH

Only multi-voltage models are provided with this switch. U.S., Canadian, European, U.K., and Australian models are not provided with this switch.

The line voltage selector switch is located on the rear panel of this player. Before your player is shipped from the factory, the switch is set to the power requirements of the player's destination. Check that it is set properly before plugging the power cord into the outlet. If the voltage is not properly set or if you move to an area where the voltage requirements differ, adjust the selector switch as follows:

Use a medium-sized (flat blade) screwdriver. Insert the tip of the screwdriver into the groove of the selector switch and turn it to set the player to the power voltage of your area.

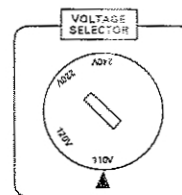

Set the selector so that arrow points power voltage of your area (Figure shows arrow pointing to 110 volts.)

PIONEER
The Art of Entertainment

IMPORTANT



The lightning flash with arrowhead, within an equilateral triangle, is intended to alert the user to the presence of uninsulated "dangerous voltage" within the product's enclosure that may be of sufficient magnitude to constitute a risk of electric shock to persons.

CAUTION
RISK OF ELECTRIC SHOCK
DO NOT OPEN

CAUTION:
TO PREVENT THE RISK OF ELECTRIC SHOCK, DO NOT REMOVE COVER (OR BACK). NO USER-SERVICEABLE PARTS INSIDE. REFER SERVICING TO QUALIFIED SERVICE PERSONNEL.



The exclamation point within an equilateral triangle is intended to alert the user to the presence of important operating and maintenance (servicing) instructions in the literature accompanying the appliance.

SAFETY INSTRUCTIONS

READ INSTRUCTIONS — All the safety and operating instructions should be read before the appliance is operated.

RETAIN INSTRUCTIONS — The safety and operating instructions should be retained for future reference.

HEED WARNINGS — All warnings on the appliance and in the operating instructions should be adhered to.

FOLLOW INSTRUCTIONS — All operating and use instructions should be followed.

CLEANING — Unplug this video product from the wall outlet before cleaning. Do not use liquid cleaners or aerosol cleaners. Use a damp cloth for cleaning.

ATTACHMENTS — Do not use attachments not recommended by the video product manufacturer as they may cause hazards.

WATER AND MOISTURE — Do not use this video product near water — for example, near a bathtub, wash bowl, kitchen sink, or laundry tub, in a wet basement, or near a swimming pool, etc.

ACCESSORIES — Do not place this video product on an unstable cart, stand, tripod, bracket, or table. The video product may fall, causing serious injury to a child or adult, and serious damage to the appliance. Use only with a cart, stand, tripod, bracket, or table recommended by the manufacturer, or sold with the video product. Any mounting of the appliance should follow the manufacturer's instructions, and should use a mounting accessory recommended by the manufacturer.

CART — An appliance and cart combination should be moved with care. Quick stops, excessive force, and uneven surfaces may cause the appliance and cart combination to overturn.



VENTILATION — Slots and openings in the cabinet are provided for ventilation and to ensure reliable operation of the video product and to protect it from overheating. These openings must not be blocked or covered. They should never be blocked by placing the video product on a bed, sofa, rug, or other similar surface. This video product should never be placed near or over a radiator or heat register. This video product should not be placed in a built-in installation such as a bookcase or rack unless proper ventilation is provided or the manufacturer's instructions have been adhered to.

POWER SOURCES — This video product should be operated only from the type of power source indicated on the marking label. If you are not sure of the type of power supply to your home, consult your appliance dealer or local power company. For video products intended to operate from battery power, or other sources, refer to the operating instructions.

POWER-CORD PROTECTION

Power-supply cords should be routed so that they are not likely to be walked on or pinched by items placed upon or against them. Pay particular attention to cords at plugs, convenience receptacles, and the point where they exit from the appliance.

POLARIZATION — This video product is equipped with a polarized alternating current line plug (a plug having one blade wider than the other). This plug will fit into the power outlet only one way. This is a safety feature. If you are unable to insert the plug fully into the outlet, try reversing the plug. If the plug should still fail to fit, contact your electrician to replace your obsolete outlet. Do not defeat the safety purpose of the polarized plug.

LIGHTNING — For added protection for this video product receiver during a lightning storm, or when it is left unattended and unused for long periods of time, unplug it from the wall outlet and disconnect the antenna or cable system. This will prevent damage to the video product due to lightning and power-line surges.

POWER LINES — An outside antenna system should not be located in the vicinity of overhead power lines or other electric light or power circuits, or where it can fall into such power lines or circuits. When installing an outside antenna system, extreme care should be taken to keep from touching such power lines or circuits as contact with them might be fatal.

OVERLOADING — Do not overload wall outlets and extension cords as this can result in the risk of fire or electric shock.

OBJECT AND LIQUID ENTRY — Never push objects of any kind into this video product through openings as they may touch dangerous voltage points or short out parts that could result in a fire or electric shock. Never spill liquid of any kind on the video product.

SERVICING — Do not attempt to service this video product yourself as opening or removing covers may expose you to dangerous voltage or other hazards. Refer all servicing to qualified service personnel.

DAMAGE REQUIRING SERVICE

Unplug this video product from the wall outlet and refer servicing to qualified service personnel under the following conditions:

- When the power-supply cord or plug is damaged.
- If liquid has been spilled, or objects have fallen into the video product.
- If the video product has been exposed to rain or water.
- If the video product does not operate normally by following the operating instructions. Adjust only those controls that are covered by the operating instructions. Improper adjustment of other controls may result in damage and will often require extensive work by a qualified technician to restore the video product to its normal operation.
- If the video product has been dropped or the cabinet has been damaged.
- When the video product exhibits a distinct change in performance — this indicates a need for service.

REPLACEMENT PARTS — When replacement parts are required, be sure the service technician has used replacement parts specified by the manufacturer or having the same characteristics as the original part. Unauthorized substitutions may result in fire, electric shock or other hazards.

SAFETY CHECK — Upon completion of any service or repairs to this video product, ask the service technician to perform safety checks to determine that the video product is in proper operating condition.

OUTDOOR ANTENNA GROUNDING — If an outside antenna is connected to the antenna terminal, be sure the antenna system is grounded so as to provide some protection against voltage surges and built-up static charges.

In the U.S.A. section 810 of the National Electrical Code, ANSI/NFPA No. 70-1984, provides information with respect to proper grounding of the mast and supporting structure, grounding of the lead-in wire to an antenna discharge unit, size of grounding conductors, location of antenna-discharge unit, connection to grounding electrodes, and requirements for the grounding electrode. See Fig. A.

NEC — NATIONAL ELECTRIC CODE

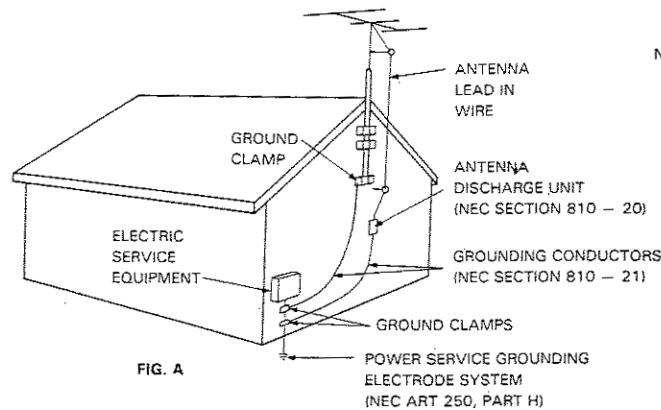

CONTENTS

<p>Precautions 4</p> <p>Features and Functions of the player 5</p> <p>Accessories 6</p> <p>Types of Discs that can be played with this Unit 7</p> <p>Care of Discs 9</p> <p>Connections 10</p> <p>Names and Functions of Front Panel Components 14</p> <p>Names and Functions of Remote Control Unit Components 16</p> <p>Remote Control Operations 17</p> <p>Before Starting Karaoke Play 18</p> <p>Enjoying Laser/CD Karaoke - Basic Operation 20</p> <p>Convenient Functions for Karaoke Play - "Mood up" Functions 22</p> <p>Convenient Functions for Karaoke Play - For Practicing 23</p>	<p>Additional Functions Possible with Other Karaoke Devices 25</p> <p>Display Switching 26</p> <p>To Play an LD, CDV or CD 28</p> <p>Extra Playback 32</p> <p>To Search for a Particular Passage (Manual Search) 32</p> <p>To Search for a Particular Chapter/Track (Chapter (Track) Search/Chapter (Track) Skip) 33</p> <p>To Search for a Particular Time/Frame (Time Number Search/Track Time Search/ABS Time Search/Frame Number Search) 34</p> <p>To Repeatedly Play a Desired Passage (Repeat Playback) 35</p> <p>To Play Only the Desired Scenes/Tracks (Program Playback) 36</p> <p>Troubleshooting 38</p> <p>Specifications 42</p>
--	--

CAUTION

- Use of controls or adjustments or performance of procedures other than those specified herein may result in hazardous radiation exposure.
- The use of optical instruments with this product will increase eye hazard.

[For Canadian model]

This digital apparatus does not exceed the Class B limits for radio noise emissions from digital apparatus set out in the Radio Interference Regulations of the Canadian Department of Communications.

INFORMATION TO USER [FOR U.S. MODEL]

This equipment generates and uses radio frequency energy and if not installed and used properly, that is, in strict accordance with the manufacturer's instructions, may cause interference to radio and television reception. It has been type tested and found to comply with the limits for a Class B computing device in accordance with the specifications in Subpart J of Part 15 of FCC Rules, which are designed to provide reasonable protection against such interference in a residential installation. However, there is no guarantee that interference will not occur in a particular installation.

If this equipment does cause interference to radio or television reception, which can be determined by turning the equipment off and on, the user is encouraged to try to correct the interference by one or more of the following measures:

- reorient the receiving antenna
- relocate this equipment with respect to the receiver
- move this equipment away from the receiver
- plug this equipment into a different outlet so that equipment and receiver are on different branch circuits.

If necessary, the user should consult the dealer or an experienced radio/television technician for additional suggestions. The user may find the following booklet prepared by the Federal Communications Commission helpful:

"How to Identify and Resolve Radio-TV Interference Problems".

This booklet is available from the US Government Printing Office, Washington, D.C., 20402, Stock No. 004-000-00345-4.

The above instructions apply only to units which will be operated in the United States.

■ This player may be used with LaserDiscs, Compact Discs, and Compact Discs with Video bearing the following symbols:

(LASERDISC SYSTEM)/(LaserVision Disc)*



This is the unified symbol mark of LASERDISC (LaserVision videodisc).

* LaserDisc players and discs which bear this symbol and use the same television system, are mutually compatible.

(Compact Disc)



(CD VIDEO SYSTEM)**



(3-inch Compact Disc)



** A Digital Sound with Multi Audio Discs (CD VIDEO LD) and a CDV (CD Video CDV) are referred to as CD Video discs. CD Video discs are recorded with subcodes, which are the non-audio recordings of TOC data such as track numbers, index numbers, etc. However, there are some discs without these marks.

Only one disc can be loaded at any one time. Loading a LaserVision Disc, a Compact Disc, a 3" Compact Disc or a Compact Disc with Video on top of one another may result in breakdown, or in scratching of the discs. Please only load one disc at a time.

This player is to be used exclusively with the NTSC color system. Please use NTSC LaserVision Disc or NTSC Compact Disc with Video only. PAL and SECAM system discs cannot be used with this player.

FEATURES AND FUNCTIONS OF THE PLAYER

Rich Variety of Karaoke Functions

Direct Selection Function Enables You to Directly Select the Song You Wish to Sing

Using the DIRECT MUSIC SEARCHs on the front panel, you can select any song up to the 20th song by simply pressing a single button.

Two Independent Microphone Systems Enable You to Separately Adjust the Sound Volume for Each Mike

Since two independent microphone systems are provided, you can independently adjust the level for each microphone.

Surround Function Creates a Live Atmosphere

Three modes are available: Hall, Stage and Arena. Select the mode which best suits the atmosphere of the song or your mood. This surround function uses advanced digital technology based on a DSP (digital signal processor). The audio signal is processed digitally for accurate, high-quality sound field reproduction.

Vocal Effect Function Matches the Vocal Sound to the Music Genre

Use this function to create crisp, high vocals, low, resounding vocals or reverberating vocals to match the mood or genre of the song. A chorus function is also provided for making the voice of one person sound like two or three. Like the surround function, the vocal effect function uses a DSP for superior sound quality.

Vocal Partner Function Replaces the Original Vocal Sound with Your Own Voice

If you press VOCAL PARTNER and sing into the microphone, the original vocals will be cut out and replaced with your own voice.

One-Touch Karaoke Function Allows You to Enjoy Karaoke Using Ordinary Music Discs

Press ONE-TOUCH KARAOKE and the original vocal sound of an ordinary music disc will be played at low volume, enabling you to use the disc as a karaoke disc.

Key Control Function Changes the Pitch of the Instrumental Part to Match Your Voice

By pressing the KEY CONTROL buttons, you can change the pitch within an 8-step range.

Magic Voice Function Allows You to Freely Change the Sound of Your Voice

By operating the KEY CONTROL buttons, you can freely heighten or lower the pitch of your voice.

Once More Function Enables You to Quickly Repeat the Section You Just Sang

If you press ONCE MORE once, playback returns to a point approximately 5 seconds before the current location in the song.

One-Song Pause Function

Playback automatically pauses after one song selected is played.

LD (LaserVision Disc) Playback Functions

Program Playback

Up to 24 chapters can be selected from a disc and played in any desired order.

Still Frame Playback (CAV discs only)

Still frame playback and Frame Advance Playback (forward/reverse) are also available.

Repeat Playback

Three repeat modes - 1-chapter Repeat, One-side Repeat and Program Repeat - are available.

Time/Frame Search

Any desired scene can be searched for by specifying its time/frame number.

CD (Compact Disc) Playback Functions

Program Playback

Up to 24 tracks can be selected from a disc and played in any desired order.

Repeat Playback

Three repeat modes - 1-Track Repeat, All-track Repeat and Program Repeat - are available.

Track Time Search

Any desired point can be searched for by specifying track time on a specified track.

CDV (Compact Disc with Video) Playback functions

* The video part (the section of the disc containing both video and audio) is played first.

Video Part:

The same functions available for LD (CLV) playback can be used.

Audio Part:

The same functions available for CD playback can be used.

PRECAUTIONS

If it becomes necessary to transport or ship this unit in the future, be sure to first remove the disc (if present); retract the disc table to its closed position, turn the power off and disconnect the power cord.

INSTALLING THE PLAYER

- Place the player on a stable platform next to the television and stereo system to be used with the player.
- When using the player with a stereo system, your speakers should be placed away from your television (or TV monitor).
- Do not place heavy objects such as a television or TV monitor on top of the player.
- Do not place the player on top of your TV set or TV monitor. Also, keep the player away from devices such as cassette decks which are sensitive to magnetic fields.

When FM or AM stations are being received, signal noise may be generated if the player is turned on. Turn off the player when not in use. Also, if there is signal noise when receiving radio stations with an indoor antenna, adjust the position or direction of the antenna.

INSTALL THE PLAYER IN A WELL VENTILATED PLACE AWAY FROM HEAT AND HUMIDITY

Do not install the player in a location subject to direct sunlight, or near a stove or radiator etc. This could adversely affect the cabinet and internal components. Also avoid installing the player in a humid or dusty location. This could result in a malfunction or accident. Do not install near a cookstove where the player could be affected by smoke, steam, or heat.

AVOID SOURCES OF HEAT

Do not put the player on sources of heat, such as an amplifier. When installing with audio components on a rack, avoid components that generate heat, by placing the player below such components where there is adequate ventilation and not much dust. Avoid placing the player on surfaces such as shaggy carpets, beds, and sofas which may block ventilation under the player and cause damage.

CAUTIONS FOR AUTOMATIC LOADING OPERATIONS

Since this player has an automatic loading construction, use the button on the player or the remote control unit for opening and closing of the disc table. To avoid damage, be careful not to apply any force to the moving disc table.

STRIPE PATTERNS APPEARING ON A TV PROGRAM

Stripe patterns may appear during a TV program if the player unit is turned on, depending on the quality of reception of the TV station. This is neither a malfunction of the television nor the player. If stripes appear while watching the TV, or when watching the TV for long periods of time, turn the player off.

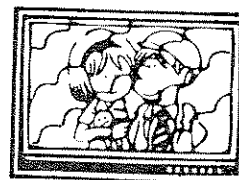

CONDENSATION

Moisture will form in the operating section of the player if the player is brought from cool surroundings into a warm room or if the temperature of the room rises suddenly. When this happens, player's performance will be impaired.

To prevent this, let the player stand in its new surroundings for about an hour before switching it on, or make sure that the room temperature rises gradually.

The same, symptoms of condensation may be caused during summer, if the player is exposed to the breeze from an air conditioner. In such cases change the location of the player.

POWER-CORD CAUTION

Handle the power cord by the plug. Do not pull out the plug by tugging the cord and never touch the power cord when your hands are wet as this could cause a short circuit or electric shock. Do not place the unit, a piece of furniture, etc., on the power cord, or pinch the cord. Never make a knot in the cord or tie it with other cords. The power cords should be routed such that they are not likely to be stepped on. A damaged power cord can cause fire or give you an electrical shock. Check the power cord once in a while. When you find it damaged, ask your nearest PIONEER authorized service center or your dealer for a replacement.

CLEANING CARE

Use a soft, dry cloth for cleaning. For stubborn dirt, soak the cloth in a weak detergent solution; wring well first and wipe. Use a dry cloth to wipe it dry. Do not use any volatile agents such as benzine or paint thinner, as it may damage the surface of the player.

Abnormal functioning of this unit may be caused by lightning, static electricity, or other external interference. To restore normal operation, turn the power off and then on again, or unplug the AC power cord and then plug it in again.

FEATURES AND FUNCTIONS OF THE PLAYER

Other Features

Auto Loading and Automatic Disc Discrimination Functions

This unit has a built-in motor-driven auto loading mechanism which automatically opens and closes the disc table and makes disc loading easy.

Also, once a disc is placed on the table and the table is retracted into the player, the player automatically detects which type of disc (LD, CD, or CDV) is loaded.

Zero-Cross Distortion-Free D/A Converter

Digital-to-analog conversion is smoother than ever. In particular, this converter is designed to eliminate zero-cross glitching noise and improves linearity in lower levels, with the noise shaping technology doubly applied at digital filter and digital-to-analog conversion steps, all for smoother and more accurate D/A signal conversion. The result is deep, clear sound with sharp image localization.

Compatibility with Many Disc Types and Sizes

In addition to conventional LDs (12-inch, 8-inch), CDs (5-inch), and CDV discs (5-inch), the player can play thin-type 8-inch LDs and 3-inch CD singles without an adapter.

ACCESSORIES

When unpacking the player, first check to make sure that all of the accessories listed below are supplied.

- Remote control unit
- Size "AAA" (IEC R03) dry cell battery x 2

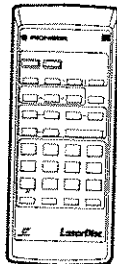

- Video cord
(Pin plug ↔ Pin plug)
Use to connect the player to a color monitor etc.

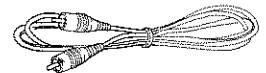

- Audio cord
(Pin plug x 2 ↔ Pin plug x 2)
Use to connect the player to a stereo amplifier etc.

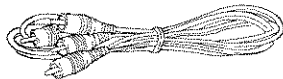









- Operating instructions
- Warranty card

TYPES OF DISCS THAT CAN BE PLAYED WITH THIS UNIT

This unit is a CD VIDEO SYSTEM (*1) compatible player which can play CDs, CDV discs, and LDs. The five disc types listed in the table below can be played with this unit.

- The marks shown in the left column are printed on the labels and jackets of the corresponding discs.

Mark	Disc	Size	Number of recorded sides	Audio recording system	Video recording system	Other
	CD (Compact Disc) Single	3-inch	One side	Digital (20 minutes max.)		TOC (*2)
	CD (Compact Disc)	5-inch	One side	Digital (74 minutes max.)		TOC
	CDV (CD with Video)	5-inch	One side	Digital (20 minutes max./ 5 minutes max.)	CLV (*3) (5 minutes max.)	TOC *
	CDV VIDEO SINGLE VIDEO SINGLE DISC 	5-inch	One side	Digital (5 minutes max.)	CLV (*3) (5 minutes max.)	TOC *
	CD VIDEO LD (*4)	12-inch, 8-inch	Two sides, one side	Digital/analog	CAV (*5) CLV	TOC **
	LD (LASERDISC/ LaserVision Disc)	12-inch, 8-inch	Two sides, one side	Digital/analog (*6) or analog only	CAV, CLV	

* There are some discs marked with the  mark instead of the  mark.

** There are some discs without the  mark.

LD GLOSSARY

Chapter number

Chapter numbers are used to indicate the boundaries of the sections on a disc, similar to the "chapters" in a book. If chapter numbers are recorded on a disc, it is so indicated on the jacket of the disc, etc. Chapter numbers can be used to search for desired chapters (Chapter Search).

Frame number

Frame numbers are the numbers assigned to each picture frame on a CAV (standard play) disc. Frame numbers can be used to search for desired frames (Frame Search).

Time number

Time numbers indicate the time elapsed from the beginning of a CLV (extended play) disc. Time numbers can be used to search for desired scenes (Time Search).

CDV/CD GLOSSARY

Track number

Track numbers indicate the boundaries of the sections, or "tracks", on a disc. Track numbers are assigned consistently throughout the audio part and video part of a CDV disc. Track numbers can be used to search for desired tracks (Track Search).

TOC (*2)

Every CD/CDV-type disc is provided with a section called TOC (Table Of Contents) at the beginning of the disc. The TOC section is just like the table of contents of a book, and contains information on the contents (number of tracks, playing time, etc.) of the disc.

- Some LD discs are also provided with a TOC section.

CD VIDEO SYSTEM (*1)

The CD VIDEO SYSTEM is the standard name for the "optical video disc with digital audio" system that encompasses both LDs and CDV discs.

The following mark is the standard mark for the CD VIDEO SYSTEM and is found on all players and discs which conform to the CD VIDEO SYSTEM format.

The following systems are included in the CD VIDEO SYSTEM:



- CDV (CD VIDEO CDV) discs
- LaserVision Discs (CD VIDEO LDs) containing digital sound with sub-codes
- Compatible players which can play CDs and CDV discs
- Compatible players which can play CDs, CDV discs, and LDs

CD VIDEO LDs (*4)

A CD VIDEO LD is an LD with digital audio which is encoded with sub-codes (data such as TOC and track number data, excluding audio and video signals).

LDs (LASERDISCS)

With this unit, only play LaserDiscs which bear the following mark.

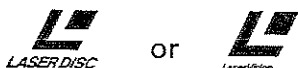

This mark is the standard mark for LaserDiscs.

Players and discs which bear the LaserVision mark are mutually compatible as long as they conform to the same television system.

Two types of standard LaserDisc are available — standard play (CAV) (*5) discs and extended play (CLV) (*3) discs — which differ with respect to their signal recording systems.

CAV (*5) DISCS

The jackets and labels of these discs are marked with a "Standard Play Disc CAV" or "Standard Play" indication.

Frames are recorded on these discs at a ratio of one frame per disc revolution, and the discs are played at a fixed rotational speed (CAV = Constant Angular Velocity) of 1,800 rpm. This system is well suited to special playback modes such as still frame playback and multi-speed playback. One side of a CAV disc can have a playback time of up to 30 minutes (for a 12-inch disc), which is equivalent to 54,000 frames. Each frame — from frame 1 to frame 54,000 — is encoded with its own frame number.

* Playback time varies according to the contents of the disc.

CLV (*3) DISCS

The jackets and labels of these discs are marked with a "Extended Play Disc CLV" or "Extended Play" indication.

Signals are recorded on these discs at a constant linear velocity (CLV), and the rotational speed during playback varies from 1,800 rpm for the innermost track to 600 rpm for the outermost track. As a result, one side of a CLV disc can have a playback time of up to 60 minutes (for a 12-inch disc), which is twice as long as a standard play (CAV) disc. CLV discs are encoded with time numbers which correspond to the elapsed play time from the beginning of the disc.

* Playback time varies according to the contents of the disc.

LASERVISION DISCS WITH DIGITAL AUDIO (*6)

The jackets and labels of these discs bear the following mark.

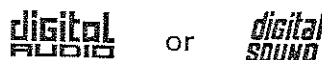

These are LaserDiscs which contain digital audio signals in addition to conventional analog audio signals. This feature allows the high image quality of LaserDiscs to be enjoyed together with the superior quality of digital sound. The digital and analog audio signals are recorded on the disc using different frequency bands.

LASERVISION MULTI AUDIO DISCS WITH DIGITAL AUDIO

The jackets and labels of these discs bear the following mark.

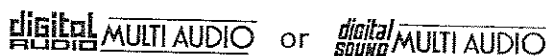

These are LaserDiscs in which the recorded digital and analog audio signals differ in content. This allows the user to enjoy two different audio soundtracks by switching between the digital and analog sound.

CDV (COMPACT DISC WITH VIDEO) DISCS

These are compact discs which also contain video signals. Of the total 25-minute playback time of a CDV disc, 20 minutes is encoded with conventional CD digital audio signals (the "audio part"). The remaining 5 minutes is encoded with both video and digital audio signals (the "video part").

CARE OF DISCS

How to hold discs.

When loading or removing discs, try not to touch their playing surfaces.

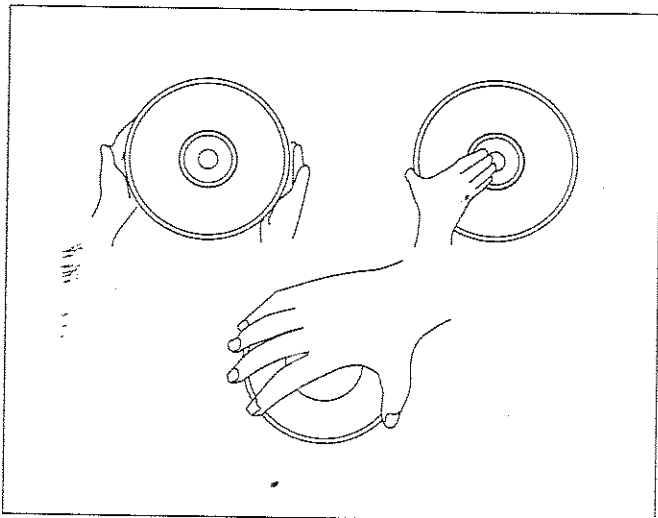

Cleaning

Fingerprints or other dirt on the disc may affect sound and picture quality.

To clean your discs, use a soft clean cloth to wipe them. If necessary, moisten a soft cloth with diluted neutral detergent to remove heavy dirt or fingerprints.

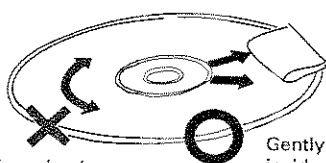

Do not wipe in a circular direction

Gently wipe from the inside toward the outer edge.

Discs may not be cleaned with record cleaning sprays, or static prevention sprays, etc. Also do not use volatile liquids such as benzene, or thinner, etc.

NEVER PLAY CRACKED OR WARPED DISCS.

■ The disc revolves on the player at a high speed when it is played. Never play a cracked, scratched or warped disc. This may damage the player or cause it to malfunction.

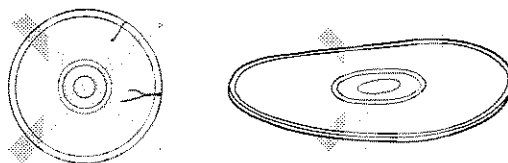

After using discs, store them upright

After playing a disc, always remove it from the player and return it to its jacket. Then store it standing upright away from heat and humidity.

- Store discs carefully. If you store discs at an angle, or stacked on top of each other, discs may become warped even when in their jackets.
- Do not leave discs in locations such as the seat of car, which may become excessively hot.

If an LD disc is warped...

If an LD disc is warped, put the disc into its protective envelope, and then place it between two flat plates of glass. Then place heavy books on top of the plates so that approximately 4 to 5 kgs (10 lbs) is applied. Leave the disc like this for a day or so. This may correct the warp.

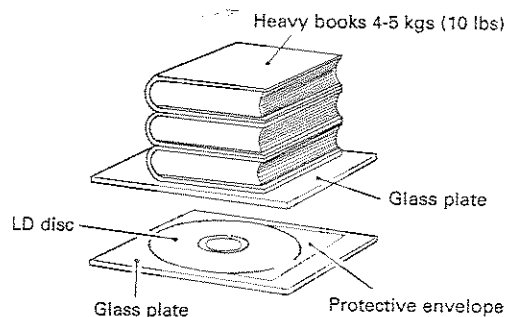

CAUTION WHEN USING THE DISC

All rights reserved.

Unauthorized public performance, broadcasting or copying is a violation of applicable laws.

CONNECTIONS

USING TELEVISION WITH AUDIO AND VIDEO JACKS

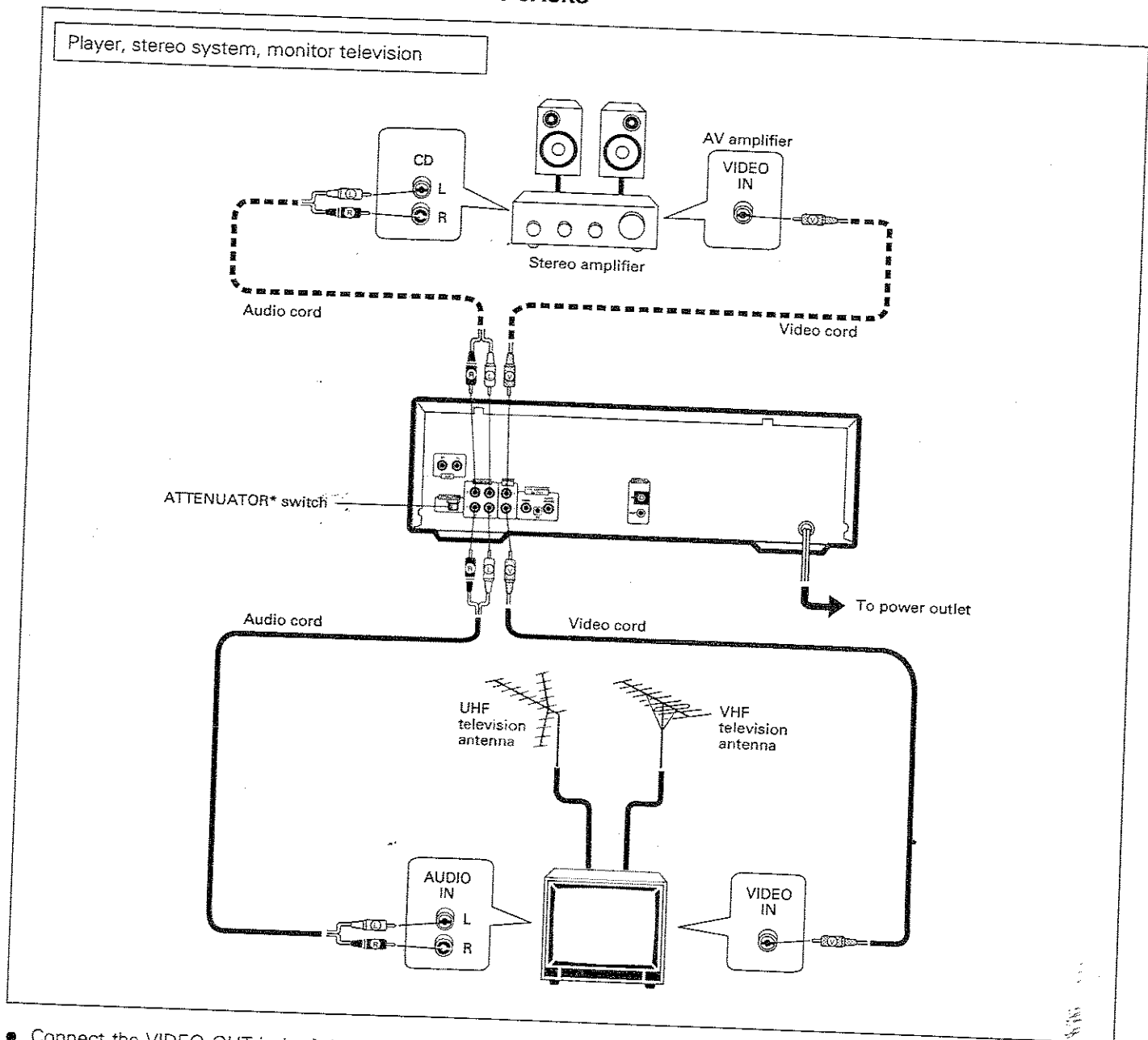

- Connect the VIDEO OUT jack of the player to the video input jack of the monitor television.
- Connect the AUDIO OUT jacks to the stereo amplifier AUX, CD, LD, VDP or other jacks, except the PHONO input jacks. The television speakers can also be used by connecting the television audio input jacks and the player AUDIO OUT jacks, however connection to a stereo amplifier is recommended to obtain superior audio playback quality for Compact Discs and LaserDiscs. Do not change the television antenna and VCR connections.
- Connect the power cord to an AC wall outlet.

- Combined system control is possible when a Pioneer television and audio/video stereo receiver are connected. Refer to page 13 for an explanation of the connection procedure.

*ATTENUATOR switch

When the television speakers are used, the sound may be distorted. In this case, set ATTENUATOR to ON to reduce the distortion.

USING TELEVISION WITHOUT AUDIO AND VIDEO JACKS (WITH OPTIONAL RF MODULATOR JA-RF3L) (CLD-V720 only)

Player, regular television, stereo system

The numbers are explained on the next page. Make the connections in this order.

- To watch a TV broadcast, turn off the power of this player.
- When the power of this player is turned on, LD playback can be seen on the screen.

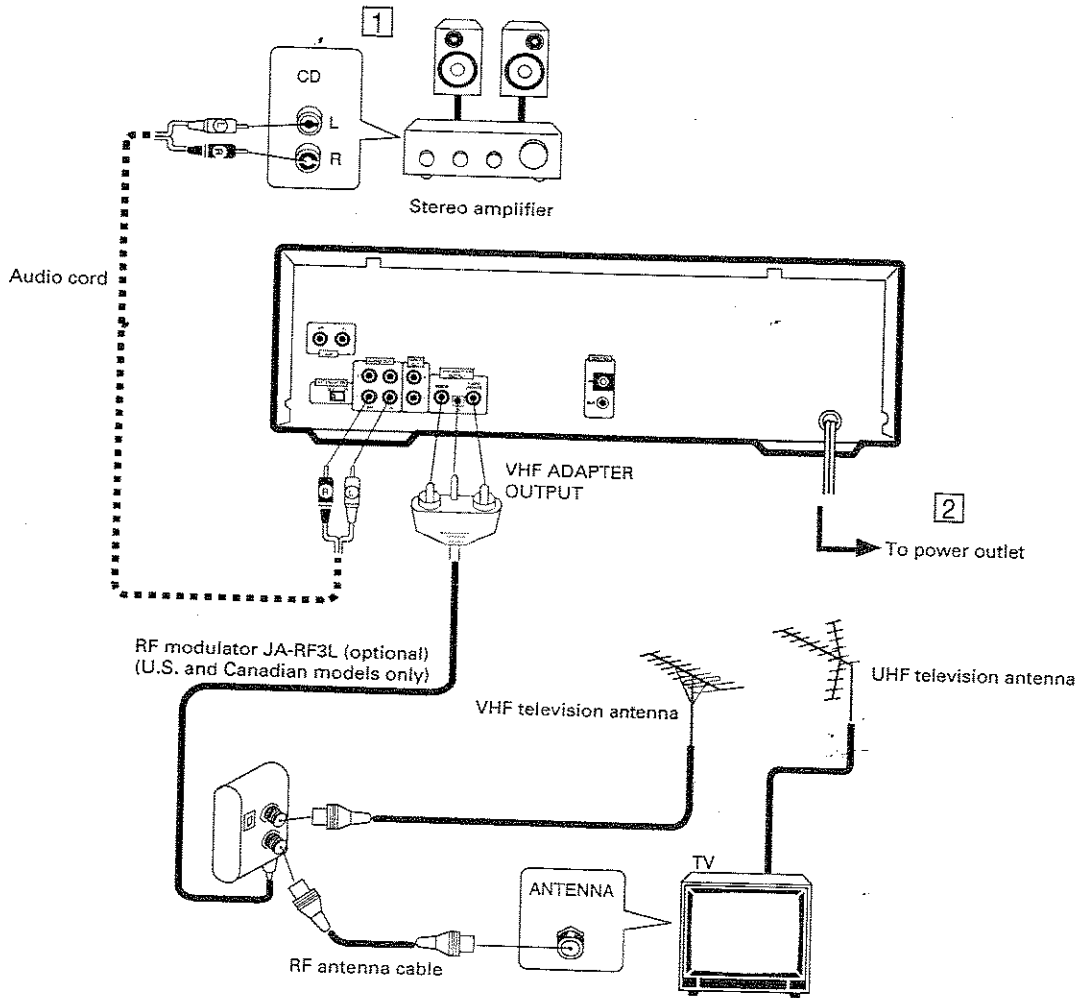

1. Detach the VHF antenna cable from the VHF antenna terminal of your TV set, and connect the cable to the VHF IN terminal of the RF modulator JA-RF3L (optional).
2. Connect the VHF OUT terminal of the RF modulator to the VHF antenna terminal of your TV set with the supplied RF cable.
3. Connect the socket (3-pin) of the RF modulator to the VHF ADAPTER OUTPUT jacks.

NOTES:

- Push the plug in firmly. If the plug is not properly inserted, it may result in snow on the screen or noise.

When the sound from a LaserDisc or Compact Disc is output from a television speaker it becomes monaural sound. (This is the same as stereo television).

NOTE:

- Stripe patterns may appear when a LaserDisc is played on a television. Move the antenna cable away from the power cord to avoid this.
- Be sure to turn off the power of this player when you watch a TV broadcast.

1 CONNECTING TO YOUR STEREO AMPLIFIER

Connect the AUDIO OUT jacks of the player to the AUX, CD, LD or VDP input jacks of your stereo amplifier.

NOTE:

- Do not connect these jacks to your amplifier PHONO input jacks.

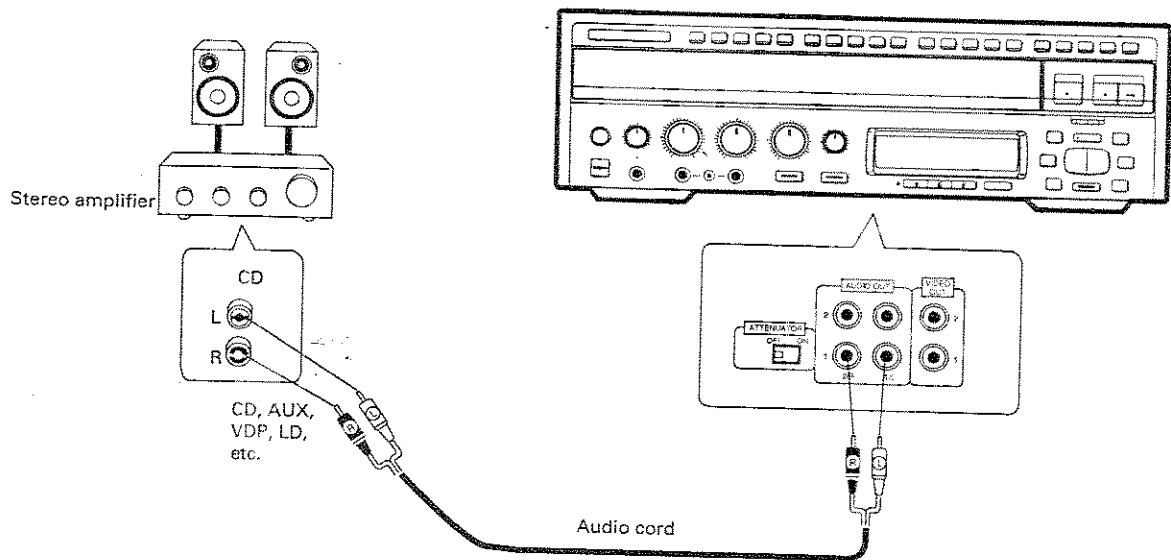

2 PLUG THE POWER CORDS INTO AC OUTLET

Plug the AC power cords of the player, stereo amplifier and TV set into an AC outlet.

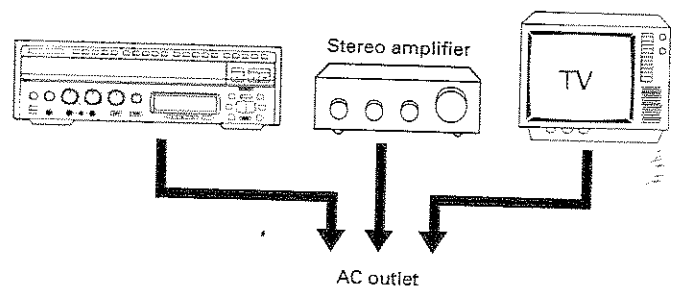

SYSTEM REMOTE CONTROL CONNECTION

WHEN COMBINED WITH OPTIONAL PIONEER PROJECTION MONITOR (or COMPONENT DISPLAY)

Connect the VIDEO OUT jack of the player to the video input jack of the projection monitor (or component display), and connect the AUDIO OUT jacks of the player to the audio input jacks of the projection monitor (or component display).

System Control

By connecting the CONTROL IN jack of the player to the remote jack of the projection monitor (or component display), the system can be controlled by the remote control unit of the player at the remote control sensor of the projection monitor (or component display).

- Use a commercially available cord with mini-plugs for the connection.

Please also refer to the operating instructions for the projection monitor (or component display).

NOTE:

When system control connections have been made, the player cannot be directly controlled by the remote control unit. To operate the player, aim the remote control unit at the projection monitor (or component display).

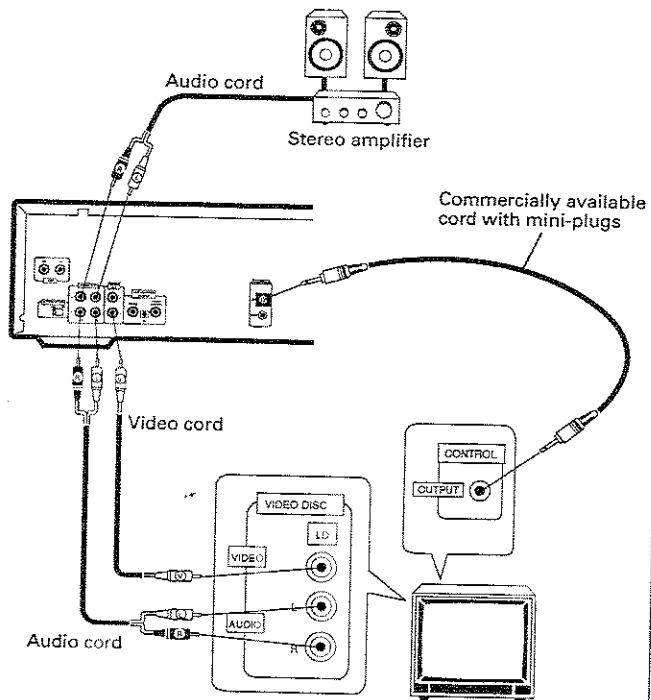

PERFORMING SYSTEM CONTROL WHEN THE PLAYER IS COMBINED WITH A PRODUCT THAT HAS THE SR MARK

System control can be performed when the player is combined with an optional AV control center, which can provide centralized control of Pioneer products with the SR mark.

Connect the VIDEO OUT jack of the player to the video disc video input jack of the AV control center and connect the AUDIO OUT jacks of the player to the audio input jacks of the AV control center.

Connect the CONTROL IN jack of the player to the CONTROL OUT jack of the AV control center using a commercially available cord with mini-plugs.

- For details concerning the connection and operation methods, please refer to the operating instructions for the AV control center.

NOTE:

When a connecting cord has been connected to the CONTROL IN jack, direct control of the player with the remote control unit is not possible. Operate the player with the remote control unit by aiming it at the AV control center.

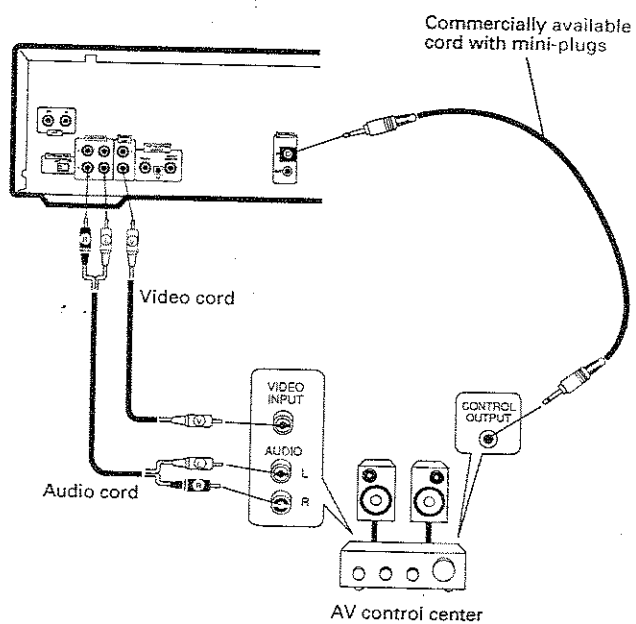

NAMES AND FUNCTIONS OF FRONT PANEL COMPONENTS

- Most of the buttons on the front panel are used for Karaoke play.
- A detailed description is provided on the indicated page(s).

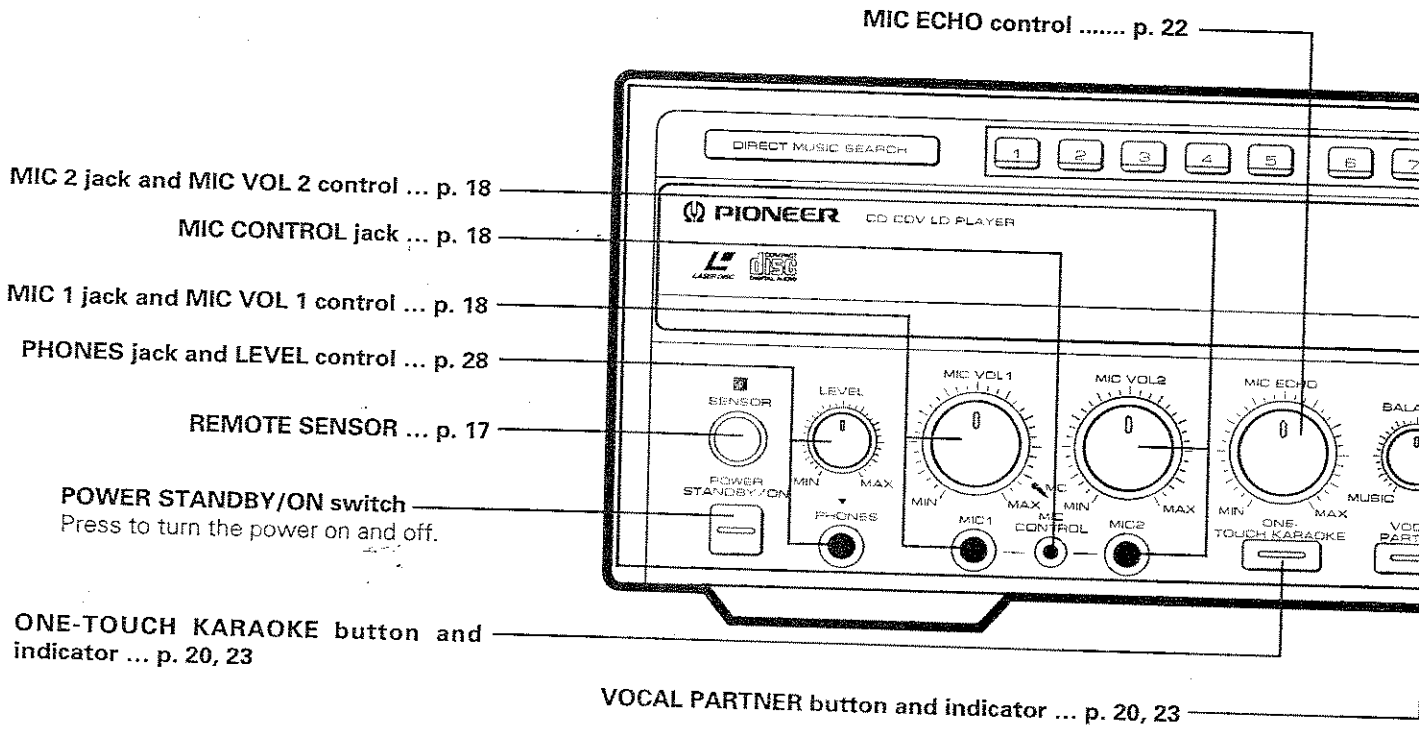

Display window

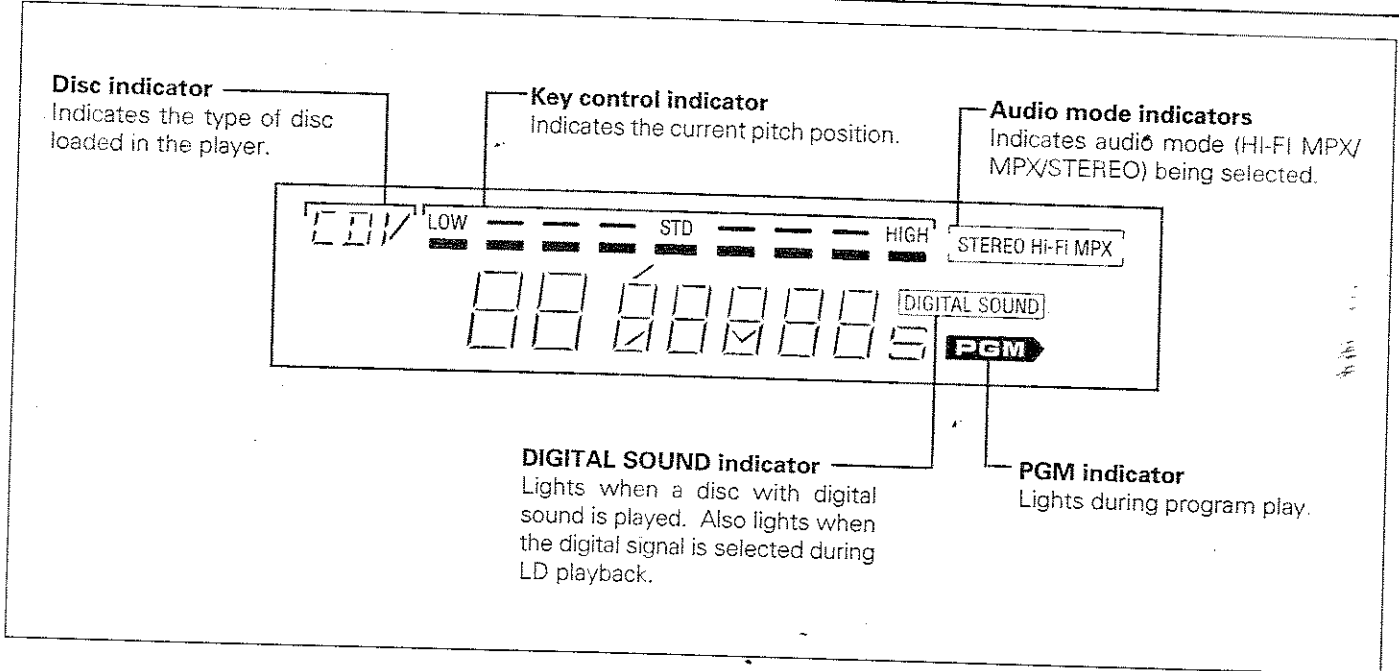

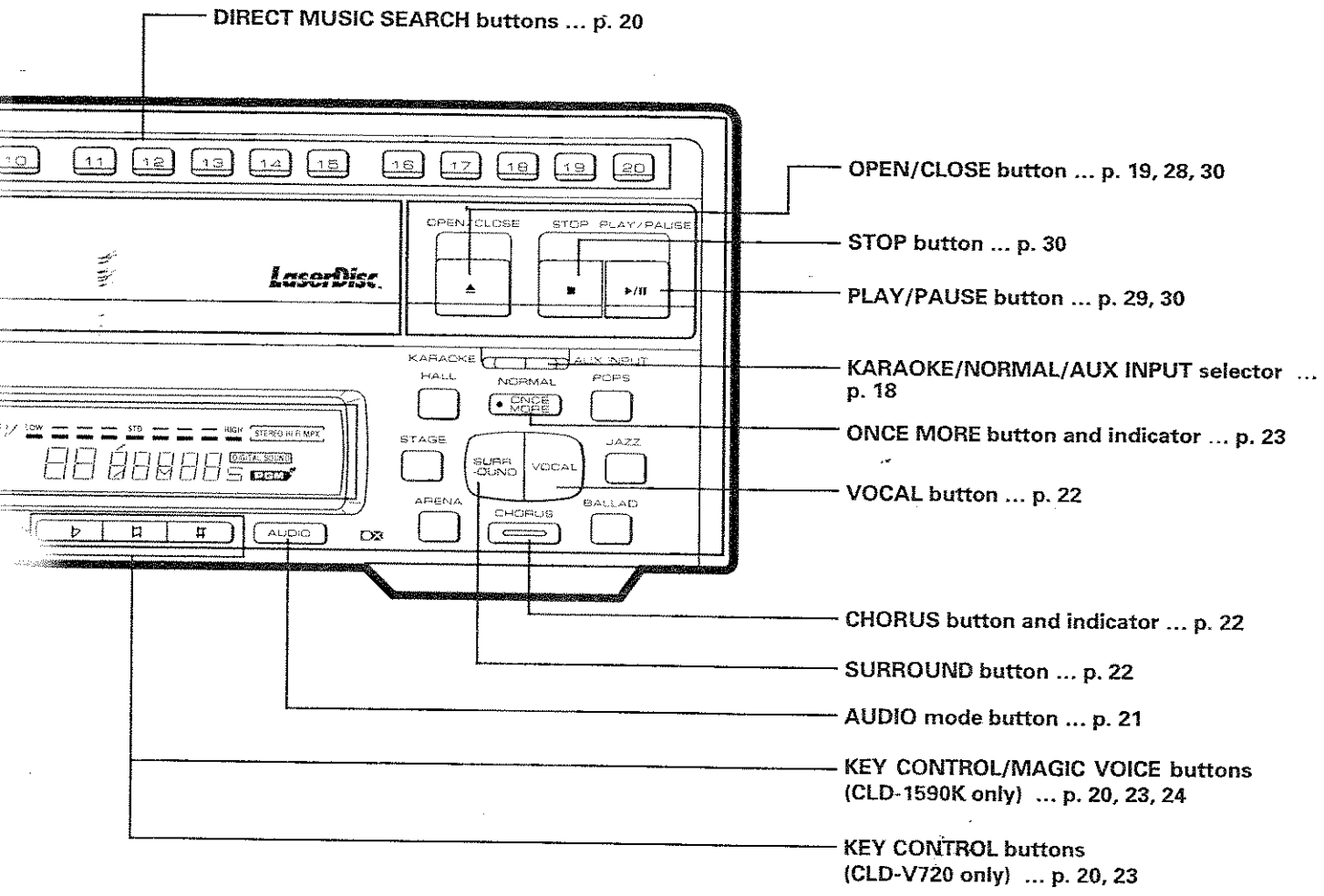

DIRECT MUSIC SEARCH buttons ... p. 20

OPEN/CLOSE button ... p. 19, 28, 30

STOP button ... p. 30

PLAY/PAUSE button ... p. 29, 30

KARAOKE/NORMAL/AUX INPUT selector ... p. 18

ONCE MORE button and indicator ... p. 23

VOCAL button ... p. 22

CHORUS button and indicator ... p. 22

SURROUND button ... p. 22

AUDIO mode button ... p. 21

KEY CONTROL/MAGIC VOICE buttons (CLD-1590K only) ... p. 20, 23, 24

KEY CONTROL buttons (CLD-V720 only) ... p. 20, 23

NAMES AND FUNCTIONS OF REMOTE CONTROL UNIT COMPONENTS

- A detailed description is provided on the indicated page(s).
- Remote control buttons with the same names or marks as buttons on the front panel of the player control the same operations as the corresponding front panel buttons.
- Most of the buttons on the remote control unit are used for Disc playback explained from on page 26.

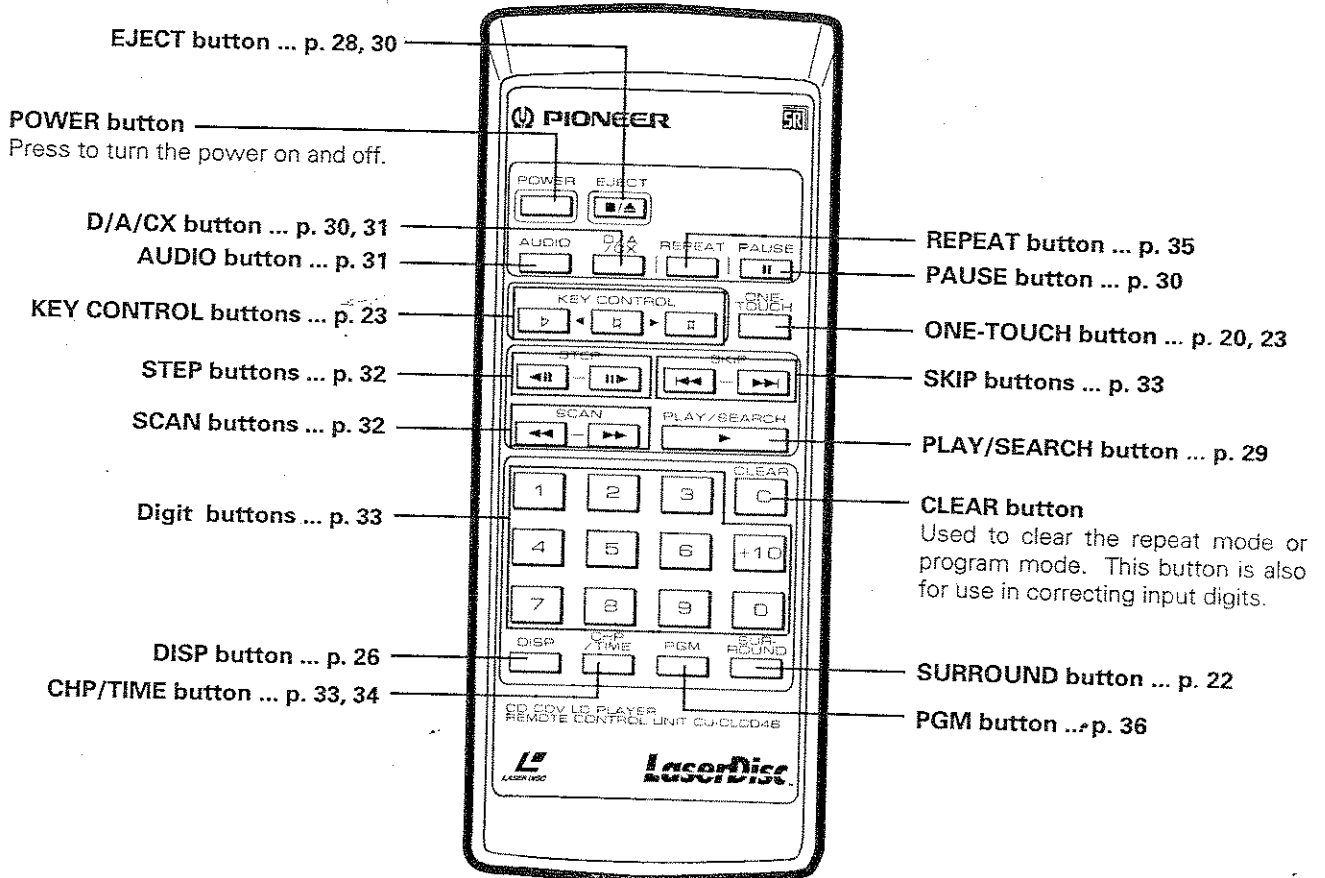

REMOTE CONTROL OPERATIONS

INSERTING BATTERIES INTO THE REMOTE CONTROL UNIT

- 1 Open the battery compartment cover on the back of the remote control unit. The cover should open easily if you press on it with your thumb while sliding it in the direction of the arrow.
- 2 Take out the two accessory size "AAA" (IEC R03) dry cell batteries, and insert them into the battery compartment in accordance with the display (⊕, ⊖) inside the compartment.
- 3 Close the cover of the battery case.

Incorrect use of batteries may cause leakage or rupture. Always be sure to follow these guidelines:

- A. Always insert batteries into the battery compartment correctly matching the positive (⊕) and negative (⊖) polarities, as shown by the display inside the compartment.
- B. Never mix new and used batteries.
- C. Batteries of the same size may have different voltages, depending on brand. Do not mix different brands of batteries.

When operating the remote control unit, point the unit's infrared signal transmitter at the remote control receiver (REMOTE SENSOR) on the front panel of the player. The remote control unit can be used within a range of about 7 meters (23 feet) from the remote sensor, and within angles of up to about 30 degrees.

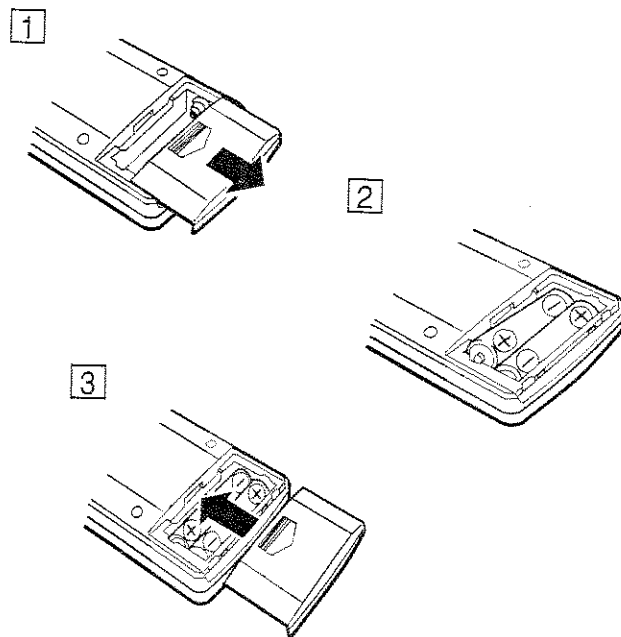
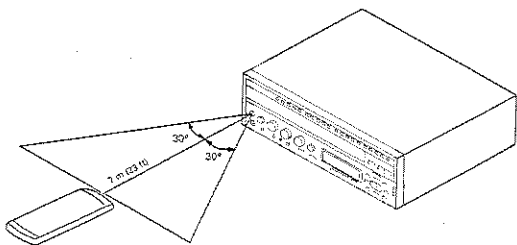

NOTE FOR USING THE REMOTE CONTROL UNIT

- If a plug is connected to the CONTROL IN terminal at the rear of the player, remote control operations cannot be done with the remote control unit aimed at the player's remote control sensor. Aim the remote control unit at the AV control center or the component display's sensor instead.
- If there is any obstacle between the remote control unit and the player, or if the unit is held at too large an angle relative to the front panel of the player, the signal from the remote control unit will fail to reach the remote sensor.
- If the player is operating in the vicinity of other appliances generating infrared rays, or if other remote control devices using infrared rays are used near the player, the player may operate improperly. Conversely, if the player's remote control unit is operated in the vicinity of other appliances which use an infrared remote control device, the other appliance may operate improperly. If this should happen, change the place of installation so that improper operation does not occur.
- If the range of operation of the remote control unit becomes too short, replace the batteries.
- When the unit is not to be used for a long period of time (more than one month), remove the batteries to prevent them from leaking inside the compartment. If leakage occurs, wipe up the liquid inside the compartment and replace the batteries with new ones.
- Do not place books or other objects on the remote control unit, since they might depress the buttons and run down the batteries.
- If the remote control sensor window is in a position where it receives strong light such as sunlight or fluorescent light, control may not be possible.

BEFORE STARTING KARAOKE PLAY

- Turn on the power to the monitor TV and/or audio system.
- Before starting karaoke play, carry out the following operations in the sequence indicated below.
- Operations indicated by the [] mark are performed with the remote control unit.

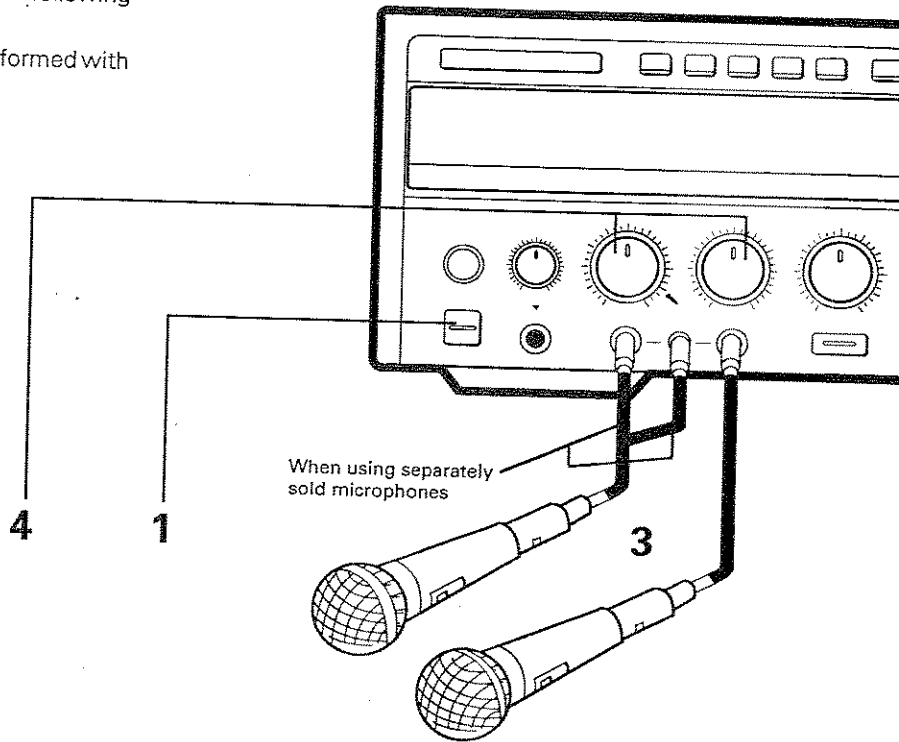

1

Turn on the power to the player.

POWER
STANDBY/ON



or

POWER



2

Set the player to KARAOKE mode.

KARAOKE  AUX INPUT
NORMAL



For karaoke play, always set this selector to KARAOKE to set the player to KARAOKE mode.

3

Connect and turn on the microphone(s).

- To MIC 1 or MIC 2.
- To MIC 1 and MIC 2 for duets.

About microphones

When using a separately-sold microphone such as the Pioneer Microphone DM-V161, connect the control-use miniplug to the player's MIC CONTROL ( MC) jack.

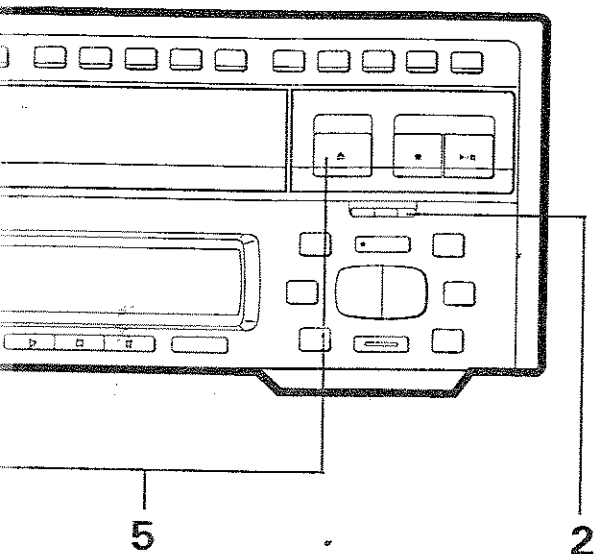

4

Adjust the microphone level.

For MIC 1

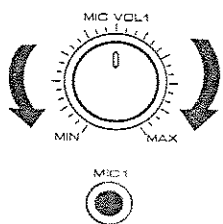

For MIC 2

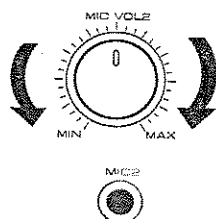

Adjust the microphone level while speaking into the microphone. (You can also adjust the level while singing during karaoke play.)

NOTE:

If howling (a high-pitched sound) occurs, decrease the microphone level, separate the microphone farther from the speaker(s), or lower the sound volume of the TV. (If using a stereo amplifier, lower the amplifier's sound volume.)

5

Load a disc.

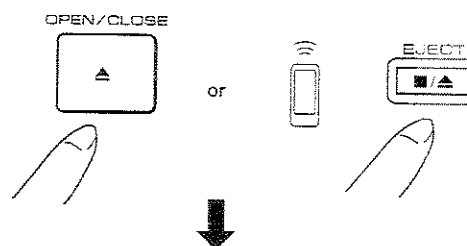

As shown in the following diagram, place the disc on the disc table in the groove corresponding to the size of the disc.

If the disc is not centered correctly on the disc table, the disc will not be played or the disc and/or the player may be damaged.

Always place the disc correctly according to the required disc size on the disc table.

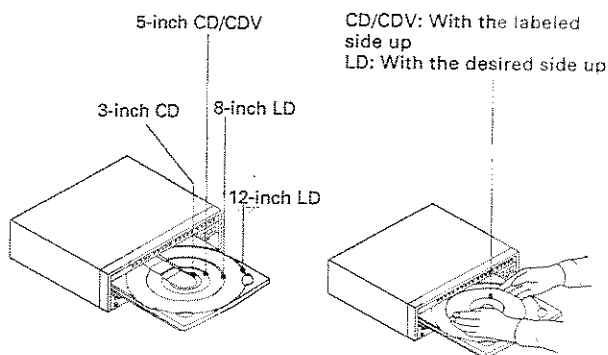

To avoid malfunctions, be especially careful about the following points.

- Do not place any object other than a disc on the disc table.
- Do not move the player while a disc is playing. This will cause the disc to be scratched.
- Be careful not to catch your finger in the disc table section while the disc table is being retracted into the unit. Also, be careful that children do not put their hands into the inside of the unit while the disc table is open. This may cause injury.

Precautions concerning disc loading

- Do not place more than one disc on the disc table. If two discs are placed one on top of the other on the disc table, discs may be scratched and/or malfunction may occur.
- With this unit, playback of all types of CD Video discs is carried out without the use of adapters. Therefore, do not use any type of adapter with this unit.

ENJOYING LASER/CD KARAOKE - BASIC OPERATION

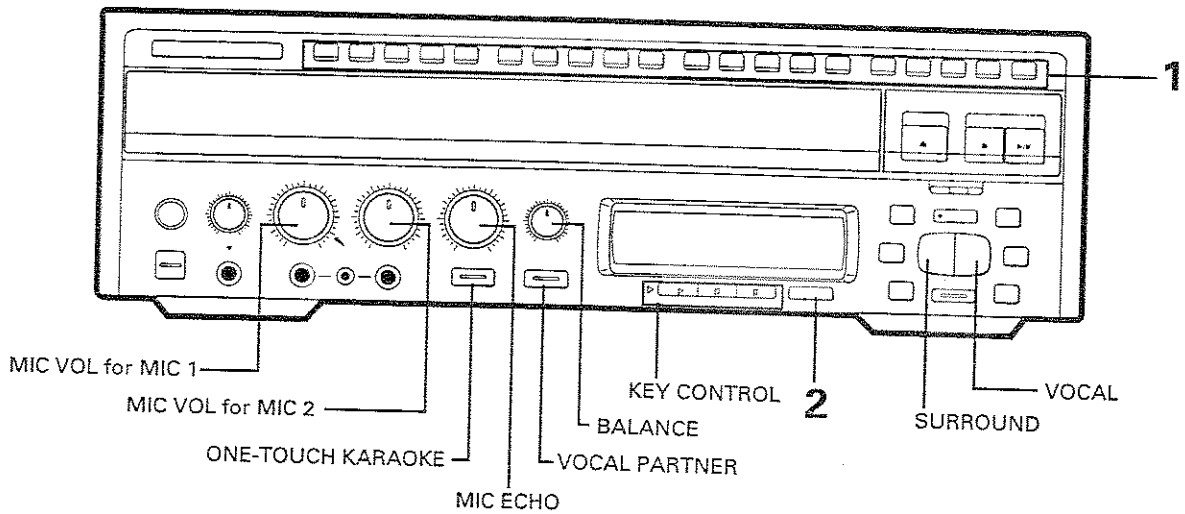

1

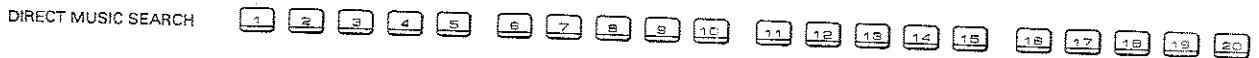

Select a song using the DIRECT MUSIC SEARCH buttons. (After one song is finished, select the next song using the DIRECT MUSIC SEARCH buttons.)

One-Song Pause Function:

Playback automatically pauses after one song is played. Select the next song using the DIRECT MUSIC SEARCH buttons. This function can operate only in KARAOKE mode.

To cut out the original vocals so that only the musical accompaniment is heard:

Press ONE-TOUCH KARAOKE so that the indicator lights.

To practice singing while listening to the original vocals (Except for general CDs, CDVs or LDs):

Press ONE-TOUCH KARAOKE so that the indicator goes out, then set the BALANCE control to the VOCAL side.

To use the VOCAL PARTNER function (Except for general CDs, CDVs or LDs):



1. Turn the BALANCE control to the VOCAL side.
 2. Press VOCAL PARTNER so that the indicator lights.
- When you sing into the microphone, your voice replaces the original vocals on the disc. This function is useful when practicing duets.

To change the musical pitch:

Use the KEY CONTROL buttons to set the desired pitch. Pressing \triangleright lowers the pitch and pressing $\#$ heightenes the pitch.

Pressing \square returns the pitch to normal.

When using the key control buttons on the microphone, press the button until the musical pitch changes.

- Set the MIC VOL control(s), SURROUND and VOCAL to the desired positions. For echo adjustment, see page 22.
- Hi-Fi stereo multiplexed sound is possible when using a karaoke disc which bears  or .

2

(Except for LDs with analog audio only)

When using multi audio karaoke discs with digital audio:

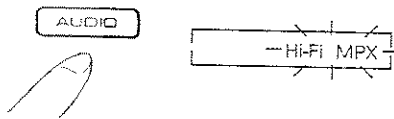

Press AUDIO so that the Hi-Fi MPX indicator lights on the display window.

- Set the BALANCE control to the MUSIC side.

When using sound multiplexed CD karaoke discs:

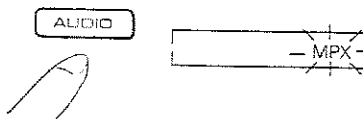

Press AUDIO so that the MPX indicator lights on the display window.



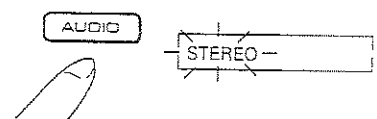

- Set the BALANCE control to the MUSIC side.

When using general CDs, CDVs or LDs (with vocal) as karaoke discs:



Press AUDIO so that the STEREO indicator lights on the display window. The BALANCE control does not function in this mode.

To stop karaoke play:

1. Press OPEN/CLOSE  or EJECT .
2. Remove the disc.
 - Always be sure to remove the disc from the player when you are finished. Place the disc back in its jacket or case and store the disc in a vertical position.
3. Press OPEN/CLOSE  or PLAY/SEARCH  to close the disc table.
 - Always be sure to close the disc table after you remove or load a disc.
4. Press POWER to turn off the power.
5. Turn off and unplug the microphone(s).
 - When using a microphone equipped with a control-use miniplug, first unplug the miniplug and then unplug the main plug.

Displays in KARAOKE mode

Lights - Flashes	Function
Karaoke	Karaoke mode
Hi-Fi MPX	Hi-Fi multiplexed
MPX	Multiplexed

Displays except for KARAOKE mode

Lights - Flashes	Function
Normal	Normal mode
AUX	Auxiliary input mode

CONVENIENT FUNCTIONS FOR KARAOKE PLAY - "MOOD UP" FUNCTIONS

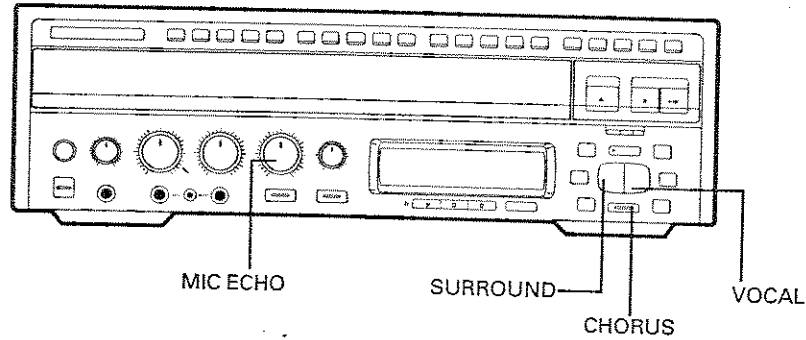

To adjust the microphone echo level

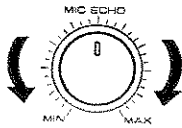

Echo is increased by turning the control to the right and decreased by turning the control to the left.

To create a live atmosphere (Surround function)

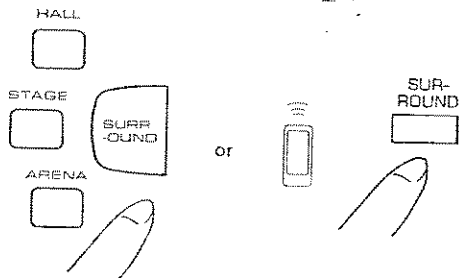

Press the SURROUND button, then select HALL, STAGE or ARENA to create the desired atmosphere.

HALL: Creates an atmosphere of singing in a concert hall. Echo and reverberation sounds are relatively long.

STAGE: Creates an atmosphere of singing on an indoor stage. Direct sounds are emphasized and reverberation sounds are suppressed.

ARENA: Creates an atmosphere of singing on an outdoor stage. Reverberation sounds are small and echoes are long.

To match the atmosphere to the music genre (Vocal effect function)

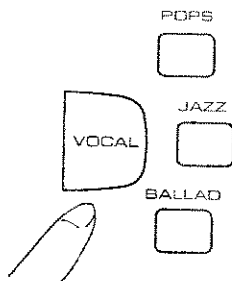

Press the VOCAL button, then select POPS, JAZZ, or BALLAD to create the desired vocal effect.

POPS: This mode is best for crisp, energetic vocals. High frequencies are emphasized and echoes are short.

JAZZ: Set this mode for deliberate, unhurried vocals. Low frequencies are emphasized and echoes are long.

BALLAD: This mode is best for soft, gentle vocals. Echoes are subdued with short delay times.

To create a chorus effect (Chorus function)

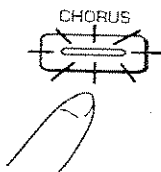

Press the CHORUS button.

High vocal sounds of 1/8 pitch and 1/4 pitch are added to the original vocals, creating the effect of two or three people singing.

CONVENIENT FUNCTIONS FOR KARAOKE PLAY - FOR PRACTICING

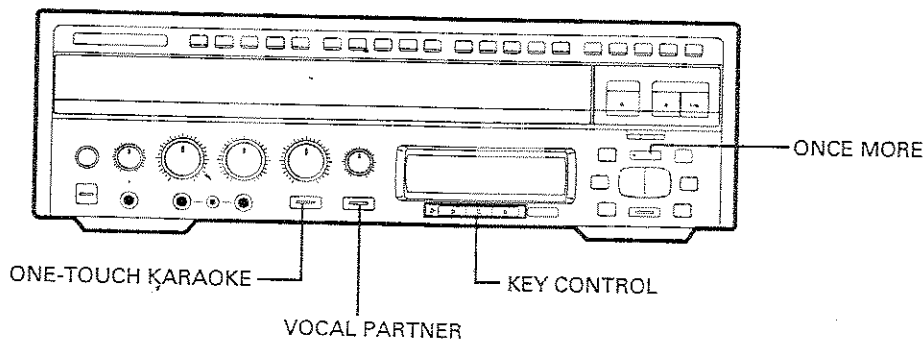

To change to karaoke play at the touch of button

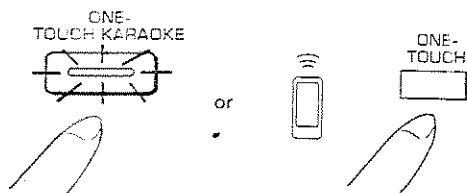

You can use this function to change to karaoke play even with general stereo discs. With some discs, however, the singer's voice may remain audible.

To use the "Vocal Partner" function so that the original vocals are replaced with your voice when you sing

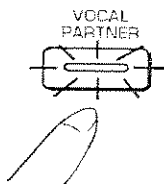

For Example:
With duets, you can sing only the male (female) part and let the original vocals sing the female (male) part. This is convenient for practicing only the male (female) part.

To set a desired pitch

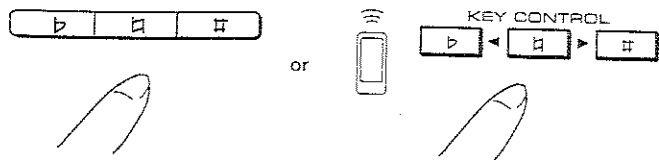

- # : Pitch is heightened each time this button is pressed (up to 4 steps).
- : Pitch returns to normal.
- b : Pitch is lowered each time this button is pressed (up to 4 steps).
- The current pitch position is shown by the lit indicator.

To repeat a section to correct a singing mistake



- Each time ONCE MORE is pressed, playback returns to a point approximately 5 seconds earlier in the song. If you press ONCE MORE several times, playback will return to a point earlier in the song equivalent to the number of presses x 5 seconds. However, the position will not return to a point earlier than the beginning of the selected song.
- If you press ONCE MORE while the player is in pause mode, playback will resume. (Once more start function)
 - If you use a microphone equipped with a ONCE MORE button, you can carry out the Once more and Once more start functions from the microphone.
 - The indicator on the ONCE MORE button blinks while the player is searching for the return point.

CONVENIENT FUNCTIONS FOR KARAOKE PLAY - FOR PRACTICING

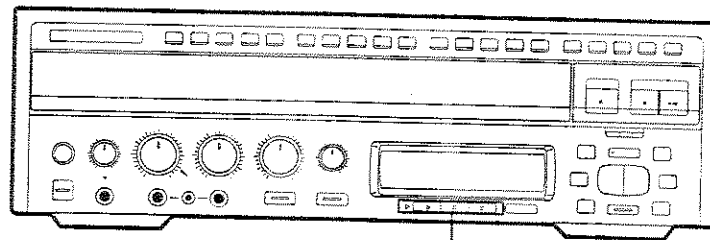

KEY CONTROL/MAGIC VOICE buttons

To use the MAGIC VOICE effects for the microphone audio

1

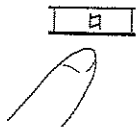

Press the  KEY CONTROL/MAGIC VOICE button for approximately 1 second.



LOW ————  ———— HIGH

The center KEY CONTROL/MAGIC VOICE indicator starts blinking on the display window.

2

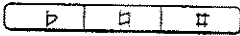

While this indicator is blinking, you can heighten or lower the pitch of the microphone audio. (Magic voice function)
To cancel MAGIC VOICE, press  again.

- While using MAGIC VOICE, the Key control function cannot be used to change the pitch of the disc audio.

Automatic discrimination of disc type when playing various types of discs:

- CD, CDV, AUX INPUT audio
You can use the AUDIO button to select either stereo or multiplex.
- LD (analog audio discs)
The player automatically determines whether the disc is multiplex or stereo.
- LDD (discs which contain both digital and analog audio)

Discs which bear the mark:

Multiplex has priority. The AUDIO button can be used to switch the audio only with discs in which the digital and analog audio parts are different.

Discs without the mark:

The analog audio part is automatically identified. However, discrimination between stereo and multiplex for the digital audio part is not possible; the digital audio part is regarded as stereo and the AUDIO button functions only with discs in which the analog part is multiplex.

ADDITIONAL FUNCTIONS POSSIBLE WITH OTHER KARAOKE DEVICES

Connection

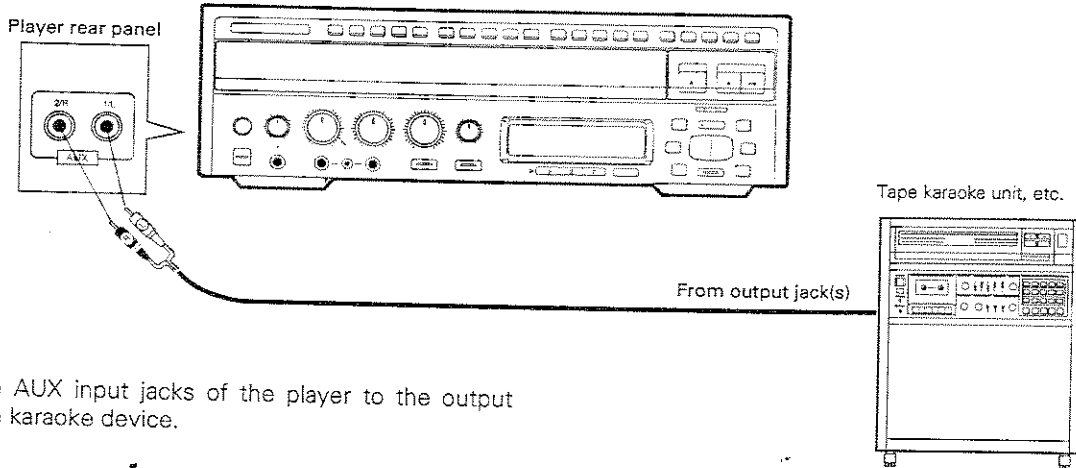

Connect the AUX input jacks of the player to the output jack(s) of the karaoke device.

Operation

- 1 Turn on the power.
- 2 Set the KARAOKE/NORMAL/AUX INPUT switch to AUX INPUT.

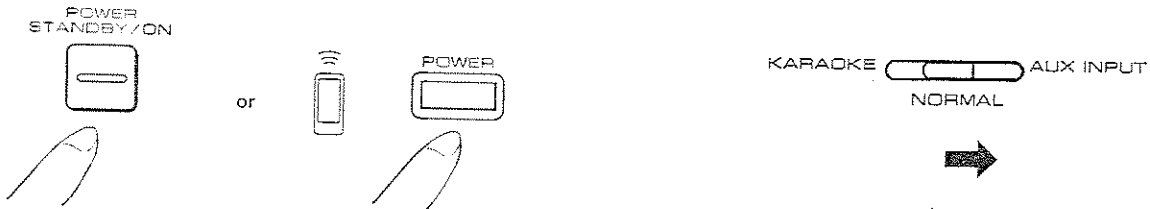

- 3 Select the audio mode that corresponds to the auxiliary device.
 - Hi-Fi MPX mode does not function in AUX INPUT mode. Also, this unit's One-Song Pause function will not operate even if you directly select a song.

If the auxiliary input component is a stereo device:

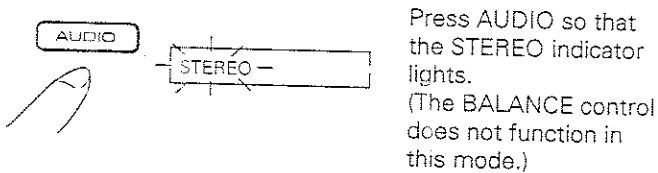

If the auxiliary input component is a sound multiplexed device:

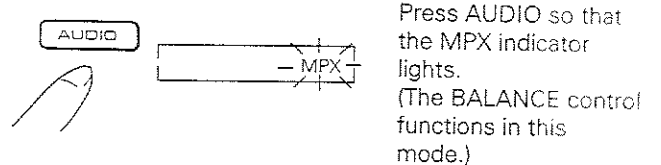

- The musical pitch of the device connected to the AUX input jacks can be changed using the KEY CONTROL buttons. Also, the Vocal Partner function and One Touch Karaoke function can be carried out.

DISPLAY SWITCHING

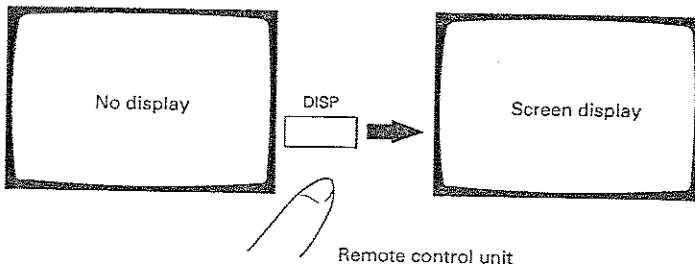

Information regarding the operations being carried out can be displayed on the screen of the monitor TV. When DISP on the remote control unit is pressed the first time, the screen is displayed.

With LD discs containing a TOC ...

Each time DISP is pressed, the display changes in the following order: time/frame number (elapsed play time/frame from the beginning of the disc) → Remain Time ALL (remaining play time of the disc) → Total Time (total play time of the disc) → display off.

- With CAV discs, the Disc time ABS (elapsed play time from the beginning of the disc) is displayed after the frame number.

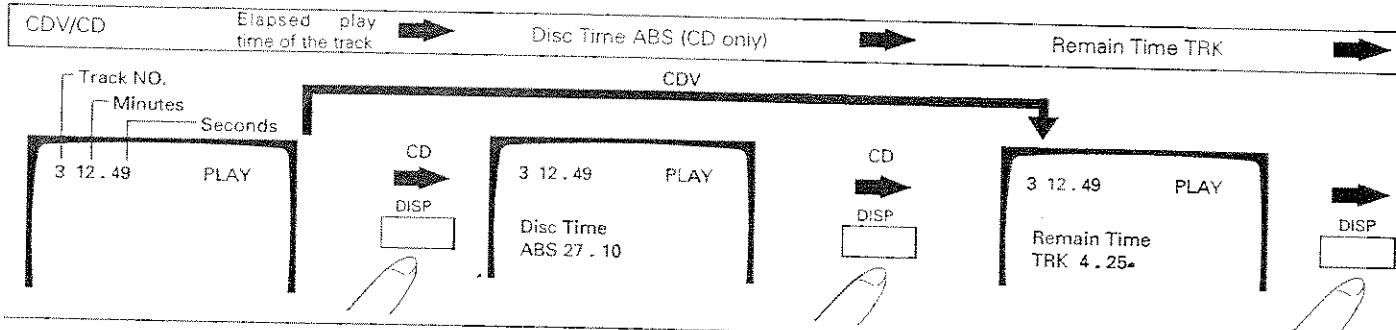
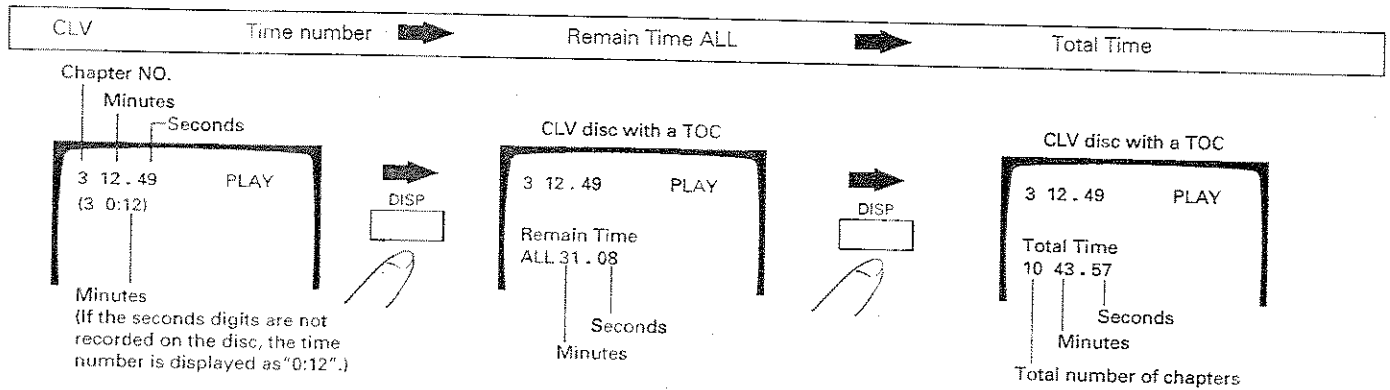

Other displays

Lights - Flashes	Function	Lights - Flashes	Function
OPEN	Opening of the table	Program	Program mode
CLOSE	Closing of the table	Step-	Chapter/Track program step
STOP	Stop mode	Digital	Digital signal setting
PLAY	Play mode	Analog	Analog signal setting
PAUSE	Pause mode	Stereo	Stereo
STILL	Frozen picture	1/L ch	Main audio/Left channel
Video	Video part search	2/R ch	Sub audio/Right channel
Audio	Audio part search	CX ON	CX noise reduction system ON
Repeat Chapter (Track)	Chapter/track repeat	CX OFF	CX noise reduction system OFF
Repeat Side -A (B)	One side repeat		
Repeat Program	Program repeat		

With LD discs having no TOC...

Each time DISP is pressed, the display changes in the following order: time/frame number → display off.

With CDV discs...

Each time DISP is pressed, the display changes in the following order: elapsed play time of the track being played → Remain Time TRK (remaining play time of the track being played) → Remain Time ALL (remaining play time of the video or audio part being played) → Total Time (total play time from the beginning of the video or audio part being played) → display off.

With CD discs ...

Each time DISP is pressed, the display changes in the following order: elapsed play time of the track being played → Disc Time ABS (elapsed play time from the beginning of the disc) → Remain Time TRK (remaining play time of the track being played) → Remain Time ALL (remaining play time of the disc) → Total Time (total play time from the beginning of the disc) → display off.

- These data are also displayed on the display window of the front panel.

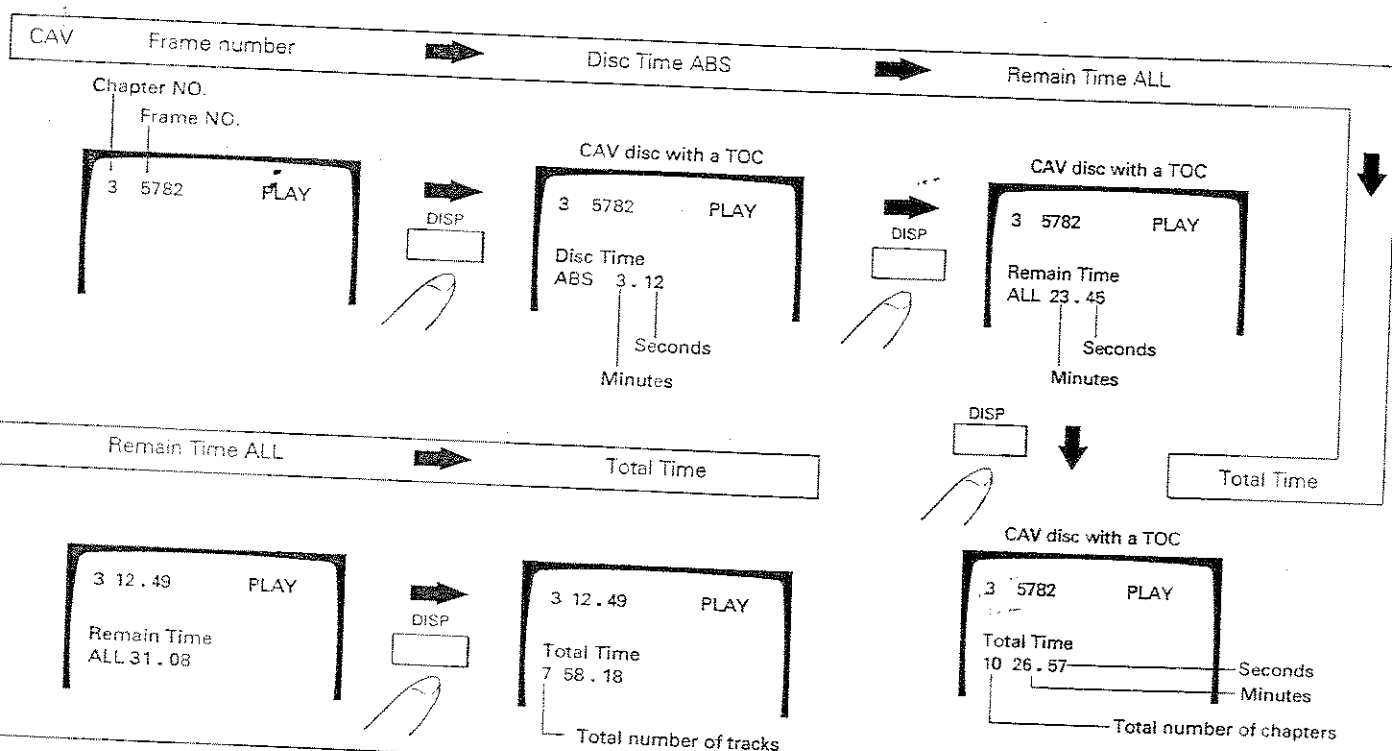

Music calendar display

On the monitor screen, you can see all of the chapter/track numbers recorded on the disc at a glance. If the disc contains more than 24 chapters/tracks, the music calendar shows the 25th and the followings after the 24th chapter/track is finished playing. The chapter/track numbers to be played are displayed in reverse color while the chapter/track numbers which have been played are displayed in normal color.

To display the music calendar

Press DISP on the remote control unit when the TOC data has been read. (After a disc is loaded, the player reads the TOC data.) With CDs or CDVs (audio part), the music calendar is immediately displayed.

With LDs (with TOC) or CDVs (video part) the music calendar is displayed during pause mode or search mode.

- Even if an LD contains chapter No. 0, the music calendar cannot display No. 0.
- With LDs without TOC, the music calendar cannot be displayed.
- The music calendar shows all of the chapter/track numbers recorded on the disc, however the TOC data (time data) of the 33th or more cannot be memorized.

Front panel buttons and remote control unit buttons with the same name or mark have the same function.

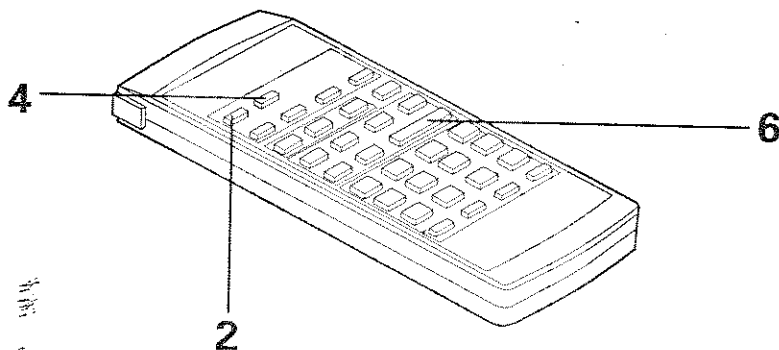

5

Load a disc.

As shown in the following diagram, place the disc on the disc table in the groove corresponding to the size of the disc.

If the disc is not centered correctly on the disc table, the disc will not be played or the disc or the player may be damaged.

Always place the disc correctly according to the required disc size on the disc table.

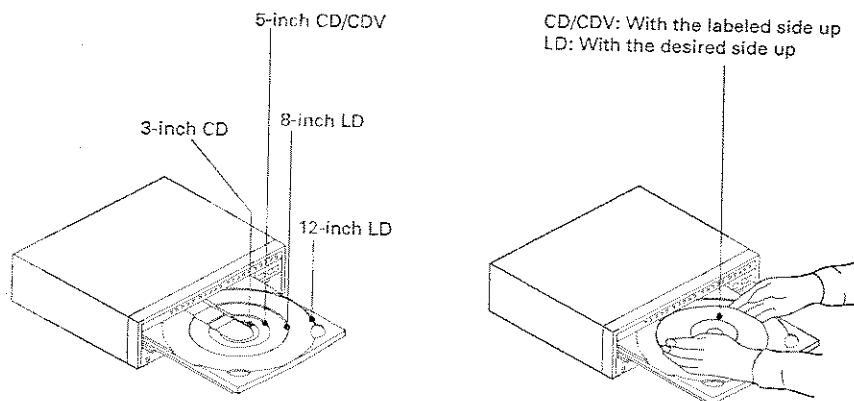

6

Start playback.

PLAY/PAUSE



Front panel

or

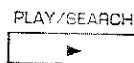

Remote control unit

- With CDV discs, the video part is played first.
- With the surround function (→ p. 22), you can select the desired atmosphere to match the disc genre, such as movie or music.

To avoid malfunctions, be especially careful about the following points.

- Do not place any object other than a disc on the disc table.
- Do not move the player while a disc is playing. This will cause the disc to be scratched.
- Be careful not to catch your finger in the disc table section while the disc table is being retracted into the unit. Also, be careful that children do not put their hands into the inside of the unit while the disc table is open. This may cause injury.

Precautions concerning disc loading

- Do not place more than one disc on the disc table. If two discs are placed one on top of the other on the disc table, discs may be scratched and/or malfunction may occur.
- With this unit, playback of all types of discs is carried out without the use of adapters. Therefore, do not use any type of adapter with this unit.

TO PLAY AN LD, CDV OR CD

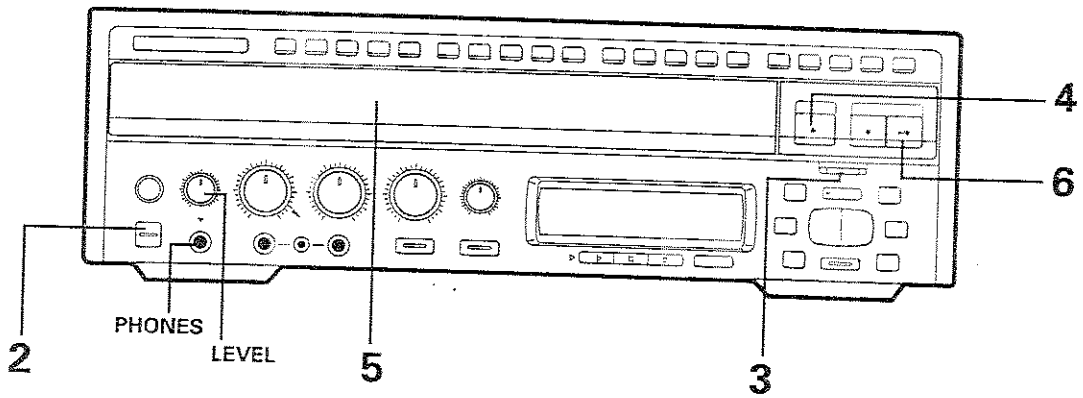

- | | | | |
|--|--|---|---|
| <p>1</p> <p>Turn on the power to the monitor TV and/or audio system.</p> <p>When a stereo system is used for audio listening:
Turn on the power of the amplifier, and set its input selector to the proper position for listening to the player, such as "CD" or "LD".</p> | <p>2</p> <p>Turn on the power to this unit.</p> <p>Front panel
or
Remote control unit</p> | <p>3</p> <p>Set KARAOKE/
NORMAL/AUX
INPUT to NORMAL.</p> | <p>4</p> <p>Open the disc table.</p> <p>Front panel
or
Remote control unit</p> |
|--|--|---|---|

State of the display window during playback:

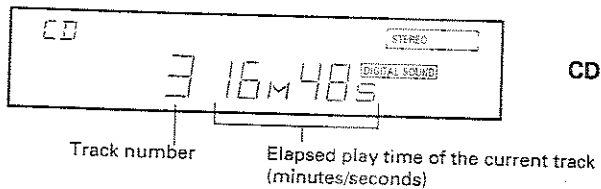
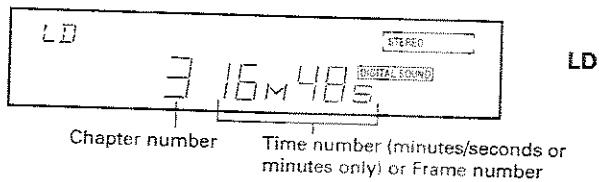

To play and listen to a disc without connecting this unit to an audio system:
Plug headphones into the PHONES jack on the front panel of this unit and adjust the volume with LEVEL.

TO PLAY AN LD, CDV OR CD (Continue)

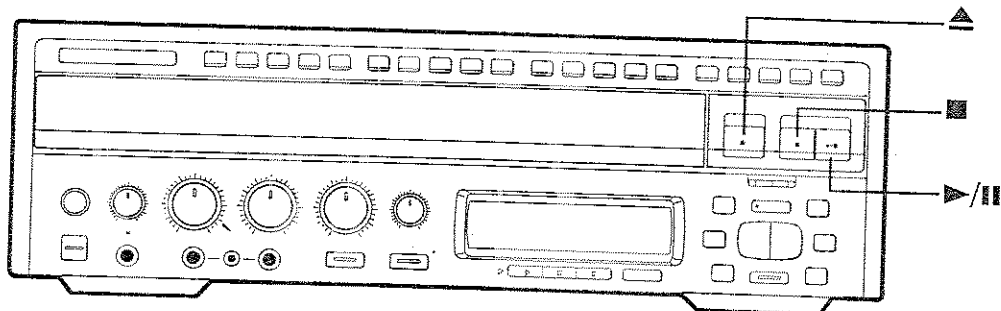

To pause playback temporarily

PLAY/PAUSE



Front panel

or

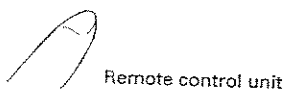

Remote control unit

The sound and/or video image disappears. Press PLAY/PAUSE ►/|| or PAUSE || again to resume playback from the position where pause mode was entered.

To stop playback

STOP



Front panel

or

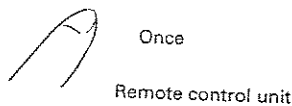

Once

Remote control unit

When PLAY/PAUSE ►/|| or PLAY/SEARCH ► is next pressed, disc playback starts again from the beginning.

To stop playback and take out the disc

OPEN/CLOSE



Front panel

or

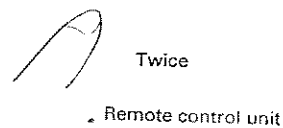



Twice

Remote control unit

After removing the disc from the disc table, press OPEN/CLOSE ▲ or PLAY/SEARCH ► to close the table.

Discs marked with the mark

Discs marked  are recorded with the CX noise reduction system for powerful audio reproduction with little noise. (Analog audio only) However, some discs marked are not encoded with the signals necessary to instruct the unit to automatically switch on the CX system. If sound is noisy or undulate when a disc with a  mark is played, press D/A/CX button on the remote control unit.

•  is a trademark of CBS inc. This player meets the CX EXPANDING SPECIFICATION.

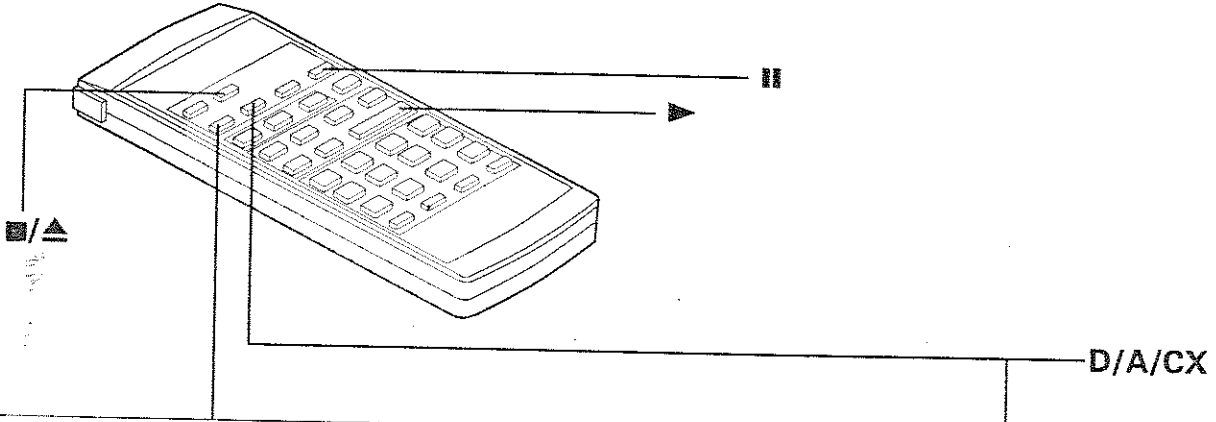

To listen to only one channel of a stereo disc, or to select the audio on a sound multiplex disc

During playback

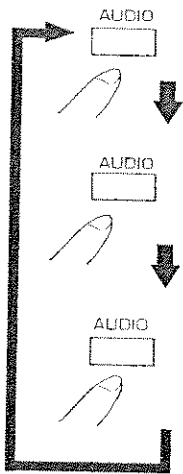

Played audio		Display on screen
Stereo disc	Sound multiplex disc	
Stereo	Audio 1/L (Left) Audio 2/R (Right)	
Left	Audio 1/L (Left)	1/L ch
Right	Audio 2/R (Right)	2/R ch
Return to start		Stereo

To listen to the analog audio of an LD digital audio disc:

During playback

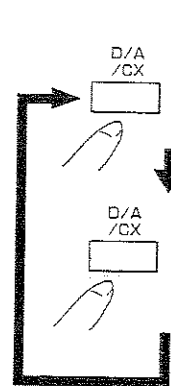

Played audio	DIGITAL SOUND indicator
Digital	Lights
Analog	Goes off
Return to start	

With a Multi Audio disc (an LD bearing the "MULTIAUDIO" mark), you can listen to the various audio tracks recorded on the disc by using D/A/CX to select between the analog and digital audio tracks, and by using AUDIO to select between the left (1/L) and right (2/R) channels.

Examples of the various types of audio recorded on Multi Audio discs

Disc	Audio	Analog audio	Digital audio
Movies, animations, etc.		Audio of the main program	Soundtrack
Dual music		Music 1	Music 2
Various types of digital audio karaoke		1/L Karaoke (monaural) 2/R Assisting vocals	Stereo karaoke
Stereo bilingual		Native language	Foreign language 1

Disc	Audio	Analog audio	Digital audio
Trilingual		Native language	1/L Foreign language 1 2/R Foreign language 2
Quadlingual		1/L Native language 2/R Foreign language 1	1/L Foreign language 2 2/R Foreign language 3

EXTRA PLAYBACK

Still frame and Frame-by-Frame advance function



Press either of these buttons.

During playback if STEP on the remote control unit is pressed, the picture will be frozen. At this point, the disc can be played one frame at a time in either the forward or reverse direction by pressing one of these buttons. The sound is muted during still frame or frame advance operation.

To return to normal playback operation, press ►.

TO SEARCH FOR A PARTICULAR PASSAGE

Manual Search

Manual Search – Search using fast forward or fast reverse

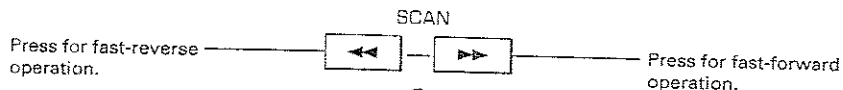

Press for fast-reverse operation.



Press for fast-forward operation.

Normally Clear Scan is performed. To perform Low Scan and High Scan, press DISP on the remote control unit to display the screen and then press SCAN button. For about two seconds after the button is pressed, Low Scan is performed, after that, the unit enters High Scan.

Clear Scan mode: The image may not be fluctuated in this mode.

Low Scan mode: Scan speed becomes about x10 the normal playback speed.

High Scan mode: Scan speed becomes about x30 the normal playback speed.

- With CDs or audio part of CDVs, Clear Scan mode cannot be carried out.
- With video part of CDV, High Scan mode cannot be carried out.

- In Clear Scan mode, when digital sound is selected with digital audio discs, sound is heard at low volume level. In karaoke mode, sound is muted.
- With CDs or audio part of CDVs, sound is heard at low volume level while scanning
- Others: Sound is muted.

Notes on CAV:

While scanning, noise may occur on the screen. This is not a malfunction.

Notes on CLV:

- While scanning, the color of the image may fade out or the image sometimes fluctuates.
- The scan speed is different between inner tracks and outer tracks.

TO SEARCH FOR A PARTICULAR CHAPTER/TRACK

Chapter (Track) Search/Chapter (Track) Skip

The term "chapter" refers to each section on an LD, and the term "track" refers to each section on a CD or CDV disc. If chapter or track numbers are encoded on a disc, it is so indicated on the disc jacket.

- Chapter Search is not possible with discs which are not divided into chapters.

Chapter (Track) Search – To search by designating the chapter/track number

Example:

To play from the beginning of Chapter/Track 3:

<Direct Search>

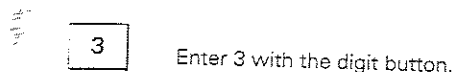

<Normal Search>

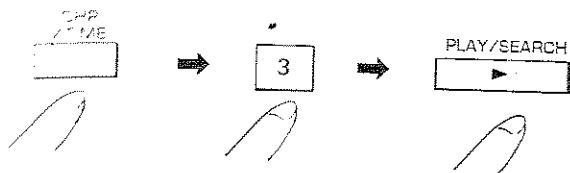

After the display shows Frame No. or Time No. press this button again.

Enter 3 with the digit button.

To search for chapter or track number 10 or above:

Use **+10** button.

(Example)

To enter 17: **+10**, **7**

To enter 30: **+10**, **+10**, **+10**, **0**

If you make a mistake in pressing the digit buttons: Press CLEAR, and then press the correct button.

To identify the present chapter number and frame (or time) number:

The numbers are displayed in the front panel display window. The information can also be displayed on the monitor TV screen by pressing DISP on the remote control unit.

Chapter (Track) Skip – To search for the beginning of a chapter/track

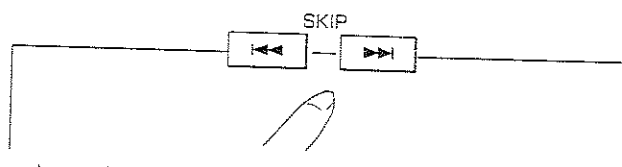

Press once to return the playback position to the beginning of the chapter/track being played. If the button is pressed more than once before the picture reappears, the beginning of a chapter/track located before the chapter/track being played is searched for and played. The position of the located track corresponds to the number of times the button is pressed.

If this button is pressed once or a number of times, playback is advanced to the beginning of a chapter/track located after the chapter/track being played. The position of the located track corresponds to the number of times the button is pressed.

To cancel the search operation

Press CLEAR while the player is searching for the chapter or track.

TO SEARCH FOR A PARTICULAR TIME/FRAME

Time Number Search/Track time Search/ABS Time Search/Frame Number Search

Time Number Search – Example: To search for the scene located at time number 12 min. 34 sec (CLV)

1. **Press CHP/TIME.**
When the display shows chapter No., press this button again.
2. **Enter 1, 2, 3 and 4 with the digit buttons.**
If you make a mistake during entry:
Press CLEAR to reset the time number to "0.00", and press the correct digit buttons again.
3. **Press ► or ►/II.**

CAUTION

If a disc does not contain information on the digits of seconds, specify the time number only as far as the minute digits.

Track Time Search – To search for a time on a specified track (CD/CDV)

1. **Press CHP/TIME.**
2. **Press SKIP ◀◀ or ▶▶** so that the desired track number appears in the front panel display window.
3. **Enter the track time (elapsed time from the beginning of the specified track) with the digit buttons (0 - 9).**
4. **Press ► or ►/II.**

ABS Time Search (CD only) – To search for a point by designating the elapsed time from the beginning of the disc

1. **Press CHP/TIME** so that "Ab" appears in the front panel display window. (On the monitor screen, "ABS" appears.)
2. **Enter the elapsed time from the beginning of the disc with the digit buttons (0-9).**
3. **Press ► or ►/II.** Playback starts from the specified elapsed time.

Frame Number Search (CAV discs only) – To search by designating the frame number

Any desired frame can be searched for by specifying its frame number.

1. **Press CHP/TIME.** When the display shows chapter NO., press this button again. "Frame 0" is displayed.
2. **Enter the required frame number with the digit buttons (0 - 9).**
3. **Press ► or ►/II.** The designated frame is played as a still frame.

NOTES:

- The +10 button does not function.
- If you make a mistake in pressing the digit buttons, press CLEAR and press the correct digit buttons.

To exit search mode:
Press CLEAR.

TO REPEATEDLY PLAY A DESIRED PASSAGE – Repeat Playback

Chapter/Track Repeat – To repeat the current chapter or track

REPEAT



Press REPEAT on the remote control unit while the chapter/track to be repeated is playing.

When the end of the chapter/track is reached, the player returns to the beginning of the chapter/track and the chapter/track is played back repeatedly.

When the player returns to the beginning of the chapter/track, "Repeat Chapter (Track)" appears on the monitor screen.

One Side Repeat – To repeat an entire side of a disc

REPEAT



Press REPEAT twice.
"Repeat Side-A (B)" appears on the monitor screen.

When playback reaches the end of the playback side, the player returns to the beginning of the disc and the same side is played back repeatedly.

With CDV discs, when playback reaches the end of the audio part, the player returns to the beginning of the video part and the whole disc is played back repeatedly.

Program Repeat – To repeat a program

With the program repeat function, you can repeatedly play programmed chapters or tracks in their programmed order.

- See page 36 for details on programming.

REPEAT



Press REPEAT while the program is being played. "Repeat Program" appears on the monitor screen.

To exit repeat mode:

Press CLEAR on the remote control unit. Repeat mode is canceled and playback continues from the current point.

Discs which have no chapter numbers:

Chapter repeat cannot be carried out. With such discs, playback can be carried out in One Side repeat mode by pressing REPEAT.

To display repeat mode on the monitor screen:

Press DISP on the remote control unit.

TO PLAY ONLY THE DESIRED SCENES/TRACKS – Program Playback

Selected chapters (LD) or tracks (CDV/CD) can be played in any desired order (max. 24 chapters or tracks).

- You can view the state of programming on the monitor TV screen.

Example To play CD tracks No. 9, No. 7, and No. 18 in this order:

1 Press PGM.

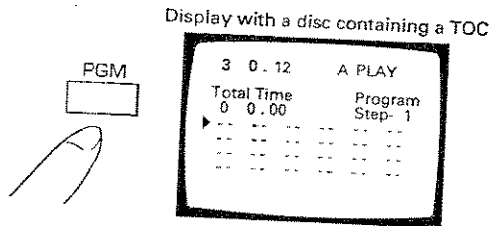

2 Enter 9, 7, +10, and 8 with the digit buttons.

If you make a mistake during entry: Press CLEAR and enter the correct number with the digit buttons.

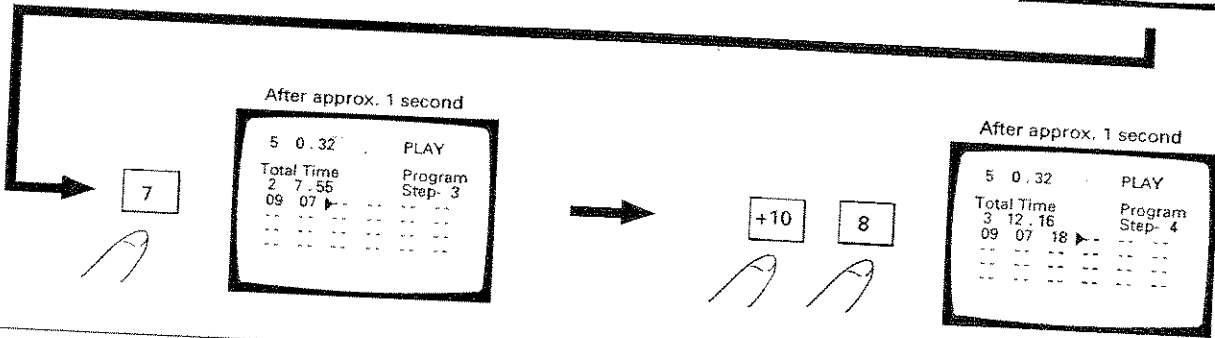
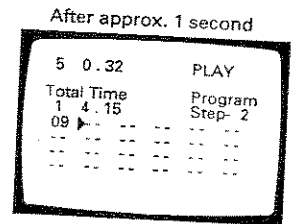

3 Press PLAY/SEARCH ▶.

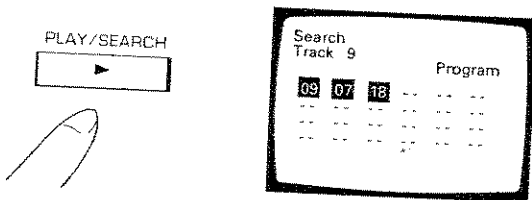

The first track (chapter) in the program is searched for and played. In this example, Program Playback starts at the beginning of track number 9. After tracks No. 9, No. 7, and No. 18 have been played, the player enters stop mode.

To stop program play in the middle:

- Press STOP ■ on the front panel of the player or EJECT ■/▲ on the remote control unit.
- Press CLEAR on the remote control unit.

To clear the program contents:

- Open the disc table.
- Press CLEAR on the remote control unit in stop mode.

Programming a pause:

When recording on a cassette tape, a programmed pause allows you to change the tape side or to record a blank section on the tape which is useful for music search functions, etc. When a program is in pause mode, pressing PAUSE ■ resumes disc playback, so restart recording before pressing PAUSE ■.

To program a pause:

In step 2 of the above procedure, press PAUSE ■ instead of entering a chapter or track number.

NOTE:

- A pause cannot be programmed for step 1, and it cannot be programmed for two consecutive steps.
- A pause can be programmed for the last program step, however, it will not be effective.

Programmed pause indication:

"■" is displayed on the monitor screen.

To go to the previous or next chapter (track) in a program:

Press SKIP ◀◀ or ▶▶ on the remote control unit.

Total time display (CD and CDV only):

When programming for CD or CDV, the total time of the programmed tracks is displayed. If the total time exceeds 100 minutes, 100's digit will not be displayed in the display window of the front panel.

- If track No. 33 or more is programmed, the total time will not be displayed.

To check the program contents

During program playback or in stop mode, press PGM to display the program contents on the monitor screen. When PGM is pressed again, the program contents disappear.

To modify the program contents**To erase a programmed chapter/track or pause**

1. Press PGM.
2. Press SKIP ◀◀ or ▶▶ to place the cursor (▶) on the left side of the chapter/track or pause to be erased.
3. Press CLEAR.
4. Press PGM to complete programming. Pressing ▶ also completes programming and starts program playback with the new program contents.

To change a programmed chapter/track or pause to a new one

1. Press PGM.
 2. Press SKIP ◀◀ or ▶▶ to place the cursor (▶) on the left side of the chapter/track or pause to be changed.
 3. Enter the new chapter/track number with the digit buttons.
Press PAUSE || to enter a pause.
 4. Press PGM to complete programming. Pressing ▶ also completes programming and starts program playback with the new program contents.
- Programmed chapter/track being played cannot be erased or changed.
 - Programmed pause being engaged cannot be erased or changed.

CAUTION

- If SCAN ▶▶ is held depressed during Program Playback, the playback position will move to another chapter/track, but when ▶▶ is released, the next chapter/track in the program will be played. If ◀◀ is held depressed, the playback position returns to the beginning of the current chapter or track being played, but it will not go beyond it to a previous chapter or track in the program.

TROUBLESHOOTING

Incorrect operations often cause troubles and malfunctions. If you think that there is something wrong with this component, check the points below. Sometimes the trouble may lie in another component. Inspect the other components and electrical appliances being used. If the trouble cannot be rectified even after exercising the checks listed below, ask your nearest PIONEER authorized service center or your dealer to carry out repair work.

SYMPTOM	CAUSE	REMEDY
1. Disc table is not ejected when OPEN/CLOSE is pressed.	<ul style="list-style-type: none"> ● Power cord is not properly plugged into AC wall socket. ● Power switch is not turned on. 	<ul style="list-style-type: none"> ● Plug in power cord. ● Turn on power switch.
2. Disc table comes out.	<ul style="list-style-type: none"> ● Disc is dirty. ● The disc is not properly set on the disc table. ● Moisture has condensed on parts in the player. ● Disc is warped. 	<ul style="list-style-type: none"> ● Clean disc. ● Set the disc properly. ● Remove disc and let player stand for 1 to 2 hours until it is dry. ● Try to alleviate the warp. (Refer to Symptom 19, remedy column.)
3. Remote control does not work.	<ul style="list-style-type: none"> ● The CONTROL IN terminal on the rear panel is connected to pioneer projection monitor or AV control center. ● Batteries are weak. ● There is an obstacle between the player and the remote control unit. ● Remote control unit is not in a good location for transmission. 	<ul style="list-style-type: none"> ● Aim the remote control unit at the projection monitor or AV control center. ● Replace batteries. ● Remove the obstacle or shift the remote control position. ● Operate the remote control unit in front of the player.
4. Operation of the remote control unit causes the TV to operate improperly.	<ul style="list-style-type: none"> ● Some TV sets have remote control functions that operate improperly in response to the remote control unit of the player. 	<ul style="list-style-type: none"> ● Move the TV and the player further apart, or cover the remote sensor of the TV during disc playback.

TROUBLESHOOTING

WHEN PLAYING KARAOKE

For karaoke play, always set the KARAOKE/NORMAL/AUX INPUT selector to the KARAOKE position.

SYMPTOM	CAUSE	REMEDY
5. The One-Song Pause function or other KARAOKE functions cannot be operated.	<ul style="list-style-type: none"> The KARAOKE/NORMAL/AUX INPUT selector is set to the NORMAL position. 	<ul style="list-style-type: none"> Set it to the KARAOKE position.
6. No sound.	<ul style="list-style-type: none"> The KARAOKE/NORMAL/AUX INPUT selector is set to the AUX INPUT position. 	<ul style="list-style-type: none"> Set it to the KARAOKE position.
7. The BALANCE control does not function.	<ul style="list-style-type: none"> The KARAOKE/NORMAL/AUX INPUT selector is set to the NORMAL position. The AUDIO button is set to the STEREO position when playing a sound multiplexed CD or CDV karaoke disc. 	<ul style="list-style-type: none"> Set it to the KARAOKE position. Set the AUDIO button so that the STEREO indicator goes out.
8. Hi-Fi stereo multiplexed sound is not possible.	<ul style="list-style-type: none"> The KARAOKE/NORMAL/AUX INPUT selector is set to the NORMAL position. The Hi-Fi stereo multiplexed sound disc is not used. 	<ul style="list-style-type: none"> Set it to the KARAOKE position. Use a karaoke disc which bears Digital MULTI AUDIO or digital MULTI AUDIO.
9. The volume level of the original vocal is not reduced even when ONE-TOUCH KARAOKE is pressed.	<ul style="list-style-type: none"> The AUDIO button is not set to the appropriate audio mode with a CD or auxiliary device. 	<ul style="list-style-type: none"> Set it to the appropriate mode.
10. The original vocals are not replaced with the singing voice even when VOCAL PARTNER is pressed.	<ul style="list-style-type: none"> The volume level of the microphone is too low. The singing voice level is too small. The AUDIO button is not set to the appropriate audio mode with a CD or auxiliary device. 	<ul style="list-style-type: none"> Raise the volume level. Sing louder. Set it to the appropriate mode.
11. The \triangleright or \square button cannot be operated.	<ul style="list-style-type: none"> The player is in magic voice mode and the center KEY CONTROL/MAGIC VOICE indicator is blinking. 	<ul style="list-style-type: none"> Cancel the magic voice mode by pressing the \square button.
12. The Once more operation or Key control operation cannot be carried out with the Pioneer Microphone DM-V161.	<ul style="list-style-type: none"> The microphone control jack (\sphericalangle MC) is not connected. The microphone is not turned on. 	<ul style="list-style-type: none"> Connect it. Turn on the microphone.
13. Nothing changes when the ONE-TOUCH KARAOKE button is pressed.	<ul style="list-style-type: none"> When playing back sound multiplexed discs, the BALANCE control is set to the MUSIC side. 	<ul style="list-style-type: none"> Set it to the VOCAL side.
14. Some songs cannot be selected with DIRECT MUSIC SEARCHs.	<ul style="list-style-type: none"> The selected number does not exist on the disc. 	<ul style="list-style-type: none"> Select the song which exists on the disc.
15. The original vocals cannot be heard with a sound multiplexed Laser Karaoke disc.	<ul style="list-style-type: none"> The ONE-TOUCH KARAOKE button is turned on. The BALANCE control is set to the MUSIC side. 	<ul style="list-style-type: none"> Turn ONE-TOUCH KARAOKE off. Set it to the VOCAL side.
16. The next song starts playback after one song is finished.	<ul style="list-style-type: none"> When playback is started with PLAY/PAUSE (or PLAY) or resumed with PLAY/PAUSE (or PAUSE), the player is always in playback mode even when one song is finished. 	<ul style="list-style-type: none"> Select the song with DIRECT MUSIC SEARCH.

TROUBLESHOOTING

WHEN A LASERVISION DISC IS BEING PLAYED

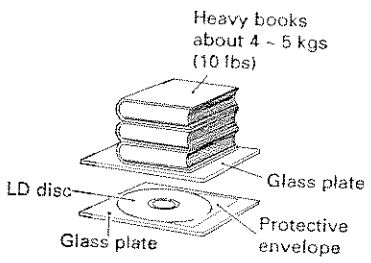
SYMPTOM	CAUSE	REMEDY
17. Disc is rotating but there is no picture.	<ul style="list-style-type: none"> ● The TV set is not turned on. ● Wrong connections from player to TV. 	<ul style="list-style-type: none"> ● Turn on TV. ● Make correct connections.
18. Picture continuously moves vertically.	<ul style="list-style-type: none"> ● The TV vertical hold control is not adjusted properly. 	<ul style="list-style-type: none"> ● Adjust vertical-hold control on TV.
19. Particular disc does not playback properly. The playback stops in the middle of the disc program.	<ul style="list-style-type: none"> ● The playing surface of the disc is dirty. ● The disc is warped. 	<ul style="list-style-type: none"> ● Use a soft cloth and lightly wipe off the dirt from the surface of the disc. If necessary, moisten a cloth with diluted neutral detergent to remove heavy dirt or fingerprints. ● LD discs only Put the disc into the protective envelope, then place it on a flat desk top. Subsequently, place a flat board e.g. glass plate on the disc, and load it with about 4 – 5 kgs (about 10 lbs). If it is left in this state for one day, sometimes the warp will be alleviated. <div style="text-align: center; margin-top: 10px;">  <p style="font-size: small; margin: 0;">Heavy books about 4 ~ 5 kgs (10 lbs)</p> <p style="font-size: small; margin: 0;">Glass plate</p> <p style="font-size: small; margin: 0;">LD disc</p> <p style="font-size: small; margin: 0;">Glass plate</p> <p style="font-size: small; margin: 0;">Protective envelope</p> </div>
20. Sound is unnatural or distorted.	<ul style="list-style-type: none"> ● CX system is turned ON for disc which has no mark. 	<ul style="list-style-type: none"> ● Press D/A/CX to turn CX system OFF.
21. No sound output during playback.	<ul style="list-style-type: none"> ● STILL/STEP playback is being performed. Sound is output only during the normal play mode. The audio signals are not output during other playback modes. 	<ul style="list-style-type: none"> ● Press PLAY/SEARCH or PLAY/PAUSE to set the player to normal play mode.
22. During STILL playback, a part of the screen image shakes.	<hr style="width: 50%; margin: 0 auto;"/>	<ul style="list-style-type: none"> ● Even if the disc is a standard play disc, there may be some cases in which a fully still image cannot be obtained, but this does not mean that the player or the disc is defective.
23. CHAPTER SKIP, CHAPTER PROGRAM PLAY and CHAPTER NUMBER SEARCH cannot be performed.	<ul style="list-style-type: none"> ● Disc in which no chapter numbers are recorded is loaded. 	<ul style="list-style-type: none"> ● Press DISP to check if chapter number is displayed.
24. Certain discs take too long to search for or do not search for.	<ul style="list-style-type: none"> ● It takes time to read the recorded code, depending on the disc. 	<ul style="list-style-type: none"> ● Press CLEAR and picture will appear. (At this point, a slightly different scene from that which has been searched for may appear.)

TROUBLESHOOTING

SYMPTOM	CAUSE	REMEDY
25. Certain discs take too long to start or do not start.	<ul style="list-style-type: none"> There are errors when the disc code is read (There is no damage to the unit). 	<ul style="list-style-type: none"> Press STOP and stop the playback. Press the PLAY/SEARCH or PLAY/PAUSE and start the playback again. (Repeat this operation a few times.)
26. Picture other than instructed is searched in TIME NUMBER SEARCH mode.	<ul style="list-style-type: none"> Method of inputting numerals in the TIME NUMBER SEARCH mode differs, depending on whether time number is recorded on disc in hours and minutes or minutes and seconds, as shown below: [e.g.] 12-minute search Disc in which time number is recorded in hours and minutes <div style="text-align: center; margin: 10px 0;"> </div> <ul style="list-style-type: none"> Disc in which time number is recorded in minutes and seconds <div style="text-align: center; margin: 10px 0;"> </div>	

WHEN PLAYING BACK A COMPACT DISC

SYMPTOM	CAUSE	REMEDY
27. Player stops immediately after playback is started.	<ul style="list-style-type: none"> Disc is loaded upside down (CD, CDV, one sided LD discs). The playing surface of the discs is dirty. Disc is not properly set on the disc table. 	<ul style="list-style-type: none"> Load the disc correctly with the label side upward. Use a soft cloth and lightly wipe off the dirt from the surface of the disc. If necessary, moisten a cloth with diluted neutral detergent to remove heavy dirt or fingerprint. Set the disc properly.
28. No sound output	<ul style="list-style-type: none"> The stereo amplifier is not correctly connected. You are not operating the stereo amplifier correctly. The connection terminals and/or the plugs of the connection cords are dirty. The plugs of the connection cords are disconnected, or are not fully pushed in. The player is in pause mode. 	<ul style="list-style-type: none"> Connect the amplifier correctly. Refer to the operating instructions for the amplifier, and operate the amplifier correctly. Clean the plugs and terminals and connect again. Make sure that connections are made correctly. Press PLAY/PAUSE and restore the player to play mode
29. Sound is distorted.	<ul style="list-style-type: none"> The audio output jacks are connected to the PHONO jacks. The connection terminals and/or the plugs of the connection cords are dirty. The plugs of the connection cords are not fully pushed in. 	<ul style="list-style-type: none"> Connect to the AUX, CD, VDP or LD jacks. Clean the plugs and terminals and connect again. Push the plug in firmly.

Abnormal functioning of this unit may be caused by lightning, static electricity, or other external interference. To restore normal operation, turn the power off and then on again, or unplug the AC power cord and then plug it in again.

SPECIFICATIONS

1. General

System	LaserVision Disc system and Compact Disc digital audio system
Laser	Semiconductor laser wavelength 780 nm
Power requirements	
CLD-V720	AC 120V, 60 Hz
CLD-1590K	AC 110/120/220/240 V (Switchable), 50/60 Hz
Power consumption	
CLD-V720	45 W
CLD-1590K	35 W
Weight	8.2 kg (18 lbs 1 oz)
Dimensions	420 (W) x 427 (D) x 139 (H) mm 16-9/16 (W) x 16-13/16 (D) x 5-1/2 (H) in
Operating temperature	+5°C ~ +35°C (41°F - 95°F)
Operating humidity	5% ~ 90% (There should be no condensation of moisture.)

2. Disc

LaserVision Discs

*Maximum playing times	
12-inch standard play disc	1 hour/both sides
12-inch extended play disc	2 hours/both sides
8-inch standard play disc	28 min/both sides 14 min/one side
8-inch extended play disc	40 min/both sides 20 min/one side
Spindle motor speed	
Standard play disc	1,800 rpm
Extended play disc	1,800 rpm (inner circumference) to 600 rpm (outer circumference) (For a 12-inch disc)

Compact Discs

DISC	Diameter: 5-inch, 3-inch, Thickness: 1.2 mm
Rotation direction (pickup side)	Counterclockwise
Liner speed	1.2 ~ 1.4m/sec
*Maximum playing time	
	74 min. 5-inch discs 20 min. 3-inch discs (For stereo playback)

Compact Discs with Video

Disc	Diameter: 5-inch, Thickness: 1.2 mm
Rotation direction (pickup side)	Counterclockwise
Linear speed	Audio portion: 1.2 ~ 1.4m/sec Video portion: 11 ~ 12m/sec
*Maximum playing time	Video portion: 5 min. (CLV) Audio portion: 20 min. (Digital)

* Actual playback time differs for each disc.

3. Video characteristics (two pairs)

Format	NTSC specifications
Video output	
Level	1 Vp-p nominal, sync. negative, terminated
Impedance	75Ω unbalanced
Jack	RCA jack

4. Audio characteristics (two pairs)

Output level	
During analog audio output	200 mVrms (1 kHz, 40%)
During digital audio output	200 mVrms (1 kHz, -20 dB)
Jacks	Both RCA jacks
Number of channels	2

5. Other Terminals

Control input/output	Both miniature jacks
AUX	RCA jacks
Number of channels	2
VHF adapter output (Video/Audio) (CLD-V720 only)	Both RCA jacks with DC jack

6. Accessories

Remote control unit (CU-CLD046)	1
Size "AAA" (IEC R03) dry cell batteries	2
Video cord	1
Audio cord	1
Operating instructions	1
Warranty card	1

SPECIFICATIONS

7. Functions

Remote control unit operations (CU-CLD046)

	Function	Standard play Disc (CAV)	Extended play Disc (CLV)	Compact Disc with Video	Compact Disc
Basic Functions	Single-side play Pause Stop Eject	YES YES YES YES	YES YES YES YES	YES YES YES YES	YES YES YES YES
Search	Fast forward (forward and reverse) Chapter/Track skip Direct chapter/Track number search Frame number search Time number search Absolute time search	YES YES YES YES NO NO	YES YES YES NO YES NO	YES YES YES NO YES NO	YES YES YES NO YES YES
Program	Chapter/Track program play Program correction	YES YES	YES YES	YES YES	YES YES
Repeat	Chapter/Track repeat One-side repeat Program repeat	YES YES YES	YES YES YES	YES YES YES	YES YES YES
Trick play	Still/Step	YES	NO	NO	NO
Time display	Elapsed time display Absolute time display Remaining track time display Remaining total time display Total number of selections, total time display	NO YES*1 NO YES*1 YES*1	YES NO NO YES*1 YES*1	YES NO YES YES YES	YES YES YES YES YES
Others	CX system ON/OFF AUTO DIGITAL/ANALOG switch Audio channel selection (Stereo, 1/L, 2/R)*4	YES*2 YES*3 YES	YES*2 YES*3 YES	NO NO YES	NO NO YES

*1 Only discs with TOC

*2 Valid for analog sound playing a disc with the  mark.

*3 Can only be used with discs with digital sound tracks.

*4 Only NORMAL mode

NOTE:

The specifications and design of this product are subject to change without notice, due to improvement.

Published by Pioneer Electronic Corporation
Copyright © 1991 Pioneer Electronic Corporation
All rights reserved.

LaserDisc is a trademark of Pioneer Electronic Corporation.

PIONEER ELECTRONIC CORPORATION 4-1, Meguro 1-Chome, Meguro-ku, Tokyo 153, Japan
PIONEER ELECTRONICS [USA] INC. 2265 East 220th Street Long Beach, California 90801, U.S.A.
P.O. BOX 1720 Long Beach, California 90801, U.S.A.
PIONEER ELECTRONICS OF CANADA, INC. 505 Cochrane Drive, Markham, Ontario L3R 8E3, Canada
PIONEER ELECTRONIC [EUROPE] N.V. Keetberglaan 1, 9120 Beveren, Belgium TEL: 03/750.05.11
PIONEER ELECTRONICS AUSTRALIA PTY. LTD. 173-184 Boundary Road, Braeside, Victoria 3195, Australia. TEL: (03) 580-9911