

# CLD-2750K CLD-1750K

NTSC

CD CDV LD PLAYER  
REPRODUCTOR DE CD, CDV Y LD  
CD CDV LD 鐳射碟影機

CLD-2750K

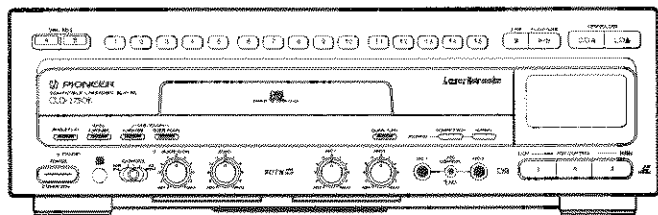

CLD-1750K

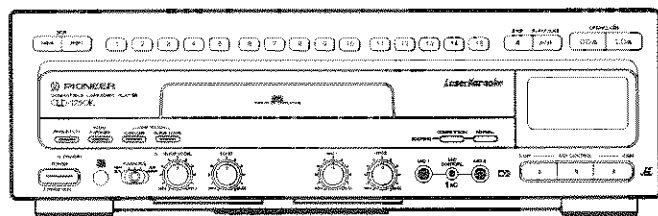

English

Español

中國語

- This player is not suitable for commercial use.
- LD-ROM, CD-ROM, VIDEO CD and CD graphic discs cannot be played with this player. (For details, refer to page 6.)

Thank you for buying this Pioneer product.  
Please read through these operating instructions so you will know how to operate your model properly. After you have finished reading the instructions, put them away in a safe place for future reference.  
In some countries or regions, the shape of the power plug and power outlet may sometimes differ from that shown in the explanatory drawings. However, the method of connecting and operating the unit is the same.

**WARNING:** TO PREVENT FIRE OR SHOCK HAZARD, DO NOT EXPOSE THIS APPLIANCE TO RAIN OR MOISTURE.

### IMPORTANT NOTICE

The serial number for this equipment is located on the rear panel. Please write this serial number on your enclosed warranty card and keep it in a secure area. This is for your security.

**LaserDisc LaserKaraoke**

COMPACT  
**disc**  
DIGITAL AUDIO

**L**  
LASER DISC

**CAUTION:** This product satisfies FCC regulations when shielded cables and connectors are used to connect the unit to other equipment. To prevent electromagnetic interference with electric appliances such as radios and televisions, use shielded cables and connectors for connections.

THE POWER SWITCH IS SECONDARY CONNECTED AND THEREFORE DOES NOT SEPARATE THE UNIT FROM MAINS POWER IN STANDBY POSITION.

# IMPORTANT



The lightning flash with arrowhead, within an equilateral triangle, is intended to alert the user to the presence of uninsulated "dangerous voltage" within the product's enclosure that may be of sufficient magnitude to constitute a risk of electric shock to persons.



**CAUTION:**  
TO PREVENT THE RISK OF ELECTRIC SHOCK, DO NOT REMOVE COVER (OR BACK). NO USER-SERVICEABLE PARTS INSIDE. REFER SERVICING TO QUALIFIED SERVICE PERSONNEL.



The exclamation point within an equilateral triangle is intended to alert the user to the presence of important operating and maintenance (servicing) instructions in the literature accompanying the appliance.

## SAFETY INSTRUCTIONS

**READ INSTRUCTIONS** – All the safety and operating instructions should be read before the appliance is operated.

**RETAIN INSTRUCTIONS** – The safety and operating instructions should be retained for future reference.

**HEED WARNINGS** – All warnings on the appliance and in the operating instructions should be adhered to.

**FOLLOW INSTRUCTIONS** – All operating and use instructions should be followed.

**CLEANING** – Unplug this video product from the wall outlet before cleaning. Do not use liquid cleaners or aerosol cleaners. Use a damp cloth for cleaning.

**ATTACHMENTS** – Do not use attachments not recommended by the video product manufacturer as they may cause hazards.

**WATER AND MOISTURE** – Do not use this video product near water – for example, near a bathtub, wash bowl, kitchen sink, or laundry tub, in a wet basement, or near a swimming pool, etc.

**ACCESSORIES** – Do not place this video product on an unstable cart, stand, tripod, bracket, or table. The video product may fall, causing serious injury to a child or adult, and serious damage to the appliance. Use only with a cart, stand, tripod, bracket, or table recommended by the manufacturer, or sold with the video product. Any mounting of the appliance should follow the manufacturer's instructions, and should use a mounting accessory recommended by the manufacturer.

**CART** – An appliance and cart combination should be moved with care. Quick stops, excessive force, and uneven surfaces may cause the appliance and cart combination to overturn.



**VENTILATION** – Slots and openings in the cabinet are provided for ventilation and to ensure reliable operation of the video product and to protect it from overheating. These openings must not be blocked or covered. They should never be blocked by placing the video product on a bed, sofa, rug, or other similar surface. This video product should never be placed near or over a radiator or heat register. This video product should not be placed in a built-in installation such as a bookcase or rack unless proper ventilation is provided or the manufacturer's instructions have been adhered to.

**POWER SOURCES** – This video product should be operated only from the type of power source indicated on the marking label. If you are not sure of the type of power supply to your home, consult your appliance dealer or local power company. For video products intended to operate from battery power, or other sources, refer to the operating instructions.

### POWER-CORD PROTECTION

Power-supply cords should be routed so that they are not likely to be walked on or pinched by items placed upon or against them. Pay particular attention to cords at plugs, convenience receptacles, and the point where they exit from the appliance.

**POLARIZATION** – This video product is equipped with a polarized alternating current line plug (a plug having one blade wider than the other). This plug will fit into the power outlet only one way. This is a safety feature. If you are unable to insert the plug fully into the outlet, try reversing the plug. If the plug should still fail to fit, contact your electrician to replace your obsolete outlet. Do not defeat the safety purpose of the polarized plug.

**LIGHTNING** – For added protection for this video product receiver during a lightning storm, or when it is left unattended and unused for long periods of time, unplug it from the wall outlet and disconnect the antenna or cable system. This will prevent damage to the video product due to lightning and power-line surges.

**POWER LINES** – An outside antenna system should not be located in the vicinity of overhead power lines or other electric light or power circuits, or where it can fall into such power lines or circuits. When installing an outside antenna system, extreme care should be taken to keep from touching such power lines or circuits as contact with them might be fatal.

**OVERLOADING** – Do not overload wall outlets and extension cords as this can result in the risk of fire or electric shock.

**OBJECT AND LIQUID ENTRY** – Never push objects of any kind into this video product through openings as they may touch dangerous voltage points or short-out parts that could result in a fire or electric shock. Never spill liquid of any kind on the video product.

**SERVICING** – Do not attempt to service this video product yourself as opening or removing covers may expose you to dangerous voltage or other hazards. Refer all servicing to qualified service personnel.

### DAMAGE REQUIRING SERVICE

Unplug this video product from the wall outlet and refer servicing to qualified service personnel under the following conditions:

- When the power-supply cord or plug is damaged.
- If liquid has been spilled, or objects have fallen into the video product.
- If the video product has been exposed to rain or water.
- If the video product does not operate normally by following the operating instructions. Adjust only those controls that are covered by the operating instructions. Improper adjustment of other controls may result in damage and will often require extensive work by a qualified technician to restore the video product to its normal operation.
- If the video product has been dropped or the cabinet has been damaged.
- When the video product exhibits a distinct change in performance – this indicates a need for service.

**REPLACEMENT PARTS** – When replacement parts are required, be sure the service technician has used replacement parts specified by the manufacturer or having the same characteristics as the original part. Unauthorized substitutions may result in fire, electric shock or other hazards.

**SAFETY CHECK** – Upon completion of any service or repairs to this video product, ask the service technician to perform safety checks to determine that the video product is in proper operating condition.

**OUTDOOR ANTENNA GROUNDING** – If an outside antenna is connected to the antenna terminal, be sure the antenna system is grounded so as to provide some protection against voltage surges and built-up static charges.

In the U.S.A. section 810 of the National Electrical Code, ANSI/NFPA 70, provides information with respect to proper grounding of the mast and supporting structure, grounding of the lead-in wire to an antenna discharge unit, size of grounding conductors, location of antenna-discharge unit, connection to grounding electrodes, and requirements for the grounding electrode.

See Fig. A.

NEC – NATIONAL ELECTRIC CODE

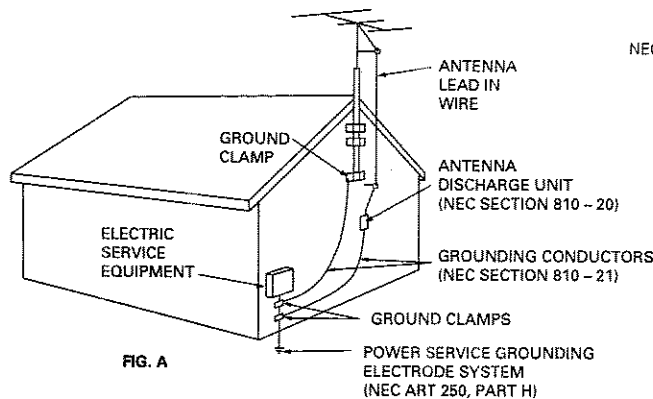

This equipment has been tested and found to comply with the limits for a Class B digital device, pursuant to Part 15 of the FCC Rules. These limits are designed to provide reasonable protection against harmful interference in a residential installation. This equipment generates, uses, and can radiate radio frequency energy and, if not installed and used in accordance with the instructions, may cause harmful interference to radio communications. However, there is no guarantee that interference will not occur in a particular installation. If this equipment does cause harmful interference to radio or television reception, which can be determined by turning the equipment off and on, the user is encouraged to try to correct the interference by one or more of the following measures:

- Reorient or relocate the receiving antenna.
- Increase the separation between the equipment and receiver.
- Connect the equipment into an outlet on a circuit different from that to which the receiver is connected.
- Consult the dealer or an experienced radio/TV technician for help.

### Information to User

Alteration or modifications carried out without appropriate authorization may invalidate the user's right to operate the equipment.

### CAUTION

- Use of controls or adjustments or performance of procedures other than those specified herein may result in hazardous radiation exposure.
- The use of optical instruments with this product will increase eye hazard.

### Note to CATV system installer

This reminder is provided to call the CATV system installer's attention to Article 820-40 of the NEC that provides guidelines for proper grounding and, in particular, specifies that the cable ground shall be connected to the grounding system of the building, as close to the point of cable entry as practical.



### Dear Customer:

Selecting fine audio equipment such as the unit you've just purchased is only the start of your musical enjoyment. Now it's time to consider how you can maximize the fun and excitement your equipment offers. This manufacturer and the Electronic Industries Association's Consumer Electronics Group want you to get the most out of your equipment by playing it at a safe level. One that lets the sound come through loud and clear without annoying blaring or distortion—and, most importantly, without affecting your sensitive hearing.

Sound can be deceiving. Over time your hearing "comfort level" adapts to higher volumes of sound. So what sounds "normal" can actually be loud and harmful to your hearing. Guard against this by setting your equipment at a safe level BEFORE your hearing adapts.

#### To establish a safe level:

- Start your volume control at a low setting.
- Slowly increase the sound until you can hear it comfortably and clearly, and without distortion.

#### Once you have established a comfortable sound level:

- Set the dial and leave it there.

Taking a minute to do this now will help to prevent hearing damage or loss in the future. After all, we want you listening for a lifetime.

## We Want You Listening For A Lifetime

Used wisely, your new sound equipment will provide a lifetime of fun and enjoyment. Since hearing damage from loud noise is often undetectable until it is too late, this manufacturer and the Electronic Industries Association's Consumer Electronics Group recommend you avoid prolonged exposure to excessive noise. This list of sound levels is included for your protection.

#### Decibel

Level	Example
30	Quiet library, soft whispers
40	Living room, refrigerator, bedroom away from traffic
50	Light traffic, normal conversation, quiet office
60	Air conditioner at 20 feet, sewing machine
70	Vacuum cleaner, hair dryer, noisy restaurant
80	Average city traffic, garbage disposals, alarm clock at two feet.

#### THE FOLLOWING NOISES CAN BE DANGEROUS UNDER CONSTANT EXPOSURE

90	Subway, motorcycle, truck traffic, lawn mower
100	Garbage truck, chain saw, pneumatic drill
120	Rock band concert in front of speakers, thunderclap
140	Gunshot blast, jet plane
180	Rocket launching pad

Information courtesy of the Deafness Research Foundation.



# ACCESSORIES

When unpacking the player, first check to make sure that all of the accessories listed below are supplied.

- Remote control unit
- Size "AAA" (IEC R03) dry cell battery x 2

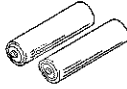

CLD-2750K



CLD-1750K

- Video cord  
(Pin plug ↔ Pin plug)  
Use to connect the player to a color monitor etc.

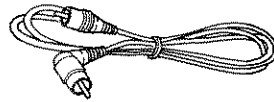

CLD-2750K

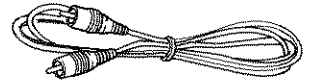

CLD-1750K

- Audio cord  
(Pin plug x 2 ↔ Pin plug x 2)  
Use to connect the player to a stereo amplifier etc.

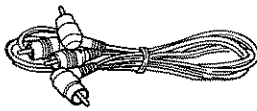

CLD-2750K

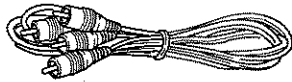

CLD-1750K

- Power cord

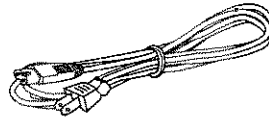

- Operating instructions
- Warranty card

# CONTENTS

## BEFORE OPERATING THE PLAYER

ACCESSORIES .....	4
PRECAUTIONS .....	5
TYPES OF DISCS THAT CAN BE PLAYED WITH THIS UNIT .....	6
CARE OF DISCS .....	7
CONNECTIONS .....	8
NAMES AND FUNCTIONS .....	10
REMOTE CONTROL OPERATIONS .....	12

## BASIC OPERATION

TO PLAY AN LD, CDV OR CD .....	13
--------------------------------	----

## VARIOUS OPERATIONS

CONVENIENT FUNCTIONS FOR KARAOKE .....	15
CONVENIENT FUNCTIONS FOR PLAYING AN LD, CDV OR CD .....	20
TO SEARCH FOR A PARTICULAR TIME/FRAME .....	21
TO PLAY ONLY DESIRED SCENES/TRACKS .....	22
TO REPEATEDLY PLAY A DESIRED PASSAGE .....	23
DISPLAY SWITCHING .....	24
TRUBLESHOOTING .....	25
SPECIFICATIONS .....	28

## PRECAUTIONS

If it becomes necessary to transport or ship this unit in the future, be sure to first remove the disc (if loaded), and retract the disc table to its closed position. Then turn the power off, and, after the "OFF" display goes out on the display, disconnect the power cord.

### INSTALLING THE PLAYER

- Place the player on a stable platform next to the television and stereo system to be used with the player.
- Do not place heavy objects such as a television or TV monitor on top of the player.
- Do not place the player on top of your TV set or TV monitor. Also, keep the player away from devices such as cassette decks which are sensitive to magnetic fields.

### DO NOT INSTALL THE PLAYER IN THE FOLLOWING LOCATIONS

- In a place subject to direct sunlight.
- In humid or poorly ventilated places.
- In extremely hot or cold places.
- In a place subject to vibrations.
- In a dusty place.
- In a place subject to soot, steam or heat (in a kitchen, etc.)

### AVOID SOURCES OF HEAT

Do not put the player on sources of heat, such as an amplifier. When installing with audio components on a rack, avoid components that generate heat, by placing the player below such components where there is adequate ventilation and not much dust. Avoid placing the player on surfaces such as shaggy carpets, beds, and sofas which may block ventilation under the player and cause damage.

### CAUTION

Even when the player is in the pause mode, the disc-drive motor is still revolving. Since leaving the player in this condition can shorten the lifetime of the motor, do not leave the player in the pause mode for long periods of time. Also, to prevent the damage to the screen, do not use the unit for long periods of time under conditions in which the screen display (monitor) has been displayed characters (for example, power-ON mode, CD PLAY, PAUSE or DEMO mode (see back cover)). With LD discs, if playback is paused for about 20 minutes, the player will automatically enter stop mode.

### STRIPE PATTERNS APPEARING ON A TV PROGRAM

Stripe patterns may appear during a TV program if the player unit is turned on, depending on the quality of reception of the TV station. This is neither a malfunction of the television nor the player. If stripes appear while watching the TV, or when watching the TV for long periods of time, turn the player off.

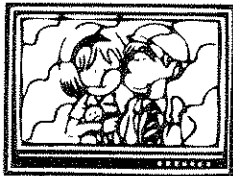

### CAUTION FOR INSTALLATION INSIDE A RACK WITH GLASS DOOR

Be cautious so that the disc table does not hit the glass when the table is opened by pressing the OPEN/CLOSE (▲) button of the remote control unit. The disc table may fall in malfunction if its motion is obstructed by a strong force.

When FM or AM stations are being received, signal noise may be generated if the player is turned on. Turn off the player when not in use. Also, if there is signal noise when receiving radio stations with an indoor antenna, adjust the position or direction of the antenna.

### CONDENSATION

**Moisture will form in the operating section of the player if the player is brought from cool surroundings into a warm room or if the temperature of the room rises suddenly. When this happens, player's performance will be impaired.**

**To prevent this, let the player stand in its new surroundings for about an hour before switching it on, or make sure that the room temperature rises gradually.**

Condensation may also form during the summer if the player is exposed to the breeze from an air conditioner. In such cases, change the location of the player.

### POWER-CORD CAUTION

Handle the power cord by the plug. Do not pull out the plug by tugging the cord and never touch the power cord when your hands are wet as this could cause a short circuit or electric shock. Do not place the unit, a piece of furniture, etc., on the power cord, or pinch the cord. Never make a knot in the cord or tie it with other cords. The power cords should be routed such a way that they are not likely to be stepped on. A damaged power cord can cause fire or give you an electrical shock. Check the power cord regularly. When you find it damaged, ask your nearest PIONEER authorized service center or your dealer for a replacement.

### CLEANING CARE

Use a soft, dry cloth for cleaning. For stubborn dirt, soak the cloth in a weak detergent solution; wring well first and wipe. Use a dry cloth to wipe it dry. Do not use any volatile agents such as benzine or paint thinner, as they may damage the surface of the player.

### LD/CD lens cleaner

The player's pickup lens should not become dirty in normal use, but if for some reason it should malfunction due to soiling, ask your nearest PIONEER authorized service center. Lens cleaners for LD/CD players are commercially available, but special care should be exercised in their use since some may cause damage to the lens.

**Abnormal functioning of this unit may be caused by lightning, static electricity, or other external interference. To restore normal operation, unplug the AC power cord and then plug it in again.**

**Only one disc can be loaded at any one time. Loading a LaserDisc, a Compact Disc, a 8 cm Compact Disc or a Compact Disc with Video on top of one another may result in a breakdown, or in scratching of the discs. Please only load one disc at a time.**

**This player is to be used exclusively with the NTSC color system. Please use NTSC LaserDisc only. PAL and SECAM system discs cannot be used with this player.**

5

<VRB1149>











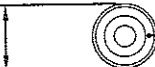

En

# TYPES OF DISCS THAT CAN BE PLAYED WITH THIS UNIT

This unit is a CD VIDEO SYSTEM compatible player which can play CDs, CDV discs, and LDs.

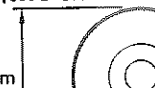
\* The marks shown in the right column are printed on the labels and jackets of the corresponding discs.

This player can play the following seven types of discs without using an adapter.

<p><b>CD Single (one-side recording)</b></p> <p>8 cm  Digital audio (max. 20 min.)</p>	
<p><b>CD (one-side recording)</b></p> <p>12 cm  Digital audio (max. 74 min.)</p>	
<p><b>CDV (one-side recording)</b></p> <p>12 cm  Digital audio (max. 20 min.) (Audio part) Digital audio + Video (max. 5 min.) (Video part)</p>	 **
<p><b>VSD (Video Single Disc) (one-side recording)</b></p> <p>12 cm  Digital audio + Video (max. 5 min.)</p> <p>● In the operating instructions in this manual, the VSD is treated as a kind of CDV.</p>	
<p><b>LD Single (one-side recording)</b></p> <p>20 cm  Digital/analog audio + Video (CAV: Max. 14 min. CLV: Max. 20 min.)</p>	 *
<p><b>LD (two-side or one-side recording)</b></p> <p>20 cm  Digital/analog audio + Video (CAV: Max. 14 min. per side CLV: Max. 20 min. per side)</p>	 *
<p><b>LD (two-side or one-side recording)</b></p> <p>30 cm  Digital/analog audio + Video (CAV: Max. 30 min. per side CLV: Max. 60 min. per side)</p>	 **

Discs other than those noted above cannot be played back with this player. (i.e., Video CD, CD-ROM, LD-ROM, Hi-vision LD, etc.)

## Caution

VIDEO CD  or  cannot be played with this player.

The Video CD is a disc holding up to 74 minutes of digital video and audio signals, when recorded in the MPEG format.

## HOW TO PLACE A DISC

Place the disc in the correct position by using the appropriate disc guide groove.

LD disc table: 

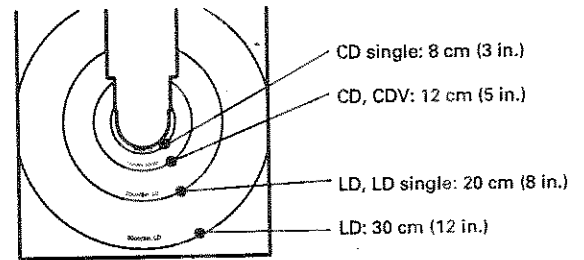

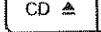
CD disc table: 

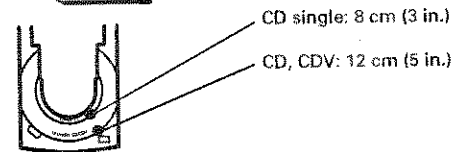

## LD GLOSSARY

### Chapter number

Chapter numbers are used to indicate the boundaries of the sections on a disc. If chapter numbers are recorded on a disc, it is so indicated on the jacket of the disc, etc.

### Frame number

Frame numbers are the numbers assigned to each picture frame on a CAV disc.

### Time number

Time numbers indicate the time elapsed from the beginning of a CLV disc.

## CDV/CD GLOSSARY

### Track number

Track numbers indicate the boundaries of the sections, or "tracks", on a disc. Track numbers are assigned consistently throughout the audio part and video part of a CDV disc.

### TOC



The TOC (Table of Contents) section is just like the table of contents of a book, and contains information on the contents (number of tracks, playing time, etc.) of the disc.

- Some LD discs are not provided with a TOC section.

\* This is the unified symbol mark of LASERDISC (LaserVision videodisc).

LaserDisc players and discs which bear this symbol and use the same television system, are mutually compatible.

\*\* A Digital Audio with Multi Audio Disc (CD VIDEO LD) and a CDV (CD Video CDV) are referred to as CD Video discs. CD Videodiscs are recorded with subcodes, which are the non-audio recordings of TOC (Table of Contents) data such as track numbers, index numbers, etc. However, there are some discs without these marks.

- There are some discs marked with the  mark instead of the  mark.
- There are some disc without the  mark.

## CARE OF DISCS

### LDs (LASERDISCS)

Two types of standard LaserDisc are available — standard play (CAV) discs and extended play (CLV) discs — which differ with respect to their signal recording systems.

### CAV DISCS

The jackets and labels of these discs are marked with a "Standard Play Disc CAV" or "Standard Play" indication.

### CLV DISCS

The jackets and labels of these discs are marked with a "Extended Play Disc CLV" or "Extended Play" indication.

### LASERVISION DISCS WITH DIGITAL AUDIO

The jackets and labels of these discs bear the following mark.

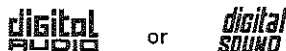

These are LaserDiscs which contain digital audio signals in addition to conventional analog audio signals. This feature allows the high image quality of LaserDiscs to be enjoyed together with the superior quality of digital audio.

### LASERVISION MULTI AUDIO DISCS WITH DIGITAL AUDIO

The jackets and labels of these discs bear the following mark.



These are LaserDiscs in which the recorded digital and analog audio signals differ in content. This allows the user to enjoy two different audio soundtracks by switching between the digital and analog audio.

### Notes on AC-3 discs

- This player is not capable of providing the 5.1 CH digital surround audio even when LD software with Dolby AC-3 compatibility is played.
- When LD software with Dolby AC-3 compatibility is played with this player, it is possible to digital stereo audio or analog monaural audio.

### CDV (COMPACT DISC WITH VIDEO) DISCS

These are compact discs which also contain video signals. Of the total 25-minute playback time of a CDV disc, 20 minutes is encoded with conventional CD digital audio signals (the "audio part"). The remaining 5 minutes is encoded with both video and digital audio signals (the "video part"). In normal playback mode, the unit plays the audio part after the video part is played back.

### How to hold discs

When loading or removing discs, try not to touch their playing surfaces.



### Cleaning

Fingerprints or other dirt on the disc may affect sound and picture quality.

To clean your discs, use a soft clean cloth to wipe them. If necessary, moisten a soft cloth with diluted neutral detergent to remove heavy dirt or fingerprints.



Do not wipe in a circular direction  
(Concentric scratches in the disc groove tend to cause noise.)

Gently wipe from the inside toward the outer edge.

Discs must not be cleaned with record cleaning sprays, or static prevention sprays, etc. Also do not use volatile liquids such as benzene, or thinner, etc.

### NEVER PLAY CRACKED OR WARPED DISCS.

- The disc revolves in the player at a high speed when it is played. Never play a cracked, scratched or warped disc. This may damage the player or cause it to malfunction.

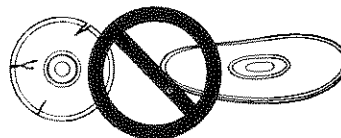

### After using discs, store them upright

After playing a disc, always remove it from the player and return it to its jacket. Then store it standing upright away from heat and humidity.

- Store discs carefully. If you store discs at an angle, or stacked on top of each other, discs may become warped even when in their jackets.
- Do not leave discs in locations such as the seat of car, which may become excessively hot.

### CAUTION WHEN USING THE DISC

All rights reserved.

Unauthorized public performance, broadcasting or copying is a violation of applicable laws.

# CONNECTIONS

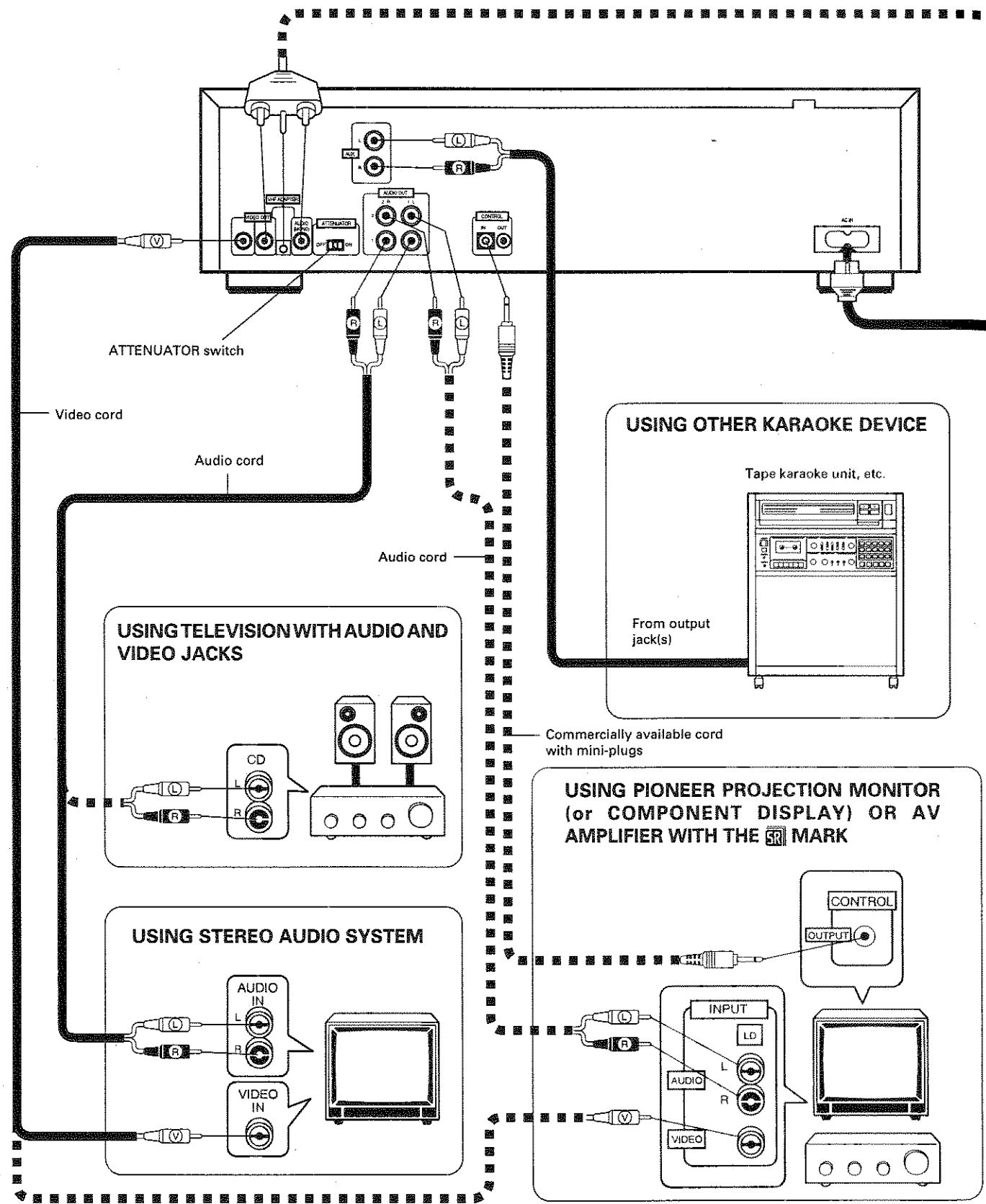



Finally plug the accessory power cord to the AC power jack and a household power outlet (which should permanently be supplied with power.)

### PLUG THE POWER CORDS INTO AN AC OUTLET

Plug the AC power cords of the player, stereo amplifier and TV set into an AC outlet. When the power cord of this unit is connected to an AC outlet, power is supplied to the unit's internal memory (such as the last memory) even when the POWER switch is off (STANDBY). Therefore, be sure to connect the power cord directly to a wall outlet. If the power cord is connected to an outlet such as a switched outlet on an amplifier, the various memory contents will be erased whenever the amplifier's power switch is turned off.

### USING TELEVISION WITHOUT AUDIO AND VIDEO JACKS

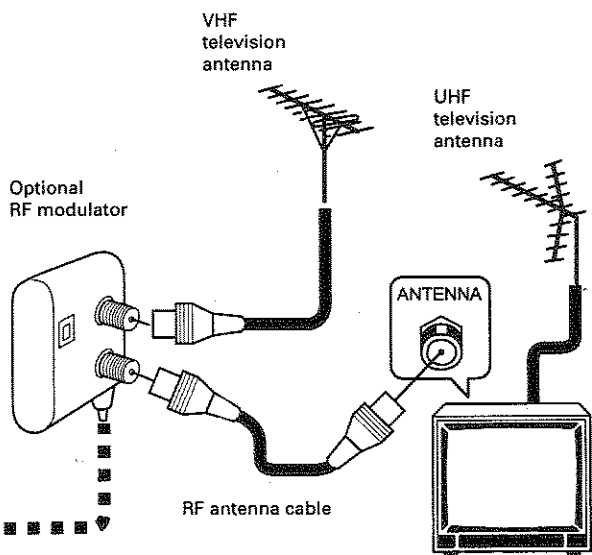

1. Detach the VHF antenna cable from the VHF antenna terminal of your TV set, and connect the cable to the VHF IN terminal of the RF modulator.
2. Connect the VHF OUT terminal of the RF modulator to the VHF antenna terminal of your TV set.
3. Connect the socket (3-pin) of the RF modulator to the VHF ADAPTER jacks.

#### NOTE:

Push the plug in firmly. If the plug is not properly inserted, it may result in snow or noise on the screen.

When the sound from a LaserDisc or Compact Disc is output through a television speaker it becomes monaural sound (This is the same for a stereo television).

#### NOTES:

- Stripe patterns may appear when a LaserDisc is played on a television. Move the antenna cable away from the power cord to avoid this.
- Be sure to turn off the power of this player when you watch a TV broadcast.

### CONNECTING TV AND STEREO AMPLIFIER

- Connect the VIDEO OUT jack of the player to the video input jack of the monitor television.
- Connect the AUDIO OUT jacks to the stereo amplifier AUX, CD, LD, VDP or other jacks, except the PHONO input jacks. The television speakers can also be used by connecting the television audio input jacks and the player AUDIO OUT jacks. However, connection to a stereo amplifier is recommended to obtain superior audio playback quality for Compact Discs and LaserDiscs. Do not change the television antenna and VCR connections.

### THE SR MARK

System control can be performed when the player is combined with an optional AV amplifier, which can provide centralized control of Pioneer products with the SR mark.

Connect the VIDEO OUT jack of the player to the video disc video input jack of the AV amplifier and connect the AUDIO OUT jacks of the player to the audio input jacks of the AV amplifier.

Connect the CONTROL IN jack of the player to the CONTROL OUT jack of the AV amplifier using a commercially available cord with mini-plugs.

- For details concerning the connection and operation methods, please refer to the operating instructions for the AV amplifier.

### ATTENUATOR SWITCH

When the television speakers are used, the sound may be distorted. In this case, set the ATTENUATOR switch to ON to reduce the distortion.

# NAMES AND FUNCTIONS

## Front panel:

A detailed description is provided on the indicated page(s).

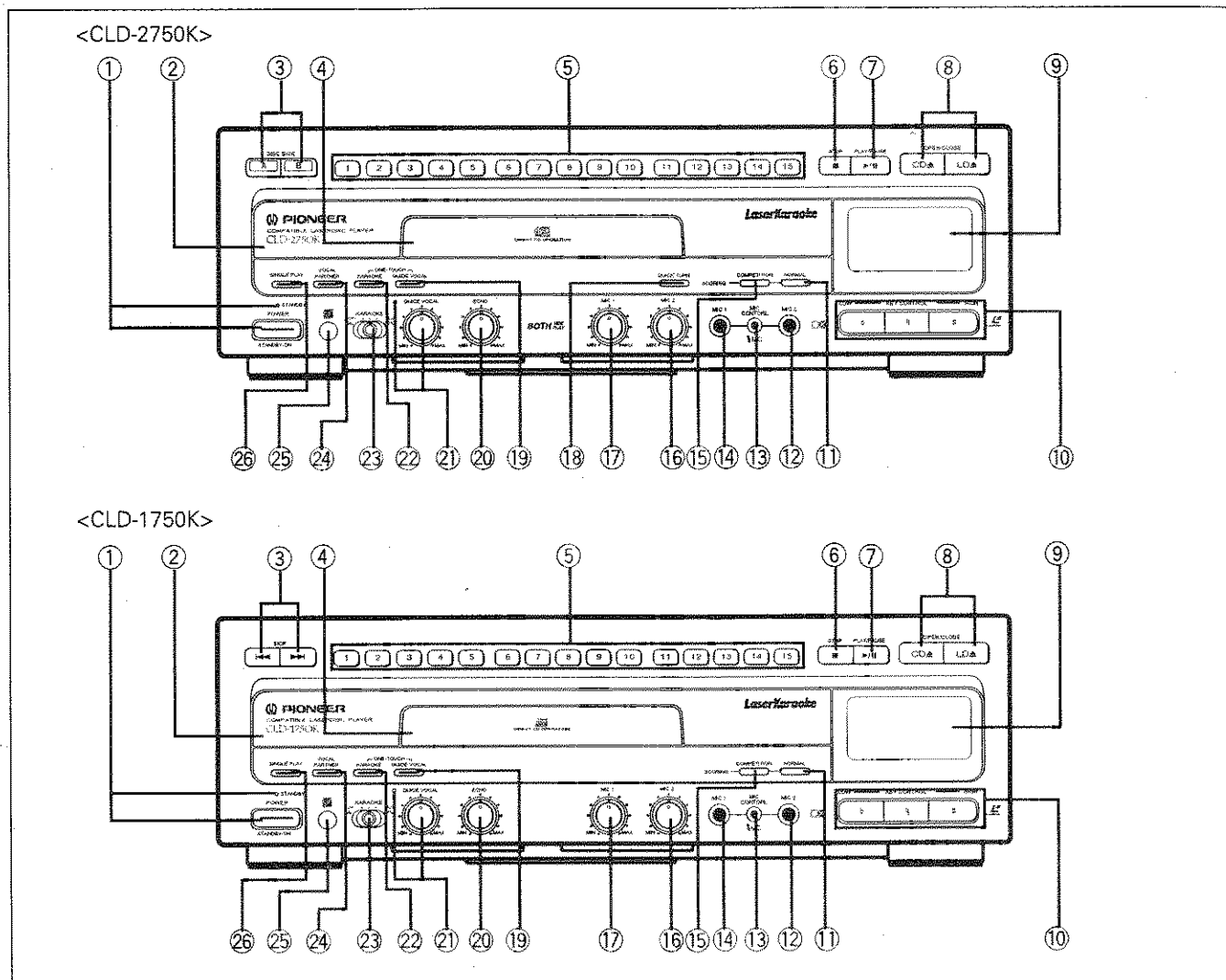

- |   |   |
|---|---|
| ① <b>POWER STANDBY/ON switch and STANDBY indicator</b><br>Press to turn the power on and off.                   | ⑬ <b>MIC CONTROL jack</b> ... p. 13                                       |
| ② <b>Disc table</b> ... p. 13   | ⑭ <b>MIC 1 jack</b>   |
| ③ <b>DISC SIDE A/SIDE B buttons (CLD-2750K only)</b> ... p. 14<br><b>SKIP button (CLD-1750K only)</b> ... p. 21 | ⑮ <b>SCORING COMPETITION button</b> ... p. 19                             |
| ④ <b>CD Disc table</b> ... p. 13  | ⑯ <b>MIC 2 level control</b> ... p. 13                                    |
| ⑤ <b>Direct music search buttons</b> ... p. 13, 18, 19, 22  | ⑰ <b>MIC 1 level control</b> ... p. 13                                    |
| ⑥ <b>STOP (■) button</b> ... p. 14  | ⑱ <b>QUICK TURN ON/OFF button/indicator</b><br>(CLD-2750K only) ... p. 20 |
| ⑦ <b>PLAY/PAUSE (▶/⏸) button</b> ... p. 13, 14  | ⑲ <b>ONE-TOUCH GUIDE VOCAL button/indicator</b><br>... p. 16, 17          |
| ⑧ <b>OPEN/CLOSE (CD ▲/LD ▲) buttons</b> ... p. 13, 14   | ⑳ <b>ECHO level control</b> ... p. 15                                     |
| ⑨ <b>Display window</b>   | ㉑ <b>GUIDE VOCAL level control/indicator</b> ... p. 16                    |
| ⑩ <b>KEY CONTROL buttons</b> ... p. 15  | ㉒ <b>ONE-TOUCH KARAOKE button/indicator</b> ... p. 16, 17                 |
| ⑪ <b>SCORING NORMAL button</b> ... p. 18  | ㉓ <b>NORMAL/KARAOKE/AUX INPUT selector</b> ... p. 13, 20                  |
| ⑫ <b>MIC 2 jack</b>   | ㉔ <b>VOCAL PARTNER button/indicator</b> ... p. 16, 17                     |
|   | ㉕ <b>Remote sensor</b> ... p. 12  |
|   | ㉖ <b>SINGLE PLAY button/indicator</b> ... p. 15                           |

## Display window

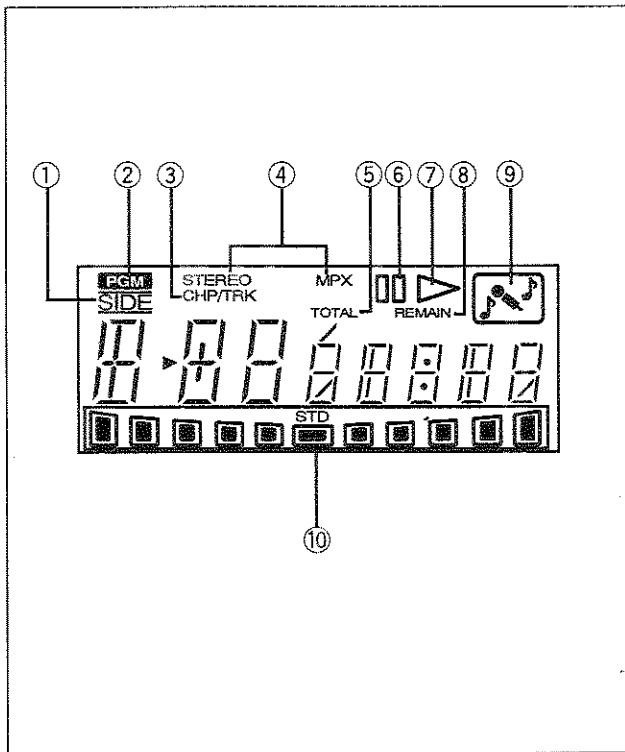

- ① **SIDE indicator**
- ② **PGM (Program) indicator**
- ③ **Chapter number/Track number indicator**
- ④ **Audio mode indicators**  
Display the type of the played audio signal when the KARAOKE or AUX input is selected.
- ⑤ **TOTAL indicator**
- ⑥ **|| Pause indicator**
- ⑦ **▶ Play indicator**
- ⑧ **REMAIN indicator**
- ⑨ **KARAOKE indicator**
- ⑩ **Key control indicator**

## Remote control unit:

Remote control buttons with the same names or marks as buttons on the front panel of the player control.

The illustration shows CLD-2750K.

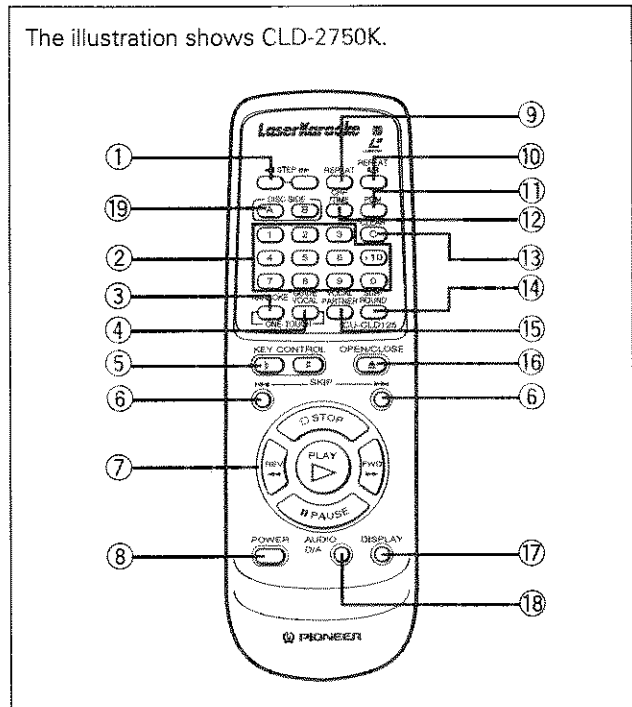

- ① **STEP (◀|||▶) buttons ... p. 21**
- ② **Digit buttons ... p. 13, 18, 19, 22**
- ③ **ONE-TOUCH KARAOKE button ... p. 16, 17**
- ④ **ONE-TOUCH GUIDE VOCAL button ... p. 16, 17**
- ⑤ **KEY CONTROL buttons ... p. 15**
- ⑥ **SKIP buttons ... p. 21**
- ⑦ **Operation buttons**  
■ : **STOP button ... p. 14**  
▶ : **PLAY button ... p. 13, 14**  
|| : **PAUSE button ... p. 13, 14**  
◀◀/▶▶ : **Scan buttons ... p. 21**
- ⑧ **POWER button ... p. 13**
- ⑨ **REPEAT button ... p. 23**
- ⑩ **REPEAT A-B button ... p. 23**
- ⑪ **PGM (Program) button ... p. 22**
- ⑫ **CHP/TIME (Chapter/Time) button ... p. 21**
- ⑬ **CLEAR button ... p. 21, 22, 23**
- ⑭ **SURROUND button ... p. 15**
- ⑮ **VOCAL PARTNER button ... p. 16, 17**
- ⑯ **OPEN/CLOSE (▲) button ... p. 13**
- ⑰ **DISPLAY button ... p. 24**
- ⑱ **AUDIO D/A button ... p. 20**
- ⑲ **DISC SIDE A/B buttons (CLD-2750K only) ... p. 14**

## REMOTE CONTROL OPERATIONS

### INSERTING BATTERIES INTO THE REMOTE CONTROL UNIT

Open the battery compartment cover on the back of the remote control unit.

Insert size "AAA" (IEC R03) dry cell batteries into the battery compartment in accordance with the indications (⊕, ⊖) inside the compartment.

Close the cover of the battery case.

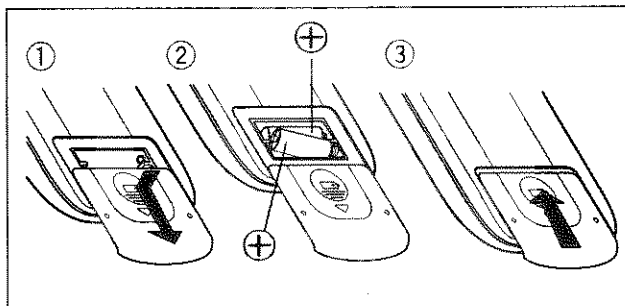

*Incorrect use of batteries may cause leakage or rupture.*

*Always be sure to follow these guidelines:*

- A. Always insert batteries into the battery compartment correctly matching the positive ⊕ and negative ⊖ polarities, as shown by the display inside the compartment.
- B. Never mix new and used batteries.
- C. Batteries of the same size may have different voltages, depending on brand. Do not mix different brands of batteries.

*When the unit is not to be used for a long period of time (more than one month), remove the batteries to prevent them from leaking inside the compartment. If leakage occurs, wipe up the liquid inside the compartment and replace the batteries with new ones.*

### Remote controllable range

Angle: Within 30 degrees to the left and right of the center line

Distance: Less than 7 m

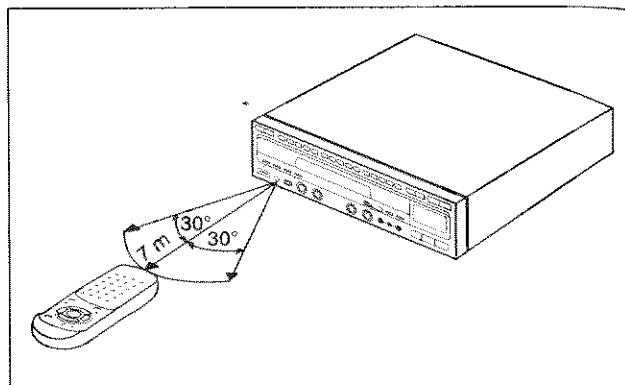

### NOTES FOR USING THE REMOTE CONTROL UNIT:

- If a plug is connected to the CONTROL IN terminal at the rear of the player, remote control operations cannot be done with the remote control unit aimed at the player's remote sensor. Aim the remote control unit at the control component display's sensor instead.
- If the player is used simultaneously with another appliance using infrared rays, the player may operate improperly. Should this happen, change the place of installation so that improper operation does not occur.
- If the range of operation of the remote control unit becomes too short, replace the batteries.
- If the remote sensor is in a position where it receives strong light such as sunlight or fluorescent light, control may not be possible.

# TO PLAY AN LD, CDV OR CD

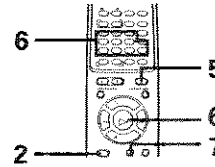
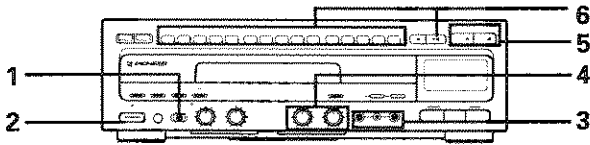

<b>NORMAL PLAYBACK</b>	<b>KARAOKE PLAY</b>	<b>PLAYBACK WITH USING OTHER DEVICES</b>
------------------------	---------------------	--

<p><b>1 Set the NORMAL/KARAOKE/AUX INPUT selector to the NORMAL position.</b></p>	<p><b>1 Set the NORMAL/KARAOKE/AUX INPUT selector to the KARAOKE position.</b></p>	<p><b>1 Set the NORMAL/KARAOKE/AUX INPUT selector to the AUX INPUT position.</b></p>
---	--	--

**2 Turn on the power to this player.**

**3 Connect and turn on the microphone(s).**  
 About microphones:  
 When using a separately sold microphone such as the Pioneer Microphone DM-V161, connect the control-use miniplug to the player's MIC CONTROL (MC) jack.

**4 Adjust the microphone level.**

**5 Load a disc.**

- If **OPEN/CLOSE** on the remote control unit is pressed to open the disc table: The LD disc table comes out when an LD is loaded. The CD disc table comes out when a CD is loaded.

**6 Start playback.**

<p>When starting playback from the first chapter or track on a disc:</p>	<p>When starting playback from the desired chapter or track on a disc: (Example) starting playback from track No. 3</p>
--	---

## TO PLAY AN LD, CDV OR CD

### ■ When KARAOKE play is finished

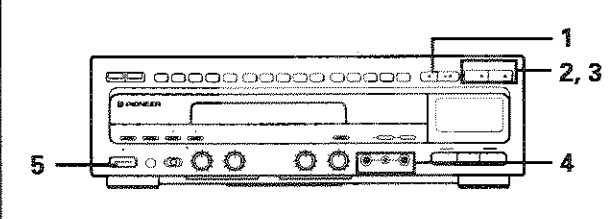

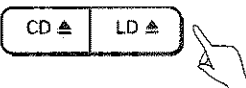

- 1 Press the stop (■) button.**  
STOP  

- 2 Press the OPEN/CLOSE (CD ▲/LD ▲) button.**
  - When OPEN/CLOSE on the remote control unit is pressed, the disc table on which a disc is loaded comes out.

OPEN/CLOSE

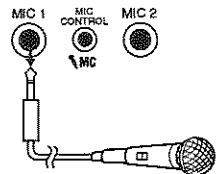
- 3 Take out a disc and press the OPEN/CLOSE (CD ▲/LD ▲) button to close the disc table.**
  - Be sure to close the disc table completely.

OPEN/CLOSE

- 4 (Except for normal playback) Turn off the microphone(s) and unplug the microphone's plug from the MIC jack.**
  - With the microphone having the mini-plug for control, unplug the mini-plug for control first and then unplug the microphone's plug.
- 5 Turn off the power of the player.**  
POWER  
  
STANDBY/ON

#### \* Precautions concerning disc loading

- Do not place more than one disc on the disc table. If two discs are placed one on top of the other on the disc table, discs may be scratched and/or a malfunction may occur.
- Playback is not possible unless the disc is placed properly.

### ■ If some of the Direct music search buttons are pressed sequentially

- The last selected track is played back.
- Be sure to press the Direct music search button which corresponds to the chapter number or the track number.

### ■ To search for chapter or track number 10 or above

Use [+10] button.

(Example) To enter 17: [+10], [7]

To enter 30: [+10], [+10], [+10], [0]

### ■ If howl occurs

- Keep away the microphone from the speakers.
- Decrease the output level of the microphone by turning the MIC 1 or MIC 2 level control counterclockwise.
- Decrease the volume level by turning the **VOLUME** control of the amplifier counterclockwise.

### ■ If sound distortion occurs

- Set the **ATTENUATOR** switch on the rear panel to the ON position. (See page 8, 9.)

### ■ About the microphone

- Clean the microphone's plug. If the plug is dirty, it may result in noise.
- Use a microphone for karaoke. If using the microphone not for karaoke, it may cause of insufficient volume level or howling.

### ■ To pause playback temporarily

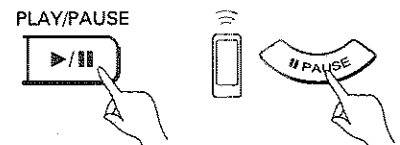

Press ►/|| or PAUSE || again to resume playback.

#### <CLD-2750K only>

### ■ To select a song on the other side (For two-sided LDs)

Specify side A or side B with **DISC SIDE A** or **B** and then select a song using the **Direct music search** buttons.

### ■ To specify and play a single side (side A or side B)

To play side A only, press **DISC SIDE A** instead of ►/||. Side A will be played and then playback will stop.

To play side B only, press **DISC SIDE B** instead of ►/||. Side B will be played and then playback will stop.

### To avoid malfunctions, be especially careful about the following points.

- Do not place any object other than a disc on the disc table.
- Do not move the player while a disc is playing. This will cause the disc to be scratched.
- Be careful not to catch your finger in the disc table section while the disc table is being retracted into the unit. Also, be careful that children do not put their hands into the inside of the unit while the disc table is open. This may cause injury.

# CONVENIENT FUNCTIONS FOR KARAOKE

## To adjust the microphone echo level

In karaoke, AUX mode

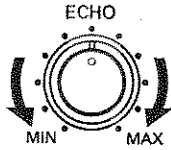

Echo is increased by turning the control to the right and decreased by turning the control to the left.

## To create a live atmosphere (Surround function)

In karaoke, normal, AUX mode

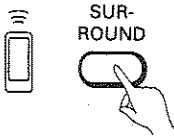

### On screen displays for SURROUND

Lights	Function
THEATER	Theater
KARAOKE	Karaoke
MUSIC	Music
OFF	Surround off

#### NOTE:

With discs whose volume level is excessive high, sound may be distorted when the surround function is activated. In this case, set **SURROUND** to OFF.

Press the **SURROUND** button, then select THEATER, KARAOKE or MUSIC to create the desired atmosphere.

**THEATER:** Creates an atmosphere suitable for movie discs.

**KARAOKE:** Creates an atmosphere suitable for karaoke play.

**MUSIC:** Creates an atmosphere suitable for music discs.

## To set a desired pitch (Key control function)

In karaoke, AUX mode

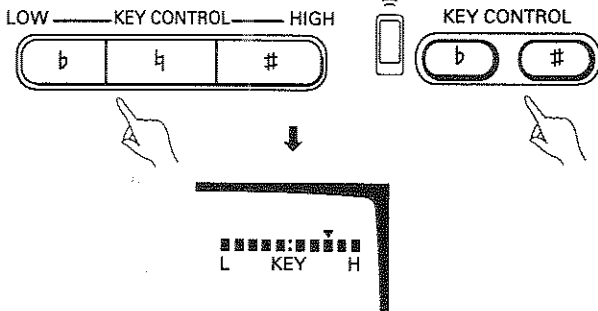

# : Pitch is heightened each time this button is pressed (up to 5 steps from normal).

h : Pitch returns to normal.

b : Pitch is lowered each time this button is pressed (down to 5 steps from normal).

- The current pitch position is shown by the lit indicator.

#### NOTE:

Key control does not function when the **NORMAL/KARAOKE/AUX INPUT** selector is set to the **NORMAL** position.

## To repeat a section to correct a singing mistake

Only in karaoke mode

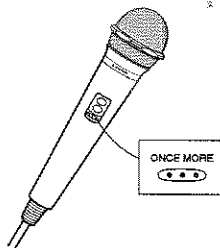

This function can be operated with the microphone sold separately (Pioneer DM-V161).

Each time **ONCE MORE** is pressed, playback returns to a point a little earlier in the song.

However, the position will not return to a point earlier than the beginning of the selected song.

When playback returns to the beginning of the selected song and pauses, press **II** or **ONCE MORE** to start playback.

- If you press **ONCE MORE** while the player is in pause mode, playback will resume. (Once more start function)

## To play a single track

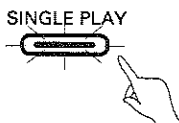

- The unit is in single play mode when the indicator is lit (on). You can playback continuously when the indicator is out (off).

- When you change the position of the **NORMAL/KARAOKE/AUX INPUT** selector, the initial settings are as follows:

**KARAOKE:** single play mode (indicator lights)

The single play mode is not available when the **NORMAL/KARAOKE/AUX INPUT** selector is set to **NORMAL** or **AUX**.

- The single play mode is activated automatically during **SCORING (NORMAL/COMPETITION)** and cannot be switched off.

## CONVENIENT FUNCTIONS FOR KARAOKE

**ONE-TOUCH GUIDE VOCAL**— Suitable for karaoke practice by allowing you to hear the guide vocal (Available with karaoke LD)

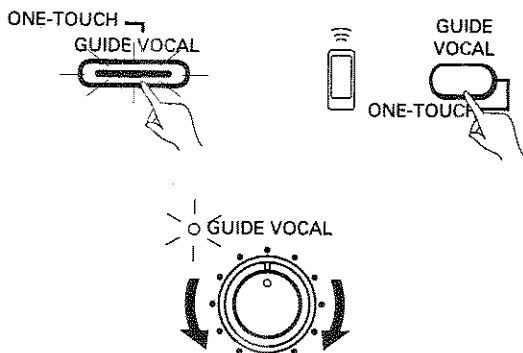

- If you want to hear the guide vocal (the vocal of a singer recorded as example), press the **ONE-TOUCH GUIDE VOCAL** button.

### NOTES:

- The one-touch guide vocal function can be used only with discs containing the recording of guide vocal (audio multiplex discs). Do not press this button when playing other discs.
- While the indicator above the **GUIDE VOCAL volume** control is lit, the volume of the guide vocal can be adjusted by turning the control knob.
- In case the guide vocal is heard from the right channel or the guide vocal volume cannot be adjusted though the indicator above the **GUIDE VOCAL volume** control is lit, press the **ONE-TOUCH GUIDE VOCAL** button again. This will make it possible to adjust the guide vocal volume.

**ONE-TOUCH KARAOKE** — For karaoke singing with an ordinary disc by attenuating the recorded vocal (Available with LD only)

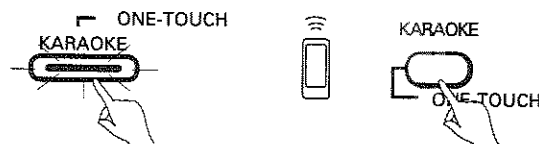

- If you want to sing karaoke along with an ordinary music disc, press the **ONE-TOUCH KARAOKE** button. The voice canceler is activated to attenuate the vocals of the singers.

### NOTES:

- The one-touch karaoke function may have little effect with certain discs.
- In case the disc is a karaoke disc and the guide vocal is heard from the right channel, press the **ONE-TOUCH KARAOKE** button twice. This will mute the guide vocal.

**VOCAL PARTNER** — Convenient for karaoke singing of a song you cannot recall well by replacing the singer's voice with your own voice only while you sing (Available with LD only)

When you sing into microphone, the singer's voice is attenuated.

<Front panel indicator is lit.>

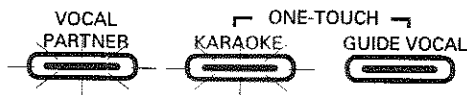

When you stop singing, the singer's vocal is heard at the normal level.

<Front panel indicator is lit.>



- The Vocal Partner function attenuates the singer's voice only while you sing into microphone. This function is useful when you practice a new song or a song which should be sung alternately by two people.
- Press the **VOCAL PARTNER** button to attenuate the singer's voice while you sing.

### NOTES:

- The singer's voice may not be attenuated so much with certain discs.
- While the indicator above the **GUIDE VOCAL volume** control is lit, the volume of the guide vocal can be adjusted by turning the control knob.
- In case the guide vocal is heard from the right channel or the singer's voice is not attenuated at all while you sing, press the **VOCAL PARTNER** button again.

### NOTES:

- With certain discs, the **ONE-TOUCH GUIDE VOCAL**, **ONE-TOUCH KARAOKE** and **VOCAL PARTNER** functions may not be able to be switched off unless the button is pressed twice.
- When the quick-turn function (page 20) is on, the **ONE-TOUCH KARAOKE** and **VOCAL PARTNER** functions may sometimes not function properly. To enjoy karaoke, it is recommended to always switch the quick-turn function off. (CLD-2750K only)





## CONVENIENT FUNCTIONS FOR KARAOKE (SCORING-NORMAL)

Your karaoke song is scored compared with vocals recorded on the disc. When you finish to sing karaoke, press **PAUSE (II)**. The score is displayed and then the bells are rung and cheers are heard according to the score.

**1 Set the NORMAL/KARAOKE/AUX INPUT selector to the KARAOKE position.**

**2 Press the SCORING NORMAL button.**

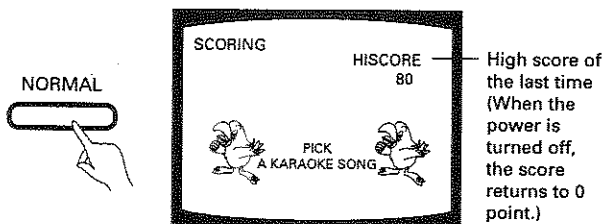

**3 Select the karaoke song with the Direct music search buttons.**

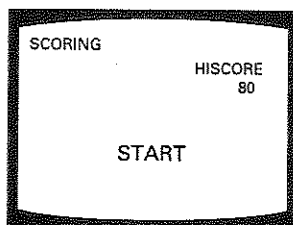

- When selecting songs, use the Direct music search buttons on the front panel or the Digit buttons on the remote control unit.

**4 Sing a karaoke song.**

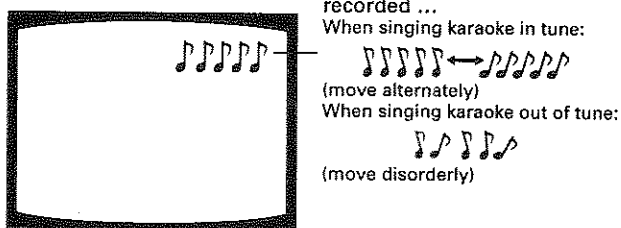

### NOTES:

- The **SCORING** function can be used only when the **NORMAL/KARAOKE/AUX INPUT** selector is set to **KARAOKE**.
- During selecting the chapter or displaying the score, **PAUSE (II)**, **PLAY (▶)**, **SKIP (◀◀, ▶▶)** and **SCAN (◀◀, ▶▶)** do not function.
- The following functions are not performed in scoring mode.  
Repeat, Surround, Programming, Clear Scan, Time display on the screen, VOCAL PARTNER, ONE-TOUCH KARAOKE.

**5. The player automatically enters pause mode after the tune is over.**

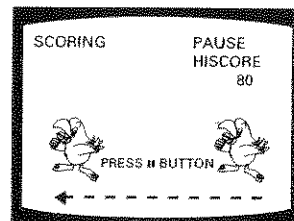

**6 Press PAUSE (II) button.**

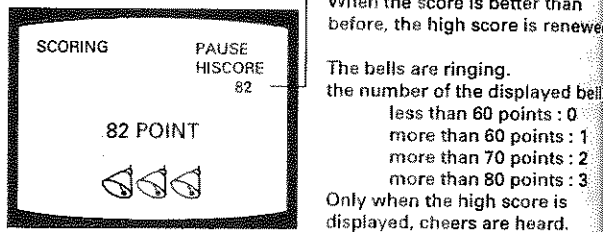
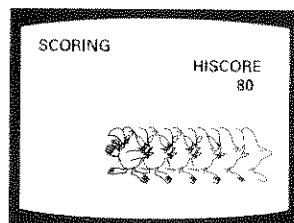

After several seconds, the player automatically returns to step 2. You can try another karaoke song repeating steps 2 and 3.

**To return to normal karaoke mode:**

- Press the **SCORING-NORMAL** button again.
- Press **CLEAR** on the remote control unit.

**During scoring ...**

- The fast-forward, fast-reverse, once more or key control function can be carried out.
- When the another karaoke song is selected, the previous score displayed on the screen is reset.
- The single play mode is activated automatically and cannot be switched off.

- Depending on the type of disc or song, it may not possible to correctly determine the musical interval (the difference in pitch between tones) of the vocals, even with karaoke discs, and it becomes difficult to obtain a high score. This is not a malfunction.
- If you sing during parts with no vocals, it is counted as scoring and you won't be able to see your actual score. On the other hand, the score will not be affected even if you do not sing along in sections containing vocals.

## CONVENIENT FUNCTIONS FOR KARAOKE (SCORING COMPETITION)

You can score your performances when singing duets.

**1 Set the NORMAL/KARAOKE/AUX INPUT selector to the KARAOKE position. Plug microphones into MIC 1 and 2 jacks and switch the microphones on.**

**2 Press the SCORING COMPETITION button.**

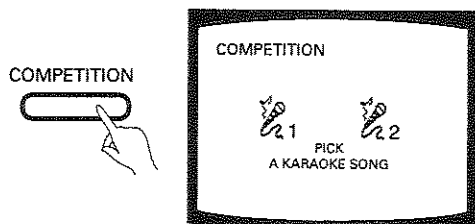

**3 Select the karaoke song with the Direct music search buttons.**

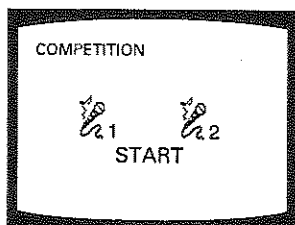

● When selecting songs, use the Direct music search buttons on the front panel or the Digit buttons on the remote control unit.

**4 Start singing the duet.**

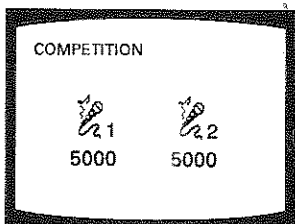

Scoring starts at 5000 points and increases or decreases in 100 point intervals.

**5 When the song is over, the player enters pause mode and displays the scores for mics 1 and 2.**

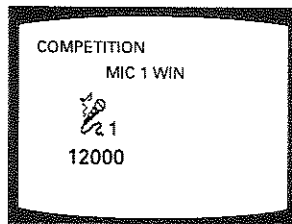
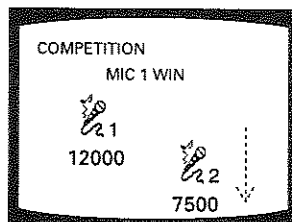
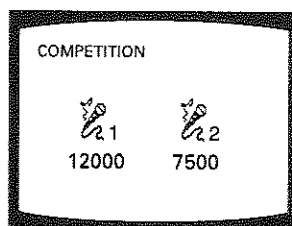

The winner flashes and the loser sinks off the bottom of the screen.

When the same score

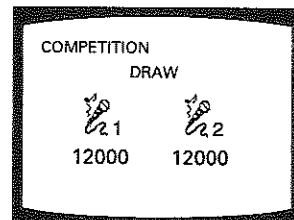

After a few seconds, the display returns to step 2 and you can repeat steps 3 through 5.

**To return to normal karaoke mode:**

- Press the **SCORING COMPETITION** button again.
- Press **CLEAR** on the remote control unit.

**During scoring ...**

- The fast-forward, fast-reverse, once more or key control function can be carried out.
- When the another karaoke song is selected, the previous score displayed on the screen is reset.
- The single play mode is activated automatically and cannot be switched off.

### NOTES:

- The **SCORING COMPETITION** function can be used only when the **NORMAL/KARAOKE/AUX INPUT** selector is set to **KARAOKE**.
- During selecting the chapter or displaying the score, **PAUSE** (⏸), **PLAY** (▶), **SKIP** (⏮, ⏭) and **SCAN** (◀, ▶) do not function.
- The following functions are not performed in competition mode.  
Repeat, Surround, Programming, Clear Scan, Time display on the screen, **VOCAL PARTNER**, **ONE-TOUCH KARAOKE**

- Depending on the type of disc or song, it may not possible to correctly determine the musical interval (the difference in pitch between tones) of the vocals, even with karaoke discs, and it becomes difficult to obtain a high score. This is not a malfunction.
- If you sing during parts with no vocals, it is counted in scoring and you won't be able to see your actual score. On the other hand, the score will not be affected even if you do not sing along in sections containing vocals.

# CONVENIENT FUNCTIONS FOR PLAYING AN LD, CDV OR CD

## Audio switching

This function is carried out when the **NORMAL/KARAOKE/AUX INPUT** selector is set to the **NORMAL** position.



## Switching audio

Each time **AUDIO D/A** is pressed during playback, audio output is switched. For example;

- to hear only the analog audio of a disc with digital audio
- to hear only one channel of stereo disc
- to select audio of the multiplex disc

### LD

#### LD with digital audio

Audio source can be switched between digital audio, analog audio, L channel and R channel of stereo audio.

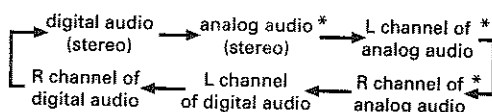

- When an AC-3 compatible disc is played and the analog audio is selected, all of the three kinds of audio marked \* above will become 1/L monaural audio and "1/L ONLY" is displayed on the bottom left of the screen.

#### LD with analog audio

- With a disc encoded with CX auto-switching signals

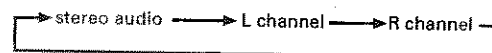

- With a disc not encoded with CX auto-switching signals

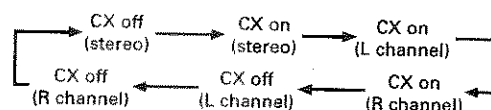

#### CD or CDV

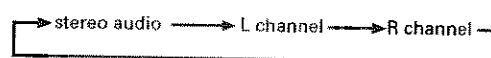

With a Multi Audio disc (an LD bearing the **digital** mark and the **MULTI AUDIO** mark or the **MULTI AUDIO** mark), you can listen to the various audio tracks recorded on the disc by using **AUDIO** to select between the analog and digital tracks, and to select between the left (1/L) and right (2/R) channels.

## To reduce the playback start time and turn time (QUICK-TURN)-CLD-2750K only

The indicator lights when the quick-turn function is on.

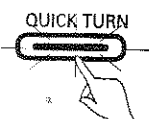

- Press **QUICK TURN** to turn this function off.
- When the quick-turn is on, the TOC recorded on the disc is not read so the time required before starting playback or turning the disc can be reduced.

As a result, even when the LD being played contains TOC information, **total time display, remaining time display and the elapsed time display of CAV (standard play) disc** with not function.

### Discs marked with the **OX** mark

Discs marked **OX** are recorded with the CX noise reduction system for powerful audio reproduction with little noise. (Analog audio only) However, some discs marked **OX** are not encoded with the signals necessary to instruct the unit to automatically switch on the CX system. If sound is noisy or undulates when a disc with a **OX** mark is played, press **AUDIO D/A** on the remote control unit.

- **OX** is a trademark of CBS Inc. This player meets the CX EXPANDING SPECIFICATION.

### NOTES:

- The quick-turn is turned off automatically when a CD is inside the player.
- The quick-turn on/off setting returns to the initial condition when the power is turned off or the **NORMAL/KARAOKE/AUX** switch position is changed.
- The initial conditions when the **NORMAL/KARAOKE/AUX** switch position is changed are as follows.  
**NORMAL:** On (Indicator is lit.)  
**KARAOKE:** Off (Indicator is not lit.)  
**AUX:** Off (Indicator is not lit.)

### Automatic picture stop

Some of discs contain a recording of a special code called the "picture stop code", which turns normal play or slow play automatically into still frame display.

To cancel the automatic picture stop operation, press and hold **▶/II** for more than 2 seconds until "PSC ON" (picture stop cancel ON) is displayed on the screen. To re-activate, press and hold **▶/II** for more than 2 seconds again until "PSC OFF" is displayed. (**▶** or **II** on the remote control unit cannot be used.)

## CONVENIENT FUNCTIONS FOR PLAYING AN LD, CDV OR CD

### Chapter (Track) Skip - To search for the beginning of a chapter/track

LD/CD/CDV

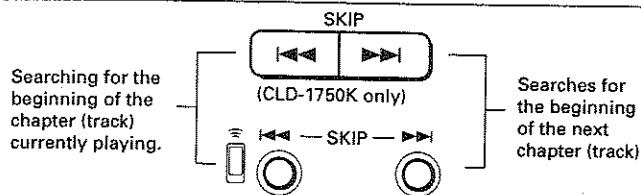

Press a button repeatedly or hold it depressed; the chapters (tracks) will be skipped successively.

### Still frame and Frame -by-Frame advance function (CAV disc only)

LD



Press repeatedly for frame-by-frame advance.

### Scan (Manual Search) - Search using fast forward or fast reverse

When the **Track/manual search** button is pressed in playback mode, playback advances or reverses at high speed. There are three scan modes.



Normally Low Scan and High Scan is performed. To perform Clear Scan, press **DISPLAY** on the remote control unit to display the screen and then press **◀◀** or **▶▶**. For about two seconds after the button is pressed, Low Scan is performed, after that, the unit enters High Scan.

**Low Scan mode:** Scan speed becomes about x10 of the normal playback speed.

**High Scan mode:** Scan speed becomes about x30 of the normal playback speed.

**Clear Scan mode:** The image may not fluctuate in this mode.

- With video part of CDV, High Scan mode cannot be carried out.
- In Clear Scan mode, when digital sound is selected with digital audio discs, sound is heard at a low volume level.
- With CDs or audio part of CDVs, sound is heard at a low volume level while scanning.
- Others: Sound is muted.
- The screen image may be disturbed during scanning, but this is not a malfunction.

LD/CDV/CD

## TO SEARCH FOR A PARTICULAR TIME/FRAME

### Frame Number Search/Time Number Search

#### Frame Number Search (CAV discs only) - To search by designating the frame number

Any desired frame can be searched for by specifying its frame number.

1. Press **CHP/TIME** during playback.
2. Enter the required frame number with the digit buttons (0 - 9).
3. Press **▶/II** or **PLAY ▶**.

#### Time Number Search (CLV disc only)

- Example: To search for the scene located at 12 min. 34 sec

1. Press **CHP/TIME** during playback.
2. Enter **1**, **2**, **3** and **4** with the digit buttons.
3. Press **▶/II** or **PLAY ▶**.

#### CAUTION:

If a disc does not contain information in seconds, specify the time number only in the minutes.

When **PLAY ▶** on the remote control unit is pressed to start search operation:

A still frame is displayed (CAV). To start normal playback, press **PLAY ▶** again.

#### Notes on searching for a chapter/track:

- If you make a mistake in pressing the digit buttons, press **CLEAR** and press the correct digit buttons.
- The **⏮** button does not function.

#### To exit search mode:

Press **CLEAR**. Normal playback starts.

21

<VRB1149>

En

## TO PLAY ONLY DESIRED SCENES/TRACKS – Program Playback

Selected chapters (LD) or tracks (CDV/CD) can be played in any desired order (max. 24 chapters or tracks).

### 1. Press PGM.

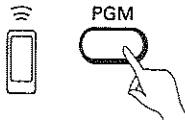

Display with a disc containing a TOC

3	0.12	PLAY
TOTAL TIME	PROGRAM	
0 0.00	STEP- 1	
▶		

### 2. Enter the track No. with the DIRECT MUSIC SEARCH buttons on the front panel or with the digit buttons on the remote control unit.

**Example:** To play CD tracks No. 9, No. 7, and No. 18 respectively.

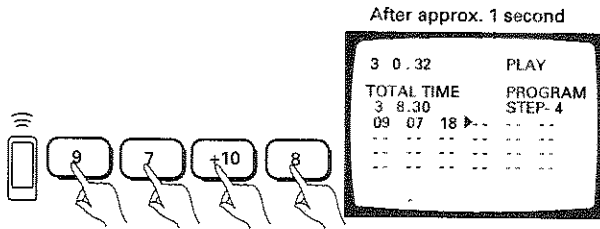

#### <CLD-2750K only>

With two-sided LDs, first specify side A or side B with DISC SIDE A or B and then enter the number of the desired chapter with the digit buttons.

**Example:** To program chapter 9 on side B, chapter 7 on side A, and chapter 18 on side B, in that order.

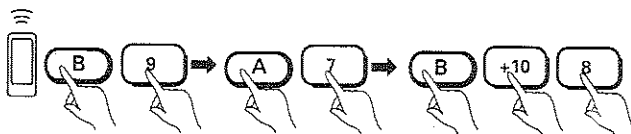

Screen display after programming is completed

3	0.12	A PLAY
TOTAL TIME	PROGRAM	
B09 A07 B18 ▶	STEP- 4	

A pause between tracks/chapters can also be programmed by pressing **PAUSE** **||** instead of the digit buttons.

#### If you make a mistake during entry:

Press **CLEAR** on the remote control unit and enter the correct number with the digit buttons.

### 3. Press ▶/|| or PLAY ▶.

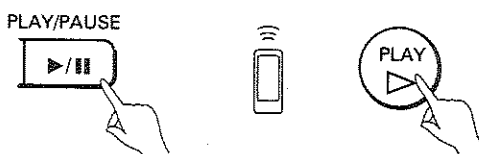

- You can view the state of programming on the monitor TV screen.

#### To check the program contents

During program playback or in stop mode, press **PGM**. The display the program contents on the monitor screen. When **PGM** is pressed again, the program contents disappear.

#### To modify the program contents

To delete or change a programmed chapter/track or pause:

- Press **PGM**.
  - Press **SKIP** **◀◀** or **▶▶** to place the cursor (▶) on the side of the chapter/track or pause to be changed.
  - To delete it, press **CLEAR**. To replace it with another chapter/track, enter the new chapter/track number with the digit buttons.  
Press **PAUSE** **||** to enter a pause.
  - Press **PGM** to complete programming. Pressing **▶** completes programming and starts program playback with the new program contents.
- Programmed chapter/track being played cannot be erased or changed.
  - Programmed pause being engaged cannot be erased or changed.

#### To clear the program playback

Press **CLEAR** to return to normal playback.

#### To clear the program contents:

- Open the disc table.
- Press **CLEAR** in stop mode.

#### NOTES:

- If **SCAN** **▶▶** is held depressed during Program Playback, the playback position will move to another chapter/track, but when **▶▶** is released, the next chapter/track in the program will be played. If **◀◀** is held depressed, playback position returns to the beginning of the current chapter or track being played, but it will not go beyond a previous chapter or track in the program.
- During program playback, **SKIP** **◀◀** and **▶▶** can be used to skip the programmed chapters/tracks or pause.

## TO REPEATEDLY PLAY A DESIRED PASSAGE – Repeat Playback

### Memory Repeat – To specify a point to return to later

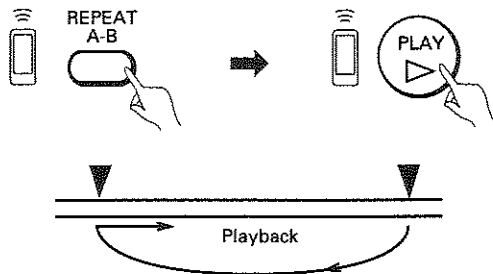

Press **REPEAT A-B** on the remote control unit at the point you want to see or listen to again (point A).

When you wish to return to point A, press **▶** on the remote control unit.

### A-B Repeat – To repeat a specified section

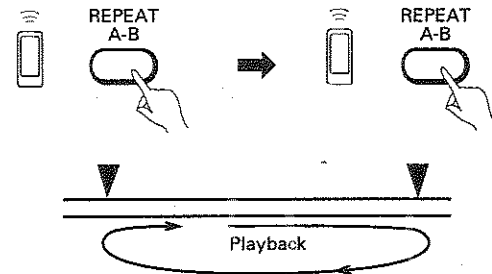

Press **REPEAT A-B** on the remote control unit at the start point of the section to be repeated.

Press **REPEAT A-B** on the remote control unit at the end point of the section to be repeated. Playback returns to the beginning of the section and the section is repeated continuously.

### Chapter/Track Repeat – To repeat the current chapter or track

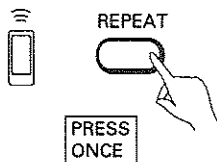

Press **REPEAT** on the remote control unit while the chapter/track to be repeated is playing. When the end of the chapter/track is reached, the player returns to the beginning of the chapter/track and the chapter/track is played back repeatedly.

### Program Repeat – To repeat a program

With the program repeat function, you can repeatedly play programmed chapters or tracks in their programmed order.

Press **REPEAT** on the remote control unit while the program is being played.

- See page 22 for details on programming.

### One Side Repeat – To repeat an entire side of a disc

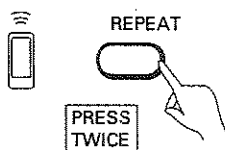

Press **REPEAT** on the remote control unit twice. When playback reaches the end of the playback side, the player returns to the beginning of the disc and the same side is played back repeatedly.

### Two-Side Repeat – To repeat both side of a disc (for two-sided LDs only — CLD-2750K)

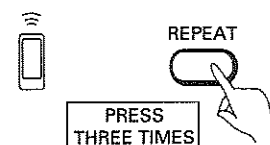

Press **REPEAT** on the remote control unit three times. Sides A and B are played back repeatedly. "Repeat ALL" appears on the monitor screen.

#### To exit repeat mode:

Press **CLEAR** on the remote control unit.

#### To specify a different point in Memory Repeat mode:

Press **CLEAR** to cancel the previously memorized point, and repeat the same operation as shown above. The previously memorized point is erased and replaced with the new point.

#### Memory Repeat and A-B Repeat with CDV discs:

These repeat functions can only be carried out within the video part or within the audio part, and cannot be carried out between the two parts.

#### With LDs which have no chapter numbers:

Chapter repeat cannot be carried out.

# DISPLAY SWITCHING

DISPLAY on the remote control unit allows you to display information including the play mode and disc playing time on the screen. Each press of DISPLAY switches the screen display as shown below.

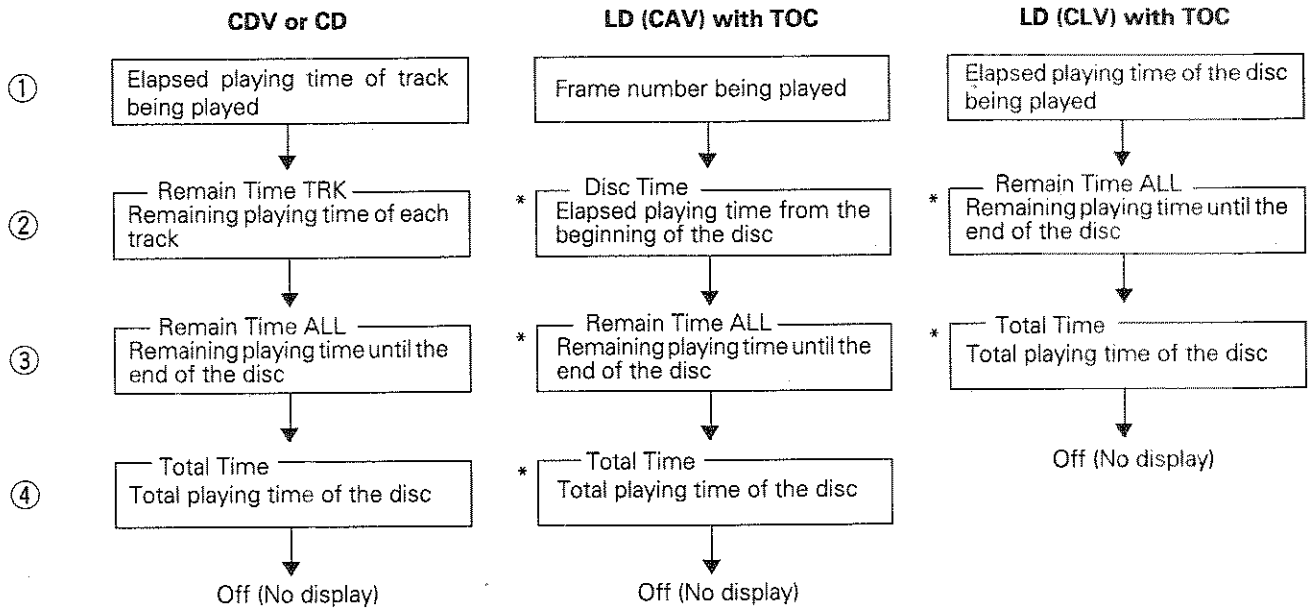

### LD discs without TOC:

Frame number (CAV)/Elapsed playing time (CLV) and Display-off mode are switched alternately on the display.

### NOTE:

Even with a LD with TOC, the information marked \* cannot be displayed when quick-turn is on (refer to page 20). To display the information, stop playback and switch quick-turn off before restarting playback.

During playback, if you press the remote control unit's **DISPLAY** button, the following information screens will appear.

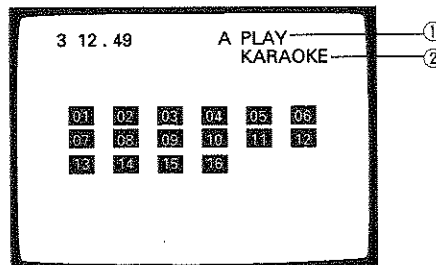
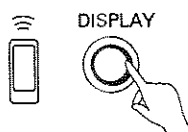

- ① Player status
- ② Player mode:
  - KARAOKE: Karaoke mode
  - NORMAL: Normal mode
  - AUX: Auxiliary input mode

The actual screen display is as shown below.

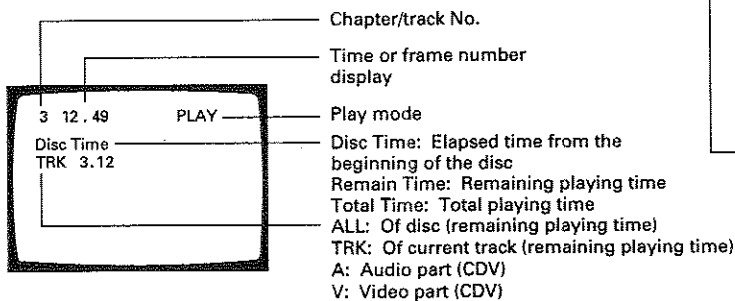

The screen display disappears automatically if you leave it for a long time (for about 80 minutes or more) without any operation. In this case, press any button on the remote control unit so that the screen display will appear on the screen.



# TROUBLESHOOTING

Incorrect operations are often mistaken for trouble and malfunctions. If you think that there is something wrong with this component, check the points below. Sometimes the trouble may lie in another component. Inspect the other components and electrical appliances being used. If the trouble cannot be rectified even after exercising the checks listed below, ask your nearest PIONEER authorized service center or your dealer to carry out repair work.

## Common to LD and CD

	Symptom	Possible Causes	Reference Page
Operation	1. The disc comes out even when the disc table is closed.	<ul style="list-style-type: none"> <li>● The disc is dirty or warped.</li> <li>● The disc is not placed properly on the disc table.</li> <li>● Condensation formed inside the player.</li> </ul>	p. 7 p. 6 p. 5
	2. The player pauses automatically.	<ul style="list-style-type: none"> <li>● The <b>SINGLE PLAY</b> button is pressed to on.</li> </ul>	p. 15
Remote control	3. Remote control operation is not possible.	<ul style="list-style-type: none"> <li>● The control input input jacks are in use.</li> <li>● The remote control unit is too far from the player.</li> <li>● The batteries are exhausted.</li> </ul>	p. 8, 9 p. 12 p. 12
	4. Improper operation of TV set, etc., occurs.	<ul style="list-style-type: none"> <li>● Improper operation may occur with some TV sets.</li> </ul>	
Audio	5. Audio is not output or distorted.	<ul style="list-style-type: none"> <li>● The connection between the player and amplifier is erroneous or the plugs are not inserted fully into the jacks.</li> <li>● The connection plug of the jack is dirty.</li> <li>● The player is in pause mode.</li> <li>● A wrong input is selected on the amplifier.</li> <li>⇒ Refer to the operating instructions of the amplifier.</li> </ul>	p. 8, 9  p. 13
		<ul style="list-style-type: none"> <li>● The audio output is connected to the PHONO input jacks of the amplifier.</li> </ul>	p. 8, 9

## LD

	Symptom	Possible Causes	Reference Page
Video, picture quality	6. TV programs cannot be viewed.	<ul style="list-style-type: none"> <li>● The power of the player is not connected.</li> <li>● The VHF antenna is not connected.</li> <li>● A cable supplying the mixed signal of VHF and UHF signals is connected to the adapter.</li> <li>● The input selector of the TV is not set properly.</li> </ul>	p. 8, 9  p. 8, 9
	7. The video cannot be viewed, the picture quality is poor or noise interferes with the video.	<ul style="list-style-type: none"> <li>● The disc is dirty or warped.</li> <li>● The power of the TV is turned off.</li> <li>● The attenuator switch is set to off.</li> <li>● The connection is erroneous or the plugs are not inserted fully into the jacks.</li> </ul>	p. 7  p. 8, 9
	8. A part of the still frame image shakes.	<ul style="list-style-type: none"> <li>● The still frame image may shake if it shows a dynamic scene.</li> </ul>	p. 21
Audio	9. Audio sound is undulating. *	<ul style="list-style-type: none"> <li>● A disc which does not carry the CX mark is played while the CX system is ON.</li> </ul>	p. 20
	10. Audio is not output.	<ul style="list-style-type: none"> <li>● The player is in the still frame or frame-by-frame advance mode.</li> </ul>	p. 21
Skip search	11. Skip, programming and search operations do not function properly.	<ul style="list-style-type: none"> <li>● The disc does not contain chapter number information. (The functions utilizing the chapter numbers cannot be used in this case.)</li> </ul>	p. 21, 22
	12. The search takes a long time (more than 40 seconds).	<ul style="list-style-type: none"> <li>● Some discs require much time for readout of data.</li> </ul>	
	13. The start takes time.	<ul style="list-style-type: none"> <li>● Some discs tend to cause subcode readout error. (This is not a malfunction.)</li> <li>⇒ Try pressing the stop and play buttons repeatedly to stop and restart playback. This repetition may sometimes make normal playback possible.</li> </ul>	
	14. A different time number than specified is searched.	<ul style="list-style-type: none"> <li>● Some discs tend to cause subcode readout error. (This is not a malfunction.)</li> </ul>	

## TROUBLESHOOTING

### CD

	Symptom	Possible Causes	Reference Page
Operation	15. Playback stops immediately after it has been started.	<ul style="list-style-type: none"> <li>● The disc is dirty.</li> <li>● The disc is not placed upside down.</li> <li>● The disc is not placed properly on the disc table.</li> </ul>	p. 7 p. 6

### Karaoke function

	Symptom	Possible Causes	Reference Page
Audio	16. Sound is not produced. 17. Sound is distorted. 18. The vocals are not produced when an audio multiplex disc is played. 19. The GUIDE VOCAL volume cannot be adjusted. 20. The vocal volume is reduced when the <b>ONE-TOUCH KARAOKE</b> button is pressed.	<ul style="list-style-type: none"> <li>● The <b>NORMAL/KARAOKE/AUX INPUT</b> selector is set to AUX.</li> <li>● The <b>ATTENUATOR</b> switch is set to OFF.</li> <li>● The <b>NORMAL/KARAOKE/AUX INPUT</b> selector is not set to KARAOKE.</li> <li>● The <b>ONE-TOUCH GUIDE VOCAL</b> button is not switched on.</li> <li>● The <b>GUIDE VOCAL volume</b> control is set to the minimum position.</li> <li>● The <b>NORMAL/KARAOKE/AUX INPUT</b> selector is set to NORMAL.</li> <li>● The <b>ONE-TOUCH GUIDE VOCAL</b> button is not switched on.</li> <li>● The volume of vocals which are not located in the center position cannot be reduced.</li> </ul>	p. 13 p. 8, 9 p. 13 p. 16 p. 16
Operation	21. The player does not pause after having played a track. 22. The player pauses automatically. 23. The karaoke controls such as the KEY CONTROL, microphone inputs and ONE-TOUCH KARAOKE cannot be operated. 24. The KEY CONTROL and ONCE MORE cannot be operated from the microphone.	<ul style="list-style-type: none"> <li>● The <b>NORMAL/KARAOKE/AUX INPUT</b> selector is set to NORMAL or AUX.</li> <li>● The <b>SINGLE PLAY</b> button is not switched on.</li> <li>● The <b>SINGLE PLAY</b> button is pressed to on.</li> <li>● The <b>NORMAL/KARAOKE/AUX INPUT</b> selector is set to NORMAL.</li> <li>● The microphone is not connected to the MIC CONTROL jack. The switch on the microphone is not on.</li> </ul>	p. 15 p. 13

### Scoring function

	Symptom	Possible Causes	Reference Page
Operation	25. ONE-TOUCH KARAOKE, Vocal Partner, programming, repeating and surround functions cannot be used. 26. The scoring mode cannot be activated. 27. The scoring is not accurate.	<ul style="list-style-type: none"> <li>● These functions are not available in scoring.</li> <li>● The <b>NORMAL/KARAOKE/AUX INPUT</b> selector is not set to KARAOKE.</li> <li>● The <b>SCORING NORMAL</b> or <b>COMPETITION</b> button is not switched on.</li> <li>● The notes in your vocals may sometimes not be sampled accurately depending on the disc type or the tune.</li> <li>● If you sing during parts with no vocals, it is counted in scoring and the score will be degraded.</li> </ul>	p. 18, 19

#### CAUTION:

Abnormal functioning of this unit may be caused by static electricity, or other external interference. To restore normal operation, unplug the AC power cord and then plug it in again.

### When troubles occur:

When some troubles occur during use of the player, the following display (service number) appears on the display window of the player and the TV screen. If you experience this kind of trouble, follow the "Remedy" below.

#### Display window of the player

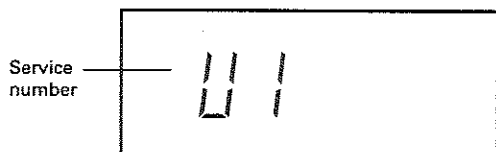

#### TV screen

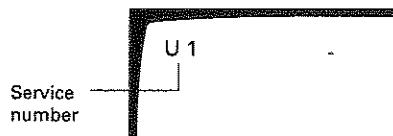

Service number	Condition of the player	Remedy
U 1 U 2	<ul style="list-style-type: none"> <li>The disc is not loaded properly on the disc table. Or, the disc is dirty.</li> </ul>	<ul style="list-style-type: none"> <li>Reload a disc along the disc guide groove on the disc table.</li> <li>Wipe the disc with a soft cloth. Open the disc table and press ► again.</li> </ul>
F 5  P 2 L 3 E 4	<ul style="list-style-type: none"> <li>Two discs are loaded on the disc table. Or, the disc is dirty.</li> </ul> <p>(The displayed number after P, F, L, and E differs depending on the condition of the player.)</p>	<ul style="list-style-type: none"> <li>Load only one disc on the disc table.</li> <li>Wipe the disc with a soft cloth.</li> <li>Open the disc table and press ► again. If the same service number is displayed, the player is in abnormal condition. When requesting servicing, please mention the displayed number on the display window of the player or on the TV screen (for example, 'service number E 4').</li> </ul>
H 0 H 1 H 2	<ul style="list-style-type: none"> <li>The player is in abnormal condition.</li> </ul>	<ul style="list-style-type: none"> <li>When requesting servicing, please mention the displayed number on the display window of the player or on the TV screen (for example, 'service number H 1').</li> </ul>

# SPECIFICATIONS

## General

System .....	LaserVision Disc system and Compact Disc digital audio system
Laser .....	Semiconductor laser wavelength 780 nm
Power requirements	
CLD-2750K .....	AC 110 - 127/220 - 240 V 50/60 Hz
CLD-1750K .....	AC 110 - 240 V, 50/60 Hz
Power consumption	
CLD-2750K .....	36 W
CLD-1750K .....	31 W
Weight	
CLD-2750K .....	6.7 kg
CLD-1750K .....	6.0 kg
Dimensions	
CLD-2750K .....	420 (W) x 410 (D) x 132 (H) mm
CLD-1750K .....	420 (W) x 390 (D) x 132 (H) mm
Operating temperature .....	+5 °C ~ +35 °C
Operating humidity .....	5 % ~ 85 % (There should be no condensation of moisture.)

## Video characteristics (two pairs)

Format .....	NTSC specifications
Video output	
Level .....	1 Vp-p nominal, sync. negative, terminated
Impedance .....	75 Ω unbalanced
Jack .....	RCA jack

## Audio characteristics (two pairs)

Output level	
During analog audio output .....	200 mVrms (1 kHz, 40 %)
During digital audio output .....	200 mVrms (1 kHz, -20 dB)
Jacks .....	Both RCA jacks
Number of channels .....	2 (Stereo)

## Other terminals

Control input/output .....	Both miniature jacks
AUX .....	RCA jacks
VHF adapter output (Video/Audio) .....	Both RCA jacks with DC jack

## Accessories

Remote control unit .....	1
Size "AAA" (IEC R03) dry cell batteries .....	2
Video cord .....	1
Audio cord .....	1
Power cord .....	1
Operating instructions .....	1
Warranty card .....	1

## NOTE:

The specifications and design of this product are subject to change without notice, due to improvement.

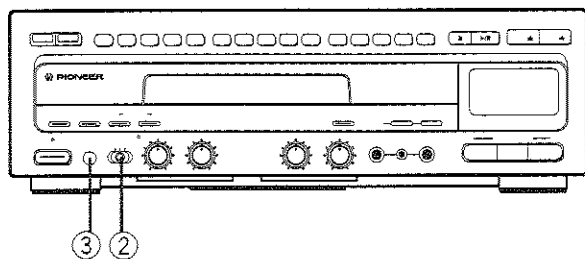

### About DEMO mode

The demonstration mode allows to see how the SCORING NORMAL and COMPETITION functions score vocals.

1. Turn on the power of the TV connected to this player.
  - Set the input selector of the TV to the player input (VTR, VCR, VD, etc.).
2. Set the NORMAL/KARAOKE/AUX INPUT selector to the KARAOKE position.
3. Turn on the power of the player by pressing the POWER button.

### To cancel DEMO mode

- Press one of the operation buttons on this player. The display of DEMO mode is cancelled.
- In step 2, if the NORMAL/KARAOKE/AUX INPUT selector is set to the NORMAL position and the power is turned on, the player will not enter DEMO mode.

When using the Projection Monitor, do not leave the DEMO display on the screen for an extended period of time. The TV screen may be damaged.

### Acerca del modo DEMO

El modo de demostración le permite ver cómo puntúa su voz en las funciones SCORING NORMAL o COMPETITION.

1. Conecte la alimentación del televisor conectado a este reproductor.
  - Ponga el selector de entrada del televisor en la posición correspondiente a la entrada del reproductor (VTR, VCR, VD, etc.).
2. Ponga el selector NORMAL/KARAOKE/AUX INPUT en la posición KARAOKE.
3. Conecte la alimentación del reproductor pulsando el botón POWER.

### Para cancelar el modo DEMO

- Pulse uno de los botones de operación de este reproductor. La visualización del modo DEMO se cancelará.
- En el paso 2, si se pone el selector NORMAL/KARAOKE/AUX INPUT en la posición NORMAL y se conecta la alimentación, el reproductor no entrará en el modo DEMO.

Cuando utilice el monitor de proyección, no deje la visualización DEMO en la pantalla durante mucho tiempo. La pantalla del televisor podría estropearse.

### 有關示範〔DEMO〕模式

示范模式讓您能夠看得到評分方式 SCORING NORMAL 和 COMPETITION 如何測試您的歌聲的功能。

1. 將與本機連接著的電視機之電源開關打開。
  - 將電視機的輸入選擇開關設定至放音輸入〔VTR, VCR, VD 等〕
2. 將普通／卡拉OK／外部輸出〔NORMAL/KARAOKE/AUX INPUT〕選擇鍵設定至 KARAOKE 位置。
3. 按電源開關鍵 POWER 將機器的電源打開。

### 取消示范〔DEMO〕模式

- 按下本機的操作按鍵之一，示范〔DEMO〕模式的顯示便被取消。
- 在第 2 步驟中，如果普通／卡拉OK／外部輸出〔NORMAL/KARAOKE/AUX INPUT〕選擇鍵設定至 NORMAL 位置，且電源為開的狀態下，機器將不會進入示范〔DEMO〕模式。

當使用投影監視器時，請勿將 DEMO 長時間地顯示于顯示屏上。以防止電視屏受到損害。

**LaserDisc** is a trademark of Pioneer Electronic Corporation.

**LaserDisc** es una marca registrada de Pioneer Electronic Corporation.

**LaserDisc** 是先鋒電子株式會社的商標。

Published by Pioneer Electronic Corporation.  
Copyright © 1995 Pioneer Electronic Corporation.  
All rights reserved.

**PIONEER ELECTRONIC CORPORATION** 4-1, Meguro 1-Chome, Meguro-ku, Tokyo 153, Japan

**PIONEER ELECTRONICS [USA] INC.** P.O. BOX 1540, Long Beach, California 90801-1540

**PIONEER ELECTRONICS OF CANADA, INC.** 300 Allstate Parkway, Markham, Ontario L3R 0P2, Canada

**PIONEER ELECTRONICS [EUROPE] N.V.** Haven 1087, Keetberglaan 1, 9120 Melsele, Belgium TEL: 03/570.05.11

**PIONEER ELECTRONICS AUSTRALIA PTY. LTD.** 178-184 Boundary Road, Braeside, Victoria 3195, Australia, TEL: [03] 580-9911

**PIONEER ELECTRONICS DE MEXICO S.A. DE C.V.** Augusto Rodin No.128 PB Col. San Juan Mixcoac Mexico D.F. CP.03730 TEL: 52-5-598-3950