

Operating Instructions

CD CDV LD PLAYER

CLD-3090

CLD-3390

LaserDisc

NTSC

COMPACT
disc
DIGITAL AUDIO

L
LASER DISC

- This player does not apply to business use, and CD-ROM/CD graphic discs cannot be played with this player.

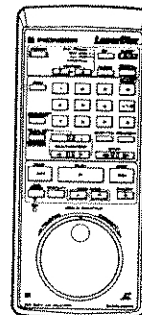
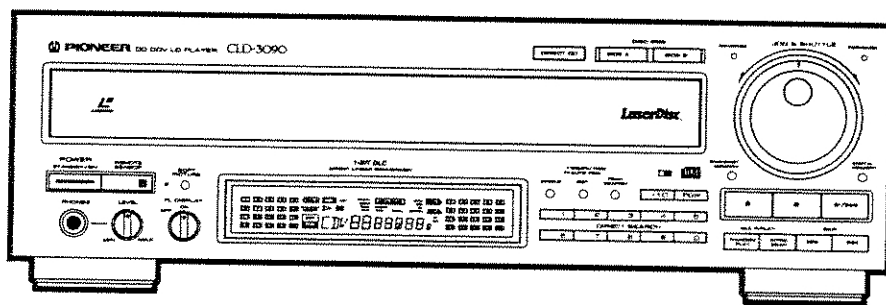

Thank you for buying this Pioneer product. Please read through these operating instructions so you will know how to operate your model properly. After you have finished reading the instructions, put them away in a safe place for future reference. In some countries or regions, the shape of the power plug and power outlet may sometimes differ from that shown in the explanatory drawings. However, the method of connecting and operating the unit is the same.

WARNING: TO PREVENT FIRE OR SHOCK HAZARD, DO NOT EXPOSE THIS APPLIANCE TO RAIN OR MOISTURE.

IMPORTANT NOTICE

[For U.S. and Canadian models]

The serial number for this equipment is located on the rear panel. Please write this serial number on your enclosed warranty card and keep it in a secure area. This is for your security.

[For Canadian model]

CAUTION: TO PREVENT ELECTRIC SHOCK DO NOT USE THIS (POLARIZED) PLUG WITH AN EXTENSION CORD, RECEPTACLE OR OTHER OUTLET UNLESS THE BLADES CAN BE FULLY INSERTED TO PREVENT BLADE EXPOSURE.

ATTENTION: POUR PREVENIR LES CHOCS ELECTRIQUES NE PAS UTILISER CETTE FICHE POLARISEE AVEC UN PROLONGATEUR, UNE PRISE DE COURANT OU UNE AUTRE SORTIE DE COURANT, SAUF SI LES LAMES PEUVENT ETRE INSEREES A FOND SANS EN LAISSER AUCUNE PARTIE A DECOUVERT.

LINE VOLTAGE SELECTOR SWITCH

Only multi-voltage models are provided with this switch. U.S., Canadian, European, U.K., and Australian models are not provided with this switch.

The line voltage selector switch is located on the rear panel of this player. Before your player is shipped from the factory, the switch is set to the power requirements of the player's destination. Check that it is set properly before plugging the power cord into the outlet. If the voltage is not properly set or if you move to an area where the voltage requirements differ, adjust the selector switch as follows:

Use a medium-sized (flat blade) screwdriver. Insert the tip of the screwdriver into the groove of the selector switch and turn it to set the player to the power voltage of your area.

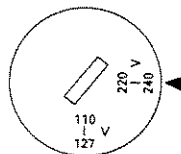

Set the selector so that arrow points power voltage of your area (Figure shows arrow pointing to 220 - 240 volts.)

PIONEER
The Art of Entertainment

IMPORTANT



The lightning flash with arrowhead, within an equilateral triangle, is intended to alert the user to the presence of uninsulated "dangerous voltage" within the product's enclosure that may be of sufficient magnitude to constitute a risk of electric shock to persons.

CAUTION
RISK OF ELECTRIC SHOCK
DO NOT OPEN

CAUTION:
TO PREVENT THE RISK OF ELECTRIC SHOCK, DO NOT REMOVE COVER (OR BACK). NO USER-SERVICEABLE PARTS INSIDE. REFER SERVICING TO QUALIFIED SERVICE PERSONNEL.



The exclamation point within an equilateral triangle is intended to alert the user to the presence of important operating and maintenance (servicing) instructions in the literature accompanying the appliance.

SAFETY INSTRUCTIONS

READ INSTRUCTIONS — All the safety and operating instructions should be read before the appliance is operated.

RETAIN INSTRUCTIONS — The safety and operating instructions should be retained for future reference.

HEED WARNINGS — All warnings on the appliance and in the operating instructions should be adhered to.

FOLLOW INSTRUCTIONS — All operating and use instructions should be followed.

CLEANING — Unplug this video product from the wall outlet before cleaning. Do not use liquid cleaners or aerosol cleaners. Use a damp cloth for cleaning.

ATTACHMENTS — Do not use attachments not recommended by the video product manufacturer as they may cause hazards.

WATER AND MOISTURE — Do not use this video product near water — for example, near a bathtub, wash bowl, kitchen sink, or laundry tub, in a wet basement, or near a swimming pool, etc.

ACCESSORIES — Do not place this video product on an unstable cart, stand, tripod, bracket, or table. The video product may fall, causing serious injury to a child or adult, and serious damage to the appliance. Use only with a cart, stand, tripod, bracket, or table recommended by the manufacturer, or sold with the video product. Any mounting of the appliance should follow the manufacturer's instructions, and should use a mounting accessory recommended by the manufacturer.

CART — An appliance and cart combination should be moved with care. Quick stops, excessive force, and uneven surfaces may cause the appliance and cart combination to overturn.



VENTILATION — Slots and openings in the cabinet are provided for ventilation and to ensure reliable operation of the video product and to protect it from overheating. These openings must not be blocked or covered. They should never be blocked by placing the video product on a bed, sofa, rug, or other similar surface. This video product should never be placed near or over a radiator or heat register. This video product should not be placed in a built-in installation such as a bookcase or rack unless proper ventilation is provided or the manufacturer's instructions have been adhered to.

POWER SOURCES — This video product should be operated only from the type of power source indicated on the marking label. If you are not sure of the type of power supply to your home, consult your appliance dealer or local power company. For video products intended to operate from battery power, or other sources, refer to the operating instructions.

POWER-CORD PROTECTION

Power supply cords should be routed so that they are not likely to be walked on or pinched by items placed upon or against them. Pay particular attention to cords at plugs, convenience receptacles, and the point where they exit from the appliance.

POLARIZATION — This video product is equipped with a polarized alternating current line plug (a plug having one blade wider than the other). This plug will fit into the power outlet only one way. This is a safety feature. If you are unable to insert the plug fully into the outlet, try reversing the plug. If the plug should still fail to fit, contact your electrician to replace your obsolete outlet. Do not defeat the safety purpose of the polarized plug.

LIGHTNING — For added protection for this video product receiver during a lightning storm, or when it is left unattended and unused for long periods of time, unplug it from the wall outlet and disconnect the antenna or cable system. This will prevent damage to the video product due to lightning and power-line surges.

POWER LINES — An outside antenna system should not be located in the vicinity of overhead power lines or other electric light or power circuits, or where it can fall into such power lines or circuits. When installing an outside antenna system, extreme care should be taken to keep from touching such power lines or circuits as contact with them might be fatal.

OVERLOADING — Do not overload wall outlets and extension cords as this can result in the risk of fire or electric shock.

OBJECT AND LIQUID ENTRY — Never push objects of any kind into this video product through openings as they may touch dangerous voltage points or short-out parts that could result in a fire or electric shock. Never spill liquid of any kind on the video product.

SERVICING — Do not attempt to service this video product yourself as opening or removing covers may expose you to dangerous voltage or other hazards. Refer all servicing to qualified service personnel.

DAMAGE REQUIRING SERVICE

Unplug this video product from the wall outlet and refer servicing to qualified service personnel under the following conditions:

- When the power-supply cord or plug is damaged.
- If liquid has been spilled, or objects have fallen into the video product.
- If the video product has been exposed to rain or water.
- If the video product does not operate normally by following the operating instructions. Adjust only those controls that are covered by the operating instructions. Improper adjustment of other controls may result in damage and will often require extensive work by a qualified technician to restore the video product to its normal operation.
- If the video product has been dropped or the cabinet has been damaged.
- When the video product exhibits a distinct change in performance — this indicates a need for service.

REPLACEMENT PARTS — When replacement parts are required, be sure the service technician has used replacement parts specified by the manufacturer or having the same characteristics as the original part. Unauthorized substitutions may result in fire, electric shock or other hazards.

SAFETY CHECK — Upon completion of any service or repairs to this video product, ask the service technician to perform safety checks to determine that the video product is in proper operating condition.

OUTDOOR ANTENNA GROUNDING — If an outside antenna is connected to the antenna terminal, be sure the antenna system is grounded so as to provide some protection against voltage surges and built-up static charges.

In the U.S.A. section 810 of the National Electrical Code, ANSI/NFPA No. 70-1984, provides information with respect to proper grounding of the mast and supporting structure, grounding of the lead-in wire to an antenna discharge unit, size of grounding conductors, location of antenna-discharge unit, connection to grounding electrodes, and requirements for the grounding electrode.

See Fig. A.

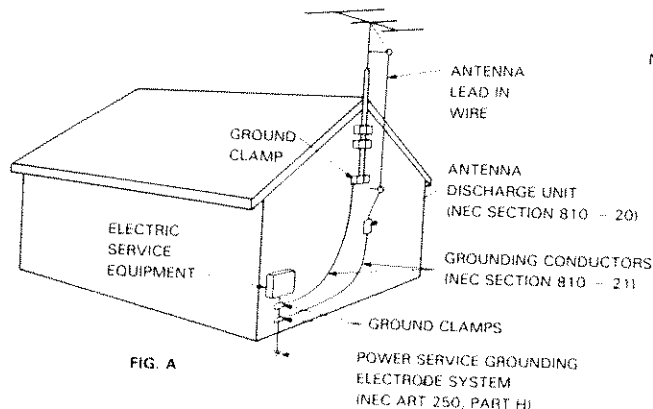

FIG. A

CAUTION

- Use of controls or adjustments or performance of procedures other than those specified herein may result in hazardous radiation exposure.
- The use of optical instruments with this product will increase eye hazard.

INFORMATION TO USER [FOR U.S. MODEL]

This equipment generates and uses radio frequency energy and if not installed and used properly, that is, in strict accordance with the manufacturer's instructions, may cause interference to radio and television reception. It has been type tested and found to comply with the limits for a Class B computing device in accordance with the specifications in Subpart J of Part 15 of FCC Rules, which are designed to provide reasonable protection against such interference in a residential installation. However, there is no guarantee that interference will not occur in a particular installation.

If this equipment does cause interference to radio or television reception, which can be determined by turning the equipment off and on, the user is encouraged to try to correct the interference by one or more of the following measures:

- reorient the receiving antenna
- relocate this equipment with respect to the receiver
- move this equipment away from the receiver
- plug this equipment into a different outlet so that equipment and receiver are on different branch circuits

If necessary, the user should consult the dealer or an experienced radio/television technician for additional suggestions. The user may find the following booklet prepared by the Federal Communications Commission helpful:

'How to Identify and Resolve Radio-TV Interference Problems'

This booklet is available from the US Government Printing Office, Washington, D.C., 20402, Stock No. 004-000-00345-4

The above instructions apply only to units which will be operated in the United States

- This player may be used with LaserVision Discs, Compact Discs, and Compact Discs with Video bearing the following symbols:

(LASERDISC SYSTEM)/(LaserVision Disc)*



This is the unified symbol mark of LASERDISC (LaserVision videodisc).

- * LaserVision players and discs which bear this symbol and use the same television system, are mutually compatible.

(Compact Disc)



(**CD VIDEO SYSTEM)



(3-inch Compact Disc)



- ** A Digital Sound with Multi Audio Discs (CD VIDEO LD) are referred to as CD Video discs. CD Video discs are recorded with subcodes, which are the non-audio recordings of TOC data such as track numbers, index numbers, etc. However, there are some discs without these marks.

[For Canadian model]

This digital apparatus does not exceed the Class B limits for radio noise emissions from digital apparatus set out in the Radio Interference Regulations of the Canadian Department of Communications.

Only one disc can be loaded at any one time. Loading a LaserVision Disc, a Compact Disc, a 3" Compact Disc or a Compact Disc with Video on top of one another may result in breakdown, or in scratching of the discs. Please only load one disc at a time.

This player is to be used exclusively with the NTSC color system. Please use NTSC LaserVision Disc or NTSC Compact Disc with Video only. PAL and SECAM system discs cannot be used with this player.

ATTENTION

At the rear panel, there is a red transit screw used for when the player is transported. Before using the player, turn this transit screw counterclockwise and remove.

If the transit screw is still in place and the power is turned on, "RELEASE TRANSIT SCREW" will be displayed on the screen.

If this happens, turn off the power. After the "OFF" indicator stops flashing, remove the transit screw.

Retain this screw as it will be necessary when the unit is to be transported. Also, before transporting the player, take out the disc, close the disc table, turn off the power, and after the "OFF" indicator stops flashing, unplug the power cord from the outlet. Then install the transit screw by turning it clockwise. Fasten the screw securely.

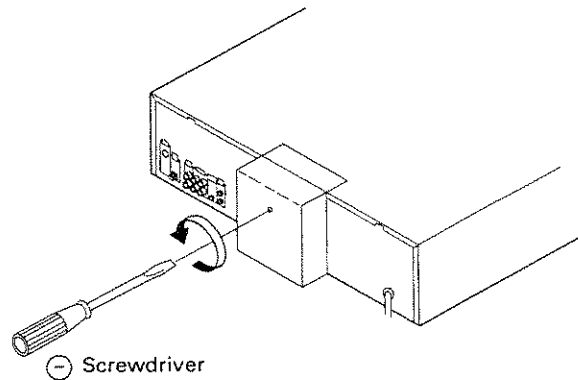

CONTENTS

<p>Accessories 5</p> <p>Precautions 6</p> <p>Features and Functions of the player 7</p> <p>Types of Discs that can be played with this Unit 8</p> <p>Care of Discs 10</p> <p>Connections 11</p> <p>Names and Functions of Remote Control Unit Components 15</p> <p>Names and Functions of Front Panel Components 16</p> <p>Display Switching 18</p> <p>To Play an LD, CDV or CD 20</p> <p>To Search for a Particular Passage 24</p> <p>To Search for a Particular Chapter/Track (Chapter (Track) Search/Chapter (Track) Skip/Intro Scan) 25</p>	<p>To Search for a Particular Time/Frame (Time Number Search/Track Time Search/ABS Time Search/Frame Number Search) 26</p> <p>Convenient Function for Karaoke Play (Single Play) 27</p> <p>To Play All Chapters/Tracks in a Random Order (Random Playback) 27</p> <p>Extra Playback 28</p> <p>Particular Functions for CD (Direct CD/Peak Level Search) 31</p> <p>To Repeatedly Play a Desired Passage (Repeat Playback) 32</p> <p>To Play Only the Desired Scenes/Tracks (Program Playback) 34</p> <p>Programming Chapters/Tracks to be played back within a Specified Time Period (Compu Program/Auto Program Edit) 36</p> <p>Troubleshooting 37</p> <p>Specifications 41</p>
---	---

ACCESSORIES

When unpacking the player, first check to make sure that all of the accessories listed below are supplied.

- Remote control unit
- Size "AAA" (IEC R03) dry cell battery x 2

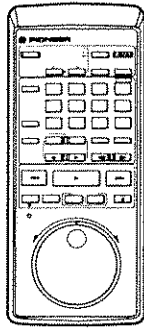
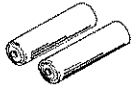

- Video cord (Pin plug ↔ Pin plug)
Use to connect the player to a color monitor etc.

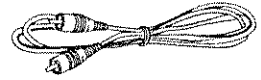

- Audio cord (Pin plug x 2 ↔ Pin plug x 2)
Use to connect the player to a stereo amplifier etc.

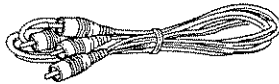

- Operating instructions
- Warranty card

INSERTING BATTERIES INTO THE REMOTE CONTROL UNIT

- 1 Open the battery compartment cover on the back of the remote control unit. The cover should open easily if you press on it with your thumb while sliding it in the direction of the arrow.
- 2 Take out the two accessory size "AAA" (IEC R03) dry cell batteries, and insert them into the battery compartment in accordance with the display (⊕, ⊖) inside the compartment.
- 3 Close the cover of the battery case.

Incorrect use of batteries may cause leakage or rupture.

Always be sure to follow these guidelines:

- A. Always insert batteries into the battery compartment correctly matching the positive (⊕) and negative (⊖) polarities, as shown by the display inside the compartment.
- B. Never mix new and used batteries.
- C. Batteries of the same size may have different voltages, depending on brand. Do not mix different brands of batteries.

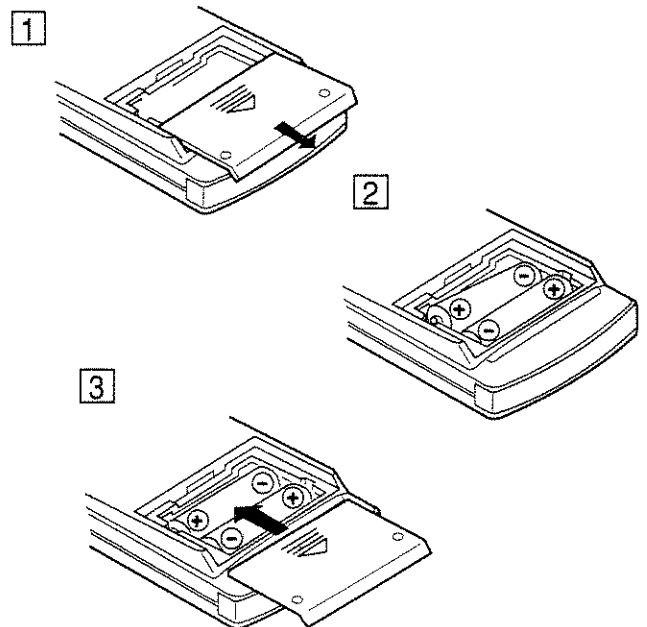

PRECAUTIONS

If it becomes necessary to transport or ship this unit in the future, be sure to first remove the disc (if present), retract the disc table to its closed position and turn the power off. After the "OFF" indicator stops blinking on the display, disconnect the power cord. Then tighten the transit screw.

INSTALLING THE PLAYER

- Place the player on a stable platform next to the television and stereo system to be used with the player.
- When using the player with a stereo system, your speakers should be placed away from your television (or TV monitor).
- Do not place heavy objects such as a television or TV monitor on top of the player.
- Do not place the player on top of your TV set or TV monitor. Also, keep the player away from devices such as cassette decks which are sensitive to magnetic fields.

When FM or AM stations are being received, signal noise may be generated if the player is turned on. Turn off the player when not in use. Also, if there is signal noise when receiving radio stations with an indoor antenna, adjust the position or direction of the antenna.

INSTALL THE PLAYER IN A WELL VENTILATED PLACE AWAY FROM HEAT AND HUMIDITY

Do not install the player in a location subject to direct sunlight, or near a stove or radiator etc. This could adversely affect the cabinet and internal components. Also avoid installing the player in a humid or dusty location. This could result in a malfunction or accident. Do not install near a cookstove where the player could be affected by smoke, steam, or heat.

AVOID SOURCES OF HEAT

Do not put the player on sources of heat, such as an amplifier. When installing with audio components on a rack, avoid components that generate heat, by placing the player below such components where there is adequate ventilation and not much dust. Avoid placing the player on surfaces such as shaggy carpets, beds, and sofas which may block ventilation under the player and cause damage.

CAUTIONS FOR AUTOMATIC LOADING OPERATIONS

Since this player has an automatic loading construction, use the button on the player or the remote control unit for opening and closing of the disc table. To avoid damage, be careful not to apply any force to the moving disc table.

STRIPE PATTERNS APPEARING ON A TV PROGRAM

Stripe patterns may appear during a TV program if the player unit is turned on, depending on the quality of reception of the TV station. This is neither a malfunction of the television nor the player. If stripes appear while watching the TV, or when watching the TV for long periods of time, turn the player off.

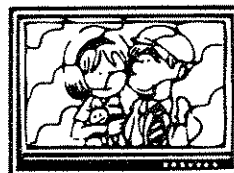

CONDENSATION

Moisture will form in the operating section of the player if the player is brought from cool surroundings into a warm room or if the temperature of the room rises suddenly. When this happens, player's performance will be impaired.

To prevent this, let the player stand in its new surroundings for about an hour before switching it on, or make sure that the room temperature rises gradually.

The same, symptoms of condensation may be caused during summer, if the player is exposed to the breeze from an air conditioner. In such cases change the location of the player.

POWER-CORD CAUTION

Handle the power cord by the plug. Do not pull out the plug by tugging the cord and never touch the power cord when your hands are wet as this could cause a short circuit or electric shock. Do not place the unit, a piece of furniture, etc., on the power cord, or pinch the cord. Never make a knot in the cord or tie it with other cords. The power cords should be routed such that they are not likely to be stepped on. A damaged power cord can cause fire or give you an electrical shock. Check the power cord once in a while. When you find it damaged, ask your nearest PIONEER authorized service center or your dealer for a replacement.

CLEANING CARE

Use a soft, dry cloth for cleaning. For stubborn dirt, soak the cloth in a weak detergent solution; wring well first and wipe. Use a dry cloth to wipe it dry. Do not use any volatile agents such as benzine or paint thinner, as it may damage the surface of the player.

Abnormal functioning of this unit may be caused by lightning, static electricity, or other external interference. To restore normal operation, turn the power off and then on again, or unplug the AC power cord and then plug it in again.

FEATURES AND FUNCTIONS OF THE PLAYER

LD (LaserVision Disc) Playback Functions

Alpha-Turn System – Two-Side Playback

With this function, both sides of a two-sided LD can be played consecutively, eliminating the need to turn the disc over when the first side is completed.

Three Types of A Side ← → B Side Continuous Playback Programs

Through the use of the Alpha-Turn system, programs which go from side A to side B or from side B to side A can be freely created.

With the Chapter Program function, up to 24 chapters can be programmed for playback in any desired sequence.

Special Play Functions Utilizing Digital Video Memory

The video system's jitter compensation circuit uses a digital TBC which has a wide compensation range and theoretically no signal degradation, resulting in high picture quality. Moreover, an 8-bit digital memory circuit is incorporated, enabling you to enjoy a variety of special play functions with high picture quality, even with CLV discs.

One-Song Pause Function – Great for Karaoke

By pressing the SINGLE button and selecting a tune, the player automatically enters pause mode when the selected tune finishes playing. If you designate another tune, that tune is played and then the player pauses again.

Random Playback (only discs with TOC)

All chapters of one side of a disc can be played in random order.

Repeat Playback

Eight repeat modes - Memory Repeat, 1-chapter Repeat, One-side Repeat, All side Repeat, Section Repeat, Program Repeat, Random Repeat and Program Random Repeat - are available. (With discs having no TOC, Random Repeat cannot be carried out.)

CD (Compact Disc) Playback Functions

Program Playback

Up to 24 tracks can be selected from a disc and played in any desired order.

Random Playback

All tracks on a disc can be played in random order.

Repeat Playback

Seven repeat modes - Memory Repeat, 1-Track Repeat, All-track Repeat, Section Repeat, Program Repeat, Random Repeat and Program Random Repeat - are available.

Auto Program Editing/Compu Program Editing

The player automatically selects and programs the tracks which can be played back within a specified time.

Direct CD function

Once CD DIRECT on the front panel is pressed, time for starting play becomes shorter. In addition, since the picture circuit does not function, the player eliminates the interference between signals and reproduces more pure sound.

Peak Search function

The player detects the peak level of a CD. This is a convenient function for recording CD play onto the cassette deck.

CDV (Compact Disc with Video) Playback functions

- * The video part (the section of the disc containing both video and audio) is played first.

Video Part:

The same functions available for LD (CLV) playback can be used.

Audio Part:

The same functions available for CD playback can be used.

Other Features

Last Memory Function

With this function, if you turn the power switch off during playback of an LD, a playback position slightly ahead of the last frame to be played is stored in memory (last memory). When the power is turned back on, playback begins from the memorized position by pressing ►▶◀◀.

Auto Loading and Automatic Disc Discrimination Functions

This unit has a built-in motor-driven auto loading mechanism which automatically opens and closes the disc table and makes disc loading easy.

Also, once a disc is placed on the table and the table is retracted into the player, the player automatically detects which type of disc (LD, CD, or CDV) is loaded.

1-Bit DLC D/A Converters

(D/A Converters with Double-Step Noise Shaping)

D/A converters are devices for transforming digital signals into analog signals. The D/A converter used in this player employs an advanced 1-bit conversion system. Compared to conventional converters, this system has the following advantages.

- Theoretically no zero cross distortion is generated.
- The system is free of non-linear distortion throughout the frequency range.
- High-precision operation can be obtained without adjustments.

With this type of conversion, there is no loss of music quality even at minute signal levels. Moreover, the noise shaping function necessary for 1-bit conversion is implemented using a double-step noise shaping system. This system carries out noise shaping once in the preliminary digital filter stage and then again in the D/A converter section, thus minimizing quantization noise and providing extremely high-precision conversion. Furthermore, two of these D/A converters are used independently for the left and right channels, realizing a high signal-to-noise ratio and excellent separation.





Compatibility with Many Disc Types and Sizes



In addition to conventional LDs (12-inch, 8-inch), CDs (5-inch), and CDV discs (5-inch), the player can play thin-type 8-inch LDs and 3-inch CD singles without an adapter.

TYPES OF DISCS THAT CAN BE PLAYED WITH THIS UNIT

This unit is a CD VIDEO SYSTEM (*1) compatible player which can play CDs, CDV discs, and LDs. The five disc types listed in the table below can be played with this unit.

*The marks shown in the left column are printed on the labels and jackets of the corresponding discs.

Mark	Disc	Size	Number of recorded sides	Audio recording system	Video recording system	Other
	CD (Compact Disc) Single	3-inch	One side	Digital (20 minutes max.)		TOC (*2)
	CD (Compact Disc)	5-inch	One side	Digital (74 minutes max.)		TOC
	CDV (CD with Video)	5-inch	One side	Digital (20 minutes max./ 5 minutes max.)	CLV (*3) (5 minutes max.)	TOC *
	CD VIDEO LD (*4)	12-inch, 8-inch	Two sides, one side	Digital/analog	CAV (*5), CLV	TOC **
	LD (LASERDISC/ LaserVision Disc)	12-inch, 8-inch	Two sides, one side	Digital/analog (*6) or analog only	CAV, CLV	

* There are some discs marked with the  mark instead of the  mark.

** There are some discs without the  mark.

LD GLOSSARY

Chapter number

Chapter numbers are used to indicate the boundaries of the sections on a disc, similar to the "chapters" in a book. If chapter numbers are recorded on a disc, it is so indicated on the jacket of the disc, etc. Chapter numbers can be used to search for desired chapters (Chapter Search).

Frame number

Frame numbers are the numbers assigned to each picture frame on a CAV (standard play) disc. Frame numbers can be used to search for desired frames (Frame Search).

Time number

Time numbers indicate the time elapsed from the beginning of a CLV (extended play) disc. Time numbers can be used to search for desired scenes (Time Search).

CDV/CD GLOSSARY

Track number

Track numbers indicate the boundaries of the sections, or "tracks", on a disc. Track numbers are assigned consistently throughout the audio part and video part of a CDV disc. Track numbers can be used to search for desired tracks (Track Search).

TOC (*2)

Every CD/CDV-type disc is provided with a section called TOC (Table Of Contents) at the beginning of the disc. The TOC section is just like the table of contents of a book, and contains information on the contents (number of tracks, playing time, etc.) of the disc.

- Some LD discs are also provided with a TOC section.

CD VIDEO SYSTEM (*1)

The CD VIDEO SYSTEM is the standard name for the "optical video disc with digital audio" system that encompasses both LDs and CDV discs.

The following mark is the standard mark for the CD VIDEO SYSTEM and is found on all players and discs which conform to the CD VIDEO SYSTEM format.

The following systems are included in the CD VIDEO SYSTEM:



- CDV (CD VIDEO CDV) discs
- LaserVision Discs (CD VIDEO LDs) containing digital sound with sub-codes
- Compatible players which can play CDs and CDV discs
- Compatible players which can play CDs, CDV discs, and LDs

CD VIDEO LDs (*4)

A CD VIDEO LD is an LD with digital audio which is encoded with sub-codes (data such as TOC and track number data, excluding audio and video signals).

LDs (LASERVISION DISCS)

With this unit, only play LaserVision discs which bear the following mark.

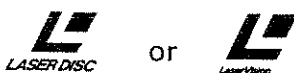

This mark is the standard mark for LaserVision video discs. Players and discs which bear the LaserVision mark are mutually compatible as long as they conform to the same television system.

Two types of standard LaserVision disc are available — standard play (CAV) (*5) discs and extended play (CLV) (*3) discs — which differ with respect to their signal recording systems.

CAV (*5) DISCS

The jackets and labels of these discs are marked with a "Standard Play Disc CAV" or "Standard Play" indication.

Frames are recorded on these discs at a ratio of one frame per disc revolution, and the discs are played at a fixed rotational speed (CAV = Constant Angular Velocity) of 1,800 rpm. This system is well suited to special playback modes such as still frame playback and multi-speed playback. One side of a CAV disc can have a playback time of up to 30 minutes (for a 12-inch disc), which is equivalent to 54,000 frames. Each frame — from frame 1 to frame 54,000 — is encoded with its own frame number.

* Playback time varies according to the contents of the disc.

CLV (*3) DISCS

The jackets and labels of these discs are marked with a "Extended Play Disc CLV" or "Extended Play" indication.

Signals are recorded on these discs at a constant linear velocity (CLV), and the rotational speed during playback varies from 1,800 rpm for the innermost track to 600 rpm for the outermost track. As a result, one side of a CLV disc can have a playback time of up to 60 minutes (for a 12-inch disc), which is twice as long as a standard play (CAV) disc. CLV discs are encoded with time numbers which correspond to the elapsed play time from the beginning of the disc.

* Playback time varies according to the contents of the disc.

LASERVISION DISCS WITH DIGITAL AUDIO (*6)

The jackets and labels of these discs bear the following mark.

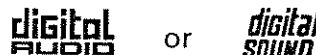

These are LaserVision discs which contain digital audio signals in addition to conventional analog audio signals. This feature allows the high image quality of LaserVision discs to be enjoyed together with the superior quality of digital sound. The digital and analog audio signals are recorded on the disc using different frequency bands.

LASERVISION MULTI AUDIO DISCS WITH DIGITAL AUDIO

The jackets and labels of these discs bear the following mark.

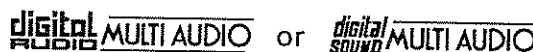

These are LaserVision discs in which the recorded digital and analog audio signals differ in content. This allows the user to enjoy two different audio soundtracks by switching between the digital and analog sound.

CDV (COMPACT DISC WITH VIDEO) DISCS

These are compact discs which also contain video signals. Of the total 25-minute playback time of a CDV disc, 20 minutes is encoded with conventional CD digital audio signals (the "audio part"). The remaining 5 minutes is encoded with both video and digital audio signals (the "video part").

CARE OF DISCS

How to hold discs

When loading or removing discs, try not to touch their playing surfaces.

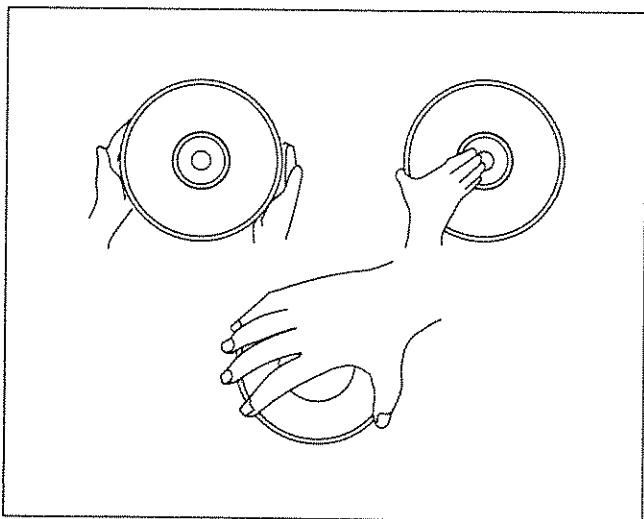

Cleaning

Fingerprints or other dirt on the disc may affect sound and picture quality.

To clean your discs, use a soft clean cloth to wipe them. If necessary, moisten a soft cloth with diluted neutral detergent to remove heavy dirt of fingerprints.

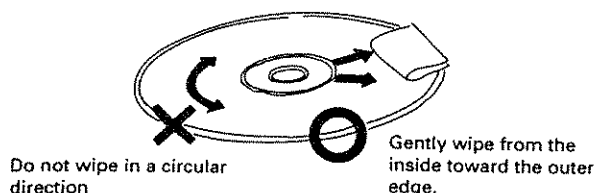

Discs may not be cleaned with record cleaning sprays, or static prevention sprays, etc. Also do not use volatile liquids such as benzine, or thinner, etc.

NEVER PLAY CRACKED OR WARPED DISCS.

■ The disc revolves on the player at a high speed when it is played. Never play a cracked, scratched or warped disc. This may damage the player or cause it to malfunction.

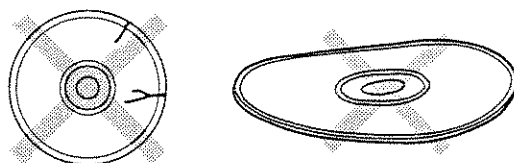

After using discs, store them upright

After playing a disc, always remove it from the player and return it to its jacket. Then store it standing upright away from heat and humidity.

- Store discs carefully. If you store discs at an angle, or stacked on top of each other, discs may become warped even when in their jackets.
- Do not leave discs in locations such as the seat of car, which may become excessively hot.

If an LD disc is warped...

If an LD disc is warped, put the disc into its protective envelope, and then place it between two flat plates of glass. Then place heavy books on top of the plates so that approximately 4 to 5 kgs (10 lbs) is applied. Leave the disc like this for a day or so. This may correct the warp.

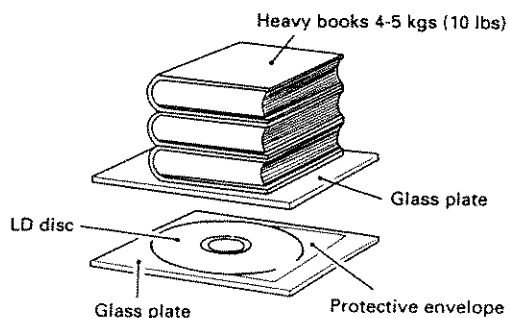

CAUTION WHEN USING THE DISC

All rights reserved.

Unauthorized public performance, broadcasting or copying is a violation of applicable laws.

CONNECTIONS

● Only televisions equipped with a video input can be connected to this unit.

USING TELEVISION WITH AUDIO AND VIDEO JACKS

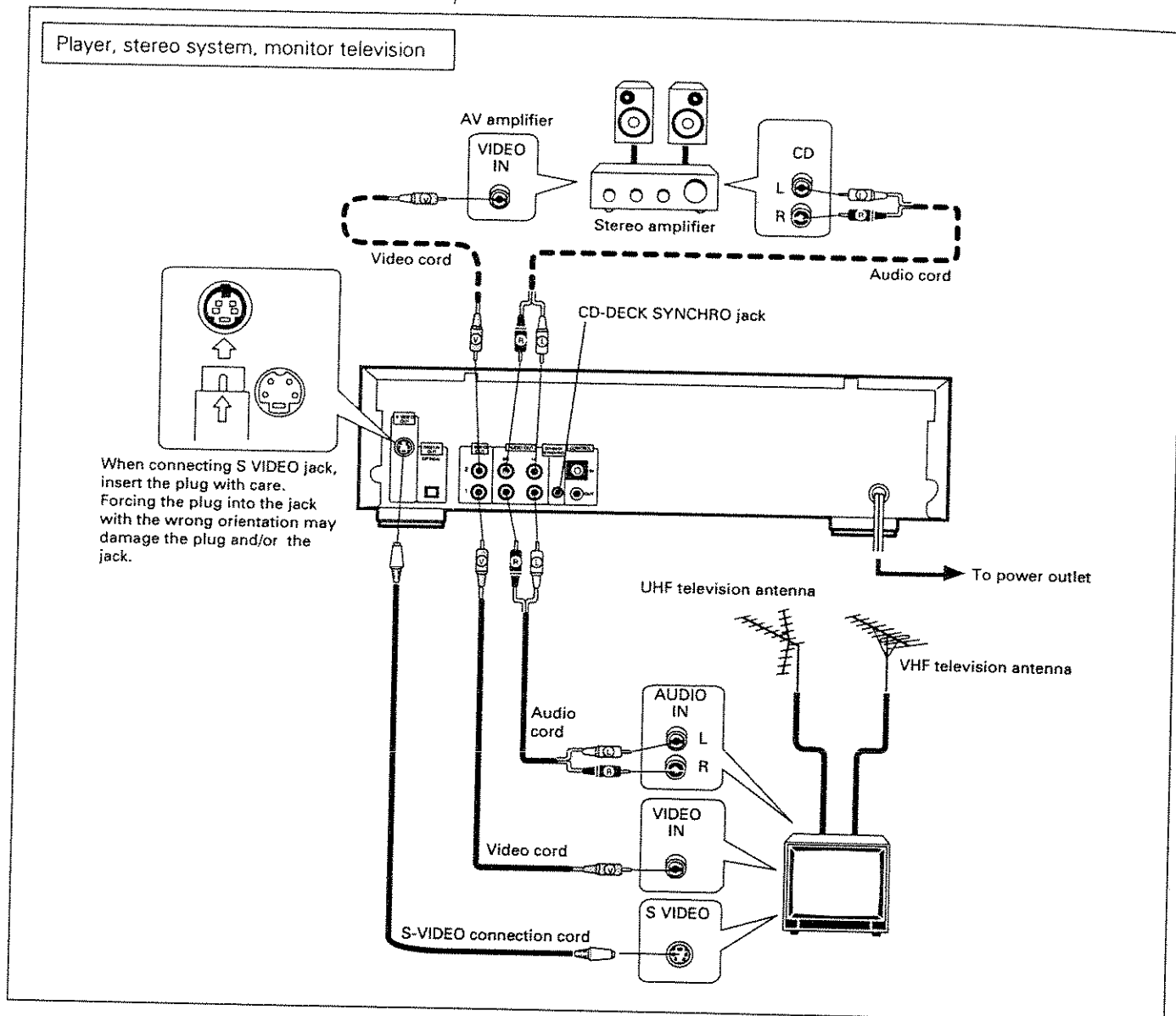

- Connect the VIDEO OUT jack of the player to the video input jack of the monitor television.
- Connect the AUDIO OUT jacks to the stereo amplifier AUX, CD, LD, VDP or other jacks, except the PHONO input jacks. The television speakers can also be used by connecting the television audio input jacks and the player AUDIO OUT jacks, however connection to a stereo amplifier is recommended to obtain superior audio playback quality for Compact Discs and LaserVision Discs. Do not change the television antenna and VCR connections.
- Connect the power cord to an AC wall outlet.
- Combined system control is possible when a Pioneer television and audio/video stereo receiver are connected. Refer to page 13 and 14 for an explanation of the connection procedure.

- When making connections to stereo amplifier equipped with a built-in D/A converter and an optical digital jack, refer to the connection instructions on the page 12.

CD-DECK synchro function

If you have a Pioneer cassette deck provided with the CD-Deck synchro function, connect the CD-DECK SYNCHRO jacks of the player and cassette deck. With this function, synchro recording can be carried out between player and deck.

- With CD as well as CDV and LD, the CD-Deck synchro recording can be carried out.
- For details on connections and operation, refer to the instruction manual supplied with the cassette deck.

Stereo amplifier connections

Connect the AUDIO OUT jacks of the player to the AUX, CD or LD input jacks of your stereo amplifier.

NOTE:

- Do not connect these terminals to your amplifier PHONO input jacks.

Connecting to an optical digital jack

This unit can be connected to an amplifier equipped with an optical digital jack.

1. Remove the protective dust cap from this unit's OPTICAL DIGITAL OUT jack.
 2. Use an optical fiber cable to connect OPTICAL DIGITAL OUT jack of this unit to the optical digital input jack of the amplifier.
- Align the plug of the optical fiber cable with the optical digital jack and fully insert the plug to make a secure connection.

Use a separately sold optical fiber cable for the optical digital jack connections. However, when making optical digital connections, the player can only be connected to an amplifier which uses the same type of optical transmission/reception module.

Precautions concerning use of optical fiber cables

- Fully insert the optical fiber cable plugs all the way into the jacks.
- Be careful not to fold or crimp the cable. When coiling an optical fiber cable for storage, make sure the diameter of the coil is 15 cm (6 inches) or larger.
- Use an optical fiber cable with a length of 3 m (10 feet) or less.
- Protect the optical fiber cable plugs from scratches and dust.
- When the unit is not connected using an optical fiber cable, be sure to keep the protective dust cap plugged into the optical digital output jack at all time.

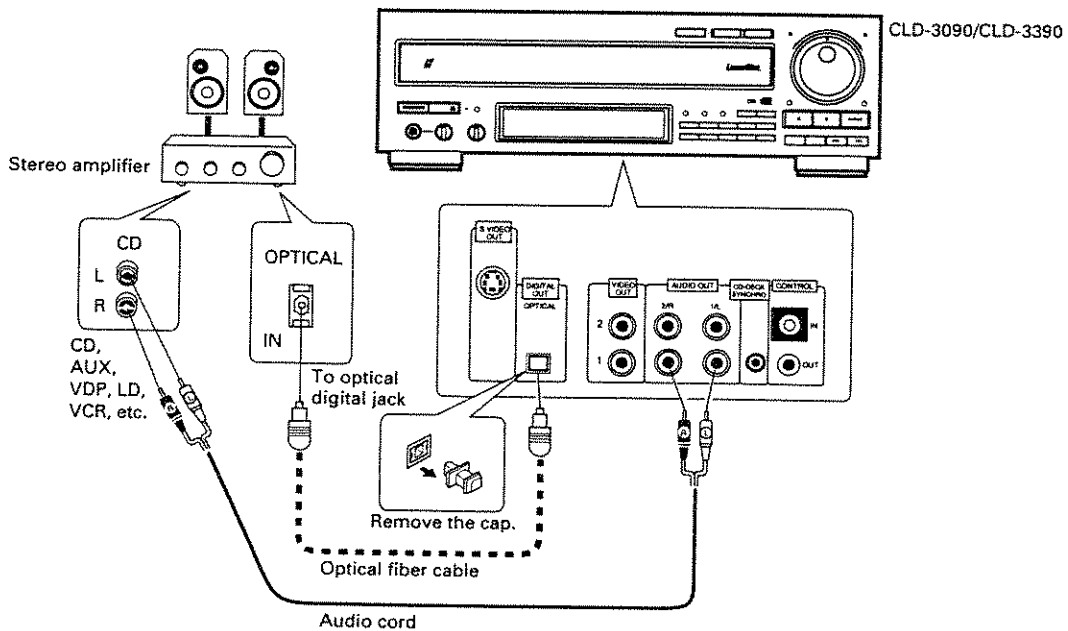

Plug the AC power cords of the player, stereo amplifier and TV set into an AC outlet.

When the power cord of this unit is connected to an AC outlet, power is supplied to the unit's internal memory (such as the last memory) even when the POWER switch is OFF. Therefore, be sure to connect the power cord directly to a wall outlet. If the power cord is connected to an outlet such as a switched outlet on an amplifier, the various memory contents will be erased whenever the amplifier's power switch is turned off.

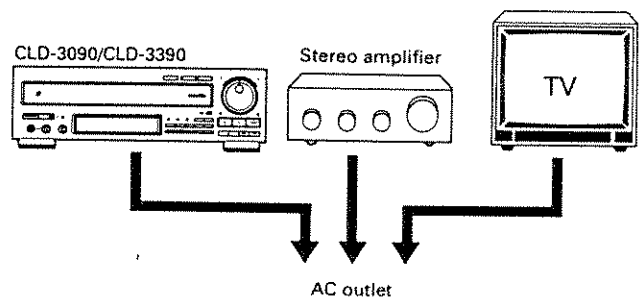

SYSTEM REMOTE CONTROL CONNECTION

WHEN COMBINED WITH OPTIONAL PIONEER PROJECTION MONITOR (or COMPONENT DISPLAY)

Connect the VIDEO OUT jack of the player to the video input jack of the projection monitor (or component display), and connect the AUDIO OUT jacks of the player to the audio input jacks of the projection monitor (or component display).

System Control

By connecting the CONTROL IN jack of the player to the remote jack of the projection monitor (or component display), the system can be controlled by the remote control unit of the player at the remote control sensor of the projection monitor (or component display).

- Use a commercially available cord with mini-plugs for the connection.

Please also refer to the operating instructions for the projection monitor (or component display).

NOTE:

When system control connections have been made, the player cannot be directly controlled by the remote control unit. To operate the player, aim the remote control unit at the projection monitor (or component display).

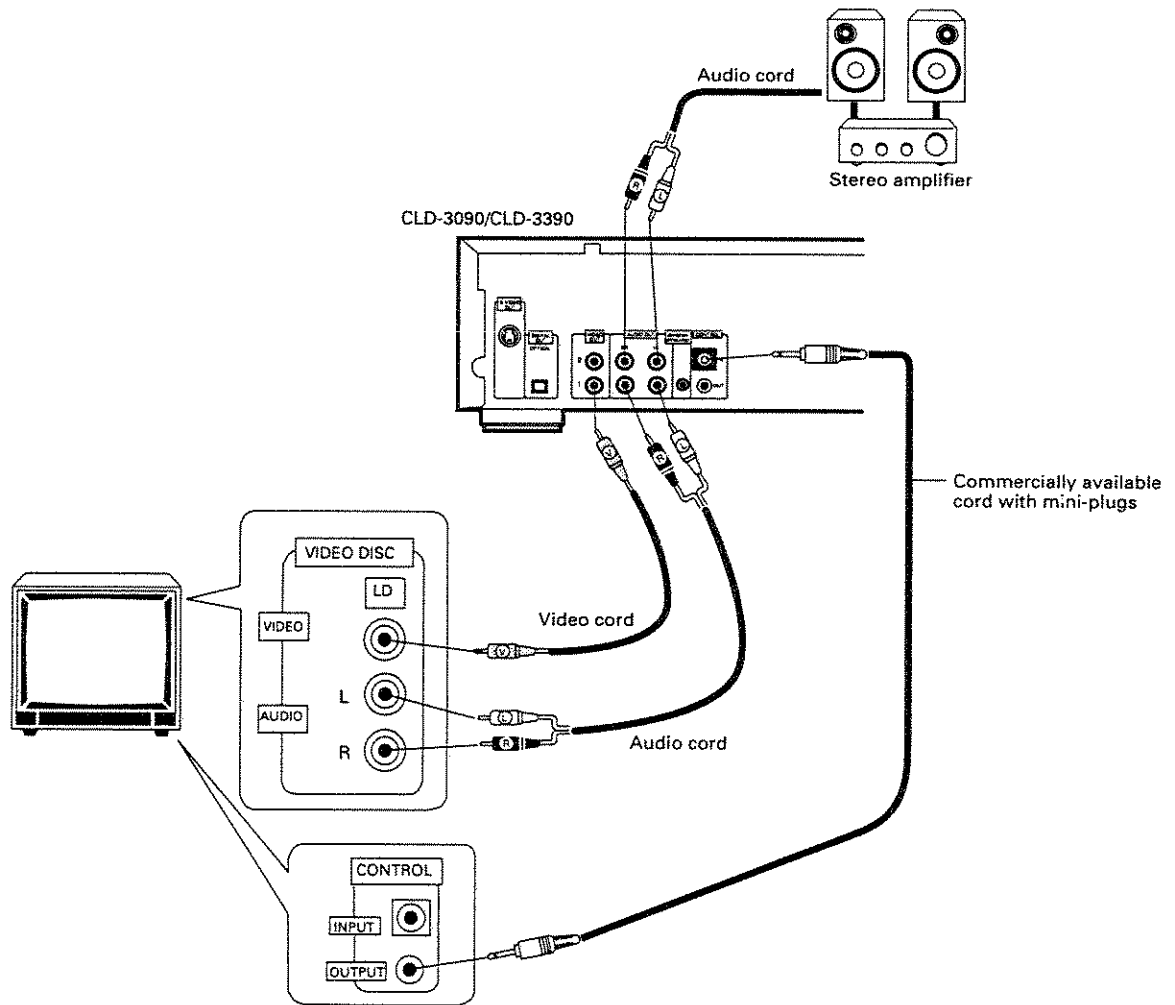

PERFORMING SYSTEM CONTROL WHEN THE PLAYER IS COMBINED WITH A PRODUCT THAT HAS THE SR MARK

System control can be performed when the player is combined with an optional AV control center, which can provide centralized control of Pioneer products with the SR mark.

Connect the VIDEO OUT jack of the player to the video disc video input jack of the AV control center and connect the AUDIO OUT jacks of the player to the audio input jacks of the AV control center.

Connect the CONTROL OUT jack of the AV control center to the CONTROL IN jack of the player using a commercially available cord with mini-plugs.

- For details concerning the connection and operation methods, please refer to the operating instructions for the AV control center.

NOTE:

- When a connecting cord has been connected to the CONTROL IN jack, direct control of the player with the remote control unit is not possible. Operate the player with the remote control unit by aiming it at the AV control center.

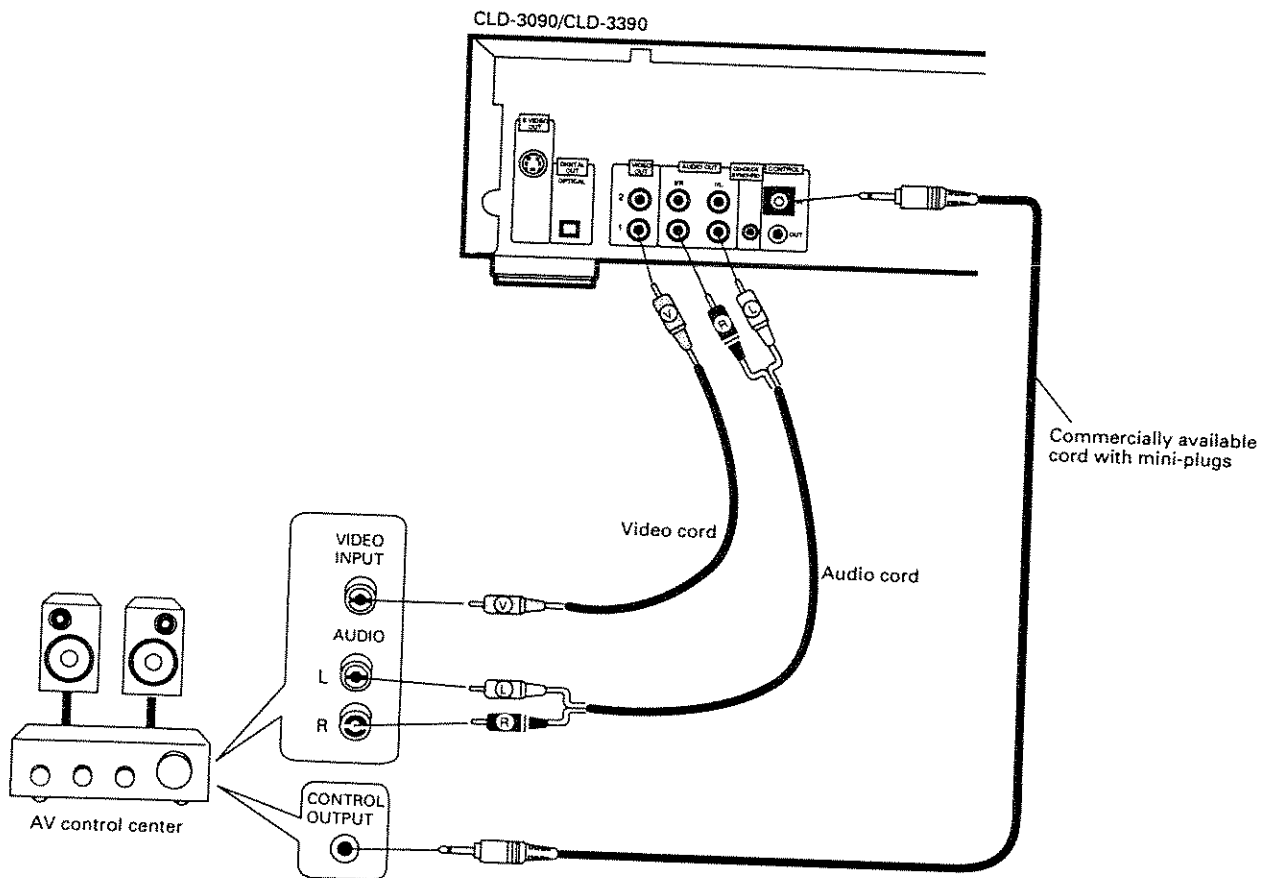

NAMES AND FUNCTIONS OF REMOTE CONTROL UNIT COMPONENTS

A detailed description is provided on the indicated page(s).

Remote control buttons with the same names or marks as buttons on the front panel of the player control the same operations as the corresponding front panel buttons.

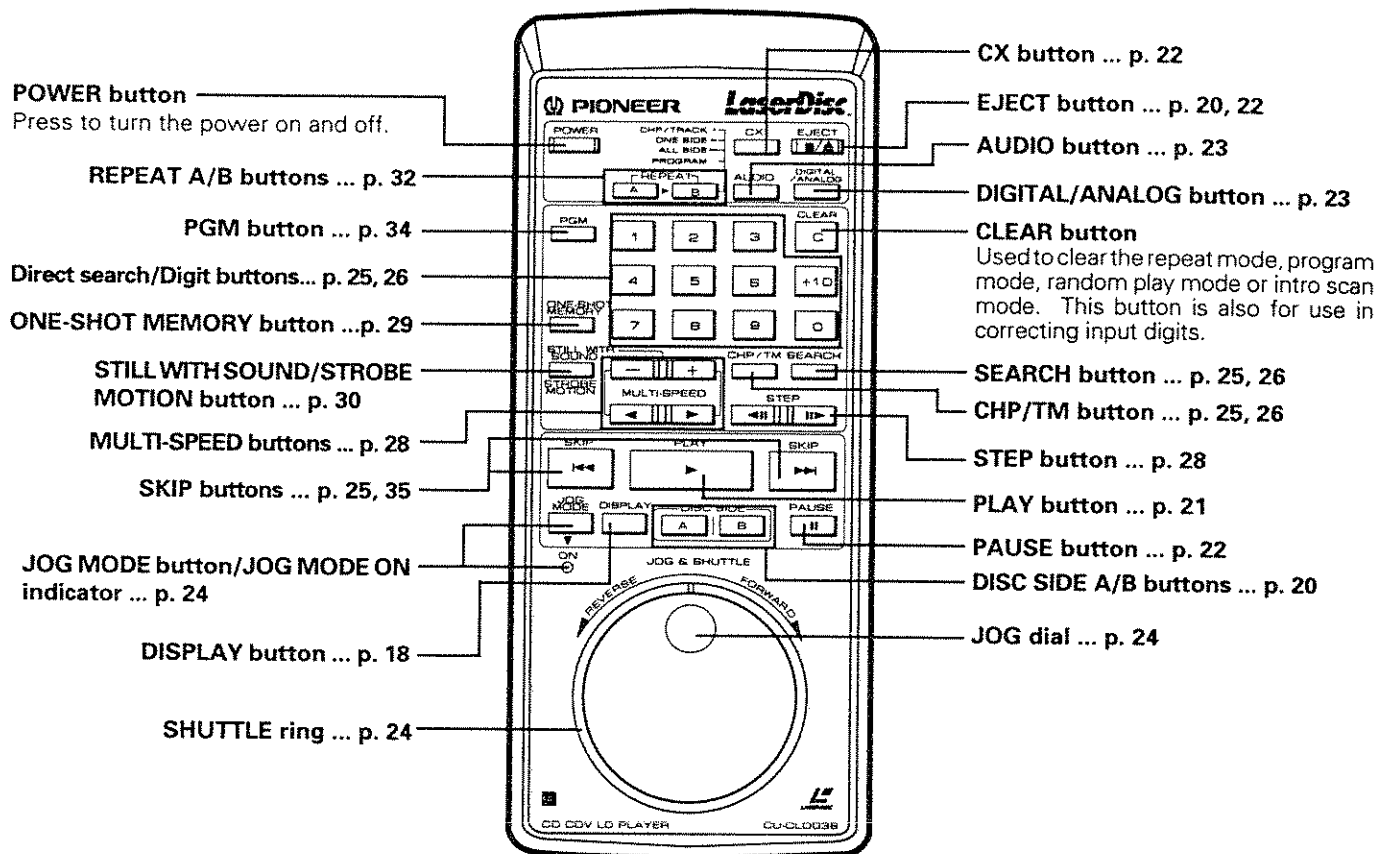

When operating the remote control unit, point the unit's infrared signal transmitter at the remote control receiver (REMOTE SENSOR) on the front panel of the player. The remote control unit can be used within a range of about 5 meters (16 feet) from the remote sensor, and within angles of up to about 30 degrees.

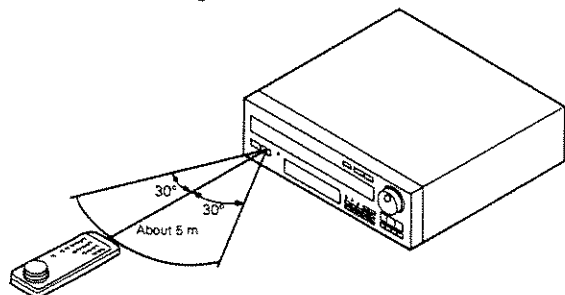

NOTE FOR USING THE REMOTE CONTROL UNIT

- If a plug is connected to the CONTROL IN terminal at the rear of the player, remote control operations cannot be done with the remote control unit aimed at the player's remote control sensor. Aim the remote control unit at the AV control center or the component display's sensor instead.

- If there is any obstacle between the remote control unit and the player, or if the unit is held at too large an angle relative to the front panel of the player, the signal from the remote control unit will fail to reach the remote sensor.
- If the player is operating in the vicinity of other appliances generating infrared rays, or if other remote control devices using infrared rays are used near the player, the player may operate improperly. Conversely, if the player's remote control unit is operated in the vicinity of other appliances which use an infrared remote control device, the other appliance may operate improperly. If this should happen, change the place of installation so that improper operation does not occur.
- If the range of operation of the remote control unit becomes too short, replace the batteries.
- When the unit is not to be used for a long period of time (more than one month), remove the batteries to prevent them from leaking inside the compartment. If leakage occurs, wipe up the liquid inside the compartment and replace the batteries with new ones.
- Do not place books or other objects on the remote control unit, since they might depress the buttons and run down the batteries.
- If the remote control sensor window is in a position where it receives strong light such as sunlight or fluorescent light, control may not be possible.

NAMES AND FUNCTIONS OF FRONT PANEL COMPONENTS

A detailed description is provided on the indicated page(s).

SOFT PICTURE button/indicator

Press to turn the soft picture function on and off. When the soft picture function is ON, SOFT PICTURE indicator lights and picture will be softened.

REMOTE SENSOR ... p. 15

POWER STANDBY/ON switch

Press to turn the power on and off.

PHONES jack ... p. 21

PHONES LEVEL control

Turn this control in the "MAX" direction to increase the output level from the PHONES jack. Turn this control in the "MIN" direction to decrease the output level from the PHONES jack.

Display window

TRACK/CHAP. indicator

Indicates the TRACK number or CHAP. (chapter) number.

REP indicator

Lights during repeat play.

⏸ PAUSE indicator

Lights when the player is in pause mode.

PGM indicator

Lights during program play.

▶ PLAY indicator

Lights during play. Blinks during search.

SIDE A indicator

Lights during play, only the programmed chapter/track numbers light. When a disc without a TOC section is played, only the selection number being played lights.

ONE-SHOT MEMORY indicator

Blinks when ONE-SHOT MEMORY is pressed.

LD side A/CDV visual calendar

When a disc is loaded, all of the chapter/track numbers recorded on the disc light up on the display. If the disc contains more than 19 chapters/tracks, the → indicator lights. During program play, only the programmed chapter/track numbers light. When a disc without a TOC section is played, only the selection number being played lights. When a CDV disc is loaded, the track numbers of the video part light followed by the track numbers of the audio part. After a chapter/track is finished playing, the corresponding number goes out.

LD/CDV/CDV indicator

Indicates the type of disc loaded in the player.

EDIT indicator

Lights when editing is performed.

PEAK indicator

Lights while searching for the peak level.

REMAIN/TOTAL indicator

Indicates the REMAIN TIME (remaining play time) or TOTAL TIME (total play time).

Door/Disc table ... p. 21

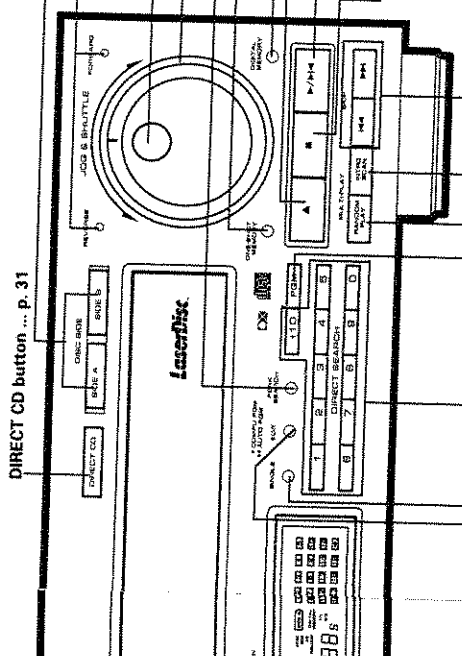

FL DISPLAY switch ... p. 21

SINGLE indicator

Lights during Single play.

RANDOM indicator

Lights during random play.

FRAME/TIME indicator

Indicates the FRAME number or TIME.

DIGITAL SOUND indicator

Lights when the disc being played has a digital sound signal. With LD discs, this indicator lights when the digital sound signal is selected.

INTRO indicator

Lights during Intro Scan mode.

SIDE B indicator

Lights during Intro Scan mode.

LD side B visual calendar

A visual calendar for the B side of two-sided LDs. Numbers light in the same way as on the side A visual calendar.

1/L, 2/R indicator

Indicates the audio output channel.

DIGITAL MEMORY indicator

Lights when digital memory is ON.

DIGITAL MEMORY button:

When playing a CAV or CLV disc, turning the digital memory function ON allows you to enjoy special playback functions such as still frame and multi-speed playback with no screen disturbance. If the digital memory function is OFF, it will automatically turn ON when you fast-forward, fast-reverse or activate a special playback function (except with CAV discs). When digital memory is OFF, screen disturbance may occur momentarily when an operation such as fast-forward is carried out. However, horizontal resolution is better than when digital memory is ON.

Notes:

- When using a special function obtained by connecting commercially available adaptor (such as a caption adaptor), be sure to turn the digital memory function OFF. Adaptor will not function properly if digital memory is ON.
- Screen disturbance may occur momentarily when operation such as fast-forward, fast-reverse or a special playback function is carried out when digital memory is OFF. This is not a malfunction or disc defect.
- This player memorizes the ON/OFF condition of the digital memory function even if the power is turned off. Turn digital memory function ON or OFF as required the time you play a disc. The "DIGITAL MEMORY" indicator lights in the display window when digital memory is ON.

DISPLAY SWITCHING

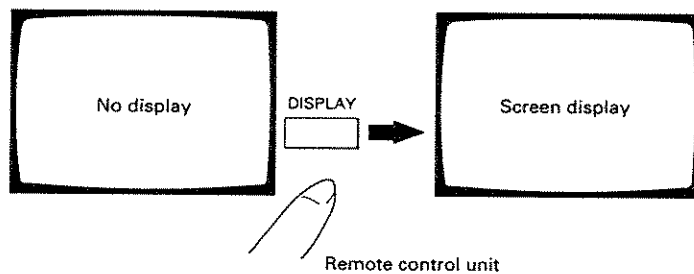

Information regarding the operations being carried out can be displayed on the screen of the monitor TV. When DISPLAY on the remote control unit is pressed the first time, the screen is displayed.

With LD discs containing a TOC ...

Each time DISPLAY is pressed, the display changes in the following order: time/frame number (elapsed play time/frame from the beginning of the disc) → Remain Time ALL (remaining play time of the disc) → Total Time (total play time of the disc) → display off.

- With CAV discs, the Disc time ABS (elapsed play time from the beginning of the disc) is displayed after the frame number.

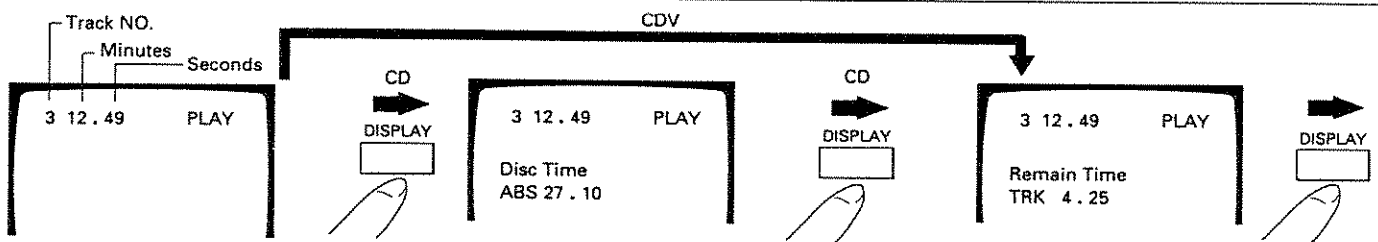
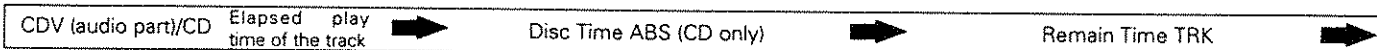
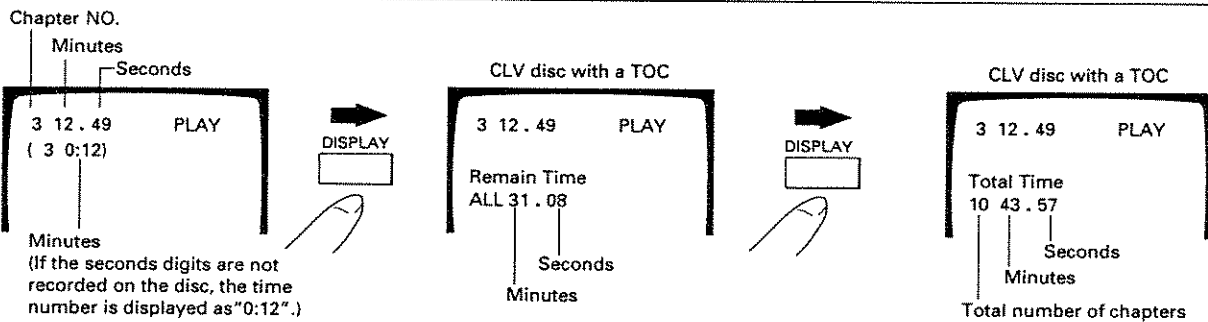

Other displays

Lights - Flashes	Function	Lights - Flashes	Function
OPEN	Opening of the table	Program	Program mode
CLOSE	Closing of the table	Step-	Chapter/Track program step
STOP	Stop mode	One-shot	One-shot memory
PLAY	Play mode	Random	Random play
PAUSE	Pause mode	Pgm. Rnd	Program random play
STILL	Frozen picture	Editing	Edit mode
1/2, 1/4...	Slow-speed play	Normal	Auto program edit
x2, x3	High-speed play	Compute	Compu program edit
CLV	CLV play	Intro	Intro scan mode
Video	Video part search	Digital	Digital signal setting
Audio	Audio part search	Analog	Analog signal setting
A	Side A play	Stereo	Stereo
B	Side B play	1/Lch	Main audio/Left channel
Repeat Memory	Memory repeat	2/Rch	Sub audio/Right channel
Repeat A-B	A-B repeat	CX ON	CX noise reduction system ON
Repeat Side -A (B)	One side repeat	CX OFF	CX noise reduction system OFF
Repeat All	Two-side repeat	Last Memory	Last memory
Repeat Chapter (Track)	Chapter/track repeat	Peak	Peak search
Repeat Random	Random repeat play	Single	Single play
Repeat Program	Program repeat	Soft ON	Soft picture ON
		Soft OFF	Soft picture OFF

With LD discs having no TOC...

Each time DISPLAY is pressed, the display changes in the following order: time/frame number → display off.

With CDV discs...

Each time DISPLAY is pressed, the display changes in the following order: elapsed play time of the track being played → Remain Time TRK (remaining play time of the track being played) → Remain Time ALL (remaining play time of the video or audio part being played) → Total Time (total play time from the beginning of the video or audio part being played) → display off.

With CD discs ...

Each time DISPLAY is pressed, the display changes in the following order: elapsed play time of the track being played → Disc Time ABS (elapsed play time from the beginning of the disc) → Remain Time TRK (remaining play time of the track being played) → Remain Time ALL (remaining play time of the disc) → Total Time (total play time from the beginning of the disc) → display off.

- These data are also displayed on the display window of the front panel.

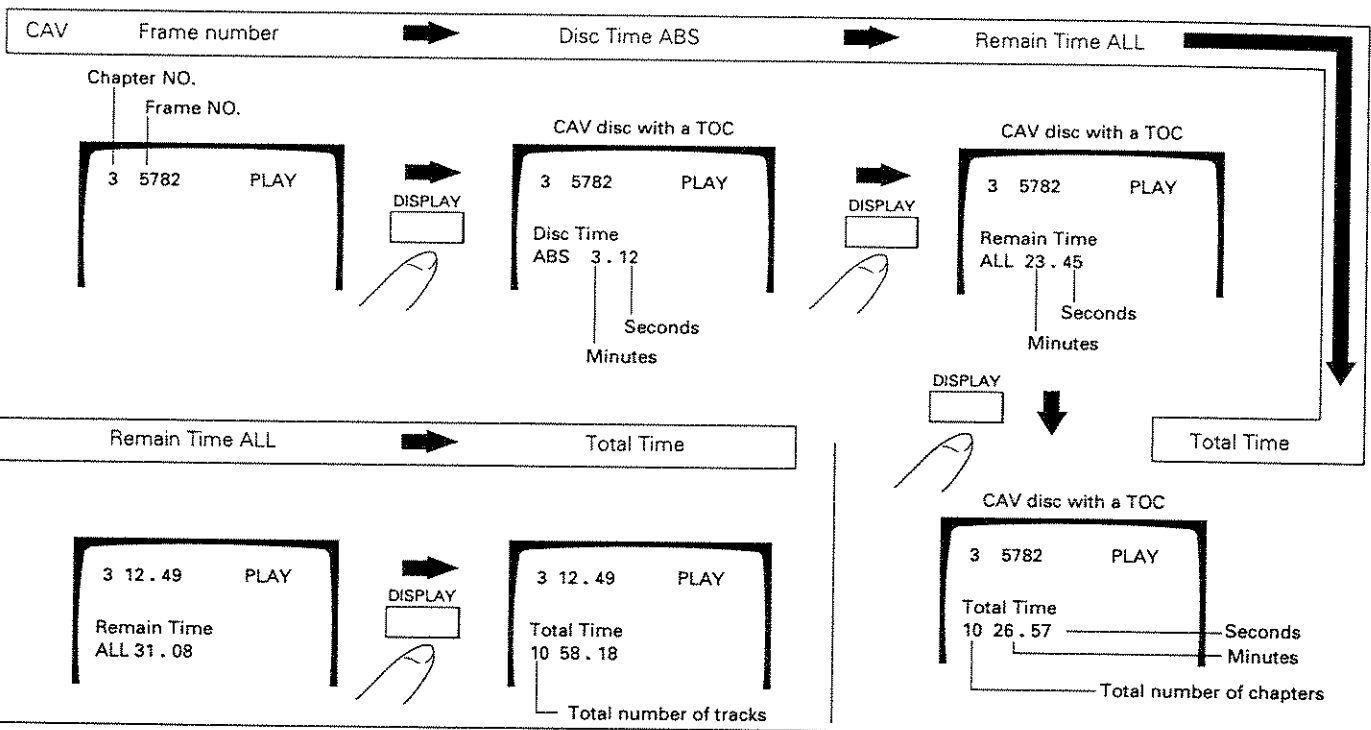

Audio output level meter display:

During elapsed play time of the track mode of CD playback or CDV (audio part) playback, the audio output level meter will be displayed on the monitor screen.

NOTE:

In some cases, the displayed output level may differ from the actual output level, but this is not a malfunction.

NOTE:

When the Direct CD function (→ p. 31) is activated, the player does not display information on the monitor screen.

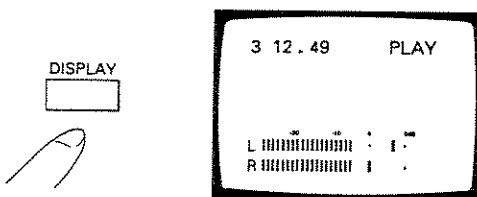

TO PLAY AN LD, CDV OR CD

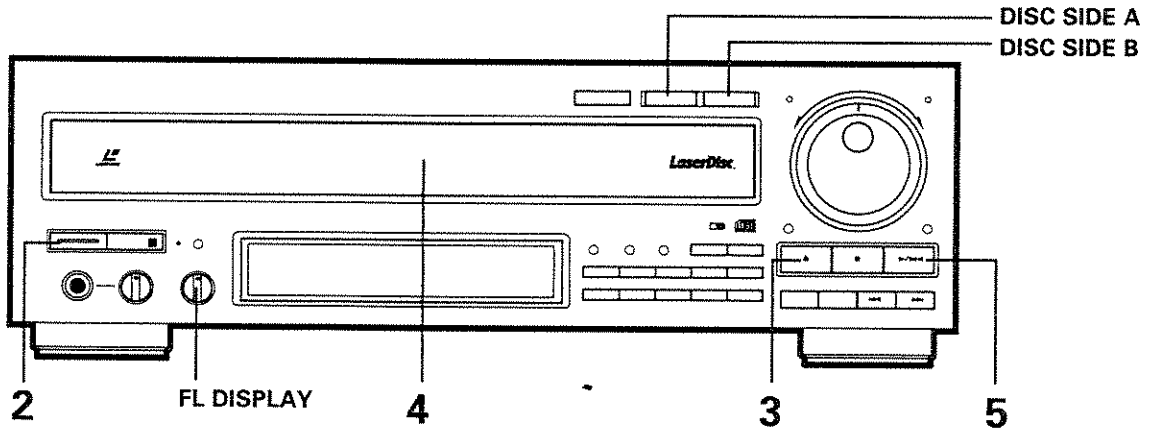

1

Turn on the power to the monitor TV and/or audio system.

When a stereo system is used for audio listening:

Turn on the power of the amplifier, and set its input selector to the proper position for listening to the player, such as "LD".

2

Turn on the power to this unit.

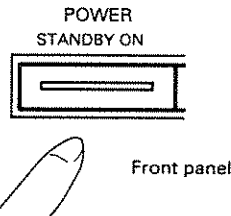

or

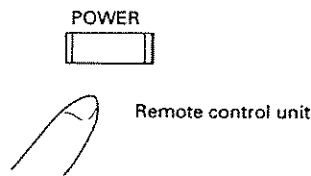

3

Open the disc table.

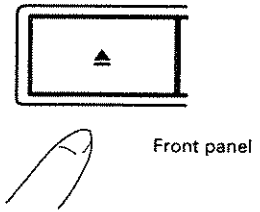

or

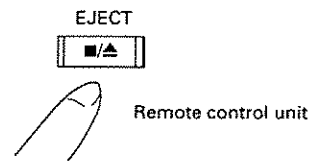

State of the display window during playback:

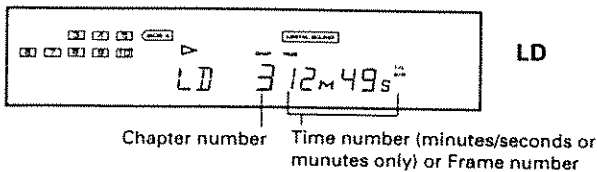

LD

To specify and play a single side (side A or side B)

To play side A only, press DISC SIDE A instead of PLAY. Side A will be played and then playback will stop.

To play side B only, press DISC SIDE B instead of PLAY. Side B will be played and then playback will stop.

State of the display window during Alpha-turn:

- During switching from side A to side B

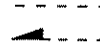

- During switching from side B to side A

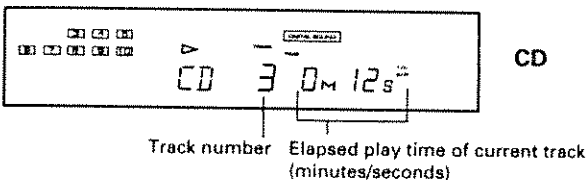
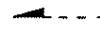

CD

Front panel buttons and remote control unit buttons with the same name or mark have the same function.

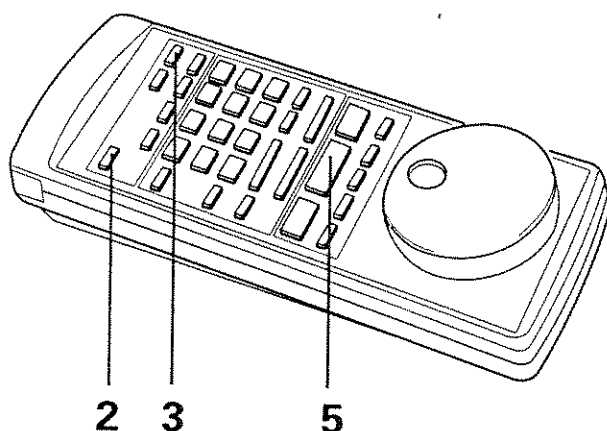

4

Load a disc

As shown in the following diagram, place the disc on the disc table in the groove corresponding to the size of the disc.

If the disc is not centered correctly on the disc table, the disc will not be played or the disc or the player may be damaged.

Always place the disc correctly according to the required disc size on the disc table.

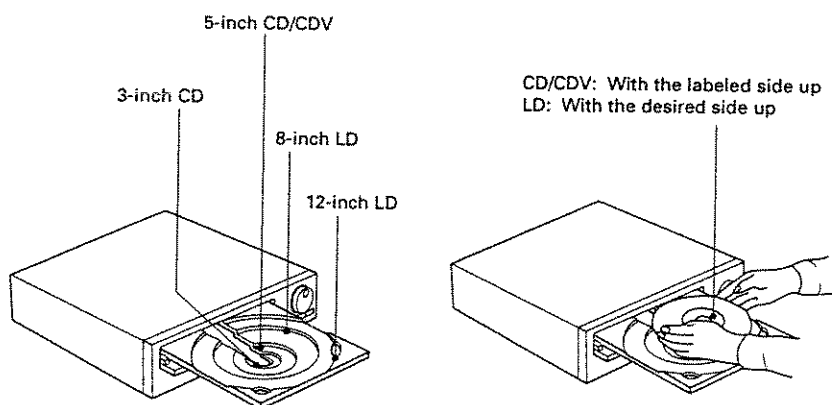

5

Start playback.



PLAY

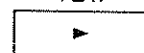

- With CDV discs, the video part is played first.
- With two-sided LDs, after the A side of the disc (the side facing upward) is played, a still frame is displayed and then the unit automatically begins playing the B side.

To avoid malfunctions, be especially careful about the following points.

- Do not place any object other than a disc on the disc table.
- Do not move the player while a disc is playing. This will cause the disc to be scratched.
- Be careful not to catch your finger in the disc table section while the disc table is being retracted into the unit. Also, be careful that children do not put their hands into the inside of the unit while the disc table is open. This may cause injury.

Precautions concerning disc loading

- Do not place more than one disc on the disc table. If two discs are placed one on top of the other on the disc table, discs may be scratched and/or malfunction may occur.
- With this unit, playback of all types of discs is carried out without the use of adapters. Therefore, do not use any type of adapter with this unit.

- With CDs, CDV discs, and single-sided LDs, always be sure to load discs with the label side facing upward.

Last Memory function:

If the power is turned off during LD playback, a playback position slightly ahead of the current frame is stored in the unit's memory (Last Memory). When the power is turned back on and playback begins from the memorized position by pressing ►/►◄.

To play and listen to a disc without connecting this unit to an audio system:

Plug headphones into the PHONES jack on the front panel of this unit and adjust the volume with LEVEL control.

To turn off the display in the front panel display window:

Set FL DISPLAY switch to OFF.

To turn on the display, set FL DISPLAY switch to ON.

TO PLAY AN LD, CDV OR CD (Continue)

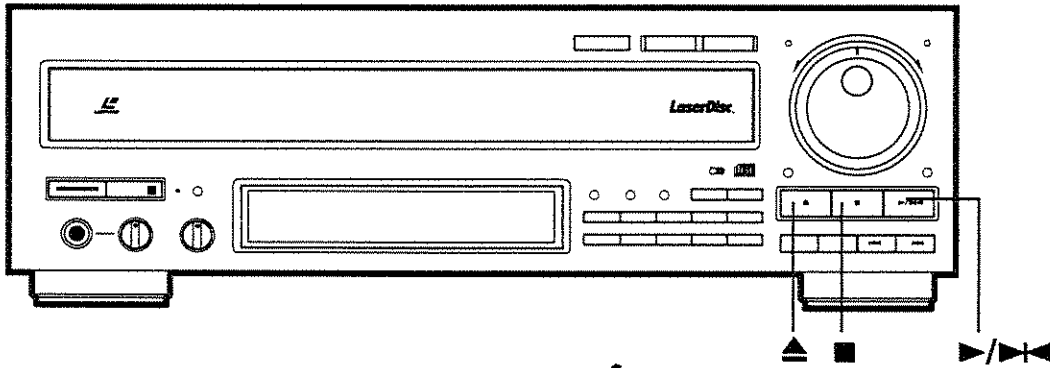

To pause playback temporarily

PAUSE



Remote control unit

The sound and/or video image disappears and the **||** indicator lights on the display window. Press PAUSE **||** again to resume playback from the position where pause mode was entered.

- During playback of CD or CDV audio part, front panel **▶/▶|◀** is also used to pause playback temporarily.



To stop playback



Front panel

or

EJECT



Once

Remote control unit

When PLAY **▶** is next pressed, disc playback starts again from the beginning.



To stop playback and take out the disc



Front panel

or

EJECT



Twice

Remote control unit

After removing the disc from the disc table, press **▲** or PLAY **▶** to close the table.

Discs marked with the **OX** mark

Discs marked **OX** are recorded with the CX noise reduction system for powerful audio reproduction with little noise. (Analog audio only) However, some discs marked are not encoded with the signals necessary to instruct the unit to automatically switch on the CX system. If sound is noisy or undulate when a disc with a **OX** mark is played, press CX on the remote control unit.

- **OX** is a trademark of CBS inc. This player meets the CX EXPANDING SPECIFICATION.

To watch a TV broadcast:

Switch to the broadcast using the controls of your TV.

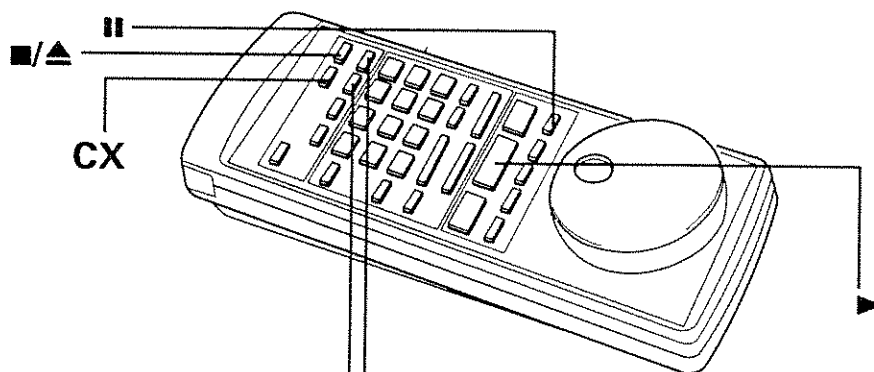

To listen to only one channel of a stereo disc, or to select the audio on a sound multiplex disc

During playback

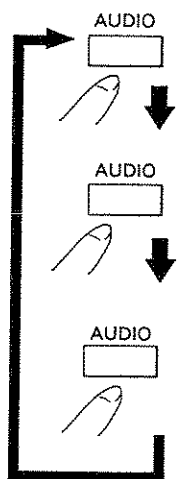

Played audio		Display on display window
Stereo disc	Sound multiplex disc	
Stereo	Audio 1/L (Left) Audio 2/R (Right)	1/L 2/R
Left	Audio 1/L (Left)	1/L
Right	Audio 2/R (Right)	2/R
Return to start		

To listen to the analog audio of an LD digital audio disc:

During playback

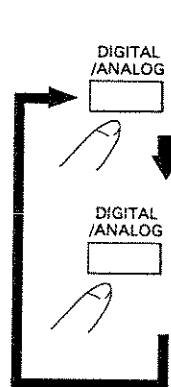

Played audio	DIGITAL SOUND indicator
Digital	Lights
Analog	Goes off
Return to start	

With a Multi Audio disc (an LD bearing the **MULTIAUDIO** mark), you can listen to the various audio tracks recorded on the disc by using DIGITAL/ANALOG to select between the analog and digital audio tracks, and by using AUDIO to select between the left (1/L) and right (2/R) channels.

Examples of the various types of audio recorded on Multi Audio discs

Disc	Audio	Analog audio	Digital audio
Movies, animations, etc.		Audio of the main program	Soundtrack
Dual music		Music 1	Music 2
Various types of digital audio karaoke		1/L Karaoke (monaural) 2/R Assisting vocals	Stereo karaoke
Stereo bilingual		Native language	Foreign language 1

Disc	Audio	Analog audio	Digital audio
Trilingual		Native language	1/L Foreign language 1 2/R Foreign language 2
Quadlingual		1/L Native language 2/R Foreign language 1	1/L Foreign language 2 2/R Foreign language 3

TO SEARCH FOR A PARTICULAR PASSAGE

Search using the Shuttle Ring and Jog Dial

Using the Shuttle Ring and Jog Dial changes playback speed and direction. This function is useful to search for a desired passage.

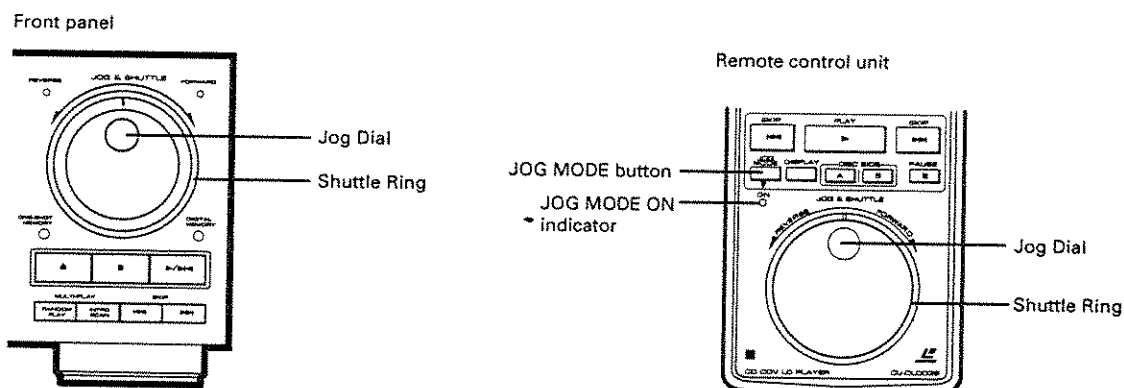

Jog dial (LD/video part of CDV)

Playback is advanced according to the speed and direction of rotation of the jog dial. Both forward and reverse playback is possible, and frames can be advanced at speeds of 1/2 speed, normal speed, and double speed. Rotating the jog dial clockwise forwards playback. Conversely, rotating it counterclockwise left reverses playback. To use the jog dial on the remote control unit, first press JOG MODE so that JOG MODE ON indicator lights. During playback of an LD or CDV video part, when the jog dial stops rotating, the frame is displayed.

Shuttle ring

While rotating the Shuttle ring, playback advances or reverses at high speed. There are three scan modes which can be selected with rotational angles of the Shuttle ring.

Clear Scan mode: Slightly rotate the Shuttle ring. The image may not be fluctuated in this mode.

Low Scan mode: Further rotate the Shuttle ring. Scan speed becomes about x10 the normal playback speed.

High Scan mode: Fully rotate the Shuttle ring at greater angle. Scan speed becomes about x30 the normal playback speed.

- With CDs or audio part of CDVs, Clear Scan mode cannot be carried out.
 - With video part of CDV, High Scan mode cannot be carried out.
-
- In Clear Scan mode, when digital sound is selected with digital audio discs, sound is heard at low volume level.
 - With CDs or audio part of CDVs, sound is heard at low volume level while scanning
 - Others: Sound is muted.

To resume normal playback after using the jog dial:
Press PLAY ►.

When not using the jog dial on the remote control unit, set JOG MODE to OFF.

Although JOG MODE will automatically switch OFF (JOG MODE ON indicator goes out) approximately 5 minutes after you stop operating the jog dial, it is recommended that you set JOG MODE to OFF as soon as you finish using the jog dial in order to prevent unnecessary battery consumption.

Notes on CAV:

While scanning, noise may occur on the screen. This is not a malfunction.

Notes on CLV:

- While scanning, the color of the image may fade out or the image sometimes fluctuates.
- The scan speed is different between inner tracks and outer tracks.

TO SEARCH FOR A PARTICULAR CHAPTER/TRACK

Chapter (Track) Search/Chapter (Track) Skip/Intro Scan

The term "chapter" refers to each section on an LD, and the term "track" refers to each section on a CD or CDV disc.

If chapter or track numbers are encoded on a disc, it is so indicated on the disc jacket.

- Chapter Search is not possible with discs which are not divided into chapters.

Chapter (Track) Search – To search by designating the chapter/track number

Example:

To play from the beginning of Chapter/Track 3:

<Direct Search>

3

Enter 3 with the digit button.



<Normal Search>

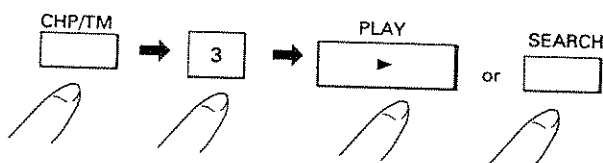

When the display shows Frame No. or Time No. press this button again. Enter 3 with the digit button.

To search for chapter or track number 10 or above:

Use **[+10]** button.

(Example) To enter 17: **[+10]**, **[7]**

To enter 30: **[+10]**, **[+10]**, **[+10]**, **[0]**

If you make a mistake in pressing the digit buttons:
Press CLEAR, and then press the correct button.

To identify the present chapter number and frame (or time) number:

The numbers are displayed in the front panel display window. The information can also be displayed on the monitor TV screen by pressing DISPLAY on the remote control unit.

Notes on LDs

If **PLAY** or **SEARCH** on the remote control unit is pressed, the beginning of the designated chapter is played with still frame.

If **▶/▶◀** on the front panel is pressed, Normal playback starts from the beginning of the designated chapter.

Chapter (Track) Skip – To search for the beginning of a chapter/track

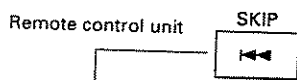

Press once to return the playback position to the beginning of the chapter/track being played. If the key is pressed more than once before the picture reappears, the beginning of a chapter/track located before the chapter/track being played is searched for and played. The position of the located track corresponds to the number of times the button is pressed.

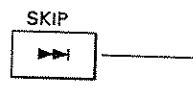

If this button is pressed once or a number of times, playback is advanced to the beginning of a chapter/track located after the chapter/track being played. The position of the located track corresponds to the number of times the button is pressed.

Intro Scan – To search by playing each beginning of all chapters/tracks

INTRO
SCAN



When INTRO SCAN on the front panel is pressed, the beginning of each chapter/track is played for about 8 seconds. During the desired chapter or track is played, press **▶/▶◀** on the front panel or **PLAY** on the remote control unit. The unit enters play mode. If **PAUSE** on the remote control unit is pressed, the unit enters pause mode.

To cancel the search operation

Press CLEAR while the player is searching for the chapter or track.

TO SEARCH FOR A PARTICULAR TIME/FRAME

Time Number Search/Track time Search/ABS Time Search/Frame Number Search

Time Number Search – Example: To search for the scene located at time number 12 min. 34 sec (CLV)

1. **Press CHP/TM.**
When the display shows chapter No., press this button again.
2. **Enter 1, 2, 3 and 4 with the digit buttons.**
If you make a mistake during entry:
Press CLEAR to reset the time number to "0.00", and press the correct digit buttons again.
3. **Press SEARCH or PLAY ►.**

CAUTION

- If a disc does not contain information on the digits of seconds, specify the time number only as far as the minute digits.

Track Time Search – To search for a time on a specified track (CD/CDV)

1. **Press CHP/TM.**
2. **Press SKIP ◀◀ or ▶▶** so that the desired track number appears in the front panel display window.
3. **Enter the track time (elapsed time from the beginning of the specified track) with the digit buttons (0 - 9).**
4. **Press SEARCH or PLAY ►.**

ABS Time Search (CD only) – To search for a point by designating the elapsed time from the beginning of the disc

- 1 **Press CHP/TM so that "Ab" appears in the front panel display window. (On the monitor screen, "ABS" appears.)**
- 2 **Enter the elapsed time from the beginning of the disc with the digit buttons (0-9).**
- 3 **Press SEARCH or PLAY ►.**
Playback starts from the specified elapsed time.

Frame Number Search (CAV discs only) – To search by designating the frame number

Any desired frame can be searched for by specifying its frame number.

1. **Press CHP/TM. When the display shows chapter NO., press this button again. "Frame 0" is displayed.**
2. **Enter the required frame number with the digit buttons (0 - 9).**
3. **Press SEARCH or PLAY ►.**

To exit search mode:
Press CLEAR.

NOTES:

- The +10 button does not function.
- If you make a mistake during entry, press CLEAR and press the correct digit buttons.

When SEARCH or PLAY ► on the remote control unit is pressed:
A still frame is displayed (LD or video part of CDV). To start normal playback, press PLAY ►.

CONVENIENT FUNCTION FOR KARAOKE PLAY – Single Play

With this function, playback pauses after the specified track is played (One-Song Pause function).

1. Press SINGLE on the front panel.

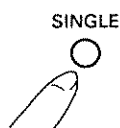

2. Select a track with DIRECT SEARCH on the front panel or the digit buttons on the remote control unit.

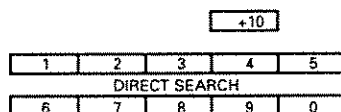

- After one track is played, you can play another track by specifying the track number with DIRECT SEARCH or the digit buttons.
- With multi audio discs, the original vocals or musical accompaniment can be selected for karaoke play by using AUDIO or DIGITAL/ANALOG on the remote control unit. See page 23.

NOTES

- When $\blacktriangleright/\blacktriangleleft$ is used to start play, One-Song Pause function cannot be carried out. Be sure to use DIRECT SEARCH or the digit buttons when specifying the track number.

LD with TOC/CD/CDV

TO PLAY ALL CHAPTERS/TRACKS IN A RANDOM ORDER – Random Playback

Random Playback allows all chapters/tracks of one side of a disc in random order.
Press RANDOM PLAY on the front panel.



Display during Random Play (CD)
To display the music calendar, press DISPLAY so that the display shows time display.

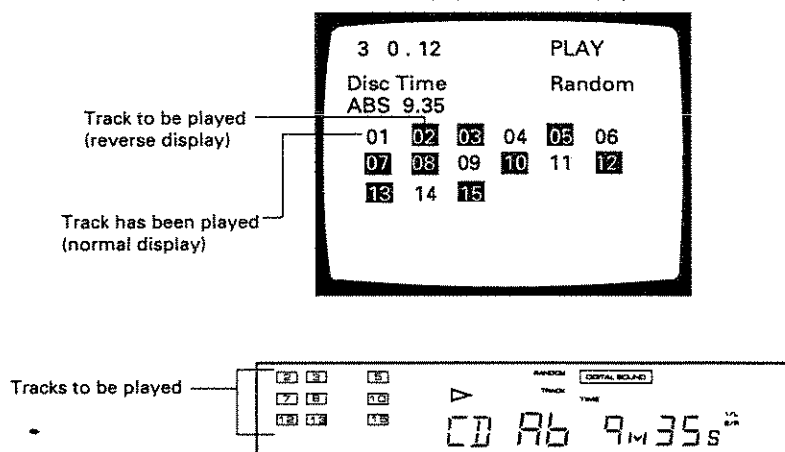

NOTE:

With Random Playback, chapter No. 0 will not be played.

To go to the next chapter/track during Random Playback:

Press \blacktriangleright .

(The previous chapter/track cannot be played by pressing \blacktriangleleft .)

To stop Random Playback:

Press CLEAR on the remote control unit.

After CLEAR is pressed, playback will continue in the order in which the chapters/tracks are recorded on the disc.

To enter stop mode:

Press \blacksquare or $\blacktriangle/\blacktriangleleft$.

Random Playback with CDV discs:

Tracks in the video and audio part are played in a random order.

Program Random Playback:

To play the programmed chapters/tracks in random order, press RANDOM PLAY during programming or program playback.

EXTRA PLAYBACK

Still frame and Frame-by-Frame advance function

Remote control unit



Press either of these buttons.

During playback if STEP on the remote control unit is pressed, the picture will be frozen. At this point, the disc can be played one frame at a time in either the forward or reverse direction by pressing one of these buttons. The sound is muted during still frame or frame advance operation. To return to normal operation, press PLAY ►.

- Front panel ►/◄ is also used to display the still frame.

To vary the playback direction or speed

Remote control unit



Remote control unit



During playback, the playback direction can be changed with MULTI-SPEED. 1/4 the normal playback speed is set automatically.

With + and - buttons, the playback speed can be changed from x 3 to 1/90 the normal playback speed.

Sound is muted during Multi-speed playback operation. To return to normal playback operation, press PLAY ►.

- The selected speed is displayed by pressing DISPLAY on the remote control unit.

Speed display	Speed
x3	3 times the normal playback speed.
x2	Twice the normal playback speed.
x1	Normal playback speed.
1/2	1/2 the normal playback speed.
1/4	1/4 the normal playback speed.
1/8	1/8 the normal playback speed.
1/16	1/16 the normal playback speed.
1/30	1/30 the normal playback speed.
1/90	1/90 the normal playback speed.

Faster
↑
↓
Slower

No sound?

During Multi-speed playback, sound is not heard.

If playback automatically switches to still frame display mode.

If a disc containing special signals called "picture stop codes" is played at x1, 1/2, 1/4, 1/8, 1/16, 1/30, or 1/90 speed, playback pauses automatically whenever the unit encounters a frame where a picture stop code is encoded, and the still picture of that frame is displayed on the monitor screen. To move from that position, press PLAY ► or MULTI-SPEED ◄/►.

One-Shot Memory

The One-Shot Memory function stores the image of a single frame in the player's memory. When the One-Shot Memory function is activated and playback of the current disc is completed, the stored image is recalled and displayed on the screen. Since the image is displayed even after playback is completed, this function is convenient for displaying an image on the screen while changing discs. This function also allows you to change discs and listen to the audio of a CD or CDV disc while the image remains on the screen as a background video image.

Remote control unit

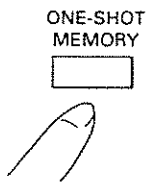

During normal playback, press ONE-SHOT MEMORY when the desired scene appears on the screen.

After playback is finished, the memorized frame appears on the screen and ONE-SHOT MEMORY indicator lights. In this state, even if you change discs the scene displayed on the TV screen does not change. To cancel the One-Shot Memory function in order to play the video from another disc, press ONE-SHOT MEMORY again.

The frame displayed when the button was pressed is stored in memory. ONE-SHOT MEMORY indicator blinks and "One-shot" is displayed on the TV screen for a few seconds.

With CDV discs, the following operation can also be performed:

1. Press ONE-SHOT MEMORY during playback of the video part.
 2. Perform a direct search to the audio part.
- The memorized image of the video part is displayed on the screen while the audio part is played back.

NOTES:

- With the One-Shot Memory function, since the player memorizes the selected frame by recording its address, a frame which is slightly different than the one you thought you selected may be displayed. Also, if seconds are not recorded on the disc, a completely different frame may be displayed.
- While the memorized image is displayed on the TV screen, the character display will not appear on the screen. The display may be switched by using DISPLAY on the remote control unit.
- With two-sided LDs, if disc side is switched after ONE-SHOT MEMORY is pressed during playback, the One-Shot Memory function will be canceled.

EXTRA PLAYBACK

Still with Sound Playback

With the Still with Sound Playback function, you can stop the video image and display a still frame while continuing to listen to normal playback of the audio part.

Remote control unit

STILL WITH
SOUND



STROBE
MOTION



During normal playback, press STILL WITH SOUND/STROBE MOTION when the desired scene appears on the screen.

The screen is frozen at the current frame and the audio continues playing.

To resume normal playback:

Press PLAY ►.

Strobe Motion Playback

With the Strobe Motion Playback function, the still frame displayed using the Still with Sound Playback function is replaced with successive still frames at regular intervals (variable), resulting in a strobe motion effect.

Remote control unit



After pressing STILL WITH SOUND/STROBE MOTION, press + or - button.

- : Increases the frame replacement interval.
- + : Decreases the frame replacement interval.

The still frames shown on the screen are replaced in sequence according to the selected replacement interval, while the audio continues as normal.

By repeated pressing of **+** and **-** buttons, one of seven different replacement intervals can be selected.

"-" button	Screen display	Replacement interval	"+" button
↓	x1	Every frame	↑
	1/2	Every 2 frame	
	1/4	Every 4 frame	
	1/8	Every 8 frame	
	1/16	Every 16 frame	
	1/30	Every second	
	1/90	Every 3 seconds	

Normal playback is carried out at 30 frames/second. When the power is turned on, the replacement interval is initialized at "Every 4 frames".

In order to maintain normal audio playback, faster than normal playback modes such as x2 and x3 are not provided.

To resume normal playback:

Press PLAY ►.

PARTICULAR FUNCTIONS FOR CD – Direct CD/Peak Level Search

Direct CD

Since the picture circuit is deactivated and the interference between signals is eliminated with the Direct CD function, more pure sound can be reproduced.

- When the Direct CD function is activated, the player does not display information on the monitor screen.
- In Direct CD mode, time for starting play becomes short compared with that of normal play operation.

1 Press DIRECT CD on the front panel.

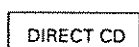

2 Open the disc table.



or

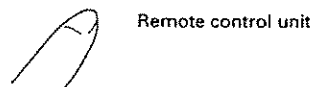

- The disc table comes out according to the CD size.

3 Start play.



or



To exit Direct CD mode:

Press DIRECT CD again. Also, when the video part of CDV is played, Direct CD mode is canceled automatically.

To play an LD:

Cancel the Direct CD mode. Otherwise, the LD cannot be set on the disc table.

NOTE:

During LD or CDV (video part) play, the player does not enter Direct CD mode even if DIRECT CD is pressed. When playing the audio part of CDV, you can press DIRECT CD.

Peak Level Search

With this function, the peak level of CD or CDV (audio part) can easily be searched for. This is convenient for adjusting the proper recording level.

To search for the peak level of the entire disc:

1 Press PEAK SEARCH on the front panel.

PEAK SEARCH



The player scans the entire disc and searches for the peak level. It takes for about 1 minute and 20 seconds with 60-minute disc. While searching, the PEAK indicator is lit on the display.

To search for the peak level of the programmed tracks:

Program the desired tracks beforehand (page 34) and press PEAK SEARCH. The player scans all of the programmed tracks and searches for the peak level between them.

To adjust the recording level

1. When the player detects the peak level, the section which contains the peak level is played repeatedly for about 8 seconds.
2. Adjust the recording level on the tape deck.
3. Set the tape deck to recording mode and start CD play by pressing ►/►◀.

NOTES:

- The player sometimes detects the different peak level even when the peak search function is carried out on one disc.
- With some discs, the player cannot detect the proper peak level. This is not a malfunction.

TO REPEATEDLY PLAY A DESIRED PASSAGE – Repeat Playback

Memory Repeat – To specify a point to return to later

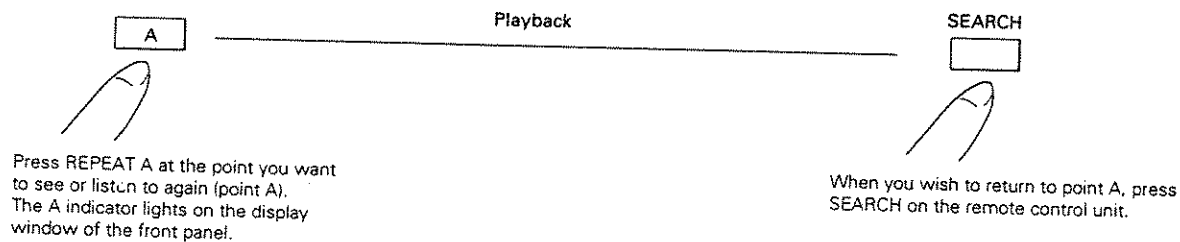

A-B Repeat – To repeat a specified section

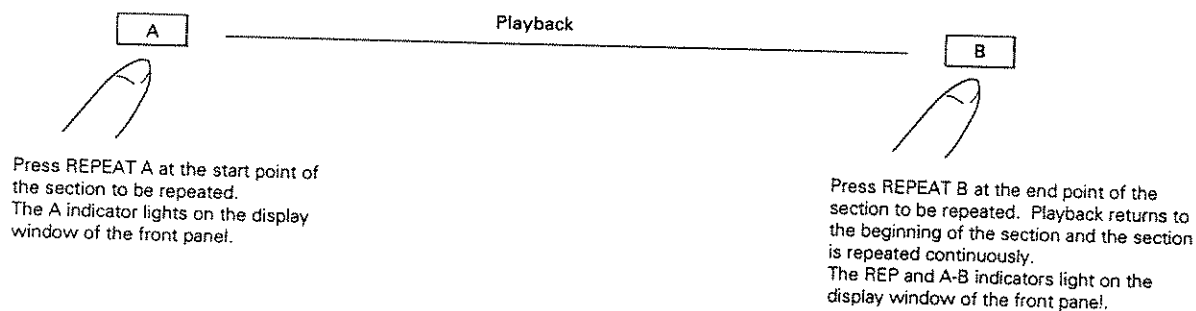

Chapter/Track Repeat – To repeat the current chapter or track

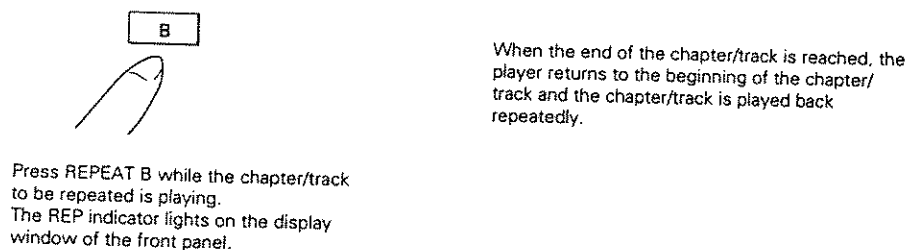

To exit repeat mode:

Press CLEAR on the remote control unit. Repeat mode is canceled and normal playback continues from the current point.

To specify a different point in Memory Repeat mode:

Press REPEAT A at the new point. The previously memorized point is erased and replaced with the new point.

Memory Repeat and A-B Repeat with CDV discs:

These repeat functions can only be carried out within the video part or within the audio part, and cannot be carried out between the two parts.

With LDs which have no chapter numbers:

Chapter repeat cannot be carried out.

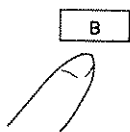
One Side Repeat – To repeat an entire side of a disc

Press REPEAT B twice.
The REP SIDE A or B indicator lights on the display window of the front panel.

When playback reaches the end of the playback side, the player returns to the beginning of the disc and the same side is played back repeatedly.

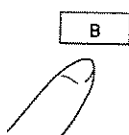
Two-Side Repeat – To repeat both side of a disc (for two-sided LDs only)

Press REPEAT B three times.
The REP SIDE A B indicator lights on the display window of the front panel.
Sides A and B are played back repeatedly.

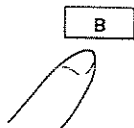
Program Repeat – To repeat a program

Press REPEAT B while the program is being played.

With the program repeat function, you can repeatedly play programmed chapters or tracks in their programmed order.

- See page 34 for details on programming.

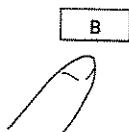
Random Repeat – To repeat a random play (for CDs, CDV discs and LD with TOC)

Press REPEAT B during random playback.

With the random repeat function, you can repeatedly play the chapters or tracks in random order.

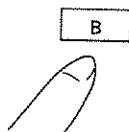
Program Random Repeat – To repeat programmed chapters or tracks in random order

Press REPEAT B during program random playback.

With the program random repeat function, you can repeatedly play programmed chapters or tracks in random order.

- See page 27 for details on program random playback.

TO PLAY ONLY THE DESIRED SCENES/TRACKS – Program Playback

Selected chapters (LD) or tracks (CDV/CD) can be played in any desired order (max. 24 chapters or tracks).

1 Press PGM.

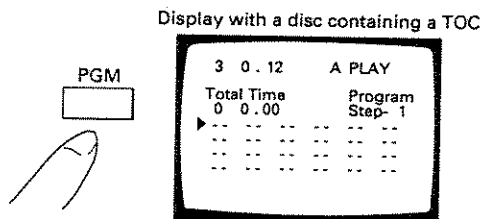

- You can view the state of programming on the monitor TV screen.
- With CDs or CDV discs, the total time of the programmed tracks can be displayed.

2 Select the desired chapters or tracks.

With two-sided LDs, first specify side A or side B with DISC SIDE A or B and then enter the number of the desired chapter with the digit buttons.

Example: To program chapter 9 on side B, chapter 7 on side A, and chapter 18 on side B, in that order:

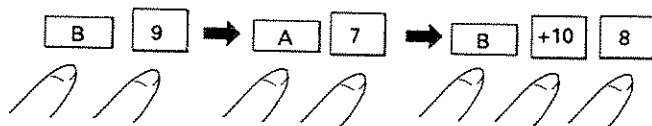

Screen display after programming is completed

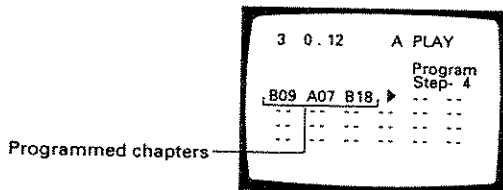

With single-sided LDs, CDs, and CDV discs, just enter the number of the desired chapter or track with the digit buttons.

Example: To program CD tracks 9, 7, and 18 in that order:

If you make a mistake during entry:

Press CLEAR and enter the correct number with the digit buttons.

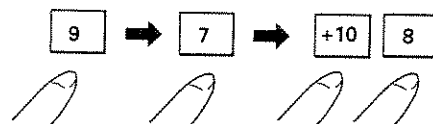

Screen display after programming is completed

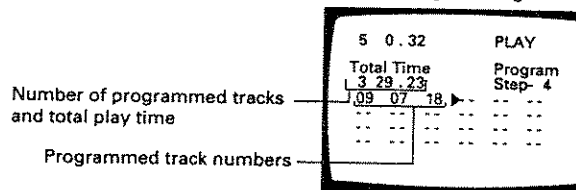

3 Press PLAY ▶.

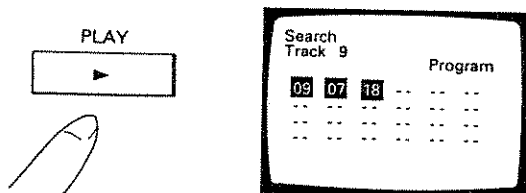

The chapters/tracks are played in the programmed order. When all programmed chapters/tracks have been played, the player enters stop mode.

To stop program play in the middle:

- Press **■** on the front panel of the player or EJECT **■/▲** on the remote control unit.
- Press CLEAR on the remote control unit.

To clear the program contents:

- Open the disc table.
- Press CLEAR on the remote control unit in stop mode.

Programming a pause:

Inserting a pause in your program can be very useful when carrying out recording.

- For example, when recording on both sides of a cassette tape, if you program a pause after the last track to be recorded in the first side, program playback will pause at that point to allow you to switch tape sides.
- Inserting pauses in a program will also allow you to record blank sections on a tape which are useful for music search functions, or to record narration between selections, etc.
- To resume program playback when the unit is in pause mode, press PAUSE **■**.

To program a pause:

In step 2 of the above procedure, press PAUSE **■** instead of entering a chapter or track number.

NOTES:

- A pause cannot be programmed for step 1, and it cannot be programmed for two consecutive steps.
- A pause can be programmed for the last program step, however, it will not be effective.

Programmed pause indication:

On the monitor screen – **■**
In the front panel display window – PA

To check the program contents

During program playback or in stop mode, press PGM to display the program contents on the monitor screen. When PGM is pressed again, the program contents disappear.

To modify the program contents

To erase a programmed chapter/track or pause

- 1 Press PGM.
- 2 Press SKIP ◀◀ or ▶▶ to place the cursor (▶) on the left side of the chapter/track or pause to be erased.
- 3 Press CLEAR.
- 4 Press PGM to complete programming. Pressing PLAY ▶ also completes programming and starts program playback with the new program contents.

To change a programmed chapter/track or pause to a new one

- 1 Press PGM.
 - 2 Press SKIP ◀◀ or ▶▶ to place the cursor (▶) on the left side of the chapter/track or pause to be changed.
 - 3 Enter the new chapter/track number with the digit buttons. Press PAUSE || to enter a pause.
 - 4 Press PGM to complete programming. Pressing PLAY ▶ also completes programming and starts program playback with the new program contents.
- Programmed chapter/track being played cannot be erased or changed.
 - Programmed pause being engaged cannot be erased or changed.

To go to the previous or next chapter (track) in a program:

Press SKIP ◀◀ or ▶▶ on the remote control unit.

Total time display (CD and CDV only):

When programming for CD or CDV, the total time of the programmed tracks is displayed. If the total time exceeds 100 minutes, 100's digit will not be displayed in the display window of the front panel.

- If track No. 33 or more is programmed, the total time will not be displayed.

To view the program contents in the front panel display window:

Programmed chapter/track numbers light up on the visual calendar.

CAUTION

- If the shuttle ring is used to fast-forward or fast-reverse (scan) during Program Playback, the playback position will move to another chapter/track, but when the shuttle ring is returned to its home position, the next chapter/track in the program will be played.
- If ▶ MULTI-SPEED is pressed during program playback, the unit will enter multi-speed playback mode and the playback position will move to successive chapters according to the order of the program.
If ◀ MULTI-SPEED is pressed during program playback, multi-speed playback will begin in the reverse direction but program playback will not be carried out.
- Do not program chapter/track numbers which do not exist on the disc, as this may inhibit execution of the program.

PROGRAMMING CHAPTERS/TRACKS TO BE PLAYED BACK WITHIN A SPECIFIED TIME PERIOD – Compu Program/Auto Program Edit

If the total playing time of both sides of the tape is specified, chapters/tracks are automatically programmed for both sides of the tape.

Compu Program Edit

Chapters/tracks are selected within the designated time, starting from the first track.

Auto Program Edit

The player selects the chapters/tracks so that their total playing time becomes the specified playing time as near as possible.

1 Press EDIT on the front panel.



- With LD discs, after playback is performed, press EDIT.
- When EDIT is pressed during playback, the player enters pause mode.

2 Set the total playing time of both sides of the tape in minutes with the digit buttons (0-9).

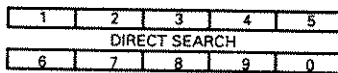

Press two digit buttons rapidly. For example, to enter 46 minutes, press the [4] button and [6] button sequentially.

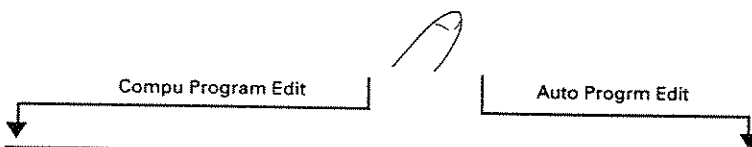

3 Press ►/►◄.

Program playback starts.

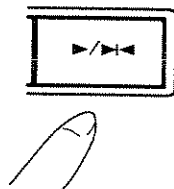

3 Press EDIT again.

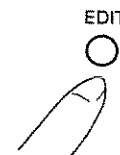

4 Press ►/►◄.

Program playback starts.

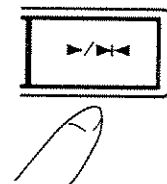

When playback of the first program is completed, the player enters pause mode. To play another program, press ►/►◄.
When all programs have been played, the player enters stop mode.

To clear program contents:

Press CLEAR on the remote control unit.

To specify the first track to be programmed:

Only the track to be played first can be specified.

- 1 Press EDIT.
- 2 Select the desired track by pressing SKIP ◀◀ or ▶▶.
- 3 Set the playing time with the digit buttons.

If the specified time is too short for any track to be programmed:

Programming cannot be performed.

NOTES:

- With discs contained 33 tracks or more, programming may not be correctly performed.
- With Auto Program Edit function, the programmed total playing time is not occasionally close to the specified time compared with Compu Program Edit.
- With LD discs, chapter No. 0 will not be programmed.
- With LD discs, when chapter No. 1 is programmed, the programmed total playing time may slightly differ from the actual calculation. This is not a malfunction.

TROUBLESHOOTING

Incorrect operations are often for trouble and malfunctions. If you think that there is something wrong with this component, check the points below. Sometimes the trouble may lie in another component. Inspect the other components and electrical appliances being used. If the trouble cannot be rectified even after executing the checks listed below, ask your nearest PIONEER authorized service center or your dealer to carry out repair work.

SYMPTOM	CAUSE	REMEDY
1. Disc table is not ejected when OPEN/CLOSE is pressed.	<ul style="list-style-type: none"> ● Power cord is not properly plugged into AC wall socket. ● Power switch is not turned on. 	<ul style="list-style-type: none"> ● Plug in power cord. ● Turn on power switch.
2. Disc table comes out.	<ul style="list-style-type: none"> ● Disc is dirty. ● The disc is not properly set on the disc table. ● Moisture has condensed on parts in the player. ● Disc is warped. 	<ul style="list-style-type: none"> ● Clean disc. ● Set the disc properly. ● Remove disc and let player stand for 1 to 2 hours until it is dry. ● Try to alleviate the warp. (Refer to Symptom 7, remedy column.)
3. Remote control does not work.	<ul style="list-style-type: none"> ● The CONTROL IN terminal on the rear panel is connected to pioneer projection monitor or AV control center. ● Batteries are weak. ● There is an obstacle between the player and the remote control unit. ● Remote control unit is not in a good location for transmission. 	<ul style="list-style-type: none"> ● Aim the remote control unit at the projection monitor or AV control center. ● Replace batteries. ● Remove the obstacle or shift the remote control position. ● Operate the remote control unit in front of the player.
4. Operation of the remote control unit causes the TV to operate improperly.	<ul style="list-style-type: none"> ● Some TV sets have remote control functions that operate improperly in response to the remote control unit of the player. 	<ul style="list-style-type: none"> ● Move the TV and the player further apart, or cover the remote sensor of the TV during disc playback.

TROUBLESHOOTING

WHEN A LASERVISION DISC IS BEING PLAYED

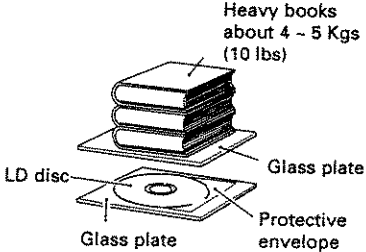
SYMPTOM	CAUSE	REMEDY
5. Disc is rotating but there is no picture.	<ul style="list-style-type: none"> • The TV set is not turned on. • Wrong connections from player to TV. 	<ul style="list-style-type: none"> • Turn on TV. • Make correct connections.
6. Picture continuously moves vertically.	<ul style="list-style-type: none"> • The TV vertical hold control is not adjusted properly. 	<ul style="list-style-type: none"> • Adjust vertical-hold control on TV.
7. Particular disc does not playback properly. The playback stops in the middle of the disc program.	<ul style="list-style-type: none"> • The playing surface of the disc is dirty. • The disc is warped. 	<ul style="list-style-type: none"> • Use a soft cloth and lightly wipe off the dirt from the surface of the disc. If necessary, moisten a cloth with diluted neutral detergent to remove heavy dirt or fingerprints. • LD discs only Put the disc into the protective envelope, then place it on a flat desk top. Subsequently, place a flat board e.g. glass plate on the disc, and load it with about 4 - 5 kgs (about 10 lbs). If it is left in this state for one day, sometimes the warp will alleviated. <div style="text-align: center;">  <p style="text-align: center;">Heavy books about 4 - 5 Kgs (10 lbs)</p> <p style="text-align: center;">Glass plate</p> <p style="text-align: center;">LD disc</p> <p style="text-align: center;">Glass plate</p> <p style="text-align: center;">Protective envelope</p> </div>
8. Sound is unnatural or distorted.	<ul style="list-style-type: none"> • CX system is turned ON for disc which has no mark. 	<ul style="list-style-type: none"> • Press CX to turn CX system OFF.
9. No sound output during playback.	<ul style="list-style-type: none"> • MULTI-SPEED or STILL/STEP playback is being performed. Sound is output only during the normal play mode. The audio signals are not output during other playback modes. 	<ul style="list-style-type: none"> • Press PLAY to set the player to normal play mode.
10. During STILL playback, a part of the screen image shakes.	_____	<ul style="list-style-type: none"> • Even if the disc is a standard play disc, there may be some cases in which a fully still image cannot be obtained, but this does not mean that the player or the disc is defective.
11. CHAPTER SKIP, CHAPTER PROGRAM PLAY and CHAPTER NUMBER SEARCH cannot be performed.	<ul style="list-style-type: none"> • Disc in which no chapter numbers are recorded is loaded. 	<ul style="list-style-type: none"> • Press DISPLAY to check if chapter number is displayed.
12. Certain discs take too long to search for or do not search for.	<ul style="list-style-type: none"> • It takes time to read the recorded code, depending on the disc. 	<ul style="list-style-type: none"> • Press CLEAR and picture will appear. (At this point, a slightly different scene from that which has been searched for may appear.)

TROUBLESHOOTING

SYMPTOM	CAUSE	REMEDY
13. Certain discs take too long to start or do not start.	<ul style="list-style-type: none"> There are errors when the disc code is read (There is no damage to the unit). 	<ul style="list-style-type: none"> Press ■ and stop the playback. Press PLAY ► and start the playback again. (Repeat this operation a few times.)
14. The player takes too long to find point A during A-B (INTERVAL) REPEAT operation.	<ul style="list-style-type: none"> Same as item 12 above. 	<ul style="list-style-type: none"> Same as item 12 above. (The repeat mode is cancelled).
15. Picture other than instructed is searched in TIME NUMBER SEARCH mode.	<ul style="list-style-type: none"> Method of inputting numerals in the TIME NUMBER SEARCH mode differs, depending on whether time number is recorded on disc in hours and minutes or minutes and seconds, as shown below: [e.g.] 12-minute search Disc in which time number is recorded in hours and minutes <div style="text-align: center;"> <p style="text-align: center;">"minutes"</p> </div> <ul style="list-style-type: none"> Disc in which time number is recorded in minutes and seconds <div style="text-align: center;"> <p style="text-align: center;">"minutes" "seconds"</p> </div>	

TROUBLESHOOTING

WHEN PLAYING BACK A COMPACT DISC

SYMPTOM	CAUSE	REMEDY
16. Player stops immediately after playback is started.	<ul style="list-style-type: none"> ● Disc is loaded upside down (CD, CDV, onesided LD discs). ● The playing surface of the discs is dirty. ● Disc is not properly set on the disc table. 	<ul style="list-style-type: none"> ● Load the disc correctly with the label side upward. ● Use a soft cloth and lightly wipe off the dirt from the surface of the disc. If necessary, moisten a cloth with diluted neutral detergent to remove heavy dirt or fingerprint. ● Set the disc properly.
17. No sound output	<ul style="list-style-type: none"> ● The stereo amplifier is not correctly connected. ● You are not operating the stereo amplifier correctly. ● The connection terminals and/or the plugs of the connection cords are dirty. ● The plugs of the connection cords are disconnected, or are not fully pushed in. ● The player is in pause mode. 	<ul style="list-style-type: none"> ● Connect the amplifier correctly. ● Refer to the operating instructions for the amplifier, and operate the amplifier correctly. ● Clean the plugs and terminals and connect again. ● Make sure that connections are made correctly. ● Press PLAY ► and restore the player to play mode.
18. Sound is distorted.	<ul style="list-style-type: none"> ● The audio output jacks are connected to the PHONO jacks. ● The connection terminals and/or the plugs of the connection cords are dirty. ● The plugs of the connection cords are not fully pushed in. 	<ul style="list-style-type: none"> ● Connect to the AUX, CD, VDP, LD or VCR jacks. ● Clean the plugs and terminals and connect again. ● Push the plug in firmly.

Abnormal functioning of this unit may be caused by lightning, static electricity, or other external interference. To restore normal operation, turn the power off and then on again, or unplug the AC power cord and then plug it in again.

SPECIFICATIONS

1. General

System	LaserVision Disc system and Compact Disc digital audio system
Laser	Semiconductor laser wavelength 780 nm
Power requirements	
U.S. and Canadian models	AC 120V, 60 Hz
Multi voltage models	AC 110 - 127 V/220 - 240 V (Switchable), 50/60 Hz
Power consumption	
U.S. and Canadian models	50 W
Multi voltage models	50 W
Weight	8.6 kg (19 lbs)
Dimensions	420 (W) x 438 (D) x 137 (H) mm 16-9/16 (W) x 17-1/4 (D) x 5-3/8 (H) in
Operating temperature	+5°C ~ +35°C (41°F - 95°F)
Operating humidity	5% ~ 90% (There should be no condensation of moisture.)

2. Disc

LaserVision Discs

*Maximum playing times

12-inch standard play disc	1 hour/both sides
12-inch extended play disc	2 hours/both sides
8-inch standard play disc	28 min/both sides 14 min/one side
8-inch extended play disc	40 min/both sides 20 min/one side

Spindle motor speed

Standard play disc	1,800 rpm
Extended play disc	1,800 rpm (inner circumference) to 600 rpm (outer circumference) (For a 12-inch disc)

Compact Discs

DISC	Diameter: 5-inch, 3-inch, Thickness: 1.2 mm
Rotation direction (pickup side)	Counterclockwise
Liner speed	1.2 ~ 1.4m/sec

*Maximum playing time

74 min. 5-inch discs
20 min. 3-inch discs
(For stereo playback)

Compact Discs with Video

Disc	Diameter: 5-inch, Thickness: 1.2 mm
Rotation direction (pickup side)	Counterclockwise
Linear speed	Audio portion: 1.2 ~ 1.4m/sec Video portion: 11 ~ 12m/sec
Maximum playing time	Video portion: 5 min. (CLV) Audio portion: 20 min. (Digital)

* Actual playback time differs for each disc.

3. Video characteristics

Format	NTSC specifications
Video output	
Level	1 Vp-p nominal, sync. negative, terminated
Impedance	75Ω unbalanced
Jacks	Both RCA jacks

5. S-Video output

Y (luminance) - Output level	1 Vp-p (75 Ω)
C (color) - Output level	286 mVp-p (75 Ω)
Jack	S-VIDEO jack

4. Audio characteristics

Output level	
During analog audio output	200 mVrms (1 kHz, 40%)
During digital audio output	200 mVrms (1 kHz, -20 dB)
Jacks	Both RCA jacks
Number of channels	2

Digital Audio Characteristics

Frequency response	4 Hz - 20 kHz (±0.2 dB) (EIAJ)
SN ratio	115 dB (EIAJ)
Dynamic range	99 dB (EIAJ)
Channel separation	105 dB (EIAJ)
Total harmonic distortion	0.0018% (EIAJ)
Wow and flutter	Limit of measurement (EIAJ)

5. Other Terminals

Control input/output	Both miniature jacks
CD-DECK synchro	Miniature jack
Optical digital output	Optical digital jack

6. Accessories

Remote control unit (CU-CLD038)	1
Size "AAA" (IEC R03) dry cell batteries	2
Video cord	1
Audio cord	1
Operating instructions	1
Warranty card	1

SPECIFICATIONS

7. Functions

Remote control unit operations (CU-CLD038)

	Function	Standard play Disc (CAV)	Extended play Disc (CLV)	Compact Disc with Video	Compact Disc
Basic Functions	Two-side play Single-side play Pause Stop	YES YES YES YES	YES YES YES YES	NO YES YES YES	NO YES YES YES
Search	Fast forward (forward and reverse) Chapter/Track skip Direct chapter/Track number search Frame number search Time number search Absolute time search	YES YES YES YES NO NO	YES YES YES NO YES NO	YES YES YES NO YES NO	YES YES YES NO YES YES
Program	Chapter/Track program play Program correction	YES YES	YES YES	YES YES	YES YES
Repeat	Repeat between 2 points Memory repeat Chapter/Track repeat One-side repeat Two-side repeat Program repeat Random repeat Program random repeat	YES YES YES YES YES YES YES*1 YES	YES YES YES YES YES YES YES*1 YES	YES YES YES YES NO YES YES YES	YES YES YES YES NO YES YES YES
Trick play	Still/Step Multi-speed (Forward/reverse 9-level variable) Still with Sound Strobe motion Jog dial/Shuttle ring	YES YES YES YES YES	YES YES YES YES YES	YES*5 YES*5 YES*5 YES*5 YES	NO NO NO NO YES
Time display	Elapsed time display Absolute time display Remaining track time display Remaining total time display Total number of selections, total time display	NO YES*1 NO YES*1 YES*1	YES NO NO YES*1 YES*1	YES NO YES YES YES	YES YES YES YES YES
Others	CX system ON/OFF AUTO DIGITAL/ANALOG switch One-shot memory Audio channel selection (Stereo, 1/L, 2/R)	YES*2 YES*3 YES YES	YES*2 YES*3 YES YES	NO NO YES*5 YES	NO NO NO YES

*1 Only discs with TOC

*2 Valid for analog sound playing a disc with the  mark.

*3 Can only be used with discs with digital sound tracks.

*4 Audio part only

*5 Video part only

NOTE:

The specifications and design of this product are subject to change without notice, due to improvement.

PLAYER FUNCTIONS

- Display ON/OFF, Visual Calendar Display
- Intro Scan, Direct CD, Single Play, Peak Search, Random Playback and Compu Program/Auto Program Edit
- Digital Sound for LaserVision Discs
- Last Memory