

# Operating Instructions

CD CDV LD PLAYER

# CLD-A100

**LaserDisc**

NTSC

COMPACT  
**disc**  
DIGITAL AUDIO

**L**  
LASER DISC

- This player does not apply to business use.

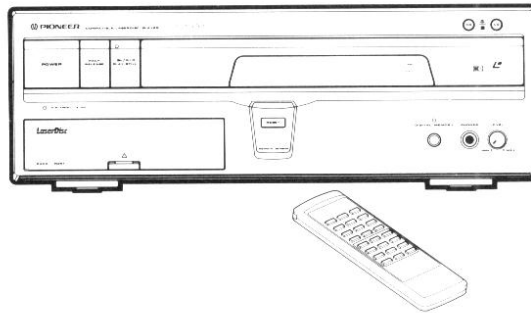

Thank you for buying this Pioneer product. Please read through these operating instructions so you will know how to operate your model properly. After you have finished reading the instructions, put them away in a safe place for future reference. In some countries or regions, the shape of the power plug and power outlet may sometimes differ from that shown in the explanatory drawings. However, the method of connecting and operating the unit is the same.

**WARNING:** TO PREVENT FIRE OR SHOCK HAZARD. DO NOT EXPOSE THIS APPLIANCE TO RAIN OR MOISTURE.

### IMPORTANT NOTICE

[For U.S and Canadian models]

The serial number for this equipment is located on the rear panel. Please write this serial number on your enclosed warranty card and keep it in a secure area. This is for your security.

[For Canadian models]

**CAUTION:** TO PREVENT ELECTRIC SHOCK DO NOT USE THIS (POLARIZED) PLUG WITH AN EXTENSION CORD, RECEPTACLE OR OTHER OUTLET UNLESS THE BLADES CAN BE FULLY INSERTED TO PREVENT BLADE EXPOSURE.

**ATTENTION:** POUR PREVENIR LES CHOCS ELECTRIQUES NE PAS UTILISER CETTE FICHE POLARISEE AVEC UN PROLONGATEUR UNE PRISE DE COURANT OU UNE AUTRE SORTIE DE COURANT, SAUF SI LES LAMES PEUVENT ETRE INSEREES A FOND SANS EN LAISSER AUCUNE PARTIE A DECOUVERT.

**CAUTION:** Be sure to use the shielded cables when connecting this equipment to other devices.

**PIONEER**  
The Art of Entertainment

## IMPORTANT



The lightning flash with arrowhead, within an equilateral triangle, is intended to alert the user to the presence of uninsulated "dangerous voltage" within the product's enclosure that may be of sufficient magnitude to constitute a risk of electric shock to persons.



**CAUTION:**  
**TO PREVENT THE RISK OF ELECTRIC SHOCK, DO NOT REMOVE COVER (OR BACK). NO USER-SERVICEABLE PARTS INSIDE. REFER SERVICING TO QUALIFIED SERVICE PERSONNEL.**



The exclamation point within an equilateral triangle is intended to alert the user to the presence of important operating and maintenance (servicing) instructions in the literature accompanying the appliance.

## SAFETY INSTRUCTIONS

**READ INSTRUCTIONS** – All the safety and operating instructions should be read before the appliance is operated.

**RETAIN INSTRUCTIONS** – The safety and operating instructions should be retained for future reference.

**HEED WARNINGS** – All warnings on the appliance and in the operating instructions should be adhered to.

**FOLLOW INSTRUCTIONS** – All operating and use instructions should be followed.

**CLEANING** – Unplug this video product from the wall outlet before cleaning. Do not use liquid cleaners or aerosol cleaners. Use a damp cloth for cleaning.

**ATTACHMENTS** – Do not use attachments not recommended by the video product manufacturer as they may cause hazards.

**WATER AND MOISTURE** – Do not use this video product near water – for example, near a bathtub, wash bowl, kitchen sink, or laundry tub, in a wet basement, or near a swimming pool, etc.

**ACCESSORIES** – Do not place this video product on an unstable cart, stand, tripod, bracket, or table. The video product may fall, causing serious injury to a child or adult, and serious damage to the appliance. Use only with a cart, stand, tripod, bracket, or table recommended by the manufacturer, or sold with the video product. Any mounting of the appliance should follow the manufacturer's instructions, and should use a mounting accessory recommended by the manufacturer.

**CART** – An appliance and cart combination should be moved with care. Quick stops, excessive force, and uneven surfaces may cause the appliance and cart combination to overturn.



**VENTILATION** – Slots and openings in the cabinet are provided for ventilation and to ensure reliable operation of the video product and to protect it from overheating. These openings must not be blocked or covered. They should never be blocked by placing the video product on a bed, sofa, rug, or other similar surface. This video product should never be placed near or over a radiator or heat register. This video product should not be placed in a built-in installation such as a bookcase or rack unless proper ventilation is provided or the manufacturer's instructions have been adhered to.

**POWER SOURCES** – This video product should be operated only from the type of power source indicated on the marking label. If you are not sure of the type of power supply to your home, consult your appliance dealer or local power company. For video products intended to operate from battery power, or other sources, refer to the operating instructions.

### POWER-CORD PROTECTION

Power-supply cords should be routed so that they are not likely to be walked on or pinched by items placed upon or against them. Pay particular attention to cords at plugs, convenience receptacles, and the point where they exit from the appliance.

**POLARIZATION** – This video product is equipped with a polarized alternating current line plug (a plug having one blade wider than the other). This plug will fit into the power outlet only one way. This is a safety feature. If you are unable to insert the plug fully into the outlet, try reversing the plug. If the plug should still fail to fit, contact your electrician to replace your obsolete outlet. Do not defeat the safety purpose of the polarized plug.

**LIGHTNING** – For added protection for this video product receiver during a lightning storm, or when it is left unattended and unused for long periods of time, unplug it from the wall outlet and disconnect the antenna or cable system. This will prevent damage to the video product due to lightning and power-line surges.

**POWER LINES** – An outside antenna system should not be located in the vicinity of overhead power lines or other electric light or power circuits, or where it can fall into such power lines or circuits. When installing an outside antenna system, extreme care should be taken to keep from touching such power lines or circuits as contact with them might be fatal.

**OVERLOADING** – Do not overload wall outlets and extension cords as this can result in the risk of fire or electric shock.

**OBJECT AND LIQUID ENTRY** – Never push objects of any kind into this video product through openings as they may touch dangerous voltage points or short-out parts that could result in a fire or electric shock. Never spill liquid of any kind on the video product.

**SERVICING** – Do not attempt to service this video product yourself as opening or removing covers may expose you to dangerous voltage or other hazards. Refer all servicing to qualified service personnel.

### DAMAGE REQUIRING SERVICE

Unplug this video product from the wall outlet and refer servicing to qualified service personnel under the following conditions:

a. When the power-supply cord or plug is damaged.

b. If liquid has been spilled, or objects have fallen into the video product.

c. If the video product has been exposed to rain or water.

d. If the video product does not operate normally by following the operating instructions. Adjust only those controls that are covered by the operating instructions. Improper adjustment of other controls may result in damage and will often require extensive work by a qualified technician to restore the video product to its normal operation.

e. If the video product has been dropped or the cabinet has been damaged.

f. When the video product exhibits a distinct change in performance – this indicates a need for service.

**REPLACEMENT PARTS** – When replacement parts are required, be sure the service technician has used replacement parts specified by the manufacturer or having the same characteristics as the original part. Unauthorized substitutions may result in fire, electric shock or other hazards.

**SAFETY CHECK** – Upon completion of any service or repairs to this video product, ask the service technician to perform safety checks to determine that the video product is in proper operating condition.

**OUTDOOR ANTENNA GROUNDING** – If an outside antenna is connected to the antenna terminal, be sure the antenna system is grounded so as to provide some protection against voltage surges and built-up static charges.

In the U.S.A., section 810 of the National Electrical Code, ANSI/NFPA 70, provides information with respect to proper grounding of the mast and supporting structure, grounding of the lead-in wire to an antenna discharge unit, size of grounding conductors, location of antenna-discharge unit, connection to grounding electrodes, and requirements for the grounding electrode.

See Fig. A.

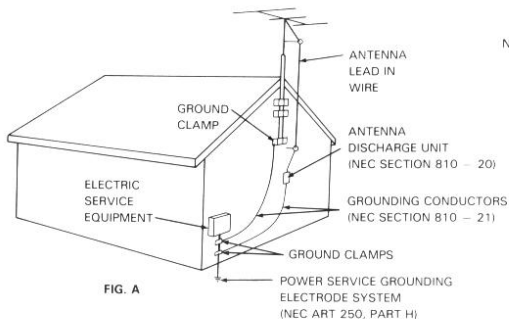

NEC – NATIONAL ELECTRIC CODE

### CAUTION

- Use of controls or adjustments or performance of procedures other than those specified herein may result in hazardous radiation exposure.
- The use of optical instruments with this product will increase eye hazard.

### Information to User

Alteration or modifications carried out without appropriate authorization may invalidate the user's right to operate the equipment.

This equipment has been tested and found to comply with the limits for a Class B digital device, pursuant to Part 15 of the FCC Rules. These limits are designed to provide reasonable protection against harmful interference in a residential installation. This equipment generates, uses, and can radiate radio frequency energy and, if not installed and used in accordance with the instructions, may cause harmful interference to radio communications. However, there is no guarantee that interference will not occur in a particular installation. If this equipment does cause harmful interference to radio or television reception, which can be determined by turning the equipment off and on, the user is encouraged to try to correct the interference by one or more of the following measures:

- Reorient or relocate the receiving antenna.
- Increase the separation between the equipment and receiver.
- Connect the equipment into an outlet on a circuit different from that to which the receiver is connected.
- Consult the dealer or an experienced radio/TV technician for help.

### NOTE TO CATV SYSTEM INSTALLER

THIS REMINDER IS PROVIDED TO CALL THE CATV SYSTEM INSTALLER'S ATTENTION TO ARTICLE 820-40 OF THE NEC THAT PROVIDES GUIDELINES FOR PROPER GROUNDING AND, IN PARTICULAR, SPECIFIES THAT THE CABLE GROUND SHALL BE CONNECTED TO THE GROUNDING SYSTEM OF THE BUILDING, AS CLOSE TO THE POINT OF CABLE ENTRY AS PRACTICAL.

- This player may be used with LaserVision Disc, Compact Discs, and Compact Discs with Video bearing the following symbols:

[LASERDISC SYSTEM]/[LaserVision Disc]\*



This is the unified symbol mark of LASERDISC (Laser-Vision videodisc).

- \* LaserVision players and discs which bear this symbol and use the same television system, are mutually compatible.



(3-inch Compact Disc) \*\* Digital Audio with Multi Audio Discs (CD VIDEO LD) and a CDV (CD Video CDV) are referred to as CD Video discs. CD Videodiscs are recorded with subcodes, which are the non-audio recordings of TOC data such as track numbers, index numbers, etc. However, there are some discs without these marks.



Only one disc can be loaded at any one time. Loading a LaserVision Disc, a Compact Disc, a 3-inch Compact Disc or a Compact Disc with Video on top of one another may result in breakdown, or in scratching of the discs. Please only load one disc at a time.

This player is to be used exclusively with the NTSC color system. Please use NTSC LaserVision Disc or NTSC Compact Disc with Video only. PAL and SEC-AM system discs cannot be used with this player.

## CONTENTS

<p>ACCESSORIES ..... 5</p> <p>PRECAUTIONS ..... 6</p> <p>FEATURES AND FUNCTIONS OF THE PLAYER ..... 7</p> <p>TYPES OF DISCS THAT CAN BE PLAYED WITH THIS UNIT ..... 8</p> <p>CARE OF DISCS ..... 10</p> <p>CONNECTIONS ..... 11</p> <p>NAMES AND FUNCTIONS OF FRONT PANEL COMPONENTS ..... 16</p> <p>NAMES AND FUNCTIONS OF REMOTE CONTROL UNIT COMPONENTS ..... 18</p>	<p>NAMES AND FUNCTIONS OF THE REAR PANEL COMPONENTS ..... 19</p> <p>DISPLAY SWITCHING ..... 20</p> <p>TO PLAY AN LD, CDV OR CD ..... 22</p> <p>TO SEARCH FOR A PARTICULAR CHAPTER/TRACK ..... 26</p> <p>TO SEARCH FOR A PARTICULAR TIME/FRAME ..... 27</p> <p>TO SEARCH FOR A PARTICULAR PASSAGE ..... 28</p> <p>TROUBLESHOOTING ..... 29</p> <p>SPECIFICATIONS ..... 32</p>
---	--



### *Dear Customer:*

Selecting fine audio equipment such as the unit you've just purchased is only the start of your musical enjoyment. Now it's time to consider how you can maximize the fun and excitement your equipment offers. This manufacturer and the Electronic Industries Association's Consumer Electronics Group want you to get the most out of your equipment by playing it at a safe level. One that lets the sound come through loud and clear without annoying blaring or distortion—and, most importantly, without affecting your sensitive hearing.

Sound can be deceiving. Over time your hearing "comfort level" adapts to higher volumes of sound. So what sounds "normal" can actually be loud and harmful to your hearing. Guard against this by setting your equipment at a safe level **BEFORE** your hearing adapts.

**To establish a safe level:**

- Start your volume control at a low setting.
- Slowly increase the sound until you can hear it comfortably and clearly, and without distortion.

**Once you have established a comfortable sound level:**

- Set the dial and leave it there.

Taking a minute to do this now will help to prevent hearing damage or loss in the future. After all, we want you listening for a lifetime.

### We Want You Listening For A Lifetime

Used wisely, your new sound equipment will provide a lifetime of fun and enjoyment. Since hearing damage from loud noise is often undetectable until it is too late, this manufacturer and the Electronic Industries Association's Consumer Electronics Group recommend you avoid prolonged exposure to excessive noise. This list of sound levels is included for your protection.

**Decibel**

Level	Example
30	Quiet library, soft whispers
40	Living room, refrigerator, bedroom away from traffic
50	Light traffic, normal conversation, quiet office
60	Air conditioner at 20 feet, sewing machine
70	Vacuum cleaner, hair dryer, noisy restaurant
80	Average city traffic, garbage disposals, alarm clock at two feet.

**THE FOLLOWING NOISES CAN BE DANGEROUS UNDER CONSTANT EXPOSURE**

90	Subway, motorcycle, truck traffic, lawn mower
100	Garbage truck, chain saw, pneumatic drill
120	Rock band concert in front of speakers, thunderclap
140	Gunshot blast, jet plane
180	Rocket launching pad

Information courtesy of the Deafness Research Foundation.



## ACCESSORIES

When unpacking the player, first check to make sure that all of the accessories listed below are supplied.

- Remote control unit
- Size "AAA" (IEC R03) dry cell battery × 2

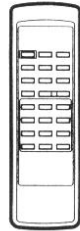

- Video cord (Pin plug ↔ Pin plug)  
Use to connect the player to a color monitor etc.



- Audio cord (Pin plug × 2 ↔ Pin plug × 2)  
Use to connect the player to a stereo amplifier etc.

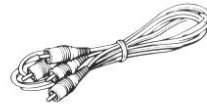

- Operating instructions
- Warranty card

### INSERTING BATTERIES INTO THE REMOTE CONTROL UNIT

- 1 Open the battery compartment cover on the back of the remote control unit. Press the knob and open the cover in the direction of the arrow.
- 2 Take out the two accessory size "AAA" (IEC R03) dry cell batteries, and insert them into the battery compartment in accordance with the display (+, -) inside the compartment.
- 3 Close the cover of the battery case.

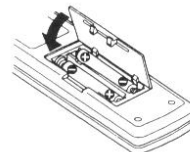
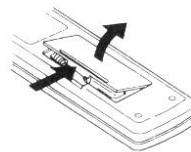

Incorrect use of batteries may cause leakage or rupture.

Always be sure to follow these guidelines:

- A. Always insert batteries into the battery compartment correctly matching the positive (+) and negative (-) polarities, as shown by the display inside the compartment.
- B. Never mix new and used batteries.
- C. Batteries of the same size may have different voltages, depending on brand. Do not mix different brands of batteries.

## PRECAUTIONS

### During playback do not move the unit in any way.

During playback the disc is revolving at a high speed, so the unit should not be lifted or moved. The disc may be damaged if the unit is moved at this time.

### TRANSPORTING THE APPLIANCE

Before packing the appliance for transporting, moving etc., be sure the Control Pack and disc are detached. Switch OFF the power supply by the remote control unit power button. While the standby indicator illuminates red, switch OFF the power supply by the power switch on the front panel of the appliance and remove the power cord.

### INSTALLING THE PLAYER

- Place the player on a stable platform next to the television and stereo system to be used with the player.
- When using the player with a stereo system, your speakers should be placed away from your television (or TV monitor).
- Do not place heavy objects such as a television or TV monitor on top of the player.
- Do not place the player on top of your TV set or TV monitor. Also, keep the player away from devices such as cassette decks which are sensitive to magnetic fields.

When FM or AM stations are being received, signal noise may be generated if the player is turned on. Turn off the player when not in use. Also, if there is signal noise when receiving radio stations with an indoor antenna adjust the position or direction of the antenna.

### INSTALL THE PLAYER IN A WELL VENTILATED PLACE AWAY FROM HEAT AND HUMIDITY

Do not install the player in a location subject to direct sunlight, or near a stove or radiator etc. This could adversely affect the cabinet and internal components. Also avoid installing the player in a humid or dusty location. This could result in a malfunction or accident. Do not install near a cookstove where the player could be affected by smoke, steam, or heat.

### AVOID SOURCES OF HEAT

Do not put the player on sources of heat, such as an amplifier. When installing with audio components on a rack, avoid components generate heat, by placing the player below such components where there is adequate ventilation and not much dust. Avoid placing the player on surfaces such as shaggy carpets, beds, and sofas which may block ventilation under the player and cause damage.

### CAUTIONS FOR AUTOMATIC LOADING OPERATIONS

Since this player has an automatic loading construction, use the button on the player or the remote control unit for opening and closing of the disc table. To avoid damage, be careful not to apply any force to the moving disc table.

Even when the player is in the pause mode, the disc-drive motor is still revolving. Since leaving the player in this condition can shorten the lifetime of the motor, do not leave the player in the pause mode for long periods of time. Also, do not use the unit for long periods of time under conditions in which the screen display (monitor) has been displayed characters (for example, power-ON mode, CD PLAY, PAUSE).

### Take the following precautions to avoid accidents !

Be careful not to catch your finger in the disc table section while the disc table is being retracted into the unit. Also, be careful that children do not put their hands into the inside of the unit while the disc table is open. This may cause injury.

### STRIPE PATTERNS APPEARING ON A TV PROGRAM

Stripe patterns may appear during a TV program if the player unit is turned on, depending on the quality of reception of the TV station. This is neither a malfunction of the television nor the player. If stripes appear while watching the TV, or when watching the TV for long periods of time, turn the player off.

### CONDENSATION

Moisture will form in the operating section of the player if the player is brought from cool surroundings into a warm room or if the temperature of the room rises suddenly. When this happens, player's performance will be impaired.

To prevent this, let the player stand in its new surroundings for about an hour before switching it on, or make sure that the room temperature rises gradually.

The same, symptoms of condensation may be caused during summer, if the player is exposed to the breeze from an air conditioner. In such cases change the location of the player.

### POWER-CORD CAUTION

Handle the power cord by the plug. Do not pull out the plug by tugging the cord and never touch the power cord when your hands are wet as this could cause a short circuit or electric shock. Do not place the unit, a piece of furniture, etc., on the power cord, or pinch the cord. Never make a knot in the cord or tie it with other cords. The power cords should be routed such that they are not likely to be stepped on. A damaged power cord can cause fire or give you an electrical shock. Check the power cord once in a while. When you find it damaged, ask your nearest PIONEER authorized service center or your dealer for a replacement.

### CLEANING CARE

Use a soft, dry cloth for cleaning. For stubborn dirt, soak the cloth in a solution of household detergent diluted using 1 part detergent to five or six parts water; wring well first and wipe. Use a dry cloth to wipe it dry. Do not use any volatile agents such as benzene or paint thinner, as they may damage the surface of the player.

### WARNING!

Still pictures or images, such as those generated by video-games, can cause permanent damage to projection TV's. We recommend that this product not be used with a large-screen projection TV.

## FEATURES AND FUNCTIONS OF THE PLAYER

### LASERACTIVE COMPATIBILITY

The LaserActive can be enjoyed even further by installing a separately sold Control Pack (PAC-N10 or PAC-S10)\*.

The LaserActive can be richly enjoyed by creating a virtual reality in which the user can personally participate. For example, by matching the game software with the images (pictures) of the Laser Discs, the game has greater realistic appeal.

\* For the LaserActive, the PAC-N10 Control Pack compatible with NEC corporation "TurboChips" and TurboGrafx-16 games, and the PAC-S10 Control Pack compatible with SEGA Enterprises, Ltd "SEGA GENESIS" and "SEGA CD" games, are available.

### LASER KARAOKE COMPATIBILITY

Laser Karaoke can be enjoyed by installing the separately sold Control Pack (PAC-K1).

### SEARCHING FOR A DESIRED SCENE

A multitude of convenient search functions are arranged for searching of desired scenes. There are Direct Search, Chapter/Track Search, Chapter Skip, Time Number Search and Frame Number Search functions available. For further details, see "TO SEARCH FOR A PARTICULAR CHAPTER/TRACK" (page 26).

### CD DISC TABLE

In the center of the disc table, only the CD disc table opens and closes, allowing the unit to be operated as a CD player. Furthermore, when playing back a CD, the time taken from pressing the "PLAY/STILL" ►/▶ button to when the sound transpires is shortened in comparison to a conventional LD/CD disc table.

### VARIOUS DISC COMPATIBILITY

Naturally, normal LDs (12-inch, 8-inch), CDs (5-inch) and CDVs (5-inch), but also thin-type 8-inch LD and 3-inch CDs can be played back without an adaptor.







### CANCELING PICTURE-STOP

In discs where a picture stop code has been entered, during playback the picture becomes still, however, when you do not want the picture to stop, the canceling of the picture-stop can be done in advance. (Press the PLAY/STILL ►/▶ button on the front panel for more than 3 seconds.)

## TYPES OF DISCS THAT CAN BE PLAYED WITH THIS UNIT

This unit is a CD VIDEO SYSTEM (\*1) compatible player which can play CDs, CDV discs, and LDs. The five disc types listed in the table below can be played with this unit.

• The marks shown in the left column are printed on the labels and jackets of the corresponding discs.

Mark	Disc	Size	Number of recorded sides	Audio recording system	Video recording system	Other
	CD (Compact Disc) Single	3-inch	One side	Digital (20 minutes max.)	—	TOC (*2)
	CD (Compact Disc)	5-inch	One side	Digital (74 minutes max.)	—	TOC
 or 	VIDEO SINGLE DISC  CD VIDEO SINGLE	5-inch	One side	Digital (5 minutes max.)	CLV (*3) (5 minutes max.)	TOC *
	CDV (CD with video)	5-inch	One side	Digital (20 minutes max./ 5 minutes max.)	CLV (*3) (5 minutes max.)	TOC *
	CD VIDEO LD (*4)	12-inch, 8-inch	Two sides, one side	Digital/analog	CAV (*5), CLV	TOC **
 	LD (LASERDISC/ LaserVision Disc)	12-inch, 8-inch	Two sides, one side	Digital/analog (*6) or analog only	CAV, CLV	—

\* There are some discs marked with the "LD" mark instead of the "CD VIDEO" mark.  
 \*\* There are some discs without the "LD" mark.

### LD GLOSSARY

#### Chapter number

Chapter numbers are used to indicate the boundaries of the sections on a disc similar to the "chapters" in a book. If chapter numbers are recorded on a disc, it is so indicated on the jacket of the disc, etc. Chapter numbers can be used to search for desired chapters (Chapter Search).

#### Frame number

Frame numbers are the numbers assigned to each picture frame on a CAV(standard play) disc. Frame numbers can be used to search for desired frames (Frame Search).

#### Time number

Time numbers indicate the time elapsed from the beginning of a CLV(extended play) disc. Time numbers can be used to search for desired scenes (Time Search).

### CDV/CD GLOSSARY

#### Track number

Track numbers indicate the boundaries of the sections, or "tracks", on a disc. Track numbers are assigned consistently throughout the audio part and video part of a CDV disc. Track numbers can be used to search for desired tracks (Track Search).

#### TOC (\*2)

Every CD/CDV-type disc is provided with a section called TOC (Table Of Contents) at the beginning of the disc. The TOC section is just like the table of contents of a book and contains information on the contents (number of tracks, playing time, etc.) of the disc.

- Some LD discs are also provided with a TOC section.



## TYPES OF DISCS THAT CAN BE PLAYED WITH THIS UNIT

### CD VIDEO SYSTEM (\* 1)

The CD VIDEO SYSTEM is the standard name for the "optical video disc with digital audio" system that encompasses both LDs and CDV discs.

The following mark is the standard mark for the CD VIDEO SYSTEM and is found on all players and discs which conform to the CD VIDEO SYSTEM format.

The following systems are included in the CD VIDEO SYSTEM:



- CDV (CD VIDEO CDV) discs
- LaserVisionDiscs (CD VIDEO LDs) containing digital sound with sub-codes
- CD CDV LD players which can play CDs, CDV discs, and LDs

### CD VIDEO LDs (\*4)

A CD VIDEO LD is an LD with digital audio which is encoded with sub-codes (data such as TOC and track number data, excluding audio and video signals).

### LDs (LASERDISCS)

With this unit, only play LaserDiscs which bear the following mark.



This mark is the standard mark for LaserDiscs.

Players and discs which bear the LaserVision mark are mutually compatible as long as they conform to the same television system.

Two types of standard LaserDisc are available — standard play (CAV) (\* 5) discs and extended play (CLV) (\* 3) discs — which differ with respect to their signal recording systems.

### CAV (\*5) DISCS

The jackets and labels of these discs are marked with a "Standard Play Disc CAV" or "Standard Play" indication.

Frames are recorded on these discs at a ratio of one frame per disc revolution, and the discs are played at a fixed rotational speed (CAV = Constant Angular Velocity) of 1,800 rpm. This system is well suited to special playback modes such as still frame playback and multi-speed playback. One side of a CAV disc can have a playback time of up to 30 minutes (for a 12-inch disc), which is equivalent to 54,000 frames. Each frame — from frame 1 to frame 54,000 — is encoded with its own frame number.

\* Playback time varies according to the contents of the disc.

### CLV (\*3) DISCS

The jackets and labels of these discs are marked with a "Extended Play Disc CLV" or "Extended Play" indication.

Signals are recorded on these discs at a constant linear velocity (CLV), and the rotational speed during playback varies from 1,800 rpm for the innermost track to 600 rpm for the outermost track. As a result, one side of a CLV disc can have a playback time of up to 60 minutes (for a 12-inch disc), which is twice as long as a standard play (CAV) disc. CLV discs are encoded with time numbers which correspond to the elapsed play time from the beginning of the disc.

\* Playback time varies according to the contents of the disc.

### LASERVISION DISCS WITH DIGITAL AUDIO (\*6)

The jackets and labels of these discs bear the following marks.



These are LaserDiscs which contain digital audio signals in addition to conventional analog audio signals. This feature allows the high image quality of LaserDiscs to be enjoyed together with the superior quality of digital sound. The digital and analog audio signals are recorded on the disc using different frequency bands.

### LASERVISION MULTI AUDIO DISCS WITH DIGITAL AUDIO

The jackets and labels of these discs bear the following marks.



These are LaserDiscs in which the recorded digital and analog audio signals differ in content. This allows the user to enjoy two different audio soundtracks by switching between the digital and analog sound.

### CDV (COMPACT DISC WITH VIDEO) DISCS

- These are compact discs which also contain video signals. Of the total 25-minute playback time of a CDV disc, 20 minutes is encoded with conventional CD digital audio signals (the "audio part"). The remaining 5 minutes is encoded with both video and digital audio signals (the "video part").
- The CD Video Single is recorded with a maximum of 5 minutes of video and digital audio signals.

## CARE OF DISCS

### How to hold discs

When loading or removing discs, try not to touch their playing surfaces.

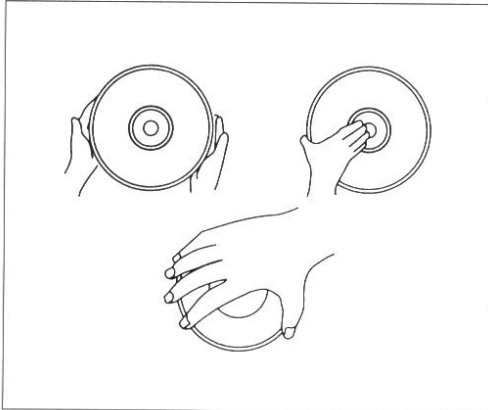

### Cleaning

Fingerprints or other dirt on the disc may affect sound and picture quality.

To clean your discs, use a soft clean cloth to wipe them. If necessary, moisten a soft cloth with diluted neutral detergent to remove heavy dirt or fingerprints.



Do not wipe in a circular direction



Gently wipe from the inside toward the outer edge

Discs must not be cleaned with record cleaning sprays, or static prevention sprays, etc. Also do not use volatile liquids such as benzene, or thinners, etc.

### NEVER PLAY CRACKED OR WARPED DISCS

■ The disc revolves on the player at a high speed when it is played. Never play a cracked, scratched or warped disc. This may damage the player or cause it to malfunction.



### After using discs, store them upright.

After playing a disc, always remove it from the player and return it to its jacket. Then store it standing upright away from heat and humidity.

- Store discs carefully. If you store discs at an angle, or stacked on top of each other, discs may become warped even when in their jackets.
- Do not leave discs in locations such as the seat of a car which may become excessively hot.

### If an LD disc is warped ...

If an LD disc is warped, put the disc into its protective envelope, and then place it between two flat plates of glass. Then place heavy books on top of the plates so that approximately 4 to 5 kgs (10 lbs) is applied. Leave the disc like this for a day or so. This may correct the warp.

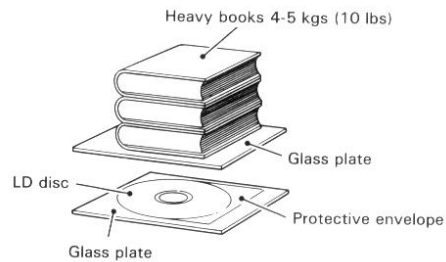

### CAUTION WHEN USING THE DISC

All rights reserved.

Unauthorized public performance, broadcasting or copying is a violation of applicable laws.

## CONNECTIONS

- Only televisions equipped with a video input can be connected to this unit.

### USING TELEVISION WITH AUDIO AND VIDEO JACKS

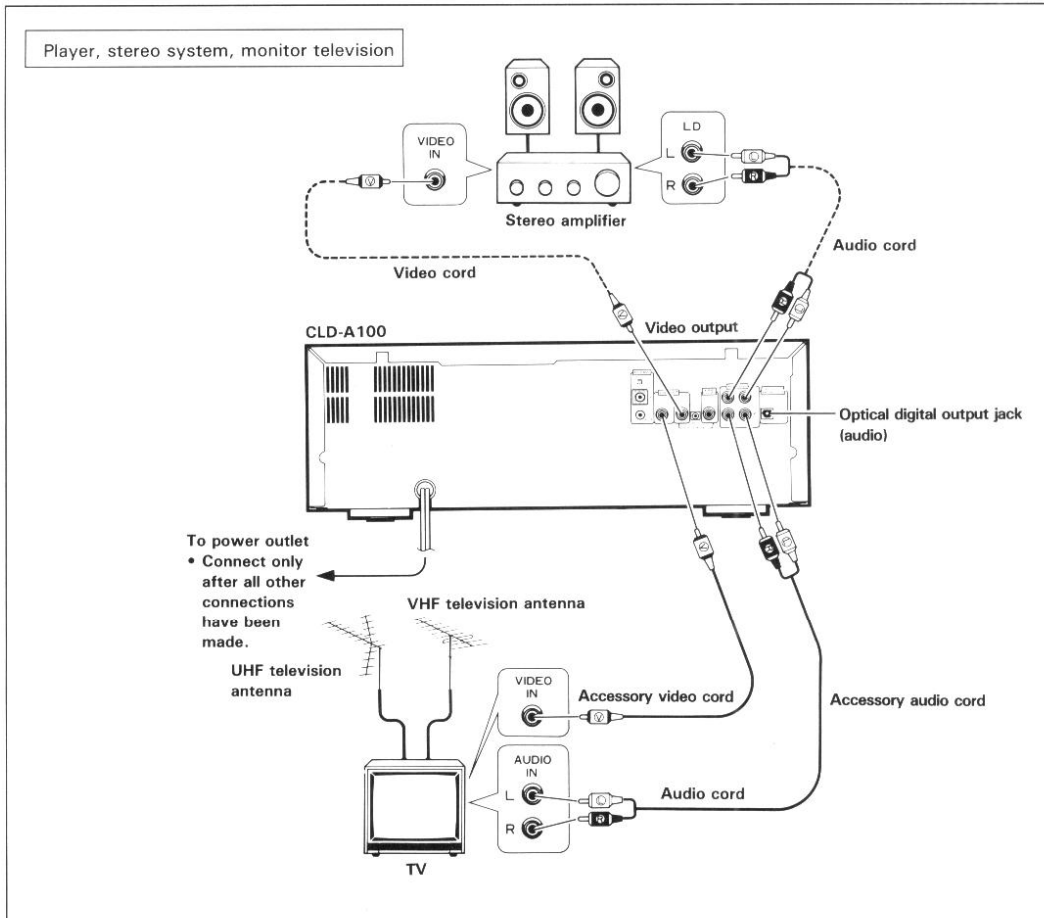

- Connect the VIDEO OUT jack of the player to the video input jack of the monitor television.
- Connect the AUDIO OUT jacks to the stereo amplifier AUX, CD, LD, VDP or other jacks, except the PHONO input jacks. The television speakers can also be used by connecting the television audio input jacks and the player AUDIO OUT jacks. However connection to a stereo amplifier is recommended to obtain superior audio playback quality for Compact Discs and LaserDiscs. Do not change the television antenna and VCR connections.
- Connect the power cord to an AC wall outlet.
- Combined system control is possible when a Pioneer television and audio/video stereo receiver are connected. Refer to page 14 and 15 for an explanation of the connection procedure.

## CONNECTIONS

### USING TELEVISION WITHOUT AUDIO AND VIDEO JACKS (WITH OPTIONAL RF MODULATOR JA-RF3L)

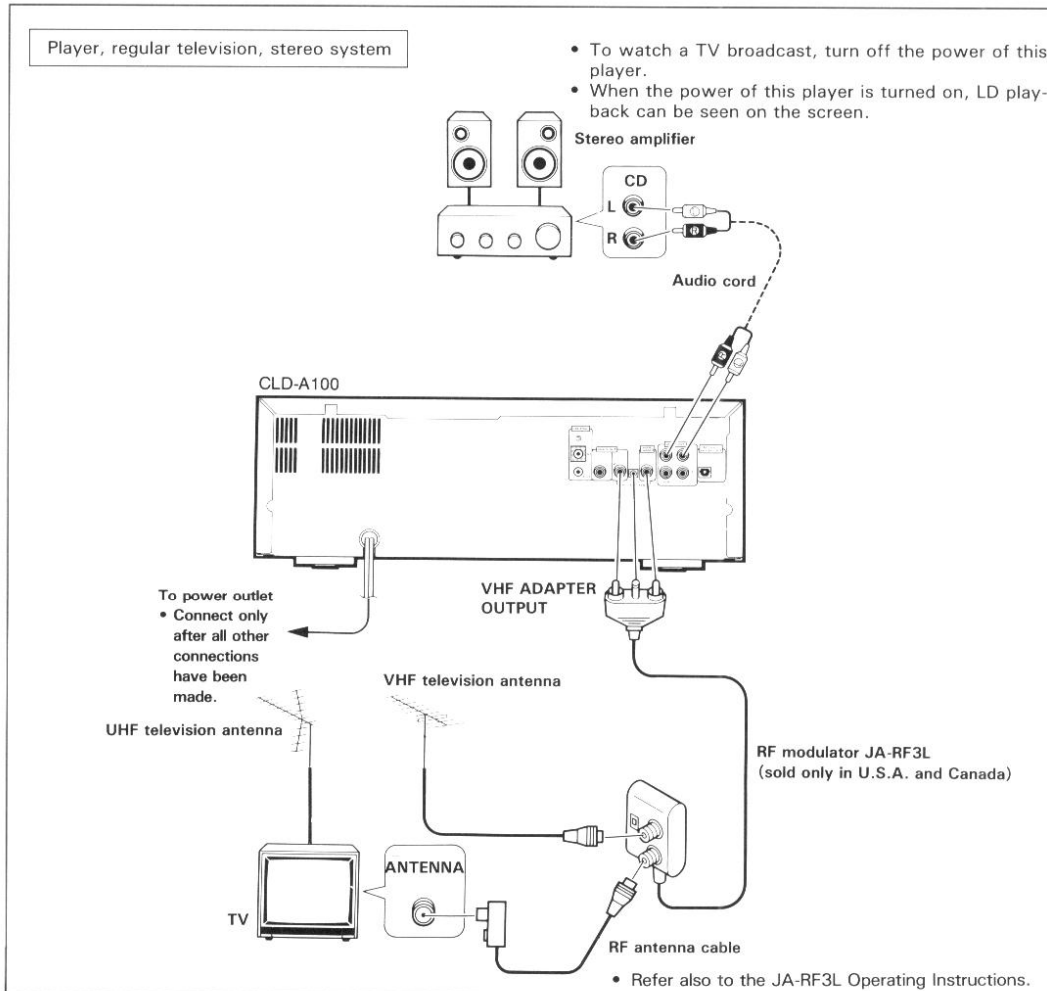

1. Detach the VHF antenna cable from the VHF antenna terminal of your TV set, and connect the cable to the VHF IN terminal of the RF modulator JA-RF3L.
2. Connect the VHF OUT terminal of the RF modulator to the VHF antenna terminal of your TV set.
3. Connect the socket (3-pin) of the RF modulator to the VHF ADAPTER OUTPUT jacks.

When the sound from a LaserDisc or Compact Disc is output from a television speaker it becomes monaural sound. (This is the same as stereo television).

**NOTE:**

- Push the plug in firmly. If the plug is not properly inserted, it may result in snow or noise on the screen.

**Stereo amplifier connections**

Connect the AUDIO OUT jacks of the player to the AUX, CD or LD input jacks of your stereo amplifier.

**NOTE:**  
Do not connect these terminals to your amplifier PHONO input jacks.

**Connecting to the optical digital jack**

This unit can be connected to an amplifier equipped with an optical digital jack.

**NOTE:**  
The optical fiber cable is not supplied with this unit. Use a separately sold optical fiber cable for the digital jack connections.

**■ When using the OPTICAL DIGITAL OUT jack:**

1. Remove the protective dust cap from this unit's OPTICAL DIGITAL OUT jack.
2. Use an optical fiber cable to connect OPTICAL DIGITAL OUT jack of this unit to the optical digital input jack of the amplifier.
- Align the plug of the optical fiber cable with the optical digital jack and fully insert the plug to make a secure connection.

**NOTES:**

- When making optical digital connections, this player can only be connected to an amplifier which uses the same type of optical transmission/reception module.
- Fully insert the optical fiber cable plugs all the way into the jacks.
- Be careful not to fold or crimp the cable. When coiling an optical fiber cable for storage, make sure the diameter of the coil is 15 cm (6 inches) or larger.
- Use an optical fiber cable with a length of 3 m (10 feet) or less.
- Protect the optical fiber cable plugs from scratches and dust.
- When the unit is not connected using an optical fiber cable, be sure to keep the protective dust cap plugged into the optical digital output jack at all time.

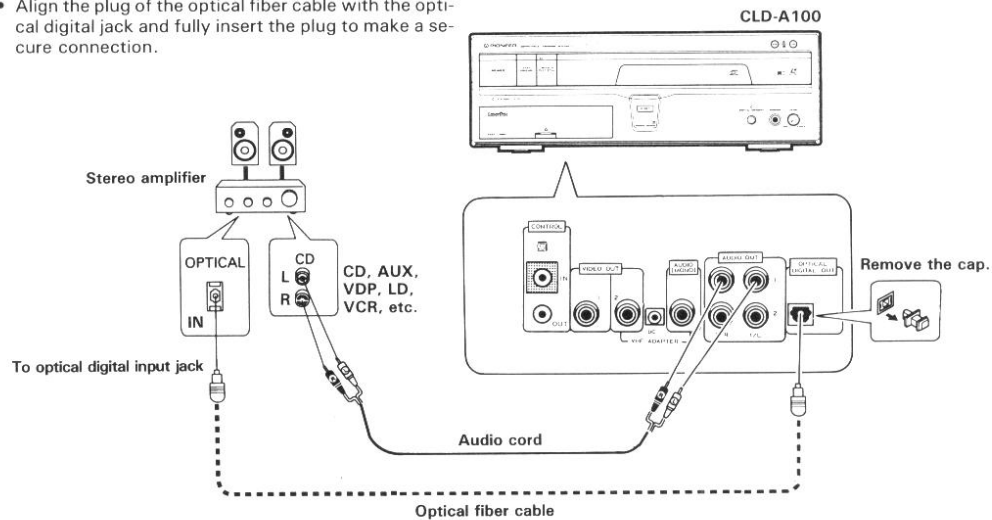

**Plug the AC power cords of the player, stereo amplifier and TV set into an AC outlet.**

When the power cord of this unit is connected to an AC outlet, power is supplied to the unit's internal memory (such as the last memory) even when the POWER button on the remote control unit is OFF. Therefore, be sure to connect the power cord directly to a wall outlet. If the power cord is connected to an outlet such as a switched outlet on an amplifier, the various memory contents will be erased whenever the amplifier's power switch is turned off.

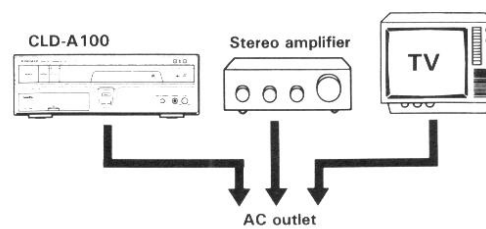

## CONNECTIONS

### SYSTEM REMOTE CONTROL CONNECTION

#### WHEN COMBINED WITH OPTIONAL PIONEER PROJECTION MONITOR (or COMPONENT DISPLAY)

Connect the VIDEO OUT jack of the player to the video input jack of the projection monitor (or component display), and connect the AUDIO OUT jacks of the player to the audio input jacks of the projection monitor (or component display).

#### System Control

By connecting the CONTROL IN jack of the player to the remote jack of the projection monitor (or component display), the system can be controlled by the remote control unit of the player at the remote control sensor of the projection monitor (or component display).

- Use a commercially available cord with mini-plugs for the connection.

Please also refer to the operating instructions for the projection monitor (or component display).

#### NOTE:

When system control connections have been made, the player cannot be directly controlled by the remote control unit. To operate the player, aim the remote control unit at the projection monitor (or component display).

#### WARNING!

Still pictures or images, such as those generated by videogames, can cause permanent damage to projection TV's.

We recommend that this product not be used with a large-screen projection TV.

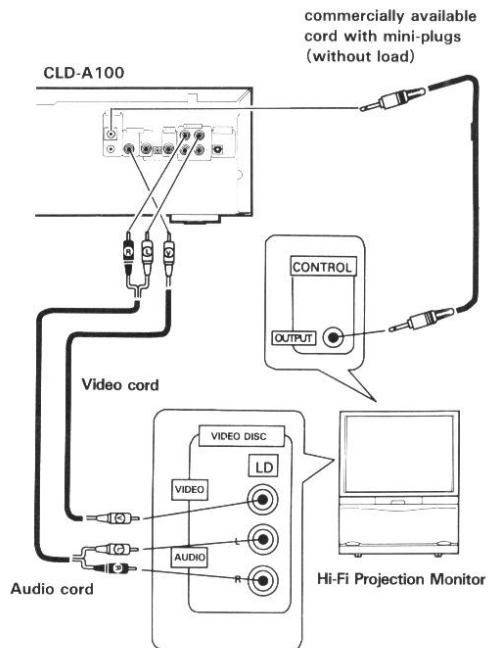

**PERFORMING SYSTEM CONTROL WHEN THE PLAYER IS COMBINED WITH A PRODUCT THAT HAS THE  MARK**

System control can be performed when the player is combined with an optional AV amplifier, which can provide centralized control of Pioneer products with the  mark.

Connect the VIDEO OUT jack of the player to the video disc video input jack of the AV amplifier and connect the AUDIO OUT jacks of the player to the audio input jacks of the AV amplifier.

Connect the CONTROL OUT jack of the AV amplifier to the CONTROL IN jack of the player using a commercially available cord with mini-plugs.

- For details concerning the connection and operation methods, please refer to the operating instructions for the AV amplifier.

**NOTE:**

*When a connecting cord has been connected to the CONTROL IN jack, direct control of the player with the remote control unit is not possible. Operate the player with the remote control unit by aiming it at the AV amplifier.*

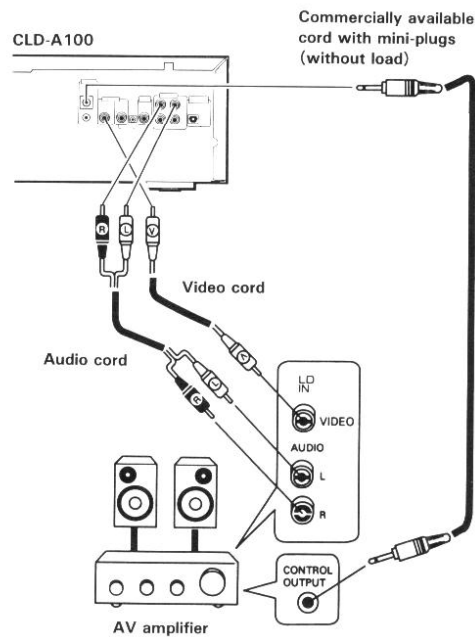

## NAMES AND FUNCTIONS OF FRONT PANEL COMPONENTS

The numbers refer to the page numbers where the components are explained in more detail.

### POWER SWITCH ... p. 22

Press to switch the power supply ON/OFF. When installing/detaching the Control Pack, ensure that the power supply is OFF.

### PLAY/STILL BUTTON ... p. 23

Press to perform playback of the disc. Press during performing playback of an LD or CDV disc, and the picture becomes still.

### STANDBY/ON INDICATOR

Illuminates green when the power supply is switched ON by the power switch. When the power supply is switched OFF by the remote control unit, the indicator lights up red.

### DISC TABLE ... p. 23

### RESET BUTTON

Resets the games software when playing games software utilized by the separately sold Control Pack.

### Control Pack installation slot

### Control Pack installation slot cover

Attach when the Control Pack is not installed.

### PACK RELEASE BUTTON

Press to release the Control Pack.

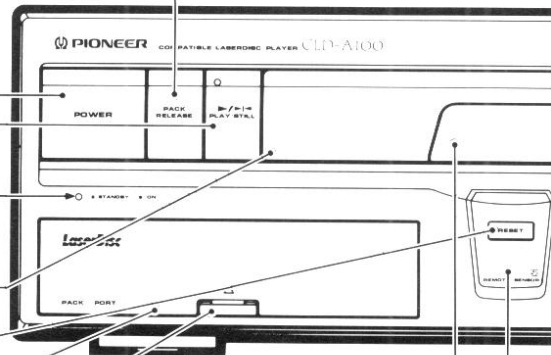

### CD DISC TABLE

Exclusive use CD disc table

### REMOTE CONTROL SENSOR

### INSTALLING THE CONTROL PACK

**1. Switch OFF** the power supply to the main unit.

**2. Remove the Control Pack installation slot cover.**

While lifting up the center of the cover with a finger nail, pull forward and detach.

**3. Insert the Control Pack into the interior of the main appliance.**

To install accurately, lightly hold the main appliance by the top surface and carefully insert the Control Pack until the front panel is flush with the front panel of the player.

#### NOTES:

- Carefully put the detached Control Pack installation cover somewhere for safekeeping, as it will be required when the Control Pack is removed from the main appliance.
- When the black lever protrudes in the top center of the Control Pack insertion slot and the Control Pack cannot be inserted, press in the RELEASE button.

1

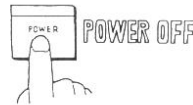

2



3

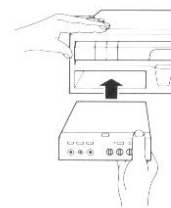

### DETACHING THE CONTROL PACK

**1. Switch OFF** the power supply to the main unit.

**2. To detach the Control Pack accurately, lightly hold the main appliance by the top surface and press the RELEASE button.**

The Control Pack is partially ejected forward.

**3. Detach the Control Pack.**

**4. Fit the Control Pack insertion slot cover.**

First, introduce the top edge of the cover into the cover attachment slots on the main appliance, then fit the bottom edge into place.

1

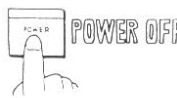

2



3





## NAMES AND FUNCTIONS OF FRONT PANEL COMPONENTS

**CD STOP OPEN/CLOSE BUTTON** (  ) ... p. 22  
Stops disc playback and open/closes the CD disc table

**LD STOP OPEN/CLOSE BUTTON** (  ) ... p. 22  
Stops disc playback and open/closes the LD disc table

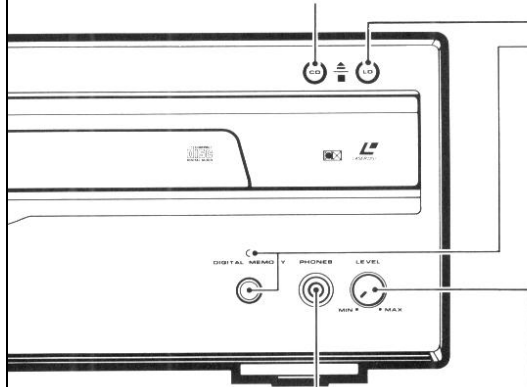

**HEADPHONES TERMINAL (PHONES)**  
Insert standard type headphones.

**HEADPHONES VOLUME ADJUSTMENT KNOB (LEVEL)**

### DIGITAL MEMORY button/indicator :

When playing a CAV or CLV disc, turning the digital memory function ON allows you to enjoy special playback functions such as still frame and multi-speed playback with no screen disturbance. If the digital memory function is OFF, it will automatically turn ON when you fast-forward, fast-reverse or activate a special playback function (except with CAV discs). When digital memory is OFF, screen disturbance may occur momentarily when an operation such as fast-forward is carried out. However, horizontal resolution is better than when digital memory is ON.

### NOTES:

- When using a special function obtained by connecting a commercially available adaptor (such as a caption adaptor), be sure to turn the digital memory function OFF. The adaptor will not function properly if digital memory is left ON.
- Screen disturbance may occur momentarily when an operation such as fast-forward, fast-reverse or a special playback function is carried out when digital memory is OFF. This is not a malfunction or disc defect.
- This player memorizes the ON/OFF condition of the digital memory function even if the power is turned off. Turn the digital memory function ON or OFF as required the next time you play a disc. The "DIGITAL MEMORY" indicator lights when digital memory is ON.

## NAMES AND FUNCTIONS OF REMOTE CONTROL UNIT COMPONENTS

A detailed description is provided on the indicated page (s).

Remote control buttons with the same names or marks as buttons on the front panel of the player control the same operations as the corresponding front panel buttons.

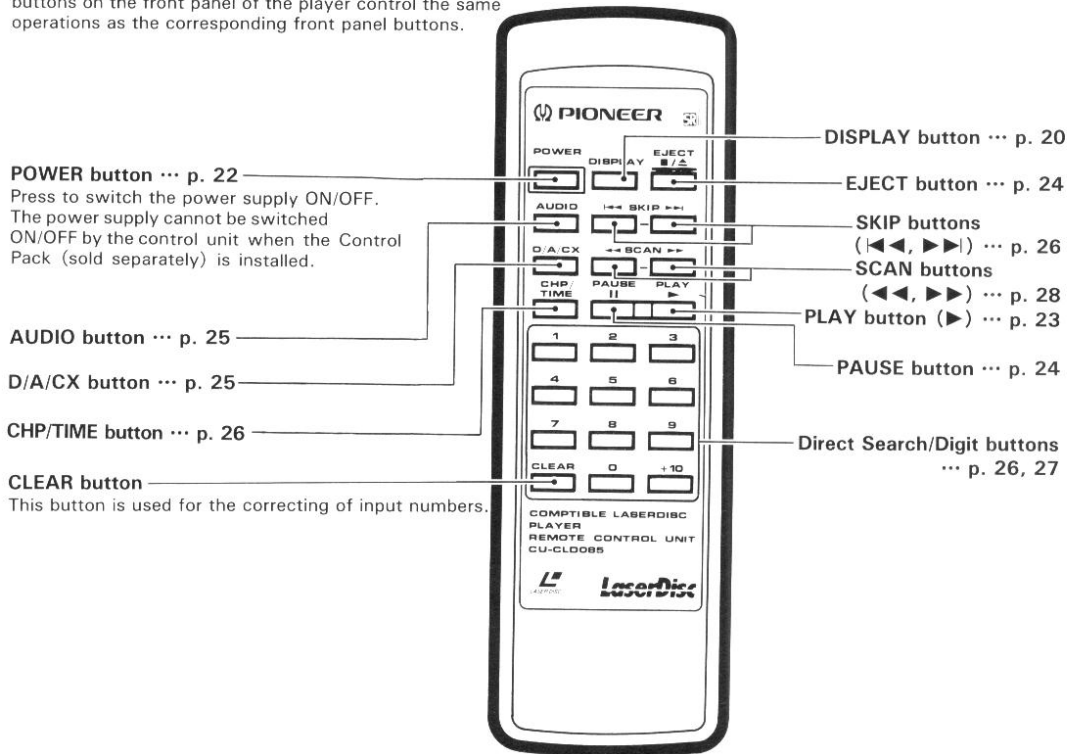

When operating the remote control unit, point the unit's infrared signal transmitter at the remote control receiver on the front panel of the player. The remote control unit can be used within a range of about 7 meters (23 feet) from the remote sensor, and within angles of up to about 30 degrees.

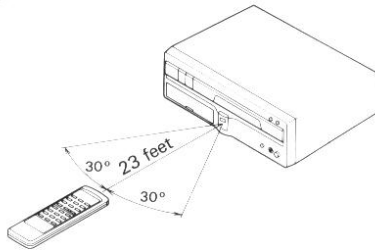

### NOTES FOR USING THE REMOTE CONTROL UNIT

- If a plug is connected to the CONTROL IN terminal at the rear of the player, remote control operations cannot be done with the remote control unit aimed at the player's remote control sensor. Aim the remote control unit at the AV amplifier or the component display's sensor instead.

- If there is any obstacle between the remote control unit and the player, or if the unit is held at too large an angle relative to the front panel of the player, the signal from the remote control unit will fail to reach the remote sensor.
- If the player is operating in the vicinity of other appliances generating infrared rays, or if other remote control devices using infrared rays are used near the player, the player may operate improperly. Conversely, if the player's remote control unit is operated in the vicinity of other appliances which use an infrared remote control device, the other appliance may operate improperly. If this should happen, change the place of installation so that improper operation does not occur.
- If the range of operation of the remote control unit becomes too short, replace the batteries.
- When the unit is not to be used for a long period of time (more than one month), remove the batteries to prevent them from leaking inside the compartment. If leakage occurs, wipe up the liquid inside the compartment and replace the batteries with new ones.
- Do not place books or other objects on the remote control unit, since they might depress the buttons and run down the batteries.
- If the remote control sensor window is in a position where it receives strong light such as sunlight or fluorescent light, control may not be possible.

## NAMES AND FUNCTIONS OF THE REAR PANEL COMPONENTS

### VIDEO OUTPUT 1, 2 TERMINALS (PIN-JACK)

Connect to the video input terminal of the TV or AV amplifier. Video output terminals 1 & 2, implies that the terminal has two networks.

### CONTROL INPUT/OUTPUT TERMINAL (MINI-JACK)

Terminal for connecting a control cord for when controlling a compatible system that bears the pioneer  mark.

### AUDIO OUTPUT 1, 2 TERMINALS (PIN-JACK)

Connect to the input terminal of the TV VDP (LD) or stereo amplifier VDP (LD), CD etc.. Do not connect to the PHONO terminal. Audio output terminals 1 & 2, are the same as those for the video output mentioned on the left.

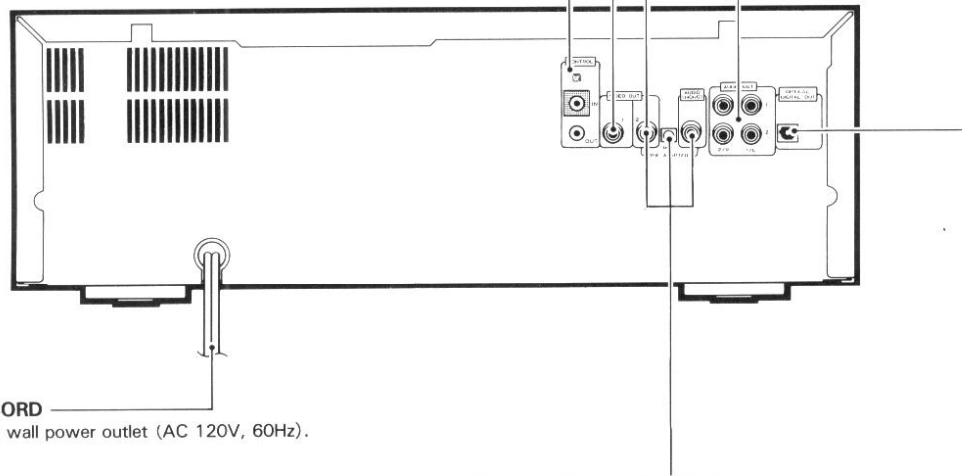

**POWER CORD**  
Connect to wall power outlet (AC 120V, 60Hz).

### VHF ADAPTER TERMINAL

By utilizing a separately sold RF modulator (model No. JA-RF3L), hook-up to a normal television is made possible. However, even though the TV may be stereo, the TV sound will be mono. By using this terminal, the TV output becomes a single network.

### OPTICAL DIGITAL OUTPUT TERMINAL

In the case where the stereo amplifier has an optical terminal, connect to this terminal. By performing digital sound playback of CDs, CDVs and LDs with digital sound, the digital audio signal is output optically.

## DISPLAY SWITCHING

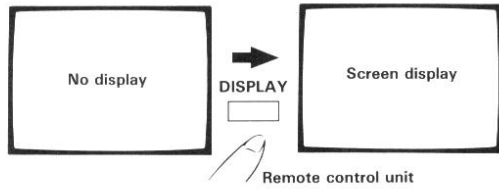

Information regarding the operations being carried out can be displayed on the screen of the monitor TV. When DISPLAY on the remote control unit is pressed the first time, the screen display appears.

### With LD discs containing a TOC ...

Each time DISPLAY is pressed, the display changes in the following order: time/frame number (elapsed play time/frame from the beginning of the disc) → Remain Time ALL (remaining play time of the disc) → Total Time (total play time of the disc) → display off.

- With CAV discs, the Disc time ABS (elapsed play time from the beginning of the disc) is displayed after the frame number.

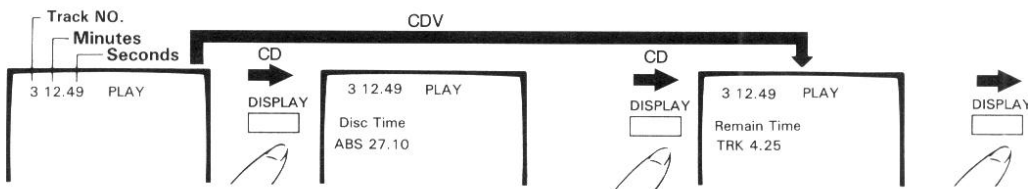
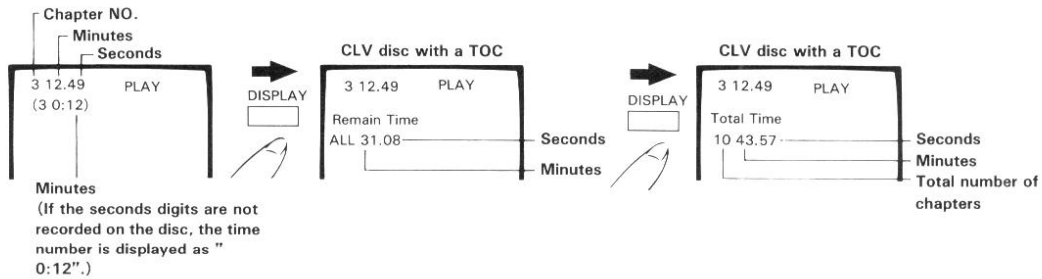

### Other displays

Lights-Flashes	Function	Lights-Flashes	Function
OPEN	Opening of the table	1/Lch	Main audio/Left channel
CLOSE	Closing of the table	2/Rch	Sub audio/Right channel
STOP	Stop mode	CX ON	CX noise reduction system ON
PLAY	Play mode	CX OFF	CX noise reduction system OFF
PAUSE	Pause mode	Last Memory	Last memory
STILL	Frozen picture	Need control pack	Attempting to Perform Playback with Non-compatible Disc:
Video	Video part search	PSC ON	Picture stop cancel
Audio	Audio Part search	PSC OFF	Picture stop
Digital	Digital signal setting		
Analog	Analog signal setting		
Stereo	Stereo		

## DISPLAY SWITCHING

### With LD discs not containing a TOC ...

Each time DISPLAY is pressed, the display changes in the following order: time/frame number → display off.

### With CDV discs ...

Each time DISPLAY is pressed, the display changes in the following order: elapsed play time of the track being played → Remain Time TRK (remaining play time of the track being played) → Remain Time ALL (remaining play time of the video or audio part being played) → Total Time (total play time from the beginning of the video or audio part being played) → display off.

### With CD discs ...

Each time DISPLAY is pressed, the display changes in the following order: elapsed play time of the track being played → Disc Time ABS (elapsed play time from the beginning of the disc) → Remain Time TRK (remaining play time of the track being played) → Remain Time ALL (remaining play time of the disc) → Total Time (total play time from the beginning of the disc) → display off.

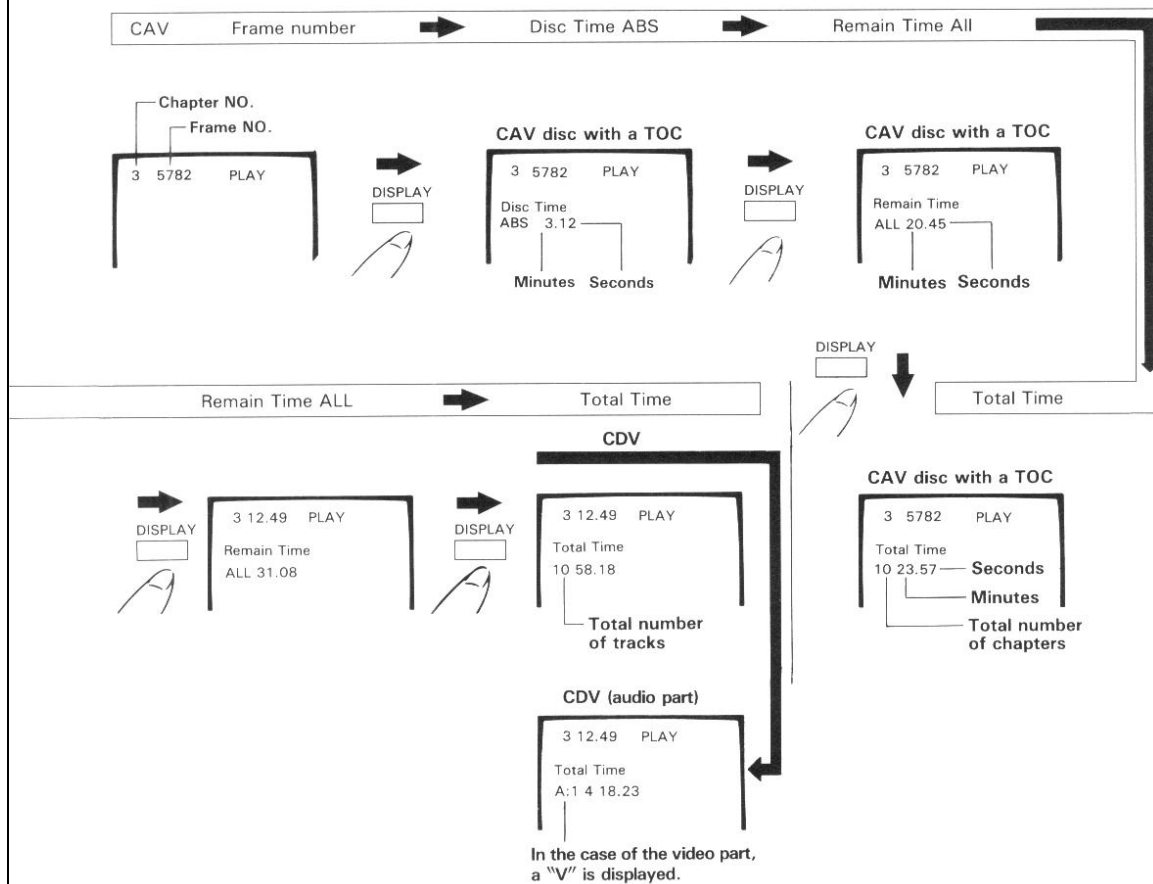

**TO PLAY AN LD, CDV OR CD**

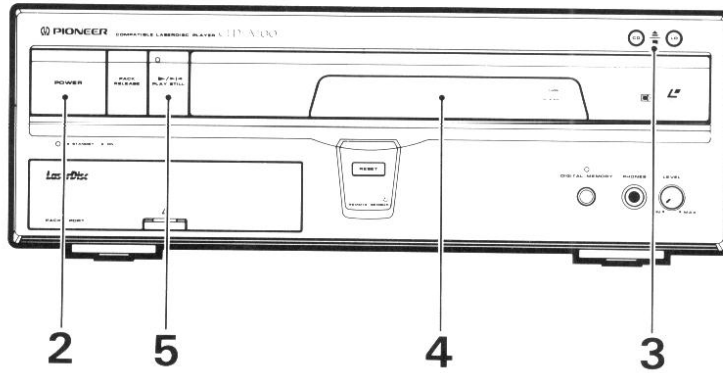

**1**  
 Turn on the power to the monitor TV and/or audio system.

**When a stereo system is used for audio listening:**  
 Turn on the power of the amplifier, and set its input selector to the proper position for listening to the player, such as "LD".

**2**  
 Turn on the power to this unit.

**3**  
 Open the disc table.

Only the LD tray does not eject when operated by the remote control unit.

**REMOTE CONTROL UNIT POWER BUTTON**  
 The remote control unit power button can be used to switch the power supply to the main appliance ON/OFF, after the power switch on the front panel is switched ON. When the standby indicator illuminates green, the power supply can be switched OFF, and when the indicator illuminates red, the power supply can be switched ON. That is to say, when the power switch on the front panel of the main appliance is OFF, the remote control unit does not operate. This also applies when a separately sold Control Pack is installed.

**When the CD STOP OPEN/CLOSE button is pressed :**  
 If there is no LD in the disc table, only the CD disc table is ejected.

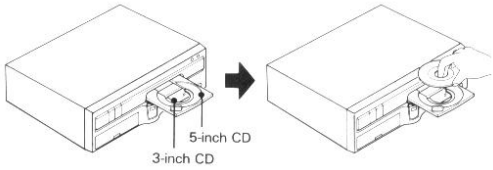

## TO PLAY AN LD, CDV OR CD

Front panel buttons and remote control unit buttons with the same name or mark have the same function.

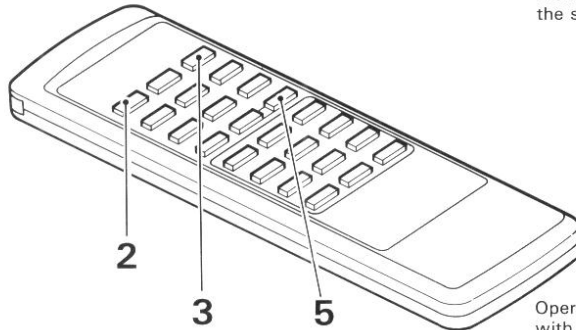

Operations indicated by the [  ] mark are performed with the remote control unit.

## 4

**Load a disc**

As shown in the following diagram, place the disc on the disc table in the groove corresponding to the size of the disc. If the disc is not centered correctly on the disc table, the disc will not be played or the disc or the player may be damaged. Always place the disc correctly according to the required disc size on the disc table.

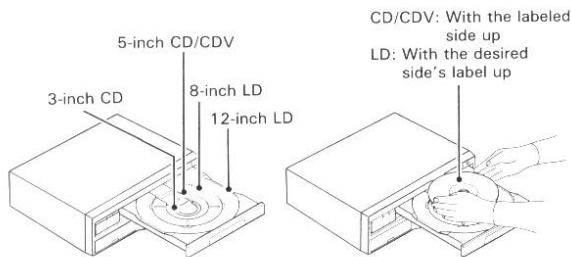

## 5

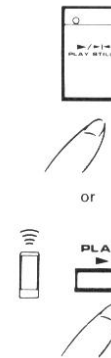
**Start playback.**

- With CDV discs, the video part is played first.

**To avoid malfunctions, be especially careful about the following points.**

- Do not place any object other than a disc on the disc table.
- Do not move the player while a disc is playing. This will cause the disc to be scratched.

**Precautions concerning disc loading**

- Do not place more than one disc on the disc table. If two discs are placed one on top of the other on the disc table, discs may be scratched and/or malfunction may occur.
- With this unit, playback of all types of discs is carried out without the use of adaptors. Therefore, do not use any type of adaptor with this unit.
- With CDs, CDV discs, and single-sided LDs, always be sure to load discs with the label side facing upward.

**Last Memory function:**

If the power is turned off by remote control during LD playback, a playback position slightly ahead of the current frame is stored in the unit's memory (Last Memory). When the power is turned back on by the remote control and playback is started from the memorized position by pressing ►, "Last Memory" is displayed.

**To play and listen to a disc without connecting this unit to an audio system:**

Plug headphones into the PHONES jack on the front panel of this unit and adjust the volume with LEVEL control.

**When Attempting to Perform Playback with a Non-compatible Disc:**

In the main unit, when attempting to perform playback of a non-compatible disc (LD-ROM etc.), the "Need Control Pack" message is displayed in the bottom of the TV screen. This type of disc cannot be played back.

TO PLAY AN LD, CDV OR CD

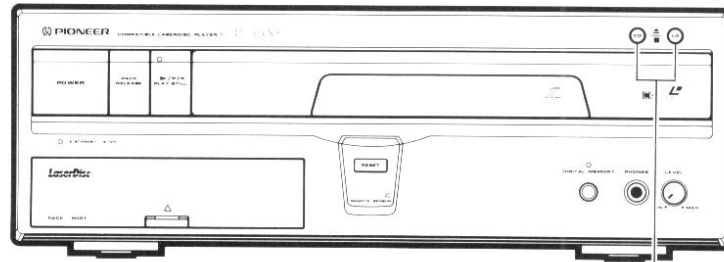

To pause playback temporarily



The sound and/or video image disappears. Press PAUSE **||** again to resume playback from the position where pause mode was entered.

- During playback of CD or CDV audio part, front panel **▶/▶▶** is also used to pause playback temporarily.



To stop playback



or



Once

When PLAY/STILL **▶/▶▶** is next pressed, disc playback starts again from the beginning.



To stop playback and take out the disc



or



Twice

After removing the disc from the disc table, press **▶** or PLAY/STILL **▶/▶▶** to close the table.

Discs marked with the **⊗** mark

Discs marked **⊗** are recorded with the CX noise reduction system for powerful audio reproduction with little noise. (Analog audio only) However, some discs marked are not encoded with the signals necessary to instruct the unit to automatically switch on the CX system. If sound is noisy or undulates when a disc with a **⊗** mark is played, press D/A/CX on the remote control unit.

- **⊗** is a trademark of CBS Inc. This player meets the CX EXPANDING SPECIFICATION.

**NOTE:**

Even when the player is in the pause mode, the disc motor is still revolving. Since leaving the player in this condition can shorten the lifetime of the motor, do not leave the player in the pause mode for long periods of time.

To watch a TV broadcast:

- Switch to the broadcast using the controls of your TV.
- When using a normal TV set and RF modulator JA-RF3L (sold separately), press the unit's power switch and the power will be turn off.

For canceling the picture stop function in LDs with recorded picture stop codes, use the "Picture Stop Cancel Function":

By pressing the PLAY/STILL **▶/▶▶** button for approx. 3 sec., "PSC ON" displays on the screen. At the point where the stop code is recorded without stopping, the viewing can be continued. One more time, press the PLAY/STILL **▶/▶▶** button for more than 3 sec., and "PSC OFF" displays on the screen. When a picture stop code is encountered, the screen becomes still.



## TO PLAY AN LD, CDV OR CD

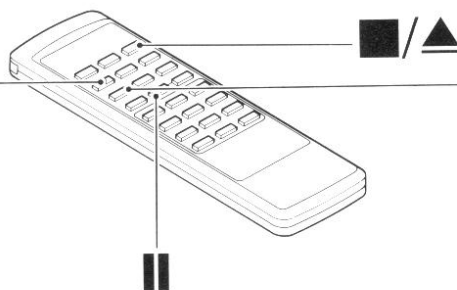

## AUDIO

To listen to only one channel of a stereo disc, or to select the audio on a sound multiplex disc

During playback

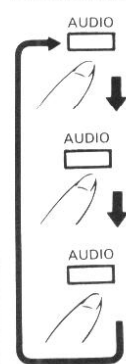

Played audio		Display on screen
Stereo disc	Sound multiplex disc	screen
Stereo	Audio 1/L (Left) Audio 2/R (Right)	
Left	Audio 1/L (Left) <Karaoke>	1/L ch
Right	Audio 2/R (Right) <vocal>	2/R ch
	Return to start	Stereo

## D/A/CX

To listen to the analog audio of an LD digital audio disc:

During playback

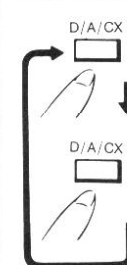

Played audio	Display on screen
Digital	Digital
Analog	Analog
Return to start	

With a Multi Audio disc (an LD bearing the *digital sound* mark and the **MULTI AUDIO** mark or the *digital sound* **MULTI AUDIO** mark), you can listen to the various audio tracks recorded on the disc by using D/A/CX to select between the analog and digital audio tracks, and by using AUDIO to select between the left (1/L) and right (2/R) channels.

**Examples of the various types of audio recorded on Multi Audio discs**

Disc	Audio	Analog audio	Digital audio
Movies, animations, etc.		Audio of the main program	Soundtrack
Dual music		Music 1	Music 2
Various types of digital audio karaoke		1/L Karaoke (monaural) 2/R Assisting vocals	Stereo Karaoke
Stereo bilingual		Native language	Foreign language 1

Disc	Audio	Analog audio	Digital audio
Trilingual		Native language	1/L Foreign language 1 2/R Foreign language 2
Quadrilingual		1/L Native language 2/R Foreign language 1	1/L Foreign language 2 2/R Foreign language 3

## TO SEARCH FOR A PARTICULAR CHAPTER/TRACK

### Chapter (Track) Search/Chapter (Track) Skip

The term "chapter" refers to each section on an LD, and the term "track" refers to each section on a CD or CDV disc.

If chapter or track numbers are encoded on a disc, it is so indicated on the disc jacket

- Chapter Search is not possible with discs which are not divided into chapters.

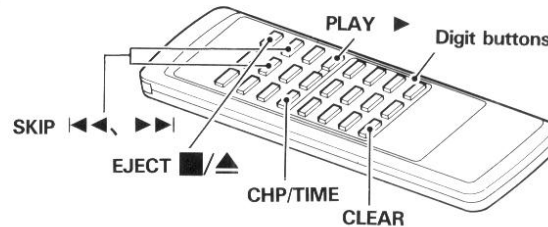

### Chapter (Track) Search – To search by designating the chapter/track number

#### Example:

To play from the beginning of Chapter/Track 3:

#### <Direct Search>

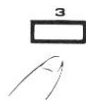

Enter 3 with the digit button.

#### <Normal Search>

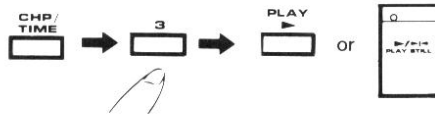

When the display shows Frame No. or Time No. press this button again.

Enter 3 with the digit button.

#### To search for chapter or track number 10 or above:

Use [+10] button.

(Example) To enter 17: [+10], [7]

To enter 30: [+10], [+10], [+10], [0]

#### If you make a mistake in pressing the digit buttons during normal search operation:

Press CLEAR, and then press the correct button.

#### To identify the present chapter number and frame (or time) number:

The information can be displayed on the monitor TV screen by pressing DISPLAY on the remote control unit.

#### Notes on LDs

If PLAY ► on the remote control unit is pressed, the beginning of the designated chapter is played with still frame.

If ►► on the front panel is pressed, Normal playback starts from the beginning of the designated chapter.

### Chapter (Track) Skip – To search for the beginning of a chapter/track



Press once to return the playback position to the beginning of the chapter/track being played. If the button is pressed more than once before the picture reappears, the beginning of a chapter/track located before the chapter/track being played is searched for and played. The position of the located track corresponds to the number of times the button is pressed.

If this button is pressed once or a number of times, playback is advanced to the beginning of a chapter/track located after the chapter/track being played. The position of the located track corresponds to the number of times the button is pressed.

## TO SEARCH FOR A PARTICULAR TIME/FRAME

Time Number Search/Track time Search/ABS Time Search/Frame Number Search

**Time Number Search – Example: To search for the scene located at time number 12 min. 34 sec (CLV)**

**1. Press CHP/TIME**

When the display shows chapter NO., press this button again.

**2. Enter **1**, **2**, **3** and **4** with the digit buttons.**

If you make a mistake during entry:

Press CLEAR to reset the time number to "0.00", and then press the correct digit buttons.

**3. Press PLAY ►.**

**CAUTION**

- If a disc does not contain information on the digits of seconds, specify the time number only as far as the minute digits.

**Track Time Search – To search for a time on a specified track (CD/CDV)**

**1. Press CHP/TIME.**

**2. Press SKIP ◀◀ or ▶▶.**

**3. Enter the track time (elapsed time from the beginning of the specified track) with the digit buttons (0 – 9).**

**4. Press PLAY ►.**

**ABS Time Search (CD only) – To search for a point by designating the elapsed time from the beginning of the disc**

**1. Press CHP/TIME so that "ABS" appears on the screen.**

**2. Enter the elapsed time from the beginning of the disc with the digit buttons (0–9).**

**3. press PLAY ►.**

Playback starts from the specified elapsed time.

**Frame Number Search (CAV discs only) – To search by designating the frame number**

Any desired frame can be searched for by specifying its frame number.

**1. Press CHP/TIME. When the display shows chapter No., press this button again. "Frame 0" is displayed.**

**2. Enter the required frame number with the digit buttons (0 – 9).**

**3. Press PLAY ►.**

**NOTES:**

- The +10 button does not function.
- If you make a mistake during entry, press CLEAR and press the correct digit buttons.

**To exit search mode:**

Press CLEAR.

**When PLAY ► on the remote control unit is pressed:**

A still frame is displayed (LD or video part of CDV). To start normal playback, press PLAY ►. During PLAY/STILL ►/▶▶, when a frame search is started from still frame mode or pause mode, the unit will return to pre-search conditions.

## TO SEARCH FOR A PARTICULAR PASSAGE

### Manual Search

#### Manual Search – Search using fast forward or fast reverse



For about two seconds after the button is pressed, Low Scan is performed, after that, the unit enters High Scan.

**Low Scan mode** : Scan speed becomes about x10 the normal playback speed.

**High Scan mode** : Scan speed becomes about x30 the normal playback speed.

- With video part of CDV, High Scan mode cannot be carried out.

**If scanning is continued until the start of the disc:**

Normal playback will start.

**If scanning is continued until the end of the disc:**

A still frame will appear at the end of the LD.

If scanning is continued to the end of the video part of the CDV, search of the audio part will occur and playback will start from Track 1.

With the CD, pause conditions will result.

- With CDs or audio part of CDVs, sound is heard at low volume level while scanning.
- Others: Sound is muted.

**Notes on CAV:**



*While scanning, noise may occur on the screen. This is not a malfunction.*

**Notes on CLV:**

- *While scanning, the color of the image may fade out or the image sometimes fluctuates.*
- *The scan speed is different between inner tracks and outer tracks.*

## TROUBLESHOOTING



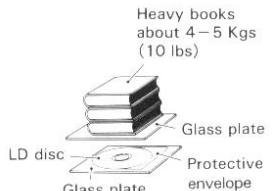



Incorrect operations are often for trouble and malfunctions. If you think that there is something wrong with this component, check the points below. Sometimes the trouble may lie in another component. Inspect the other components and electrical appliances being used. If the trouble cannot be rectified even after exercising the checks listed below, ask your nearest PIONEER authorized service center or your dealer to carry out repair work.

SYMPTOM	CAUSE	REMEDY
1. Disc table is not ejected when OPEN/CLOSE is pressed.	<ul style="list-style-type: none"> <li>Power cord is not properly plugged into AC wall socket.</li> <li>Power switch is not turned on.</li> </ul>	<ul style="list-style-type: none"> <li>Plug in power cord.</li> <li>Turn on power switch.</li> </ul>
2. Even if playback is attempted, "Need Control Pack" will be displayed and the unit will not playback.	<ul style="list-style-type: none"> <li>Playback of a LaserActive-compatible LD-ROM disc (discs bearing a  mark or a  mark) is being attempted, but the Control Pack [PAC-N10 or PAC-S10 (sold separately)] is not installed.</li> </ul>	<ul style="list-style-type: none"> <li>Install a Control Pack [PAC-N10 or PAC-S10 (sold separately)].</li> <li>Change to a disc other than a LaserActive-compatible LD-ROM disc.</li> </ul>
3. Disc table comes out.	<ul style="list-style-type: none"> <li>Disc is dirty.</li> <li>The disc is not properly set on the disc table.</li> <li>Moisture has condensed on parts in the player.</li> <li>Disc is warped.</li> </ul>	<ul style="list-style-type: none"> <li>Clean disc.</li> <li>Set the disc properly.</li> <li>Remove disc and let player stand for 1 to 2 hours until it is dry.</li> <li>Try to alleviate the warp. (Refer to Symptom 9, remedy column.)</li> </ul>
4. TV broadcast is not projected to screen. (When using RF modulator JA-RF3L) <span style="border: 1px solid black; padding: 2px;">UHF broadcasts do not project</span>	<ul style="list-style-type: none"> <li>VHF antenna is not connected to the adaptor.</li> <li>The power supply to the player is not switched ON.</li> <li>The VHF and UHF cables are cross-connected to the adaptor.</li> </ul>	<ul style="list-style-type: none"> <li>Connect the VHF antenna to the antenna terminal of the adaptor, and the VHF output terminal to the TV.</li> <li>Switch the power supply OFF.</li> <li>Separate the VHF and the UHF. Connect the VHF to the adaptor and the UHF to the TV.</li> </ul>
5. Remote control does not work.	<ul style="list-style-type: none"> <li>The CONTROL IN terminal on the rear panel is connected to pioneer projection monitor or AV control center.</li> <li>Batteries are weak.</li> <li>There is an obstacle between the player and the remote control unit.</li> <li>Remote control unit is not in a good location for transmission.</li> </ul>	<ul style="list-style-type: none"> <li>Aim the remote control unit at the projection monitor or AV control center.</li> <li>Replace batteries.</li> <li>Remove the obstacle or shift the remote control position.</li> <li>Operate the remote control unit in front of the player.</li> </ul>
6. Operation of the remote control unit causes the TV to operate improperly.	<ul style="list-style-type: none"> <li>Some TV sets have remote control functions that operate improperly in response to the remote control unit of the player.</li> </ul>	<ul style="list-style-type: none"> <li>Move the TV and the player further apart, or cover the remote sensor of the TV during disc playback.</li> </ul>
7. Disc is rotating but there is no picture.	<ul style="list-style-type: none"> <li>The TV set is not turned on.</li> <li>Wrong connections from player to TV.</li> </ul>	<ul style="list-style-type: none"> <li>Turn on TV.</li> <li>Make correct connections.</li> </ul>
8. Picture continuously moves vertically.	<ul style="list-style-type: none"> <li>The TV vertical hold control is not adjusted properly.</li> </ul>	<ul style="list-style-type: none"> <li>Adjust vertical-hold control on TV.</li> </ul>
9. Particular disc does not playback properly. The playback stops in the middle of the disc program.	<ul style="list-style-type: none"> <li>The playing surface of the disc is dirty.</li> <li>The disc is warped.</li> </ul>	<ul style="list-style-type: none"> <li>Use a soft cloth and lightly wipe off the dirt from the surface of the disc. If necessary, moisten a cloth with diluted neutral detergent to remove heavy dirt of fingerprints.</li> <li>LD discs only Put the disc into the protective envelope, then place it on a flat desk top. Subsequently, place a flat board e.g. glass plate on the disc, and load it with about 4 – 5 kgs (about 10 lbs). If it is left in this state for one day, sometimes the warp will alleviated.</li> </ul> <div style="text-align: center;">  <p>Heavy books about 4 – 5 Kgs (10 lbs)</p> <p>Glass plate</p> <p>LD disc</p> <p>Glass plate</p> <p>Protective envelope</p> </div>

Abnormal functioning of this unit may be caused by lightning, static electricity, or other external interference. To restore normal operation, turn the power off and then on again, or unplug the AC power cord and then plug it in again.

## TROUBLESHOOTING

### WHEN A LASERVISION DISC IS BEING PLAYED

SYMPTOM	CAUSE	REMEDY
10. Sound is unnatural or distorted.	<ul style="list-style-type: none"> <li>CX system is turned ON for disc which has no  mark.</li> </ul>	<ul style="list-style-type: none"> <li>Press D/A/CX to turn CX system OFF.</li> </ul>
11. No sound output during playback.	<ul style="list-style-type: none"> <li>MULTI-SPEED or STILL/STEP playback is being performed. Sound is output only during the normal play mode. The audio signals are not output during other playback modes.</li> </ul>	<ul style="list-style-type: none"> <li>Press PLAY  to set the player to normal play mode.</li> </ul>
12. During STILL playback, a part of the screen image shakes.	_____	<ul style="list-style-type: none"> <li>Even if the disc is a standard play disc, there may be some cases in which a fully still image cannot be obtained, but this does not mean that the player or the disc is defective.</li> </ul>
13. CHAPTER SKIP and CHAPTER NUMBER SEARCH cannot be performed.	<ul style="list-style-type: none"> <li>Disc in which no chapter numbers are recorded is loaded.</li> </ul>	<ul style="list-style-type: none"> <li>Press DISPLAY to check if chapter number is displayed.</li> </ul>
14. Certain discs take too long to search or are not searched.	<ul style="list-style-type: none"> <li>It takes time to read the recorded code, depending on the disc.</li> </ul>	<ul style="list-style-type: none"> <li>Press CLEAR and picture will appear. (At this point, a slightly different scene from that which has been searched for may appear.)</li> </ul>
15. Certain discs take too long to start or do not start.	<ul style="list-style-type: none"> <li>There are errors when the disc code is read (There is no damage to the unit).</li> </ul>	<ul style="list-style-type: none"> <li>Press /▲ and stop the playback. Press PLAY  and start the playback again. (Repeat this operation a few times.)</li> </ul>
16. Picture other than instructed is searched in TIME NUMBER SEARCH mode.	<ul style="list-style-type: none"> <li>Method of inputting numerals in the TIME NUMBER SEARCH mode differs, depending on whether time number is recorded on disc in hours and minutes or minutes and seconds, as shown below: [e.g.] 12-minute search</li> <li>Disc in which time number is recorded in hours and minutes</li> </ul> <div style="text-align: center;">  </div> <ul style="list-style-type: none"> <li>Disc in which time number is recorded in minutes and seconds</li> </ul> <div style="text-align: center;">  </div>	

## WHEN PLAYING BACK A COMPACT DISC

SYMPTOM	CAUSE	REMEDY
17. Player stops immediately after playback is started.	<ul style="list-style-type: none"> <li>• Disc is loaded upside down (CD, CDV, onesided LD discs).</li> <li>• The playing surface of the disc is dirty.</li> <li>• Disc is not properly set on the disc table.</li> </ul>	<ul style="list-style-type: none"> <li>• Load the disc correctly with the label side upward.</li> <li>• Use a soft cloth and lightly wipe off the dirt from the surface of the disc. If necessary, moisten a cloth with diluted neutral detergent to remove heavy dirt or fingerprints.</li> <li>• Set the disc properly.</li> </ul>
18. No sound output	<ul style="list-style-type: none"> <li>• The stereo amplifier is not correctly connected.</li> <li>• You are not operating the stereo amplifier correctly.</li> <li>• The connection terminals and/or the plugs of the connection cords are dirty.</li> <li>• The plugs of the connection cords are disconnected, or are not fully pushed in.</li> <li>• The player is in pause mode.</li> </ul>	<ul style="list-style-type: none"> <li>• Connect the amplifier correctly.</li> <li>• Refer to the operating instructions for the amplifier, and operate the amplifier correctly.</li> <li>• Clean the plugs and terminals and connect again.</li> <li>• Make sure that connections are made correctly.</li> <li>• Press PLAY ► and restore the player to play mode.</li> </ul>
19. Sound is distorted.	<ul style="list-style-type: none"> <li>• The audio output jacks are connected to the PHONO jacks.</li> <li>• The connection terminals and/or the plugs of the connection cords are dirty.</li> <li>• The plugs of the connection cords are not fully pushed in.</li> </ul>	<ul style="list-style-type: none"> <li>• Connect to the AUX, CD, VDP, LD or VCR jacks.</li> <li>• Clean the plugs and terminals and connect again.</li> <li>• Push the plug in firmly.</li> </ul>

# SPECIFICATIONS

## 1. General

System ..... Laser Vision Disc system and Compact Disc digital audio system  
 Laser ..... Semiconductor laser wavelength 780 nm  
 Power requirements ..... AC 120 V, 60 Hz  
 Power consumption ..... 47 W  
 Weight ..... 7.8 kg (17 lbs 3 oz)  
 Dimensions ..... 420 (W) x 390.5 (D) x 145 (H) mm  
 16-9/16 (W) x 15-3/8 (D) x 5-11/16 (H) in  
 Operating temperature ..... +5°C - +35°C  
 (41°F - 95°F)  
 Operating humidity ..... 5% - 85%  
 (There should be no condensation of moisture.)

## 2. Disc

### Laser Vision Discs

\*Maximum playing times  
 12-inch standard play disc ..... 1 hour/both sides  
 12-inch extended play disc ..... 2 hours/both sides  
 8-inch standard play disc ..... 28 min/both sides  
 14 min/one side  
 8-inch extended play disc ..... 40 min/both sides  
 20 min/one side  
 Spindle motor speed ..... 1,800 rpm  
 Standard play disc ..... 1,800 rpm (inner circumference)  
 Extended play disc ..... to 600 rpm (outer circumference)  
 (For a 12-inch disc)

### Compact Discs

DISC ..... Diameter: 5-inch, 3-inch, Thickness: 1.2 mm  
 Rotation direction (pickup side) ..... Counterclockwise  
 Linear speed ..... 1.2 - 1.4 m/sec  
 \*Maximum playing time ..... 74 min. 5-inch discs  
 20 min. 3-inch discs  
 (For stereo playback)

## 7. Functions

Remote control operations (CU-CLD085)

	Function	Standard play Disc (CAV)	Extended-play Disc (CLV)	Compact Disc with Video	Compact Disc
Basic Functions	Single-side play	YES	YES	YES	YES
	Pause	YES	YES	YES	YES
	Stop	YES	YES	YES	YES
Search	Fast forward (forward and reverse)	YES	YES	YES	YES
	Chapter/track skip	YES	YES	YES	YES
	Direct Chapter/track number search	YES	YES	YES	YES
	Frame number search	YES	NO	NO	NO
	Time number search	NO	YES	YES	YES
Time display	Elapsed time display	NO	YES	YES	YES
	Absolute time display	YES <sup>1</sup>	NO	NO	YES
	Remaining track time display	NO	NO	YES <sup>4</sup>	YES
	Remaining total time display	YES <sup>1</sup>	YES <sup>1</sup>	YES	YES
	Total number of selections, total time display	YES <sup>1</sup>	YES <sup>1</sup>	YES	YES
Others	CX system ON/OFF	YES <sup>2</sup>	YES <sup>2</sup>	NO	NO
	Auto Digital/Analog switch	YES <sup>3</sup>	YES <sup>3</sup>	NO	NO
	Audio channel selection (stereo, 1/L, 2/R)	YES	YES	YES	YES

\*1 Only discs with TOC

\*2 Valid for analog sound playing a disc with the  mark.

\*3 Can only be used with discs with digital sound tracks.

\*4 Audio part only

### NOTE:

The specifications and design of this product are subject to change without notice, due to improvements.

Published by Pioneer Electronic Corporation.  
 Copyright © 1993 Pioneer Electronic Corporation.  
 All rights reserved.

## PIONEER ELECTRONIC CORPORATION

PIONEER ELECTRONICS [USA] INC. 2265 East 220th Street, Long Beach, California 90810, U.S.A.

PIONEER ELECTRONICS OF CANADA, INC. 300 Allstate Parkway Markham, Ontario L3R 0P2, Canada

PIONEER ELECTRONIC [EUROPE] N.V. Haven 1087 Keetberglaan 1, 9120 Melsele, Belgium, TEL: 03/750.0511

PIONEER ELECTRONICS AUSTRALIA PTY. LTD. 178-184 Boundary Road, Braeside, Victoria 3195, Australia, TEL: [03] 580-9911

<93H04DF5D05>

Printed in Japan <DRB1141-B>

## Compact Discs with Video

Disc ..... Diameter: 5-inch, Thickness: 1.2 mm  
 Rotation direction (pickup side) ..... Counterclockwise  
 Linear speed ..... Audio portion: 1.2 - 1.4 m/sec  
 Video portion: 11 - 12 m/sec  
 \*Maximum playing time ..... Video portion: 5 min. (CLV)  
 Audio portion: 20 min. (Digital)

\*Actual playback time differs for each disc.

## 3. Video characteristics (two pairs)

Format ..... NTSC specifications  
 Video output  
 Level ..... 1 Vp-p nominal, sync. negative, terminated  
 Impedance ..... 75 Ω unbalanced  
 Jacks ..... Both RCA jacks

## 4. Audio characteristics (two pairs)

Output level  
 During analog audio output ..... 200 mVrms  
 (1 kHz, 40%)  
 During digital audio output ..... 200 mVrms  
 (1 kHz, -20 dB)  
 Jacks ..... Both RCA jacks  
 Number of channels ..... 2

## 5. Other Terminals

Control input/output ..... Both miniature jacks  
 Optical digital output ..... Optical digital jack  
 VHF ADAPTER output ..... JA-RF3L connection

## 6. Accessories

Remote control unit (CU-CLD085) ..... 1  
 Size "AAA" (IEC R03) dry cell batteries ..... 2  
 Video cord ..... 1  
 Audio cord ..... 1  
 Operating instructions ..... 1  
 Warranty card ..... 1

## PLAYER FUNCTIONS

- LaserActive compatible
- Digital Sound for LaserVision Discs
- Picture Stop Cancel Function
- Last Memory
- Digital Video Memory.