

# DATA SHEET

## **TDA1541A** Stereo high performance 16-bit DAC

Product specification  
File under Integrated Circuits, IC01

February 1991

## Stereo high performance 16-bit DAC

## TDA1541A

## FEATURES

- High sound quality
- High performance: low noise and distortion, wide dynamic range
- 4 × or 8 × oversampling possible
- Selectable two-channel input format
- TTL compatible inputs.

## GENERAL DESCRIPTION

The TDA1541A is a stereo 16-bit digital-to-analog converter (DAC). The ingenious design of the electronic circuit guarantees a high performance and superior sound quality. The TDA1541A is therefore extremely suitable for use in top-end hi-fi digital audio equipment such as high quality Compact Disc players or digital amplifiers.

## ORDERING INFORMATION

EXTENDED TYPE NUMBER	PACKAGE			
	PINS	PIN POSITION	MATERIAL	CODE
TDA1541A <sup>(1)</sup>	28	DIL	plastic	SOT117

## Note

1. SOT117; SOT117-1; 1996 August 09.

## QUICK REFERENCE DATA

SYMBOL	PARAMETER	CONDITIONS	MIN.	TYP.	MAX.	UNIT
V <sub>DD</sub>	supply voltage; pin 28		4.5	5.0	5.5	V
-V <sub>DD1</sub>	supply voltage; pin 26		4.5	5.0	5.5	V
-V <sub>DD2</sub>	supply voltage; pin 15		14.0	15.0	16.0	V
I <sub>DD</sub>	supply current; pin 28		–	27	40	mA
-I <sub>DD1</sub>	supply current; pin 26		–	37	50	mA
-I <sub>DD2</sub>	supply current; pin 15		–	25	35	mA
THD	total harmonic distortion	including noise at 0 dB	–	–95	–90	dB
			–	0.0018	0.0032	%
THD	total harmonic distortion	including noise at –60 dB	–	–42	–	dB
			–	0.79	–	%
NL	non-linearity	at T <sub>amb</sub> = –20 to +85 °C	–	0.5	1.0	LSB
t <sub>cs</sub>	current settling time to ± 1LSB		–	0.5	–	µs
BR	input bit rate at data input; (pin 3 and 4)		–	–	6.4	Mbits/s
f <sub>BCK</sub>	clock frequency at clock input		–	–	6.4	MHz
TC <sub>FS</sub>	full scale temperature coefficient	at analog (AOL;AOR)	–	±200 × 10 <sup>-6</sup>	–	K <sup>-1</sup>
T <sub>amb</sub>	operating ambient temperature range		–40	–	+85	°C
P <sub>tot</sub>	total power dissipation		–	700	–	mW

Stereo high performance 16-bit DAC

TDA1541A

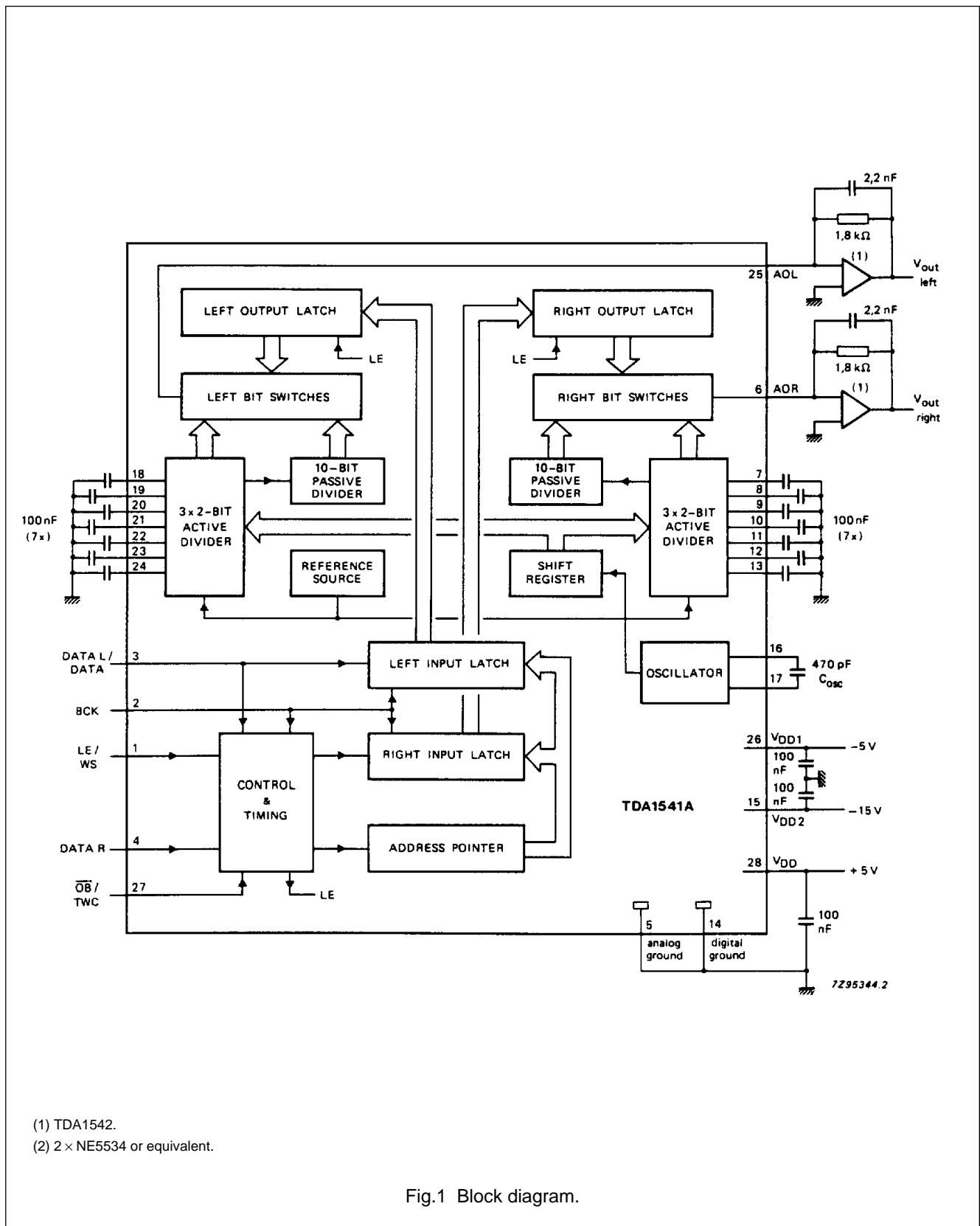

## Stereo high performance 16-bit DAC

TDA1541A

## PINNING

SYMBOL	PIN	DESCRIPTION
LE/WS <sup>(1)</sup>	1	latch enable input/ word select input
BCK <sup>(1)</sup>	2	bit clock input
DATA L /DATA <sup>(1)</sup>	3	data left channel input/ data input (selected format)
DATA R <sup>(1)</sup>	4	data right channel input
GND(A)	5	analog ground
AOR	6	right channel output
DECOU	7 to 13	decoupling
GND (D)	14	digital ground
V <sub>DD2</sub>	15	-15 V supply voltage
COSC	16,17	oscillator
DECOU	18 to 24	decoupling
AOL	25	left channel output
V <sub>DD1</sub>	26	-5 V supply voltage
$\overline{\text{OB}}/\text{TWC}^{(1)}$	27	mode select input
V <sub>DD</sub>	28	+5 V supply voltage

## Note

- See Table 1 data selection input.

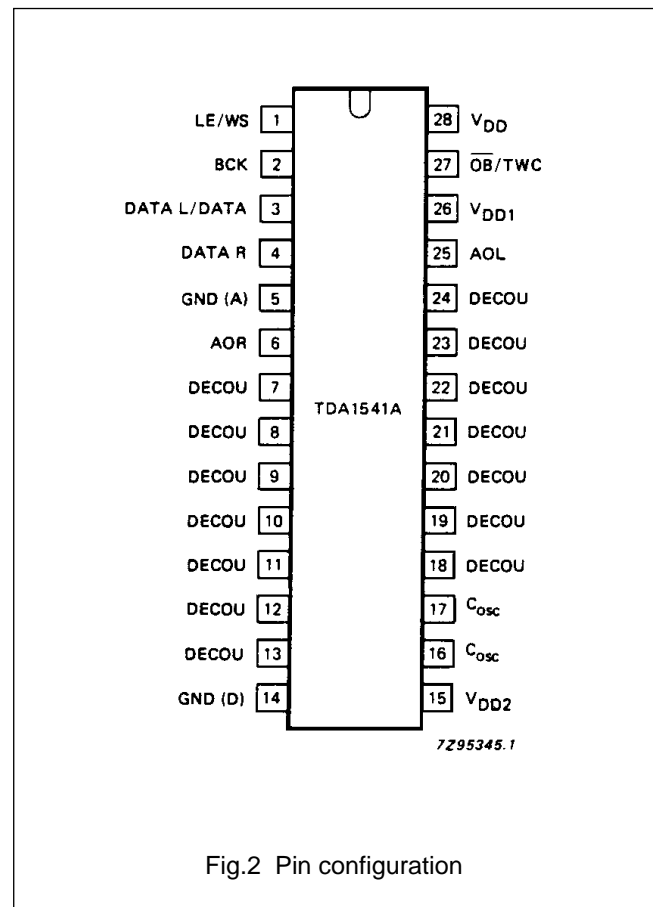

Fig.2 Pin configuration

## FUNCTIONAL DESCRIPTION

The TDA1541A accepts input sample formats in time multiplexed mode or simultaneous mode up to 16-bit word length. The most significant bit (MSB) must always be first. The flexible input data format allows easy interfacing with signal processing chips such as interpolation filters, error correction circuits, pulse code modulation adaptors and audio signal processors (ASP).

The high maximum input bit-rate and fast setting facilitates application in  $8 \times$  oversampling systems (44.1 kHz to 352.8 kHz or 48 kHz to 384 kHz) with the associated simple analog filtering function (low order, linear phase filter).

## Input data selection (see also Table 1)

With the input  $\overline{\text{OB}}/\text{TWC}$  connected to ground, data input (offset binary format) must be in time multiplexed mode. It is accompanied with a word select (WS) and a bit clock input (BCK) signal. The converted samples appear at the output, at the first positive going transition of the bit clock signal after a negative going transition of the word select signal.

With  $\overline{\text{OB}}/\text{TWC}$  connected to V<sub>DD</sub> the mode is the same but the data format must be in the two's complement.

When input  $\overline{\text{OB}}/\text{TWC}$  input is connected to V<sub>DD1</sub> the two channels of data (L/R) are input simultaneously via DATA L and DATA R, accompanied with BCK and a latch-enable input (LE). With this mode selected the data must be in offset binary. The converted samples appear at the output at the positive going transition of the latch enable signal.

The format of the data input signals is shown in Fig.5 and 6.

## Stereo high performance 16-bit DAC

TDA1541A

True 16-bit performance is achieved by each channel using three 2-bit active dividers, operating on the dynamic element matching principle, in combination with a 10-bit passive current divider, based on emitter scaling. All digital inputs are TTL compatible.

**Table 1** Input data selection

$\overline{\text{OB}}/\text{TWC}$	MODE	PIN 1	PIN 2	PIN 3	PIN 4
-5 V	simultaneous	LE	BCK	DATA L	DATA R
0 V	time MUX OB	WS	BCK	DATA OB	not used
+5 V	time MUX TWC	WS	BCK	DATA TWC	not used

**Where:**

LE	= latch enable
WS	= word select, LOW = left channel; HIGH = right channel
BCK	= bit clock
DATA L	= data left
DATA R	= data right
DATA OB	= data offset binary
DATA TWC	= data two's complement
MUX OB	= multiplexed offset binary
MUX TWC	= multiplexed two's complement = I <sup>2</sup> S- format

**LIMITING VALUES**

In accordance with the Absolute Maximum System (IEC 134)

SYMBOL	PARAMETER	CONDITIONS	MIN.	MAX.	UNIT
$V_{DD}$	supply voltage; pin 28		0	7	V
$-V_{DD1}$	supply voltage; pin 26		0	7	V
$-V_{DD2}$	supply voltage; pin 15		0	17	V
$T_{stg}$	storage temperature range		-55	+150	°C
$T_{amb}$	operating ambient temperature range		-40	+85	°C
$V_{es}$	electrostatic handling*		-1000	+1000	V

\* Equivalent to discharging a 100 pF capacitor through a 1.5 k $\Omega$  series resistor.

**THERMAL RESISTANCE**

SYMBOL	PARAMETER	TYP.	UNIT
$R_{th\ j-a}$	from junction to ambient	30	K/W

## Stereo high performance 16-bit DAC

## TDA1541A

**CHARACTERISTICS**

$V_{DD} = 5\text{ V}$ ;  $-V_{DD1} = 5\text{ V}$ ;  $-V_{DD2} = 15\text{ V}$ ;  $T_{\text{amb}} = +25\text{ °C}$ ; measured in the circuit of Fig.1; unless otherwise specified

SYMBOL	PARAMETER	CONDITIONS	MIN.	TYP.	MAX.	UNIT
<b>Supply</b>						
$V_{DD}$	supply voltage; pin 28		4.5	5.0	5.5	V
$-V_{DD1}$	supply voltage; pin 26		4.5	5.0	5.5	V
$-V_{DD2}$	supply voltage; pin 15		14.0	15.0	16.0	V
$V_{GND(A)}$ $-V_{GND(D)}$	voltage difference between analog and digital ground		-0.3	0	+0.3	V
$I_{DD}$	supply current; pin 28		-	27	40	mA
$-I_{DD1}$	supply current; pin 26		-	37	50	mA
$-I_{DD2}$	supply current; pin 15		-	25	35	mA
<b>Inputs</b>						
$-I_{IL}$	input current pins (1, 2, 3 and 4) digital inputs LOW	$V_I = 0.8\text{ V}$	-	-	0.4	mA
$I_{IH}$	digital inputs HIGH	$V_I = 2.0\text{ V}$	-	-	20	$\mu\text{A}$
$ I_{OB/TWC} $	Digital input currents (pin 27) +5 V		-	-	1	$\mu\text{A}$
$ I_{OB/TWC} $	0 V		-	-	20	$\mu\text{A}$
$ I_{OB/TWC} $	-5 V		-	-	40	$\mu\text{A}$
$f_{BCK}$	input frequency/bit rate clock input pin 2		-	-	6.4	MHz
BR	bit rate data input pin 3 and 4		-	-	6.4	Mbits/s
$f_{WS}$	word select input pin 2		-	-	200	kHz
$f_{LE}$	latch enable input 1		-	-	200	kHz
$C_I$	input capacitance of digital inputs		-	12	-	pF
<b>Analog outputs (AOL;AOR; see note 1)</b>						
Res	resolution		-	16	-	bits
$I_{FS}$	full scale current		3.4	4.0	4.6	mA
$ I_{ZS} $	zero scale current		-	25	50	nA
$T_{CFS}$	full scale temperature coefficient	$T_{\text{amb}} =$ -20 to +85 °C	-	$\pm 200 \times$ $10^{-6}$	-	$\text{K}^{-1}$
<b>Analog outputs (<math>V_{\text{ref}}</math>)</b>						
$E_L$	integral linearity error	$T_{\text{amb}} = 25\text{ °C}$	-	0.5	1.0	LSB
$E_L$	integral linearity error	$T_{\text{amb}} =$ -20 to +85 °C	-	-	1.0	LSB
$E_{dL}$	differential linearity error	$T_{\text{amb}} = 20\text{ °C}$ , note 2	-	0.5	1.0	LSB
$E_{dL}$	differential linearity error	$T_{\text{amb}} =$ -20 to +85 °C	-	-	1.0	LSB
THD	total harmonic distortion	at 0 dB; note 3	-100	-	-	dB
			-	0.0010	-	%

## Stereo high performance 16-bit DAC

## TDA1541A

SYMBOL	PARAMETER	CONDITIONS	MIN.	TYP.	MAX.	UNIT
THD	total harmonic distortion	including noise at 0 dB; note 3, Fig. 3, 4	–	–95	–90	dB
			–	0.0018	0.0032	%
THD	total harmonic distortion	including noise at –60 dB; note 3, Fig. 3, 4	–	–42	–	dB
			–	0.79	–	%
$t_{cs}$	settling time $\pm 1$ LSB		–	0.5	–	$\mu s$
$\alpha$	channel separation		90	98	–	dB
$ d_{IO} $	unbalance between outputs	note 4	–	< 0.1	0.3	dB
$ t_d $	time delay between outputs		–	–	0.2	$\mu s$
SSVR	supply voltage ripple rejection	$V_{DD} = +5 V$ ; note 4	–	–76	–	dB
SSVR	supply voltage ripple rejection	$V_{DD1} = -5 V$ ; note 4	–	–84	–	dB
SSVR	supply voltage ripple rejection	$V_{DD2} = -15 V$ ; note 4	–	–58	–	dB
S/N	signal-to-noise ratio	at bipolar zero	–	110	–	dB
S/N	signal-to-noise ratio	at full scale	98	104	–	dB
<b>Timing (Fig. 5 and 6)</b>						
$t_r$	rise time		–	–	32	ns
$t_f$	fall time		–	–	32	ns
$t_{CY}$	bit clock cycle time		156	–	–	ns
$t_{HB}$	bit clock HIGH time		46	–	–	ns
$t_{LB}$	bit clock LOW time		46	–	–	ns
$t_{FBRL}$	bit clock fall time to latch enable rise time		0	–	–	ns
$t_{RBFL}$	bit clock rise time to latch enable fall time		0	–	–	ns
$t_{SU;DAT}$	data set-up time		32	–	–	ns
$t_{HD;DAT}$	data hold time to bit clock		0	–	–	ns
$t_{HD;WS}$	word select hold time		0	–	–	ns
$t_{SU;WS}$	word select set-up time		32	–	–	ns

**Notes to the characteristics**

- To ensure no performance losses, permitted output voltage compliance is  $\pm 25$  mV maximum.
- Selections have been made with respect to the maximum differential linearity error ( $E_{dL}$ ):

TDA1541A/N2	bit 1-16	$E_{dL} < 1$ LSB
TDA1541A/N2/R1	bit 1-16	$E_{dL} < 2$ LSB
TDA1541A/N2/S1	bit 1-7	$E_{dL} < 0.5$ LSB
	bit 8-15	$E_{dL} < 1$ LSB
	bit 16	$E_{dL} < 0.75$ LSB

# Stereo high performance 16-bit DAC

# TDA1541A

The S1 version has been specially selected to achieve extremely good performance even for small signals.

3. Measured using a 1 kHz sinewave generated at a sampling rate of 176.4 kHz.
4.  $V_{\text{ripple}} = 100 \text{ mV}$  and  $f_{\text{ripple}} = 100 \text{ Hz}$ .

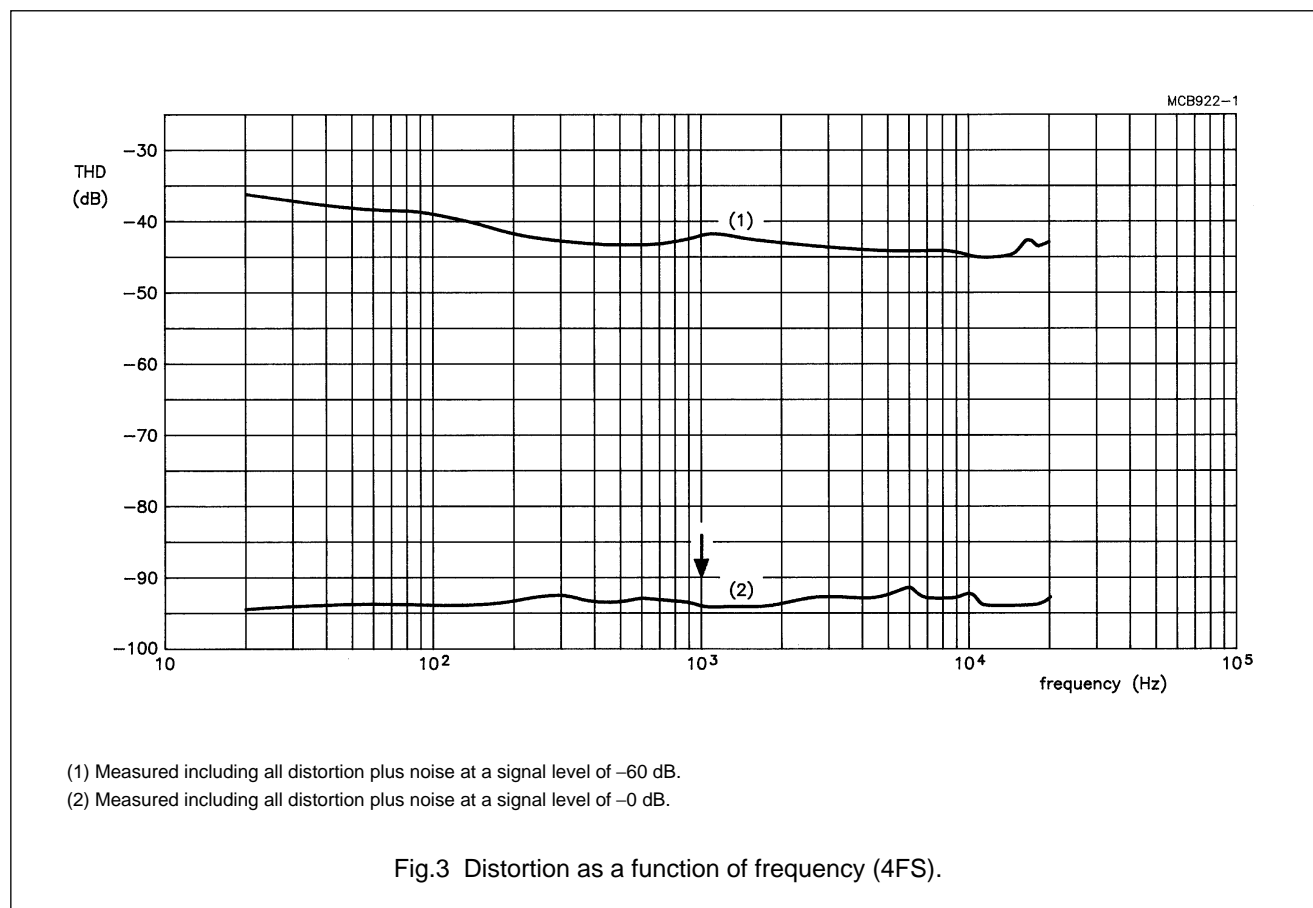

### Notes to Fig.3

- The sample frequency 4FS: 176.4 kHz.
- Ref: 0 dB is the output level of a full scale digital sine wave stimulus.



Stereo high performance 16-bit DAC

TDA1541A

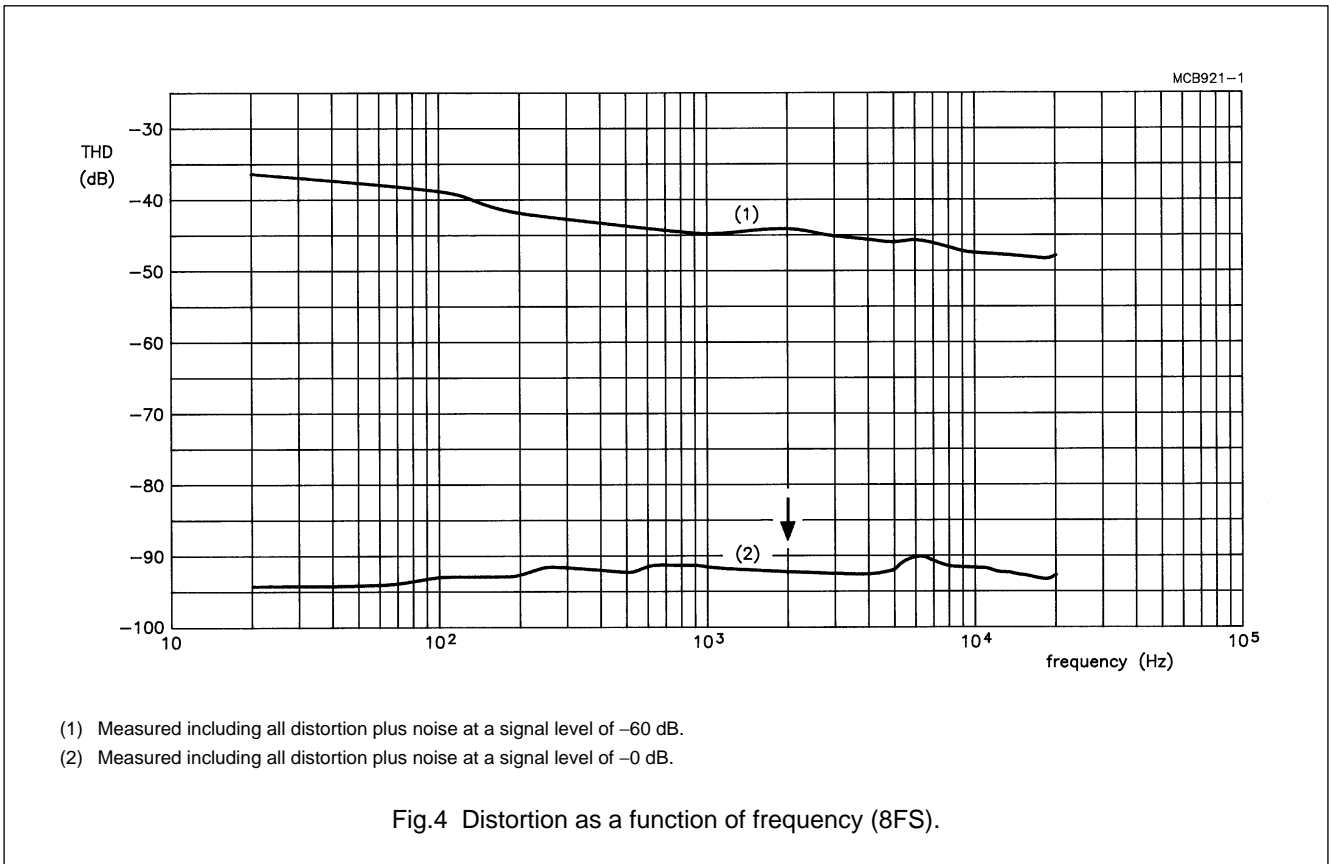

**Notes to Fig.4**

- The sample frequency 8FS: 352.8 kHz.
- Ref: 0 dB is the output level of a full scale digital sine wave stimulus.

Stereo high performance 16-bit DAC

TDA1541A

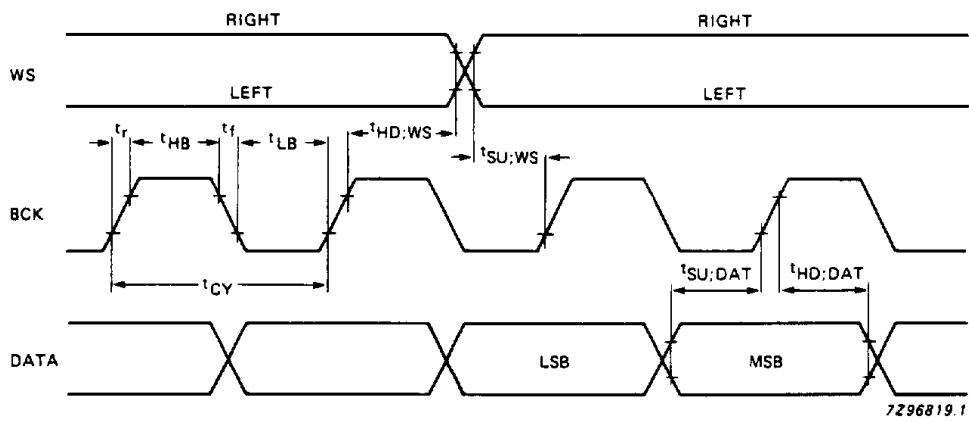

Fig.5 Format of input signals; time multiplexed (I²S format).

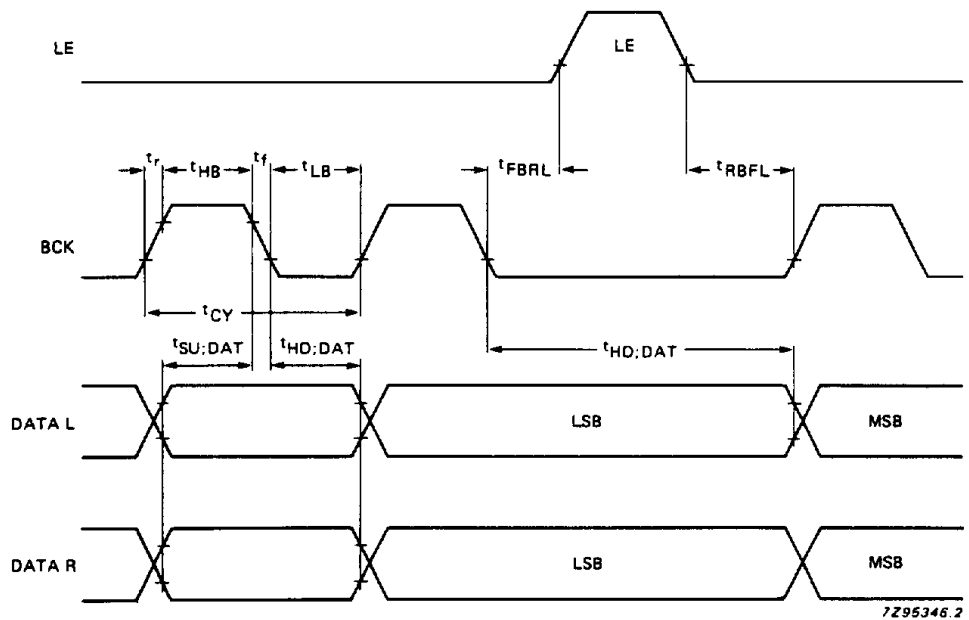

Fig.6 Format of input signals; simultaneous data.

Stereo high performance 16-bit DAC

TDA1541A

PACKAGE OUTLINE

DIP28: plastic dual in-line package; 28 leads (600 mil)

SOT117-1

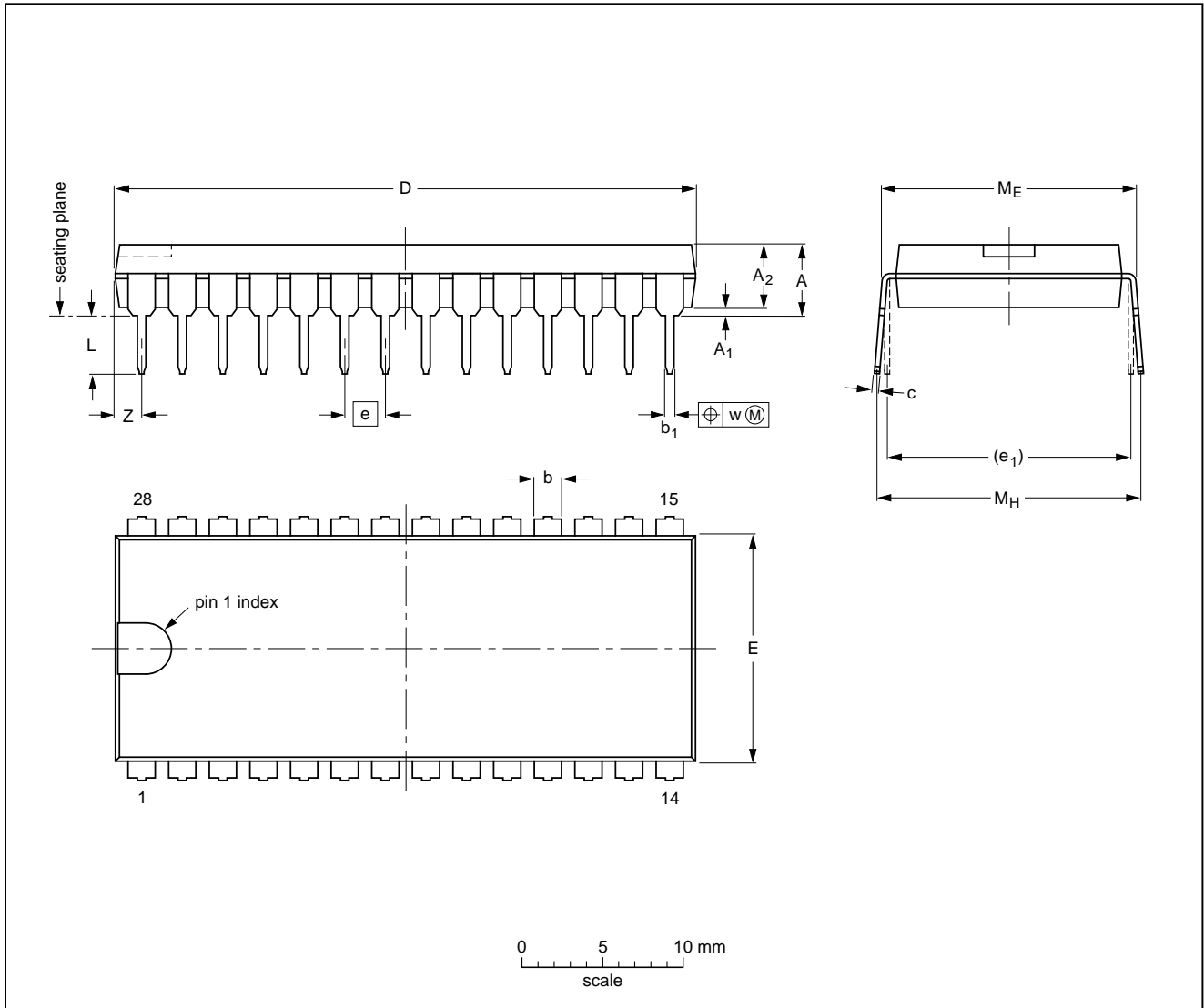

DIMENSIONS (inch dimensions are derived from the original mm dimensions)

UNIT	A max.	A <sub>1</sub> min.	A <sub>2</sub> max.	b	b <sub>1</sub>	c	D <sup>(1)</sup>	E <sup>(1)</sup>	e	e <sub>1</sub>	L	M <sub>E</sub>	M <sub>H</sub>	w	Z <sup>(1)</sup> max.
mm	5.1	0.51	4.0	1.7 1.3	0.53 0.38	0.32 0.23	36.0 35.0	14.1 13.7	2.54	15.24	3.9 3.4	15.80 15.24	17.15 15.90	0.25	1.7
inches	0.20	0.020	0.16	0.066 0.051	0.020 0.014	0.013 0.009	1.41 1.34	0.56 0.54	0.10	0.60	0.15 0.13	0.62 0.60	0.68 0.63	0.01	0.067

Note

1. Plastic or metal protrusions of 0.25 mm maximum per side are not included.

OUTLINE VERSION	REFERENCES				EUROPEAN PROJECTION	ISSUE DATE
	IEC	JEDEC	EIAJ			
SOT117-1	051G05	MO-015AH				92-11-17 95-01-14

# Stereo high performance 16-bit DAC

# TDA1541A

## SOLDERING

### Introduction

There is no soldering method that is ideal for all IC packages. Wave soldering is often preferred when through-hole and surface mounted components are mixed on one printed-circuit board. However, wave soldering is not always suitable for surface mounted ICs, or for printed-circuits with high population densities. In these situations reflow soldering is often used.

This text gives a very brief insight to a complex technology. A more in-depth account of soldering ICs can be found in our "IC Package Databook" (order code 9398 652 90011).

### Soldering by dipping or by wave

The maximum permissible temperature of the solder is 260 °C; solder at this temperature must not be in contact with the joint for more than 5 seconds. The total contact time of successive solder waves must not exceed 5 seconds.

The device may be mounted up to the seating plane, but the temperature of the plastic body must not exceed the specified maximum storage temperature ( $T_{stg\ max}$ ). If the printed-circuit board has been pre-heated, forced cooling may be necessary immediately after soldering to keep the temperature within the permissible limit.

### Repairing soldered joints

Apply a low voltage soldering iron (less than 24 V) to the lead(s) of the package, below the seating plane or not more than 2 mm above it. If the temperature of the soldering iron bit is less than 300 °C it may remain in contact for up to 10 seconds. If the bit temperature is between 300 and 400 °C, contact may be up to 5 seconds.

## DEFINITIONS

<b>Data sheet status</b>	
Objective specification	This data sheet contains target or goal specifications for product development.
Preliminary specification	This data sheet contains preliminary data; supplementary data may be published later.
Product specification	This data sheet contains final product specifications.
<b>Limiting values</b>	
Limiting values given are in accordance with the Absolute Maximum Rating System (IEC 134). Stress above one or more of the limiting values may cause permanent damage to the device. These are stress ratings only and operation of the device at these or at any other conditions above those given in the Characteristics sections of the specification is not implied. Exposure to limiting values for extended periods may affect device reliability.	
<b>Application information</b>	
Where application information is given, it is advisory and does not form part of the specification.	

## LIFE SUPPORT APPLICATIONS

These products are not designed for use in life support appliances, devices, or systems where malfunction of these products can reasonably be expected to result in personal injury. Philips customers using or selling these products for use in such applications do so at their own risk and agree to fully indemnify Philips for any damages resulting from such improper use or sale.