

IMPORTANT



The lightning flash with arrowhead, within an equilateral triangle, is intended to alert the user to the presence of uninsulated "dangerous voltage" within the product's enclosure that may be of sufficient magnitude to constitute a risk of electric shock to persons.

CAUTION

RISK OF ELECTRIC SHOCK
DO NOT OPEN

CAUTION:
TO PREVENT THE RISK OF ELECTRIC SHOCK, DO NOT REMOVE COVER (OR BACK). NO USER-SERVICEABLE PARTS INSIDE. REFER SERVICING TO QUALIFIED SERVICE PERSONNEL.



The exclamation point within an equilateral triangle is intended to alert the user to the presence of important operating and maintenance (servicing) instructions in the literature accompanying the appliance.

SAFETY INSTRUCTIONS

READ INSTRUCTIONS – All the safety and operating instructions should be read before the appliance is operated.

RETAIN INSTRUCTIONS – The safety and operating instructions should be retained for future reference.

HEED WARNINGS – All warnings on the appliance and in the operating instructions should be adhered to.

FOLLOW INSTRUCTIONS – All operating and use instructions should be followed.

CLEANING – Unplug this video product from the wall outlet before cleaning. Do not use liquid or aerosol cleaners. Use a damp cloth for cleaning.

ATTACHMENTS – Do not use attachments not recommended by the video product manufacturer as they may cause hazards.

WATER AND MOISTURE – Do not use this video product near water – for example, near a bathtub, wash bowl, kitchen sink, or laundry tub; in a wet basement, or near a swimming pool, etc.

ACCESSORIES – Do not place this video product on an unstable cart, stand, tripod, bracket, or table. The video product may fall, causing serious injury to a child or adult, and serious damage to the appliance. Use only with a cart, stand, tripod, bracket, or table recommended by the manufacturer, or sold with the video product. Any mounting of the appliance should follow the manufacturer's instructions, and should use a mounting accessory recommended by the manufacturer.

CART – An appliance and cart combination should be moved with care. Quick stops, excessive force, and uneven surfaces may cause the appliance and cart combination to overturn.

POLARIZATION – This video product is equipped with a polarized alternating current line plug (a plug having one blade wider than the other). This plug will fit into the power outlet only one way. This is a safety feature. If you are unable to insert the plug fully into the outlet, try reversing the plug. If the plug should still fail to fit, contact your electrician to replace your obsolete outlet. Do not defeat the safety purpose of the polarized plug.

LIGHTNING – For added protection for this video product receiver during a lightning storm, or when it is left unattended and unused for long periods of time, unplug it from the wall outlet and disconnect the antenna or cable system. This will prevent damage to the video product due to lightning and power-line surges.

POWER LINES – An outside antenna system should not be located in the vicinity of overhead power lines or other electric light or power circuits, or where it can fall into such power lines or circuits. When installing an outside antenna system, extreme care should be taken to keep from touching such power lines or circuits as contact with them might be fatal.

OVERLOADING – Do not overload wall outlets and extension cords as this can result in the risk of fire or electric shock.

OBJECT AND LIQUID ENTRY – Never push objects of any kind into this video product through openings as they may touch dangerous voltage points or short-out parts that could result in a fire or electric shock. Never spill liquid of any kind on the video product.

SERVICING – Do not attempt to service this video product yourself as opening or removing covers may expose you to dangerous voltage or other hazards. Refer all servicing to qualified service personnel.

DAMAGE REQUIRING SERVICE

Unplug this video product from the wall outlet and refer servicing to qualified service personnel under the following conditions:

- When the power-supply cord or plug is damaged.
- If liquid has been spilled, or objects have fallen into the video product.
- If the video product has been exposed to rain or water.
- If the video product does not operate normally by following the operating instructions. Adjust only those controls that are covered by the operating instructions. Improper adjustment of other controls may result in damage and will often require extensive work by a qualified technician to restore the video product to its normal operation.
- If the video product has been dropped or the cabinet has been damaged.
- When the video product exhibits a distinct change in performance – this indicates a need for service.

REPLACEMENT PARTS – When replacement parts are required, be sure the service technician has used replacement parts specified by the manufacturer or having the same characteristics as the original part. Unauthorized substitutions may result in a fire, electric shock or other hazards.

SAFETY CHECK – Upon completion of any service or repairs to this video product, ask the service technician to perform safety checks to determine that the video product is in proper operating condition.

OUTDOOR ANTENNA GROUNDING – If an outside antenna is connected to the antenna terminal, be sure the antenna system is grounded so as to provide some protection against voltage surges and buildup static charges.

In the U.S.A., section 810 of the National Electrical Code, ANSI/NFPA 70, provides information with respect to proper grounding of the mast and supporting structure, grounding of the lead-in wire to an antenna discharge unit, size of grounding conductors, location of antenna-discharge unit, connection to grounding electrodes, and requirements for the grounding electrode. See Fig. A.

NEC – NATIONAL ELECTRIC CODE



VENTILATION – Slots and openings in the cabinet are provided for ventilation and to ensure reliable operation of the video product and to protect it from overheating. These openings must not be blocked or covered. They should never be blocked by placing the video product on a bed, sofa, rug, or other similar surface. This video product should never be placed near or over a radiator or heat register. This video product should not be placed in a built-in installation such as a bookcase or rack unless proper ventilation is provided or the manufacturer's instructions have been adhered to.

POWER SOURCES – This video product should be operated only from the type of power source indicated on the marking label. If you are not sure of the type of power supply to your home, consult your appliance dealer or local power company. For video products intended to operate from battery power, or other sources, refer to the operating instructions.

POWER-CORD PROTECTION

Power-supply cords should be routed so that they are not likely to be walked on or pinched by items placed upon or against them. Pay particular attention to cords at plugs, convenience receptacles, and the point where they exit from the appliance.

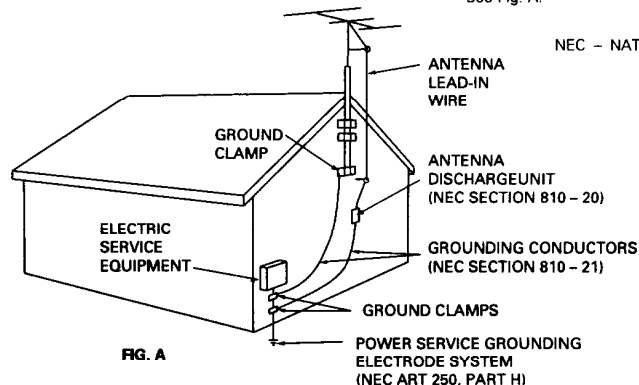

FIG. A

Thank you for your purchase of the ONKYO DX-V500 CD CDV LD COMPATIBLE player. Please read this manual thoroughly before making connections and plugging in the AC power cord. Following the instructions in this manual will enable you to obtain optimum performance and maximum listening enjoyment from your new DX-V500. Please retain this manual for future reference.

Feature

- A/B both side automatic playback
- Independent doors for LD and CD/CDV
- KARAOKE function (Mic jack/Echo)
- One-touch KARAOKE to mute the voice of the singers from a disc
- Digital key control (Up/Down 5 steps)
- Quick reverse
- Cinema bass (Level 1/2/3)
- Last memory function
- On-screen display
- AC-3 RF-out used with Dolby AC-3 components

- Optical digital output
- Hilite/Intro Scan (remote control only)
- Jog dial and Shuttle ring for searching a scene (remote control only)
- Multi speed function (remote control only)
- Attenuator switch for KARAOKE singing
- Auto power-on function

WARNING : TO PREVENT FIRE OR SHOCK HAZARD, DO NOT EXPOSE THIS APPLIANCE TO RAIN OR MOISTURE.

CAUTION :

This product satisfies FCC regulations when shielded cables and connectors are used to connect the unit to other equipment. To prevent electromagnetic interference with electric appliances such as radios and televisions, use shielded cables and connectors for connections.

THE POWER SWITCH IS SECONDARY CONNECTED AND THEREFORE DOES NOT SEPARATE THE UNIT FROM MAINS POWER IN STANDBY POSITION.

CONTENTS

PRECAUTIONS	4
ACCESSORIES	5
TYPES OF DISCS WHICH CAN BE PLAYED WITH THIS UNIT	6
GLOSSARY	7
CONNECTIONS	8
NAMES OF PARTS	
FRONT PANEL	10
DISPLAY WINDOW	10
REMOTE CONTROL UNIT	11
BASIC OPERATION (PLAYBACK OF A DISC)	12
MOVIE DISC ENTERTAINMENT	14
SINGING ALONG WITH KARAOKE ENTERTAINMENT	15
APPLIED OPERATIONS	16
QUICK SCANNING OF DISC CONTENTS	20
RANDOM PLAYBACK (PLAYBACK IN ORDER SELECTED BY THE PLAYER)	20
TO SEARCH FOR A DESIRED FRAME	21
PROGRAMMED PLAYBACK (PLAYING CHAPTERS/TRACKS BY CHANGING THEIR ORDER AS REQUIRED)	22
REPEAT PLAYBACK	23
ON-SCREEN DISPLAY	24
TROUBLESHOOTING	25
SPECIFICATIONS	27

This equipment has been tested and found to comply with the limits for a Class B digital device, pursuant to Part 15 of the FCC Rules. These limits are designed to provide reasonable protection against harmful interference in a residential installation. This equipment generates, uses, and can radiate radio frequency energy and, if not installed and used in accordance with the instructions, may cause harmful interference to radio communications. However, there is no guarantee that interference will not occur in a particular installation. If this equipment does cause harmful interference to radio or television reception, which can be determined by turning the equipment off and on, the user is encouraged to try to correct the interference by one or more of the following measures:

- Reorient or relocate the receiving antenna.
- Increase the separation between the equipment and receiver.
- Connect the equipment into an outlet on a circuit different from that to which the receiver is connected.
- Consult the dealer or an experienced radio/TV technician for help.

Information to User

Alteration or modifications carried out without appropriate authorization may invalidate the user's right to operate the equipment.

CAUTION

- Use of controls or adjustments or performance of procedures other than those specified herein may result in hazardous radiation exposure.
- The use optical instruments with this product will increase eye hazard.

PRECAUTIONS

If it becomes necessary to transport or ship this unit in the future, be sure to first remove the disc (if loaded), and retract the disc table to its closed position. Then turn the power off, and, after the "-OFF-" display goes out on the display, disconnect the power cord.

INSTALLING THE PLAYER

- Place the player on a stable platform next to the television and stereo system to be used with the player.
- Do not place heavy objects such as a television or TV monitor on top of the player.
- Do not place the player on top of your TV set or TV monitor. Also, keep the player away from devices such as cassette decks which are sensitive to magnetic fields.

DO NOT INSTALL THE PLAYER IN THE FOLLOWING LOCATIONS

- In a place subject to direct sunlight.
- In humid or poorly ventilated places.
- In extremely hot or cold places.
- In a place subject to vibrations.
- In a dusty place.
- In a place subject to soot, steam or heat (in a kitchen, etc.)

AVOID SOURCES OF HEAT

Do not put the player on sources of heat, such as an amplifier. When installing with audio components that generate heat, by placing the player below such components where there is adequate ventilation and not much dust. Avoid placing the player on surfaces such as shaggy carpets, beds, and sofas which may block ventilation under the player and cause damage.

CAUTION

Even when the player is in the pause mode, the disc-drive motor is still revolving. Since leaving the player in this condition can shorten the lifetime of the motor, do not leave the player in the pause mode for long periods of time. Also, to prevent damage to the screen, do not use the unit for long periods of time under conditions in which the screen display (monitor) is displaying characters (for example, power-ON mode, CD PLAYER, PAUSE) With an LD disc, if playback is paused for about 20 minutes, the player will automatically enter stop mode.

STRIPE PATTERNS APPEARING ON A TV PROGRAM

Stripe patterns may appear during a TV program if the player unit is turned on, depending on the quality of reception of the TV station. This is neither a malfunction of the television nor the player. If stripes appear while watching the TV, or when

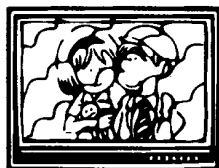

When FM or AM stations are being received, signal noise may be generated if the player is turned on. Turn off the player when not in use. Also, if there is signal noise when receiving radio stations with an indoor antenna, adjust the position or direction of the antenna.

CONDENSATION

Moisture will form in the operating section of the player if the player is brought from cool surroundings into a warm room or if the temperature of the room rises suddenly. When this happens, player's performance will be impaired.

To prevent this, let the player stand in its new surroundings for about an hour before switching it on, or make sure that the room temperature rises gradually.

Condensation may also form during the summer if the player is exposed to the breeze from an air conditioner. In such cases, change the location of the player.

POWER-CORD CAUTION

Handle the power cord by the plug. Do not pull out the plug by tugging the cord and never touch the power cord when your hands are wet as this could cause a short circuit or electric shock. Do not place the unit, a piece of furniture, etc., on the power cord, or pinch the cord. Never make a knot in the cord or tie it with other cords. The power cords should be routed in such a way that they are not likely to be stepped on. A damaged power cord can cause a fire or give you an electrical shock. Check the power cord once in a while. When you find it damaged, ask your dealer for a replacement.

CLEANING CARE

Use a soft, dry cloth for cleaning. For stubborn dirt, soak the cloth in a weak detergent solution; wring well first and wipe. Use a dry cloth to wipe it dry. Do not use any volatile agents such as benzene or paint thinner, as they may damage the surface of the player.

Abnormal functioning of this unit may be caused by static electricity or other external interference. To restore normal operation, unplug the AC power cord and then plug it in again.

Only one disc can be loaded at any one time. Loading a LaserDisc, a Compact Disc, a 3-inch (8-cm) Compact Disc or a Compact Disc with Video on top of one another may result in a breakdown, or in scratching of the discs. Please only load one disc at a time.

This player is to be used exclusively with the NTSC color system. Please use an NTSC LaserDisc only. PAL and SECAM system discs cannot be used with this player.

ACCESSORIES

When unpacking the player, first check to make sure that all of the accessories listed below are supplied.

- Remote control unit
- Size "AAA" (IEC R03) dry cell batteries x 2

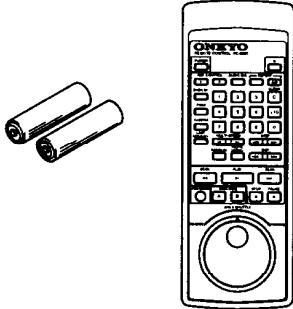

- Video cord (RCA plug ↔ RCA plug)
Use to connect the player to a TV etc.

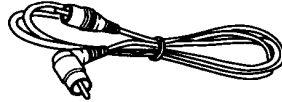

- Power cord

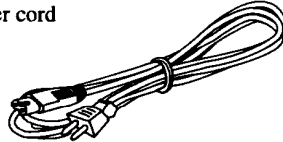

- Audio cord (RCA plug x 2 ↔ RCA plug x 2)
Use to connect the player to a TV etc.

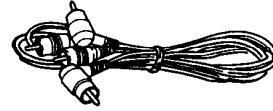

- Power source plug adapter

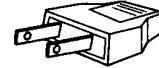

- Instruction manual

INSERTING BATTERIES INTO THE REMOTE CONTROL UNIT

- 1 Open the battery compartment cover on the back of the remote control unit. Press the knob and open the cover in the direction of the arrow.
- 2 Take out the two accessory size "AAA" (IEC R03) dry cell batteries, and insert them into the battery compartment in accordance with the display (⊕, ⊖) inside the compartment.
- 3 Close the cover of the battery compartment.

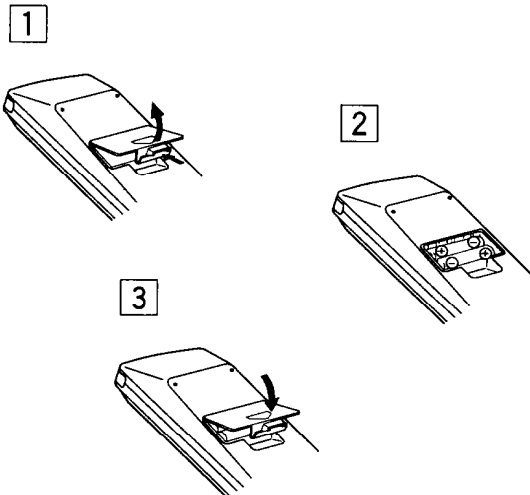











In correct use of batteries may cause leakage or rupture. Always be sure to follow these guidelines:



- A. Always insert batteries into the battery compartment correctly matching the positive ⊕ and negative ⊖ polarities, as shown by the display inside the compartment.
- B. Never mix new and used batteries.
- C. Batteries of the same size may have different voltages, depending on brand. Do not mix different brands of batteries.

TYPES OF DISCS WHICH CAN BE PLAYED WITH THIS UNIT

This unit is a CD/CDV/LD compatible laserdisc player.

- The marks shown in the following table are found on the label or jacket of each disc.
This player is capable of playing the 7 types of discs listed below without using an adapter.
- To prevent a malfunction, do not use an 8-cm adapter (for CD) or a 20-cm adapter (for LD).

Types of playable discs and their marks	Diameter/Playable sides	Max. playback time
 CD	CD 12 cm / single-side 	74 minutes
	CD single 8 cm / single-side 	20 minutes
 CDV **	CDV 12 cm / single-side 	Digital audio 20 min. Digital audio + Video 5 min.
 VSD VIDEO SINGLE DISC	VSD 12 cm / single-side 	Digital audio + Video 5 min.
 LASER DISC	LD 30 cm / double-side 	CAV 1 hour CLV 2 hours
	LD 20 cm / double-side 	CAV 28 min. CLV 40 min.
	LD single 20 cm / single-side 	CAV 14 min. CLV 20 min.

- There are some discs marked with the  mark instead of the  mark.
- There are some discs without the  LD mark.

* This is the unified symbol mark of LASERDISC (LaserVision videodisc).
LaserDisc players and discs which bear this symbol and use the same television system, are mutually compatible.

** A Digital Audio with Multi Audio Disc (CD VIDEO LD) and a CDV (CD Video CDV) are referred to as CD Video discs. CD Videodiscs are recorded with subcodes, which are the non-audio recordings of TOC (Table of Contents) data such as track numbers, index numbers, etc. However, there are some discs without these marks.

NOTE:





Only the above-mentioned discs can be played with this unit. For example, Video CD, CD-ROM, LD-ROM, CD Graphics and High Vision LD discs can not be played with this unit.

Caution

VIDEO CD  or  cannot be played with this player.

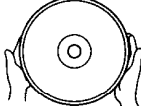
The Video CD is a disc holding up to 74 minutes of digital video and audio signals, when recorded in the MPEG format.

How to hold a disc

	LD	CD, CDV
Holding with two hands Hold by two opposite edges of the disc.		
Holding with one hand Hold by hooking two fingers across the center hole and edge.		

Do not attach paper.
Do not touch the disc surfaces.



Never use a cracked or warped disc.

To avoid danger, never attempt to play a cracked or deformed disc, or a disc which has been mended using an adhesive agent, etc. Also do not use an analog record spray or static prevention agent for these will crack the laserdisc surface.

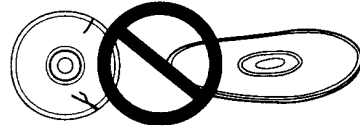

Care of disc

To maintain high video and audio quality, clean the disc if it gets dirty clean by wiping the disc surface with a soft cloth. When wiping, be sure to move the cloth in straight directions from the center of the disc toward the outer edge. Do not wipe in a circular direction like you do with analog records.

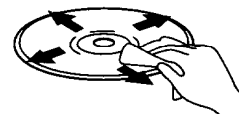

Wipe along the radii.

- Do not use an analog record cleaner, benzine, thinner or static prevention agent.

Storage

After playback, be sure to take out the disc from the player, put the disc in the jacket or case and store it vertically. To prevent the discs from warping, do not store jackets or cases at an angle or stack them horizontally. Also do not store them in a place subject to direct sunlight or under high temperature and humidity. Sometimes reduce the warp or other deformation.

GLOSSARY

LD terms

Chapter number

Just like the numbers assigned to chapters of a book, the LD disc is divided into several chapters and each of them is assigned a chapter number. If the chapter numbers are recorded on the disc, it is possible to perform operations such as the chapter search which quickly searches the desired chapter.

- Some LD discs do not contain recorded chapter numbers.

Frame number

A frame number is assigned to every frame on a CAV disc. This makes possible operations such as the frame search which searches desired images based on their frame numbers.

Time number

This refers to the elapsed playing time from the beginning of the disc that is recorded on CLV discs as well as on CAV discs with a TOC*1. This allows operations such as the time number search which searches desired images based on their time numbers.

CDV/CD terms

Track number

The CDV or CD disc is divided into several tracks and each of them is assigned a track number. With the CDV disc, the track numbers are recorded across the audio and video parts. This allows operations such as the track search which quickly searches the desired track.

TOC (*1)

CD and CDV discs contain non-audio information called TOC the (Table Of Contents) at the beginning of the disc. As this name implies, the TOC contains information on the number of tracks and their playing time just like the table of contents of a book.

- Some LD discs are not provided with a TOC section.
- The LD with TOC and the CDV belong to the same category of "optical video disc systems with digital audio".

CD video system

The CD video system is the unified name given to "optical video disc systems with digital audio".

The systems belonging to this category include;

- CDV disc (CD VIDEO, CDV)
- LD with subcode and digital audio
- CD/CDV compatible player
- CD/CDV/LD compatible player



LD (LaserDisc)

LaserDiscs include a standard play disc (CAV) and an extended play disc (CLV) depending on the signal recording formats.

CAV

[Standard Play/CAV] or simply [Standard Play] is indicated on the jacket or label of the disc.

CLV

[Extended Play/CLV] or simply [Extended Play] is indicated on the jacket or label of the disc.

LaserDisc with digital audio

This type of disc contains the recording of a digital audio signal in addition to an analog audio signal. It allows you to enjoy the high-quality video of an LD and digital sound at the same time.



Multi-audio disc with digital audio

This type of disc contains different audio information in digital audio and analog audio.



The digital and analog audio can be switched over to enjoy different audio information.

CDV (Compact Disc with Video)

- This CD contains the video part. Among the 25-minute playing time of the CDV, 20 minutes contain a similar digital audio to an ordinary CD (audio part) and the remaining 5 minutes contain a video plus digital audio (video part).

CONNECTIONS

Connection with a TV set equipped with Video/Audio inputs

Connection method (Be sure to plug the cords securely deep into the connectors.)

- ① Connect the VIDEO OUT jack of the player to the video input jack of a TV (or a TV monitor).
 - If the TV set has an S VIDEO input jack, connect it using an S VIDEO cable which is available in audio/video stores.
For use of the S VIDEO cable, also read the operating instructions of the TV,
- ② Connect the AUDIO OUT jacks of the player to the audio input jacks of the TV.
- ③ Finally plug the accessory power cord to the AC IN jack and a house hold power outlet (which should permanently be supplied with power).
 - Also read the instruction manual of the TV.

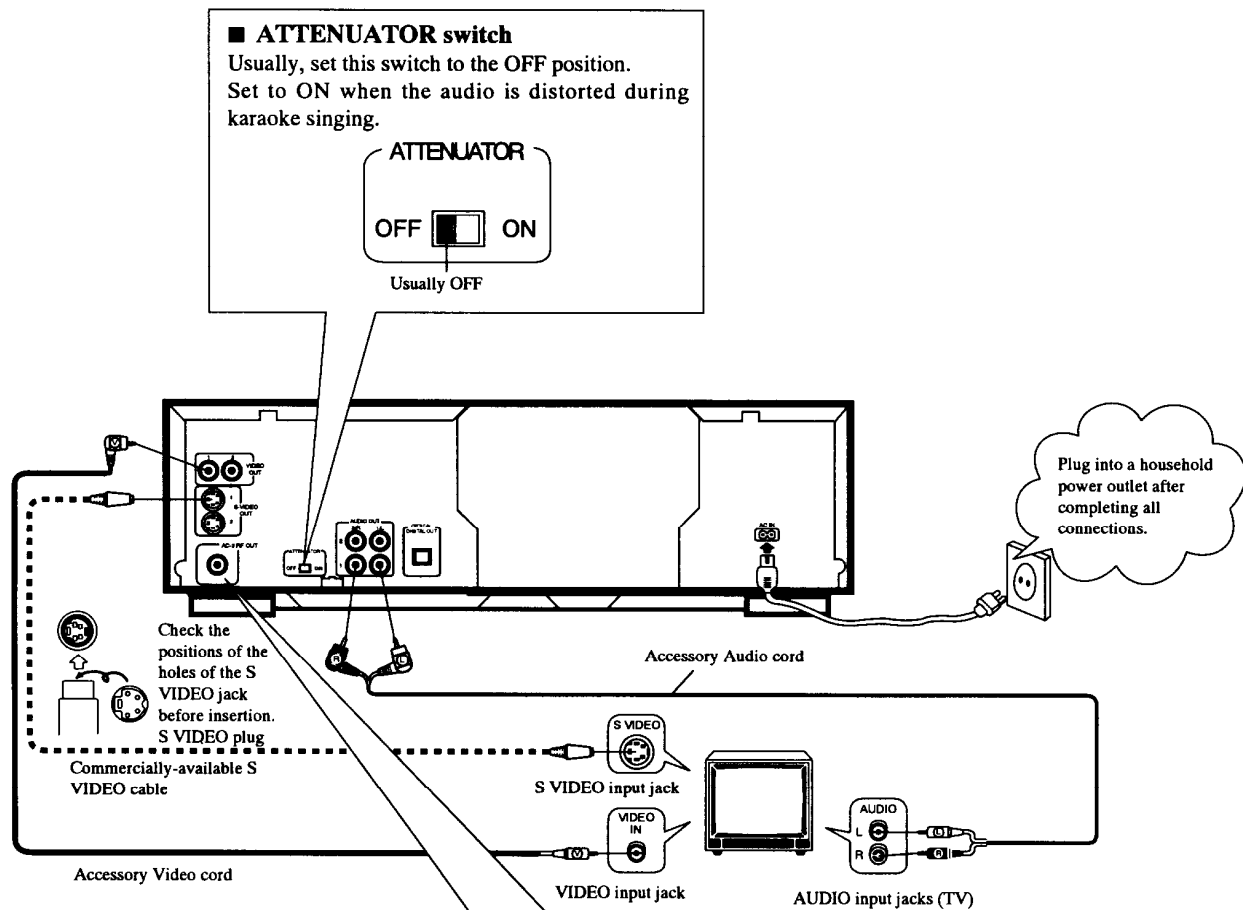

AC-3 RF OUT terminal:

This terminal is intended for use with Dolby* AC-3 components (*1) planned for future release. With this terminal, you will be able to connect an AC-3 RF input of amplifiers and surround processors, and playback Laser Discs formatted with Dolby AC-3 (*2).

(*1) Indicated with  (For hardware)

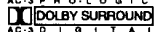
(*2) Indicated with  (For software)

- You cannot playback currently available laser discs, laser disc players, AV amplifiers, etc., with this terminal.
- Do not connect this terminals to the audio input terminal of a normal stereo or AV amplifiers.



* "Dolby", "AC-3" and the double-D symbol are trademarks of Dolby Laboratories Licensing Corporation.

Connection of an additional stereo amplifier

This connection scheme shows how to connect the audio output to a stereo amplifier while the video output is connected to a TV using the scheme shown on page 8. To reproduce the audio of a Compact Disc or an LaserDisc with improved quality, it is recommended to connect the player to a stereo amplifier.

Connect the AUDIO OUT jacks to the input jacks labeled LD, CD or AUX, etc. (Never connect to the PHONO input jacks.)

- Also read the operating instructions of your stereo amplifier.

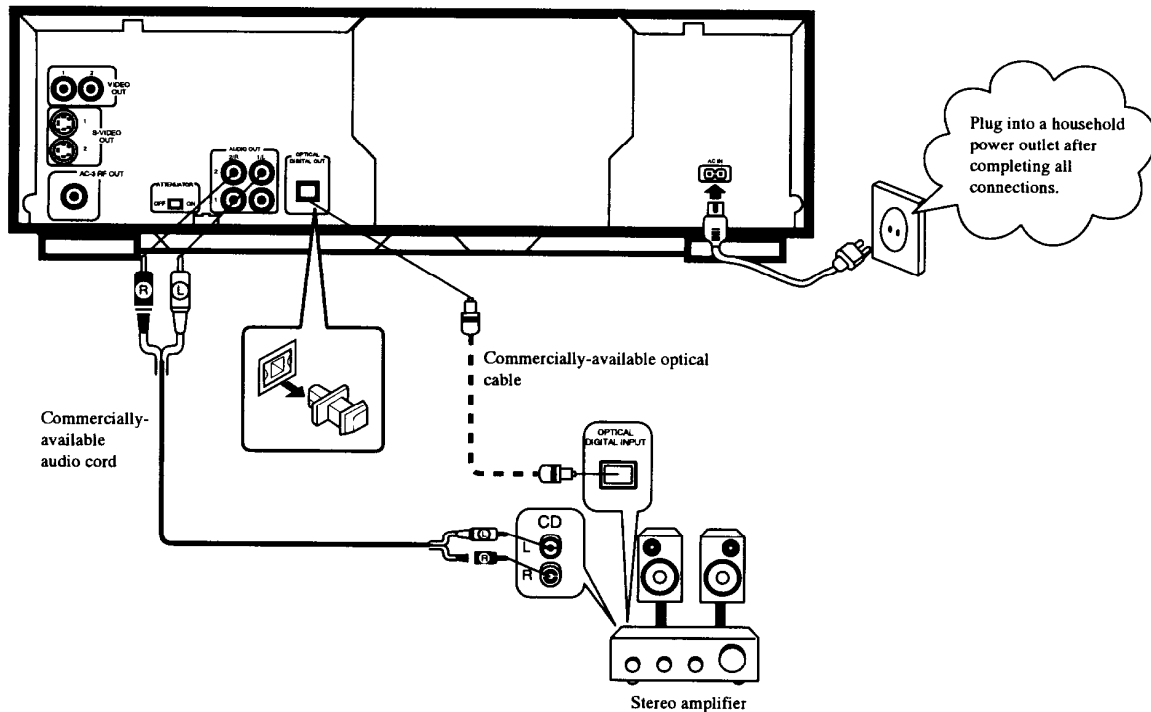

Connecting to the digital jack

- This unit can be connected to an amplifier equipped with an optical digital jack.
- The optical fiber cable is not supplied with this unit. Use a commercially available optical cable for the digital jack connection.

■ When using the OPTICAL DIGITAL OUT jack:

1. Remove the protective dust cap from this unit's OPTICAL DIGITAL OUT jack.
2. Use an optical fiber cable to connect OPTICAL DIGITAL OUT jack of this unit to the optical digital input jack of the amplifier.
 - Align the plug of the optical fiber cable with the optical digital jack and fully insert the plug to make a secure connection.

NOTES:

- When making optical digital connections, this player can only be connected to an amplifier which uses the same type of optical transmissions/reception module.
- Fully insert the optical fiber cable plugs all the way into the jacks.
- Be careful not to fold or crimp the cable. When coiling an optical fiber cable for storage, make sure the diameter of the coil is 15 cm or larger.
- Use an optical fiber cable with a length of 3 m or less.
- Protect the optical fiber cable plugs from scratches and dust.
- When the unit is not connected using an optical fiber cable, be sure to keep the protective dust cap plugged into the optical digital output jack at all time.

NAMES OF PARTS

Front Panel

P. indicates the page where the control is explained.

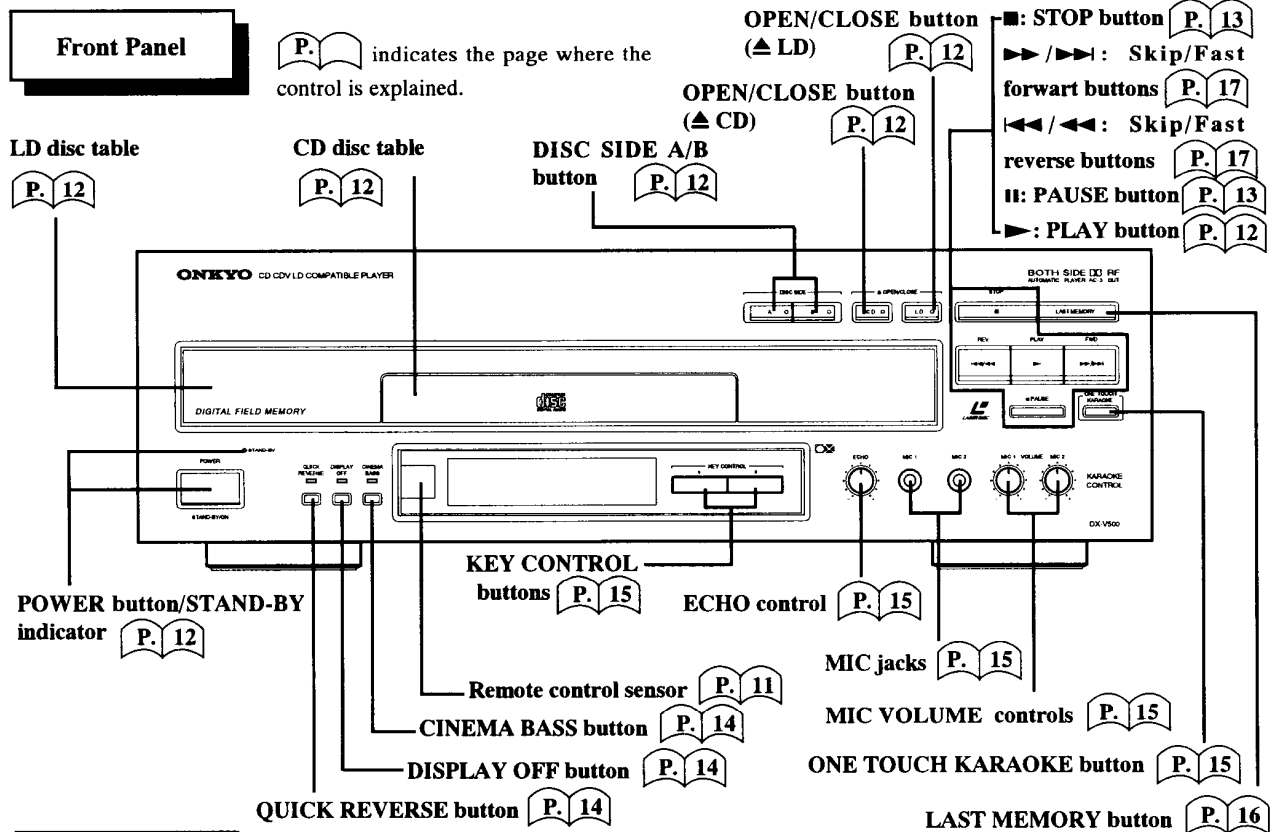

Display window

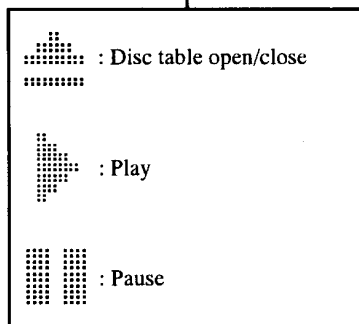
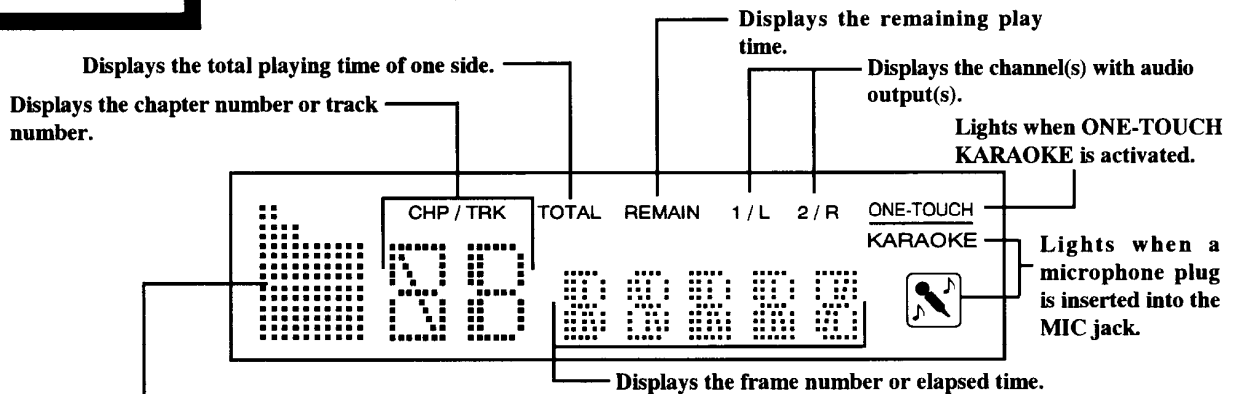

● Displays the functions being operated, etc.

OPEN	: Disc table being opened	AL-RPT	: Double-side repeat playback
CLOSE	: Disc table being closed	S-RPT	: Single-side repeat playback
PLAY	: Start of playback	P-RPT	: Program repeat playback
END	: End of LD	R-RPT	: Random repeat playback
INTRO	: Intro Scan	-OFF-	: Switching power OFF
HILIT	: Highlight Scan	LD	: LaserDisc
RDM	: Random playback	CD	: Compact Disc
PGM	: Programmed playback	CDV	: Compact Disc with Video
RPT	: 1-chapter (1-track) repeat playback	NO DISC	: Disc not present

Remote Control Unit

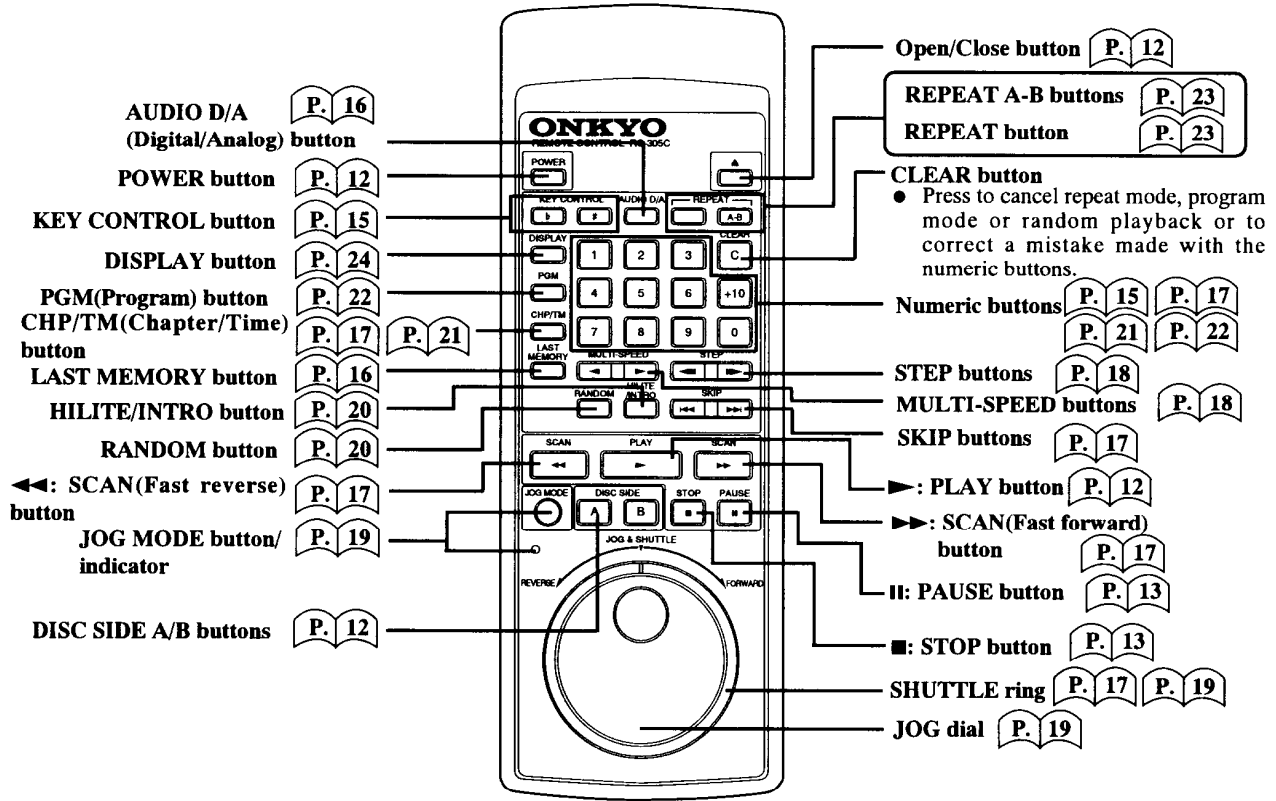

Operation of the remote control unit

Point the remote control unit toward the remote control sensor on the front panel. The distance between the player and remote control unit should be less than 7 meters and the operating angle should be within 30 degrees to the left and right with respect to the remote control sensor.

- To prevent a malfunction, avoid the entry of strong light, such as direct sunlight and fluorescent light, into the remote control sensor.

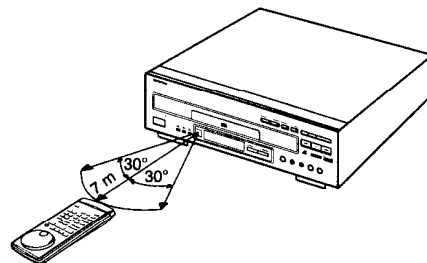

BASIC OPERATION (PLAYBACK OF A DISC)

- For the connections, refer to pages 8 and 9.

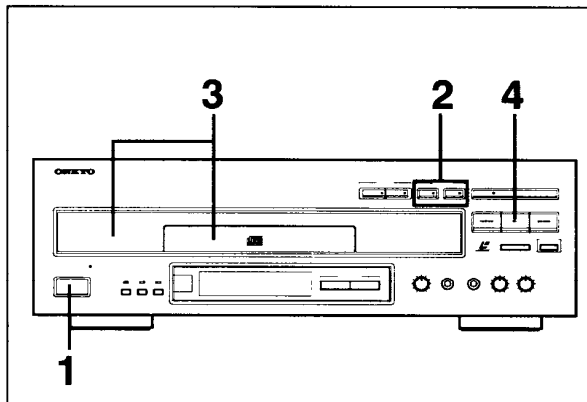

The buttons with the same name on the front panel and remote control unit have the same functions.

- The STAND-BY indicator is lit while the power is OFF.

1. Press POWER.

Set the TV to the function (input) to which the player is connected.

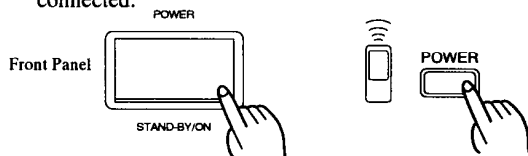

2. Press appropriate OPEN/CLOSE to open the disc table.

To play an LD

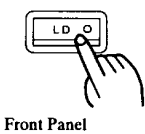

To play a CD

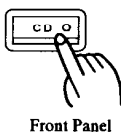

After using a CD, the CD tray opens when you press ▲ on the remote control unit. To playback an LD, use OPEN/CLOSE on the front panel.

3. Place a disc on the disc table.

To place an LD

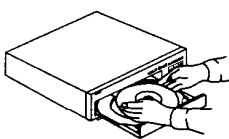

To place a CD

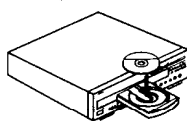

- Place only one disc, LD or CD, at a time.

4. Press ►.

- Playback of the CDV starts with the video part.

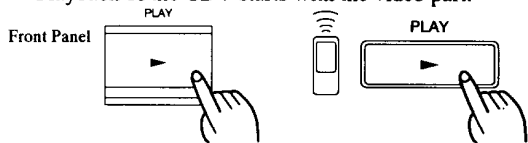

Operations marked with [] are made from the remote control unit.

Disc placing position

The CD/CDV or single-sided LD should be placed with the label side facing up and the double-sided LD should be placed so that the label of the side to be played faces up. Place any disc correctly along the guide groove provided for each size.

LD disc table :

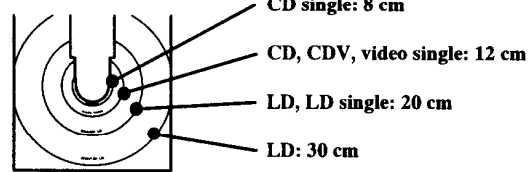

CD disc table :

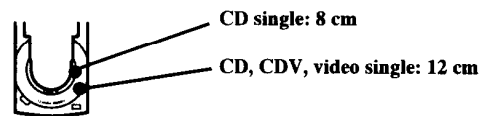

Caution in placing a disc

Be careful not to deviate a disc from the guide groove on the disc table, for this will make proper playback impossible and could cause a malfunction such as disc damage.

For safety!

- Be careful not to catch your finger in the disc table when it draws in. Also take care to prevent a small child from opening the disc table cover and inserting their hand inside the player to prevent injury.
- Do not place an object other than a disc on the disc table.

Convenient feature (Auto power-ON function)

- When the power is OFF, pressing OPEN/CLOSE turns on the power automatically and opens the disc table.
- When you have turned the power OFF with a disc left inside the player, simply press ► on the front panel; the power turns ON automatically and playback of the disc starts.
- The above features cannot be operated with the remote control unit.

Playback by specifying side A or B

In this description, side A refers to the surface facing up when the disc is placed on the disc table, and side B refers to the other side.

Note that they are not always the same as disc sides A and B as recorded on the disc.

It is recommended to place a disc so that the side labeled "SIDE A" faces upward.

To play side A only: When the disc with the side labeled "SIDE A" is facing up, press DISC SIDE A without pressing ►. The player will stop after having played side A.

To play side B only; Press DISC SIDE B without pressing ►. The player will stop after having played side B.

If the disc has been placed with the recorded "SIDE B" facing up, DISC SIDE A plays side B and DISC SIDE B plays side A.

Display when the disc side is switched

- Turning from side A to side B
- Turning from side B to side A

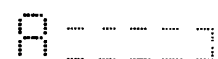
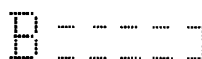

BASIC OPERATION (PLAYBACK OF A DISC)

To stop playback and take out the disc

1. Press OPEN/CLOSE.

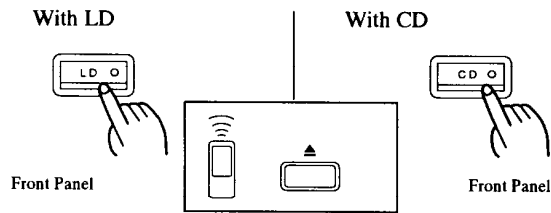

2. Take out the disc.

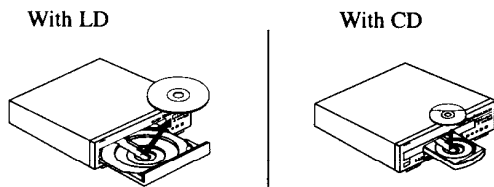

3. Press OPEN/CLOSE to close the disc table.

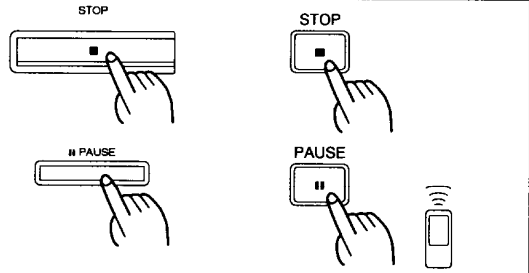
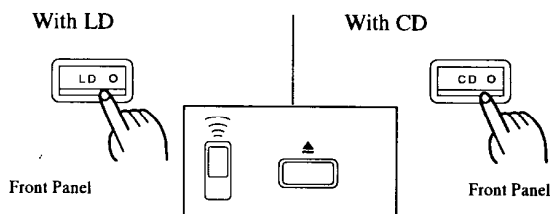

To stop playback (■)

Press ■.

To pause playback temporarily (||)

Press ||. The audio and video disappear and the || indicator lights on the display. Pressing || again resumes playback from the position where it was paused.

- A still image is displayed during pause with a LD.
- Leaving the player in pause mode for a long period of time may shorten the life of the motor. Therefore, the player automatically enters stop mode when pause mode has lasted for about 20 minutes. (Pause timer)

MOVIE DISC ENTERTAINMENT

The on-screen display can be defeated to enhance the ambience of movie entertainment. In addition, the Quick-Reverse function which allows to reduce the time required before starting playback or changing disc side and the Cinema Bass function which allows to select the audio matching the ambience of each movie are also provided.

To turn off the display

Press DISPLAY OFF.

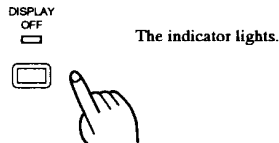

- The display window as well as the on-screen display turns off. However, when a button on the player or remote control unit is pressed, the operation mode is displayed for about 1.5 seconds.
- The TV screen color while the disc is stopped changes from a blue background to a black background.

NOTE :

When DISPLAY OFF is pressed, the display window turns off even while the power is ON. The display OFF state is held in memory even after the power is switched off so the display window is off when the power is switched on later. To turn on the display window, press DISPLAY OFF again.

To reduce the playback start time and turn time (QUICK-REVERSE)

The indicator lights when the quick-reverse function is on.

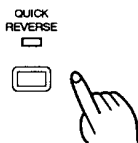

- Press QUICK REVERSE to turn this function off.
- When the quick-reverse is on, the TOC recorded on the disc is not read so the time required before starting playback or turning the disc can be reduced. As a result, even when the LD being played contains TOC information, **the random playback, total time display, remaining time display and the elapsed time display of CAV (standard play) disc will not function.**

NOTES :

- When the power cord is plugged into a household power outlet and the power of the player is switched on, the quick-reverse is automatically turned on and the indicator lights.
- The quick-reverse is turned off automatically when a CD is inside the player. If an LD is placed in it, the previous state is recalled from the memory and the quick-reverse is turned on again.
- The quick-reverse on or off state is held in memory even after the power is switched off so the same state is recalled when the power is switched on later.

To select the audio that matches the ambience of the movie (CINEMA BASS)

The indicator lights when the cinema bass function is on.

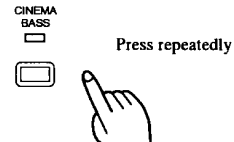

The bass sound can be enhanced every time CINEMA BASS is pressed. Set the button to the desired position according to the atmosphere of the movie you watch.

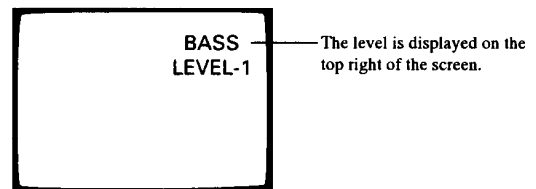
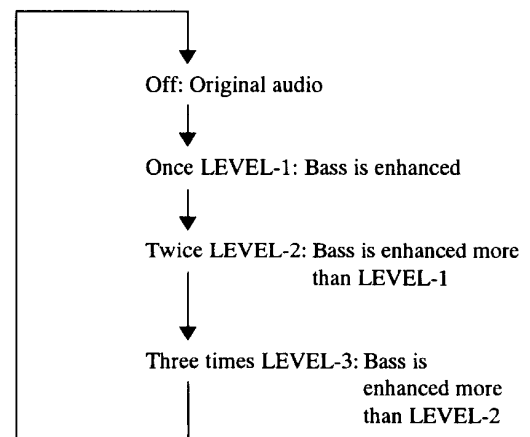

NOTES:

- Turning on Cinema Bass may distort the dialog portion of a sound track when used with certain discs or system configurations. If this occurs, either turn down the Cinema Bass level or turn Cinema Bass off.
- The Cinema Bass is turned off automatically when a CD is inside the player. If an LD is placed in it, the previous state is recalled from the memory and the cinema bass is turned on again.
- The cinema bass on or off state is held in memory even after the power is switched off so the same state is recalled when the power is switched on later.
- The Cinema Bass function is switched off automatically when the microphone is plugged in. The Cinema Bass is switched back to on as soon as the microphone is unplugged.
- The Cinema Bass function is switched off automatically when One-Touch Karaoke is switched on. In this case, return to the Cinema Bass does not occur.

SINGING ALONG WITH KARAOKE ENTERTAINMENT

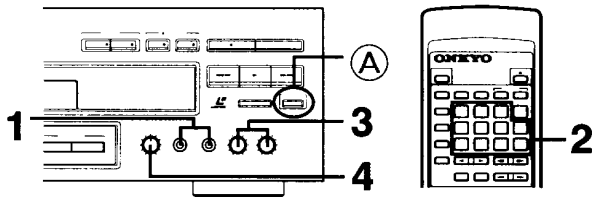

1. Insert the microphone plug(s) into the MIC jack(s).

- The KARAOKE indicator lights on the display.

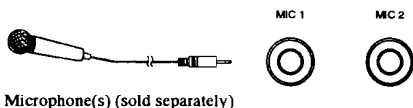

2. Select music with the numeric buttons on the remote control unit.

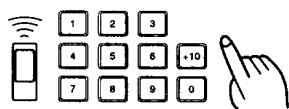

To select No. 10 or beyond:
Use the +10 and 0 buttons.
(Examples) 17: [+10], [7]
20: [+10], [+10], [0]

3. Adjust the microphone volume with the MIC VOLUME control(s). Also adjust the listening level of the TV set.

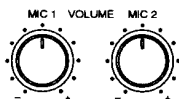

4. Adjust the echo with the ECHO control.



- Now start singing!
- When the selected music has been played, the player enters pause mode. To continue karaoke singing, select another song with the numeric buttons.

(A): To mute the voice(s) of the singer(s) from a disc :
Press ONE TOUCH KARAOKE.

- The ONE TOUCH KARAOKE indicator will light on the display.

Stereo audio disc :

- The voice(s) of the singer(s) is/are reduced so that you can practice karaoke singing.

Multiplexed audio disc :

- Karaoke play starts.



CD, CDV		The volume of the singer's voice (vocal) is reduced.
LD	Multiplexed audio disc	The karaoke music recorded in the L (Left) channel is played. (This is monaural audio.)
	Stereo audio disc	When an ordinary stereo disc is played, the singer's voice (vocal) is reduced.
	Digital multiplexed audio disc (Digital audio : Stereo) (Analog audio : Multiplexed)	The karaoke music is played in stereo. (However, if the analog audio is selected with AUDIO D/A, the effect becomes the same as the multiplexed audio disc described above.)

NOTES :

- In case the audio is distorted, set the ATTENUATOR switch on the rear panel to ON. (P. 8)
- In case playback is started with ►, the player does not pause after having played the music.
- If you do not want the player to pause, press and hold ■ on the front panel for more than 2 seconds until the KARAOKE indicator turns off.
- The pause after playback also occurs after programmed playback (P. 22) and random playback (P. 20). If you do not want the player to pause after programmed or random playback, press and hold ► for more than 2 seconds during programmed or random playback.
- During the operation of the ONE TOUCH KARAOKE function, it is not possible to switch the L (Left) and R (Right) channels with AUDIO D/A.
- The voice(s) of the singer(s) may not be reduced with certain discs, even if you press ONE TOUCH KARAOKE.

To set a desired pitch (key control function)

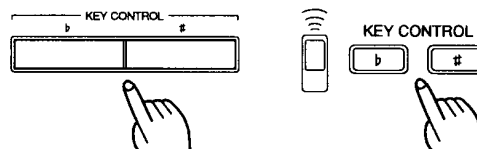

:Pitch is heightened each time this button is pressed (up to 5 steps from normal).

b :Pitch is lowered each time this button is pressed (down to 5 steps from normal).

- The current pitch position is shown by the lit indicator on the TV screen.

- The key control is possible only while a microphone is plugged in.

The karaoke audio varies as shown below according to the type of disc.

APPLIED OPERATIONS

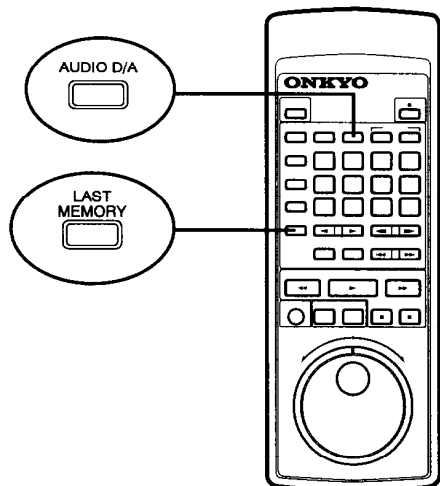

To play an LD from the position where playback was last stopped

If **■** or **POWER** is pressed during playback, and playback has not reached the middle of the disc, it is possible to restart playback from the position where it was stopped.

When playback of an LD is stopped by pressing **■** or **POWER**, the address where the playback is stopped is stored in memory and, provided that the disc is left in the LD disc table, the stored address is held in memory even after the power is switched off. When you switch the power on and press **LAST MEMORY**, playback starts from the position where it was last stopped.



To start playback directly from the position where it was stopped:



Position slightly before



Position where playback was stopped

Press **LAST MEMORY** once. Playback starts from the position slightly before the position where it was last stopped.

To start playback after reviewing the plot from the beginning to the position where it was last stopped:

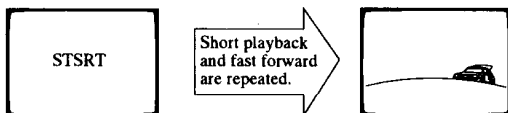

Press **LAST MEMORY** consecutively twice. A short period of playback and fast forward operations are repeated from the beginning of the disc until slightly before the position where playback was last stopped, and normal playback starts from there. By pressing **LAST MEMORY** again during the fast forward operation, playback can be started directly from slightly before the position where it was last stopped.

NOTES :

- The last memory playback function is available only with LDs. It is not available with CD and CDV discs.
- If playback was last stopped in the middle of side B of a double-sided disc, the last-memory playback starts from side B.
- When **▶** is pressed to start playback after it has been stopped with **■**, playback starts from the beginning of the disc.
- Be sure to leave the disc inside the player. The last-memory playback is not possible once the disc has been taken out of the player.
- Be sure to plug the AC power cord into a power outlet to which power is supplied permanently.

Audio switching

Every time **AUDIO D/A** is pressed during playback, the played audio is switched. This makes it possible to;

- listen to the analog audio of a disc with digital audio;
- listen to only one of the two channels of a stereo disc;
- select the audio to be played from multiplexed audio disc.

LD

LD with digital audio

It is possible to switch between the digital and analog audio and between the L (Left) and R (Right) channels of stereo audio.

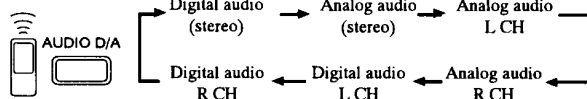

- In a case of a disc recorded with Dolby AC-3 signal, only the left channel signal is heard in monaural mode when an analog audio is selected.

LD with analog audio

- Disc containing CX auto ON (OFF) switching codes

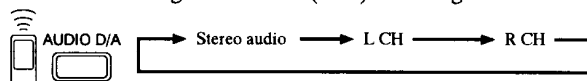

- Disc without CX auto ON (OFF) switching codes

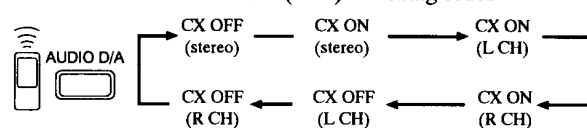

CD and CDV

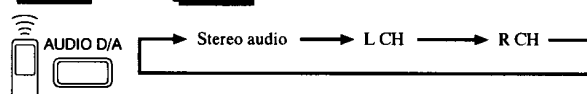

LD with \square mark

\square functions on the analog audio of LD.

With an LD carrying the \square mark, audio can be played with reduced noise using the CX noise reduction system.

Some of the discs carrying the \square mark do not contain the codes for automatic ON/OFF switching of the CX system. With such discs, turn CX ON by pressing **AUDIO D/A** on the remote control unit.

- \square is a trademark of CBS. This player conforms to the extended specifications of CX.

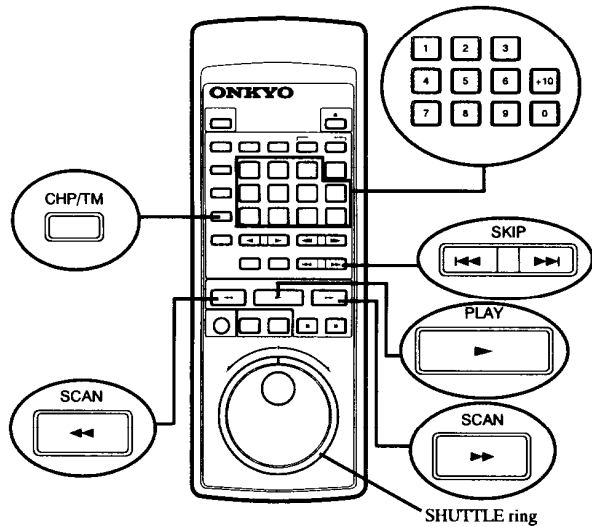

Scan (Manual Search)--Search using fast forward or fast reverse

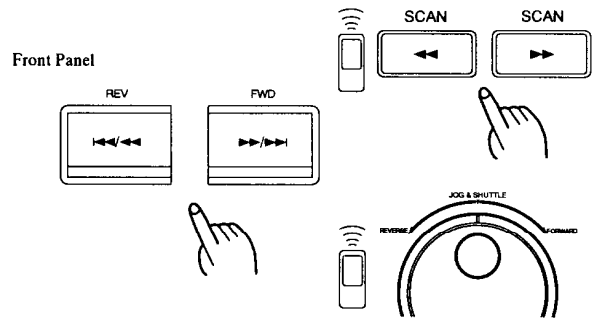

Press and hold **▶▶** or **◀◀** during playback to start a slow scan of the image. The scan speed increases to high speed if the button is held depressed for more than 4 seconds after starting the scan. However, the high speed scan does not function during playback of a CDV (video part).

Searching the beginning of a chapter/track

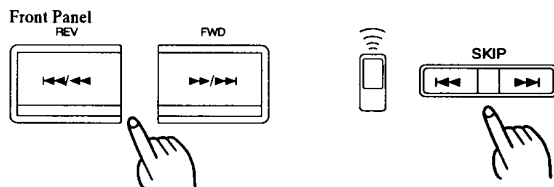

To skip to the beginning of a chapter/track,
▶▶ :Press to advance to the next chapter or track.
◀◀ :Press to return to the beginning of the chapter or track being played.
 • Press repeatedly to move further to other chapters/tracks.

Searching the desired scene directly

Specify the chapter number or track number.
Example: Playing an LD from the beginning of chapter No. 3

<Direct search>
 Press numeric button "3".

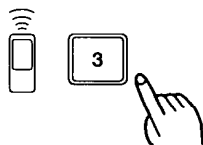

To select chapter No. 10 or beyond:
 Use the +10 and 0 buttons.

(Examples) 17 : **+10**, **7**
 30 : **+10**, **+10**, **+10**, **0**

<Normal search>

It is also possible to specify a chapter or track number with CHP/TM as shown below.

(Examples)
 17 : **CHP/TM**, **CHP/TM**, **1**, **7**, **PLAY**
 30 : **CHP/TM**, **CHP/TM**, **3**, **0**, **PLAY**

To stop search in the middle:
 Press CLEAR during search.

NOTE :
 Some discs do not contain the chapter numbers. Direct search and normal search are not available with these discs.

Rotate the SHUTTLE ring on the remote control unit clockwise during playback fast forward the video. Rotating the ring counterclockwise to fast reverses the video. Normal-speed playback resumes when the ring is released.

- The speed varies depending on the angle the SHUTTLE ring is rotated. From slow speed in the beginning to higher speeds when the ring is rotated further, the speed varies in 4 steps. **P.19**

When a disc is scanned until the beginning:
 Normal playback will start.

When a disc is scanned until the end:
 With an LD, the player will pause at the end of the disc.
 With the video part of a CDV, the audio part will be searched.

During fast forward or fast reverse, the audio is:
 Not heard.

NOTES:

Note on CAV (standard play disc):
 During scanning, noise may appear on the screen. This is not a malfunction.

Note on CLV (extended play disc):
 • The scan speed is different between inner chapters and outer chapters depending on the positions they are recorded on the disc.

APPLIED OPERATIONS

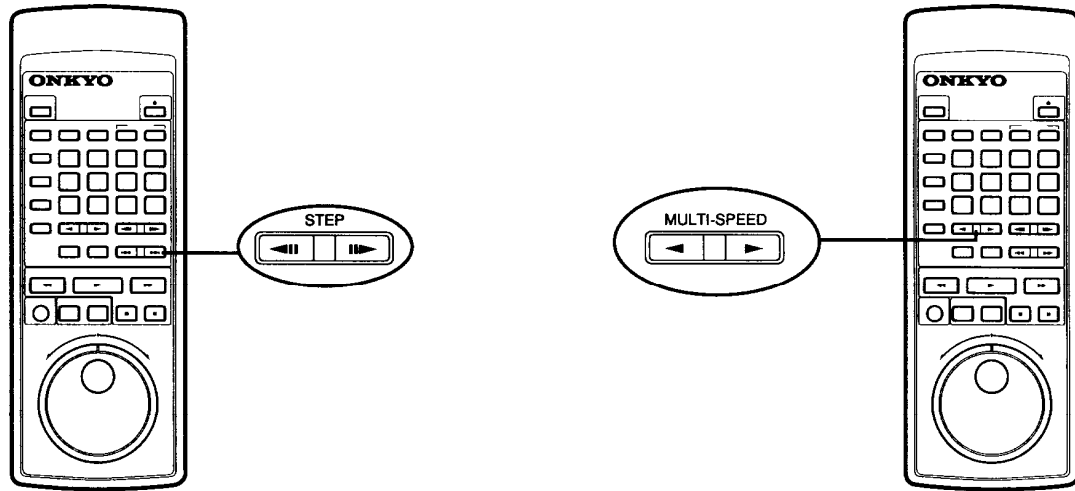

Still image/frame advance (LD and CDV video parts only)

Freezing an image – Still image

Press either ◀◻◻ or ◻◻▶ to display a still image.

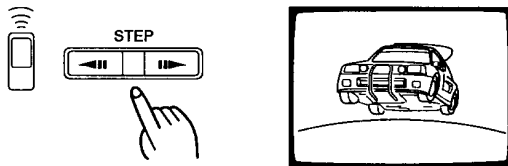

- A still image can also be displayed with ◻◻.

Displaying image frame by frame – Frame advance

While a still image is displayed, press either ◀◻◻ or ◻◻▶.

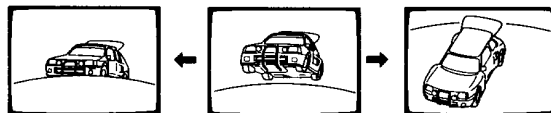

Each press reverses one frame.

Each press forwards one frame.



Press and hold for continuous frame advance.

Multi-speed playback by varying the playback speed and direction (LD and CDV video parts only)

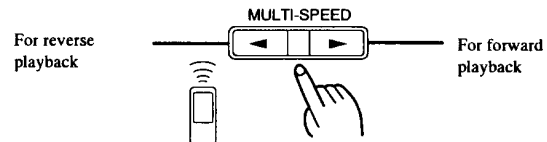

The first press of either MULTI SPEED ◀ or ▶ changes the playback speed to 1/8 the normal speed. Further pressing of the same button changes the playback speed as shown below.

Display	Speed
1/8	1/8 the normal speed
1/2	Half the normal speed
x2	Twice the normal speed
1/2	Half the normal speed
1/8	1/8 the normal speed
1/30	1/30 the normal speed

NOTES :

- Press ▶ to return to normal playback.
- The audio is not heard during still image, frame advance and multi-speed playback.

In case a still image appears automatically during playback:

Some discs contain special recorded signals called picture stop codes. When playing such a disc, you can continue playback without displaying still images on the positions where picture stop codes are recorded by pressing and holding ▶ on the front panel for more than 2 seconds to activate the picture stop cancel function. On-screen display "PSC ON" is displayed for a few seconds when this function is activated. To cancel this function, press and hold ▶ for more than 2 seconds until "PSC OFF" is displayed on the screen for a few seconds.

Searching a scene using special playback which can vary the playback speed and direction with one-touch operation (LD and CDV video parts only)

Use the SHUTTLE ring and JOG dial.

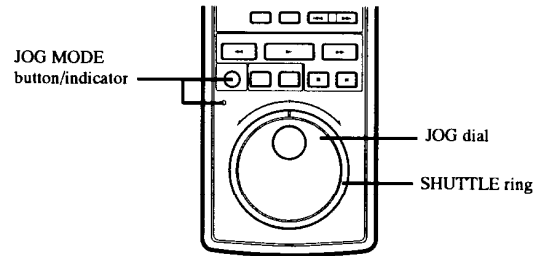

Press JOG MODE. The JOG MODE indicator lights. Frame advance, 1/2-speed, normal-speed and x2-speed playback in both forward and reverse directions are possible according to the direction and angle in which the JOG dial is rotated.

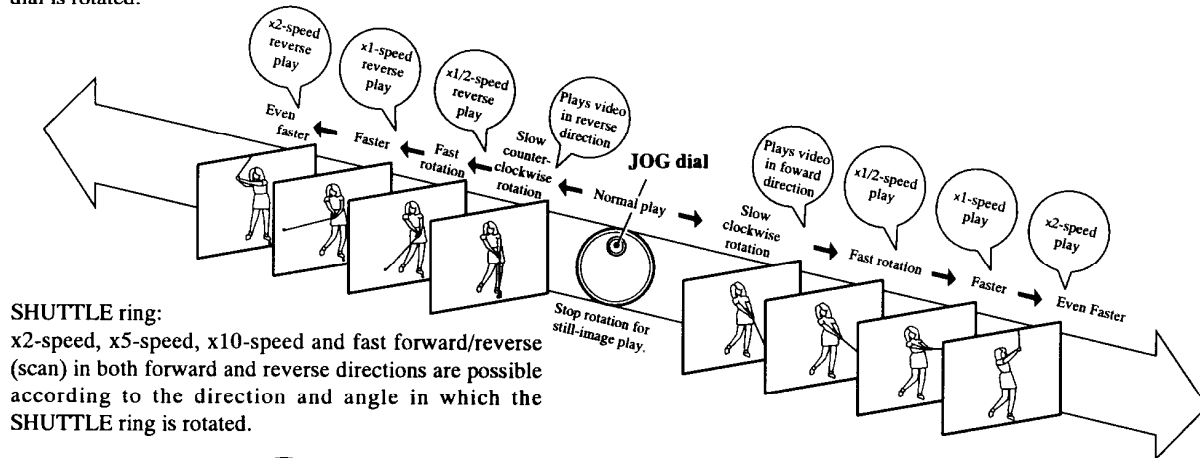

SHUTTLE ring: x2-speed, x5-speed, x10-speed and fast forward/reverse (scan) in both forward and reverse directions are possible according to the direction and angle in which the SHUTTLE ring is rotated.

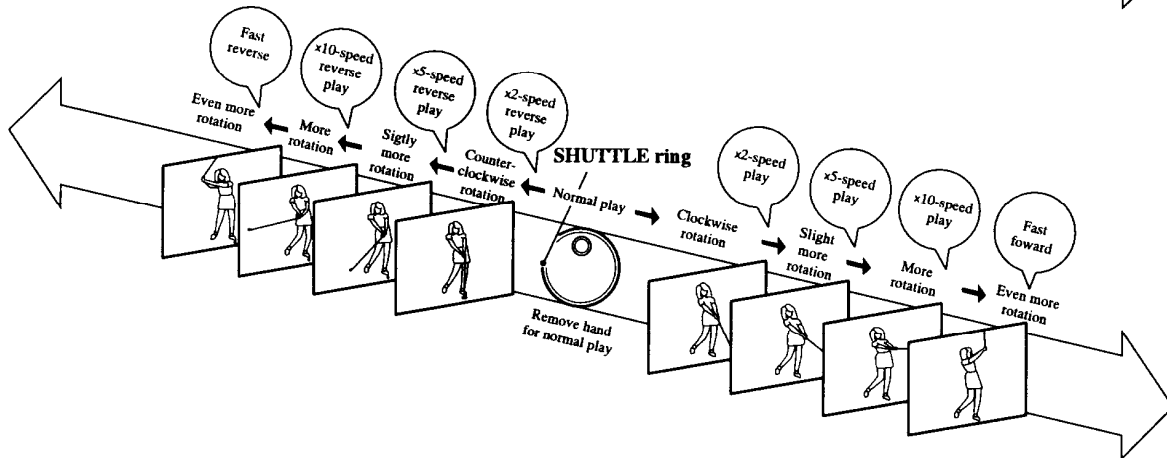

Audio is not output during special playback using the JOG dial or SHUTTLE ring. (Audio is not output even at normal speed.)

With special playback of the video part of a CDV using the SHUTTLE ring:

Up to x10-speed playback is possible. Fast forwarding or fast reversing at a with higher speed are not possible.

To return to normal playback after JOG dial operation:
Press ►.

Set JOG MODE on the remote control unit to off when the JOG dial is not used:

JOG MODE turns off automatically in about 5 minutes after the JOG dial is last operated (JOG MODE indicator also goes off). However, to save the batteries in the remote control unit, it is recommended to press JOG MODE to off after completing JOG dial operation.

When a disc has been scanned until the end:

A still image is displayed.

When the video part of a CDV has been scanned until the end, its audio part starts to be searched.

QUICK SCANNING OF DISC CONTENTS

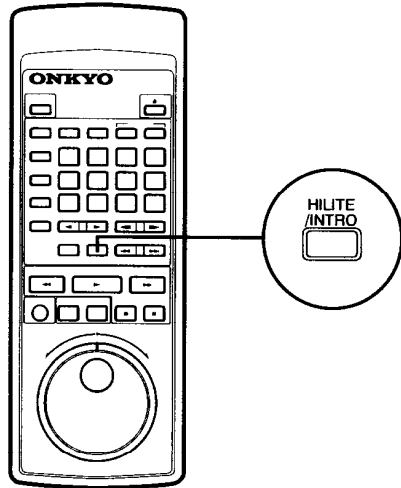

Intro Scan (Available on LD and CDV video parts)

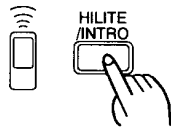

When the button is pressed during playback or in stop mode:
The first 8 seconds of every chapter will be played in order. When ► is pressed, normal playback starts from that position. When the disc has been scanned until the last chapter, normal playback starts from chapter No. 1.

Highlight Scan (Available on CD and CDV audio parts)

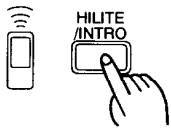

When the button is pressed in stop mode:
Highlight Scan starts, with which on 8-second section starting 1 minute after the beginning of every track, will be played in order.

When the button is pressed during playback:
Assuming that the time elapsed from the beginning of the track being played until the position where the button is pressed is called the Highlight Scan starting period, the 8-second section will be played after this starting period, on every track beginning with track No.1.

NOTES :

- With a CDV, the operation begins with Intro Scan of the video part and continues to Highlight Scan of the audio part.
- Intro Scan is not available with discs which do not contain recorded chapter numbers.
- When a track is shorter than 1 minute or than the set starting period, Highlight Scan of that track starts at the beginning and lasts for 8 seconds. In case a track is shorter than 8 seconds, it will be played entirely from the beginning.

RANDOM PLAYBACK (PLAYBACK IN ORDER SELECTED BY THE PLAYER)

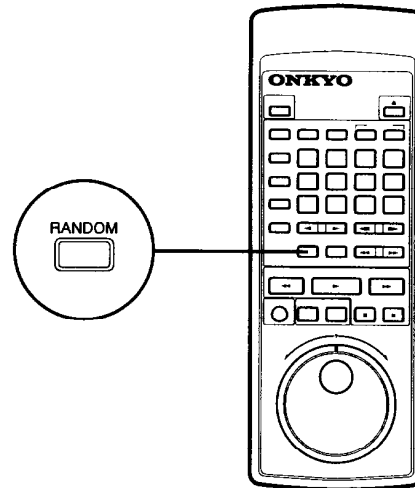

Random playback (CD, CDV and LD with TOC only)

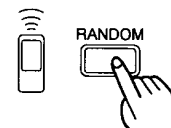

Press RANDOM.

With an LD, first press QUICK REVERSE to turn the quick-reverse off, then press ► and finally press RANDOM.

All chapters/tracks in the disc are played in a random order selected by the player. Random playback stops after all of the chapters/tracks on the disc have been played.

During random playback:

- Pressing ►► plays the next selected track.
- Pressing ◀◀ replays the track being played from the beginning.
- Pressing CLEAR cancels random playback and starts normal playback.
- Pressing RANDOM again restarts random playback with a newly selected order of tracks.

To stop random playback:

Press ■.

NOTES :

- Chapter 0 is not included in random playback.
- Random playback of programmed chapters/tracks is not possible.
- Random playback is not possible with an LD without a TOC. (P. 7)
- While the quick-reverse is on, random playback is not possible even with an LD containing a TOC. In this case, stop playback and turn off the quick-reverse function before starting random playback. (P. 14)

TO SEARCH FOR A DESIRED FRAME

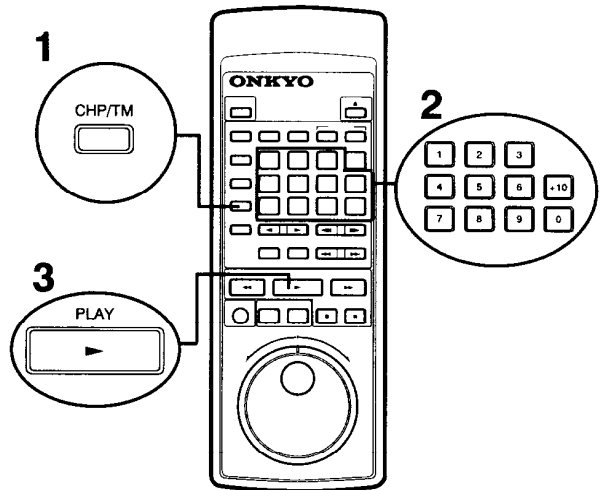
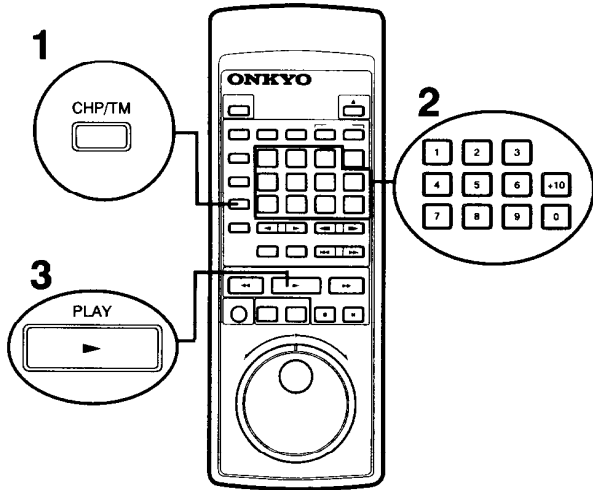

This function is available on LDs only.

With a CAV (standard play) disc, the desired image can be searched by specifying the frame number (refer to P. 7 for definitions).

This function is available on LDs only.

With a CLV (extended play) disc, a desired image can be searched by specifying the time number (refer to P. 7 for definitions).

(Example) To search the image at frame No. 1234:

1. Press CHP/TM during playback.

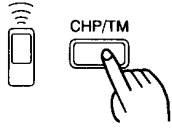

2. Press numeric buttons 1, 2, 3 and 4.

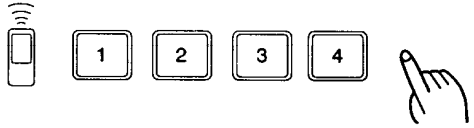

3. Press ►.

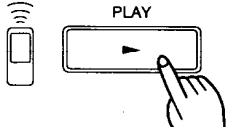

The specified frame is searched and a still image is displayed.

- Press ► again to restart normal playback.

(Example) To search the image at 12 min, 34 sec.:

1. Press CHP/TM during playback.

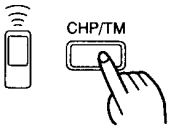

2. Press numeric buttons 1, 2, 3 and 4.

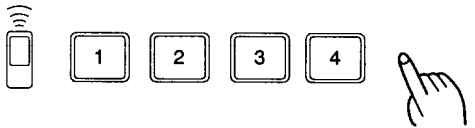

3. Press ►.

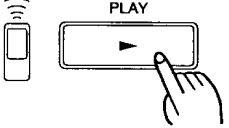

Still image of the specified time is displayed.

- Press ► again to restart normal playback.

NOTES :

- With a disc which does not contain time information in seconds, specify the time in minutes (2 digits).
- If the time number or frame number specified is greater than the last number on the disc, the player pauses at the end of the disc.

PROGRAMMED PLAYBACK (PLAYING CHAPTERS/TRACKS BY CHANGING THEIR ORDER AS REQUIRED)

Desired chapters (LD) or tracks (CDV/CD) can be programmed to be played in a desired order. Up to 24 chapters/tracks can be programmed at a time.

- Programming operation can be made easier by observing the on-screen display or display window during operation.

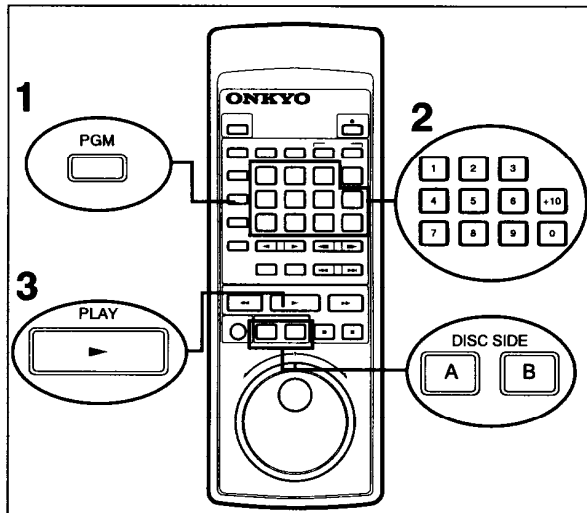

1. Press PGM.

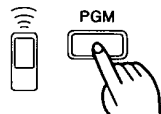

2. Select the chapters or tracks to be programmed.

<With a double-sided LD>

Example : Programming chapter 9 on side B, chapter 7 on side A and then chapter 18 on side B

- ① Select side A or B.

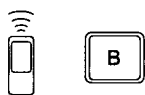

- ② Specify the chapter number.

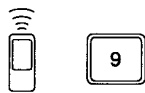

- Program the next chapter by repeating steps ① and ② above.



<With a single-sided LD, CD or CDV>

Example : Programming CD tracks 9, 7, and then 18

- Press numeric buttons 9, 7, +10, and then 8.

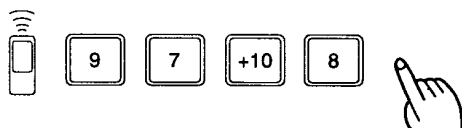

If you press a wrong numeric button :

Press CLEAR, then press the correct numeric button(s).

3. Press ►.

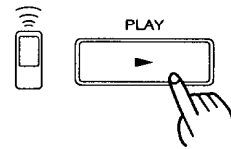

Programmed playback starts after searching the first programmed track/chapter. In the examples above, the programmed playback starts from chapter/track No. 9. When chapter/track Nos. 9, 7, and then 18 have been played, the player enters stop mode.

Programming of pause

Programming pauses together with chapter/track numbers is very convenient for recording the programmed playback.

- In case of recording the programmed playback on two sides of an audio tape, it is recommended to program a pause after the last chapter/track to be recorded on the first side of the tape. This makes it possible to flip the tape while playback is paused and avoid making a recording mistake.
- While programmed playback is paused, it is possible to record a narration or create a non-recorded blank. Pressing II in pause mode resumes programmed playback so that recording can be restarted.
- It is not possible to record a pause as the final step of the program.

Indication of programmed pause

"II" appears on the TV screen and "PA" appears on the display window.

To check the programmed contents

When PGM is pressed during or after programmed playback, the programmed contents can be displayed on the TV screen. Pressing PGM again turns off the display of the programmed contents.

To modify programmed content

To delete a programmed chapter number, track number or pause:

1. Press PGM.
2. Press either ◀◀ or ▶▶ to move ► (the cursor) on the TV screen to the chapter number, track number or pause to be modified.

If you want to replace that content, press the numeric button.

If you want to program a pause, press II.

If you want to clear content, press CLEAR.

3. Press PGM to complete.

If you press ► in place of PGM, programmed playback starts from the first programmed chapter or track.

- It is not possible to replace or clear the chapter or track being played.

To clear the entire program

- Open the disc table.
- Press CLEAR in stop mode.
- When CLEAR is pressed during playback, the programmed playback is canceled and normal playback starts. Pressing CLEAR again also clears the programmed contents.

REPEAT PLAYBACK

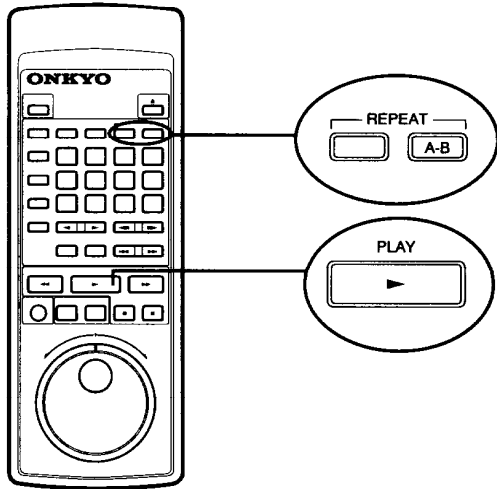

To repeat a chapter/track being played

- Press **REPEAT** once during playback of the chapter or track to be repeated.

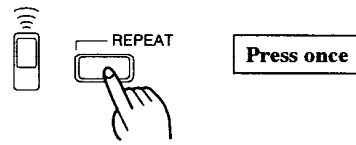

To repeat programmed playback

It is possible to play programmed chapters or tracks repeatedly in the order they were programmed. Press **REPEAT** once during programmed playback.

- For programming, refer to [P. 22](#).

To return to the specified position

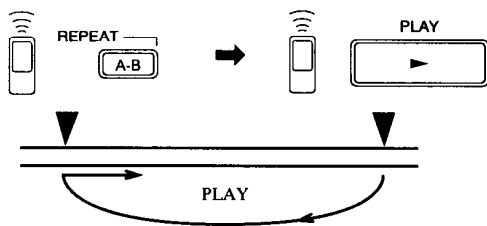

During playback, press **REPEAT A-B** at the desired position.

To return to the specified position, press **▶**.

- Press **CLEAR** if you want to cancel the command.

To repeat random playback

It is possible to play tracks in a randomly selected order repeatedly. Press **REPEAT** once during random playback.

- For random playback, refer to [P. 20](#).

To repeat the entire side of a disc

Press **REPEAT** twice.

- When one side of the disc has played back, the same side is repeated from the beginning.

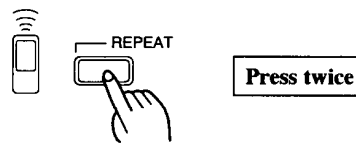

To repeat the desired section repeatedly

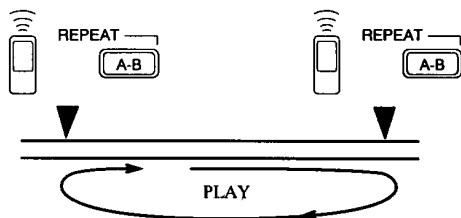

Press **REPEAT A-B** at the beginning of the section to be repeated.

Press **REPEAT A-B** at the end of the section to be repeated.

- The repeat playback above is not possible if the section extends over both the audio and video parts of a CDV. Repeat playback extending over sides A and B of a double-sided LD is also impossible.

To repeat both sides of a disc (double-sided LD only)

Press **REPEAT** 3 times.

- Playback starts with side A and continues on side B. When both sides of the disc have played back, both sides are repeated alternately.

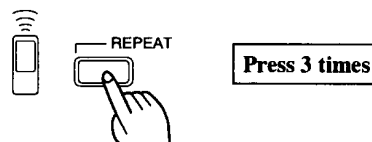

To stop repeat playback :

Press **CLEAR**, or press **REPEAT** so that the REPEAT indicator turns off. The repeat mode is canceled but playback continues as normal playback.

With an LD which does not contain chapter numbers :

It is not possible to repeat a chapter. With such a disc, press **REPEAT** once for one-side repeat playback.

ON-SCREEN DISPLAY

The actual on-screen display is shown below.

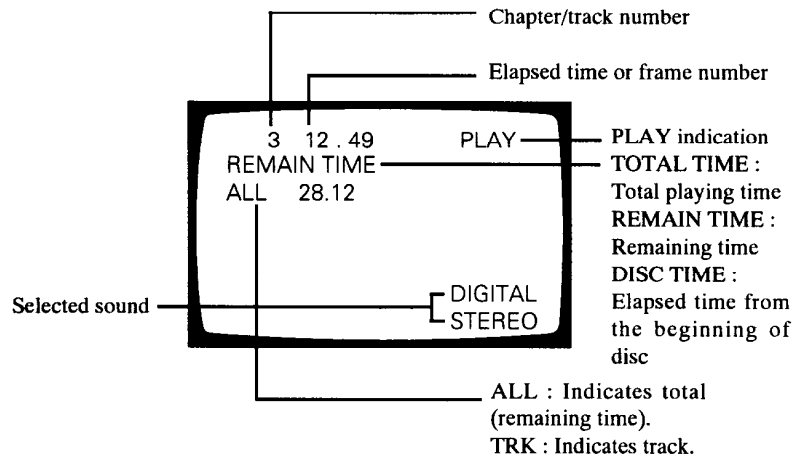
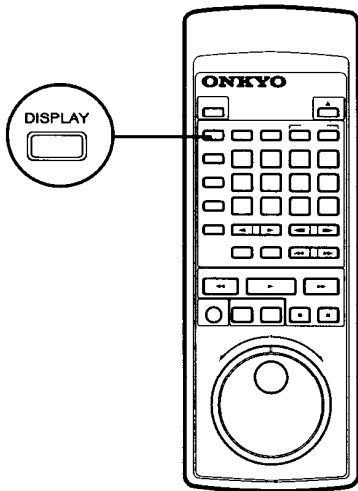

Use DISPLAY on the remote control unit to display information such as the current playback mode, track/chapter number and playing time on the TV screen. Each press of DISPLAY changes the displayed information as follows:

If the on-screen display is left for a long period (about 80 minutes), it turns off automatically. The on-screen display re-appears when any button is pressed.

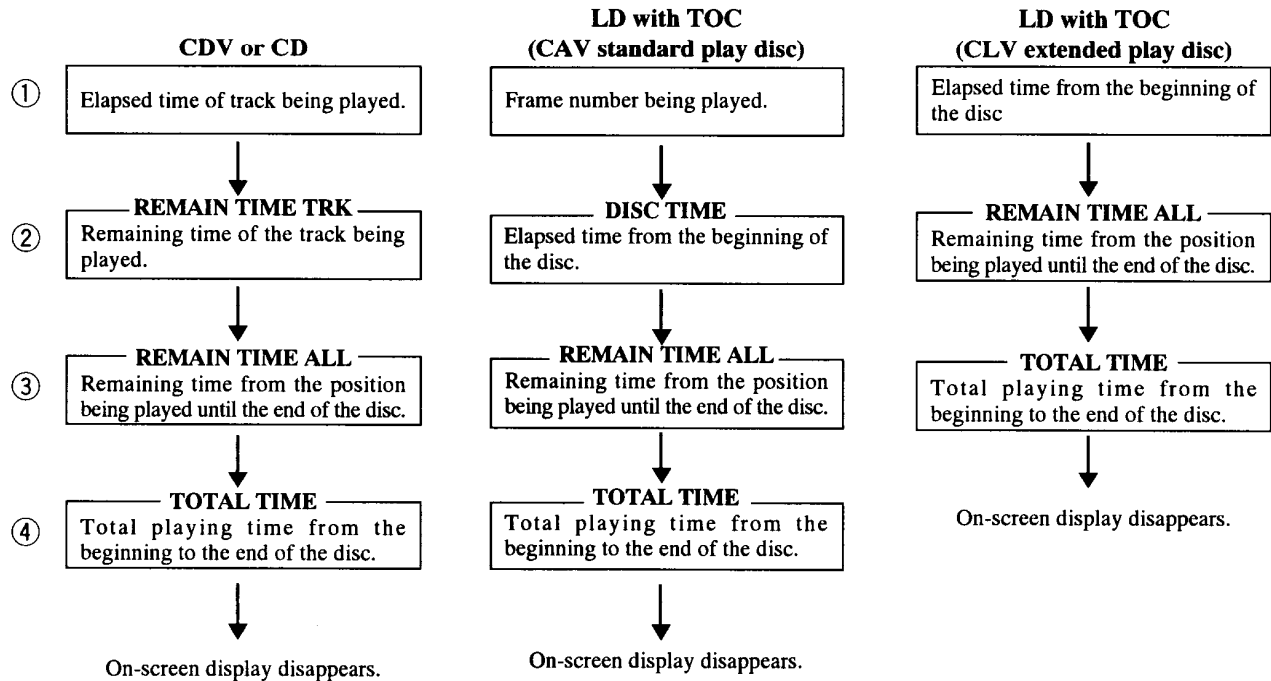

LD without TOC :

Only the frame number (CAV standard play disc) or the elapsed time from the beginning of the disc (CLV extended play disc) is displayed on the TV screen.

NOTE :
The DISC TIME, REMAIN TIME ALL, TOTAL TIME, and elapsed time displays, cannot be displayed when using quick reverse on, even if the LD has TOC. (P. 14) To display the information, stop playback, turn off the quick-reverse function and restart playback.

TROUBLESHOOTING

Incorrect operations are often mistaken for trouble and malfunctions. If you think that there is something wrong with this component, check the points below. Sometimes the trouble may lie in another component. Inspect the other components and electrical appliances being used. If the trouble cannot be rectified even after exercising the checks listed below, ask your dealer to carry out repair work.

Common for LD and CD

	Symptom	Causes	Ref. Page
Operation	1. The disc table closes and then re-opens.	<ul style="list-style-type: none"> ● The disc is extremely dirty. ● The disc is not placed properly on the disc table. ● Dew is condensed inside the player. 	p. 6 p. 12 p. 4
Remote control	2. Remote control is not possible. 3. The TV, etc., functions improperly.	<ul style="list-style-type: none"> ● The remote control unit is too far from the player or it is operated at too great an angle with respect to the remote control sensor. ● The batteries are run out. ● Some TV sets incorporating the wireless remote control function may function improperly due to the remote control unit of the player. 	p. 11 p. 5
Audio	4. Audio is not output or audio is distorted.	<ul style="list-style-type: none"> ● Connection plugs are inserted insufficiently or disconnected. ● Connection plugs or jacks are dirty. ● The player is in pause mode. ● The connection with the stereo amplifier is erroneous. ● The stereo amplifier is operated improperly. (Refer to the amplifier's instruction manual.) ● The player is connected to the PHONO input jacks of the stereo amplifier. ● ONE TOUCH KARAOKE is turned on. 	p. 9 p. 15

LD

	Symptom	Causes	Ref. Page
Video, picture quality	5. Video is not displayed. 6. Video is not displayed or the displayed video is of a low-quality or is noisy. 7. A part of the still image is shaking.	<ul style="list-style-type: none"> ● The TV power is off. ● The disc is extremely deformed (warped, etc.). ● The connection plug is not fully inserted or is disconnected. ● Even with the standard disc, a part of the still image may shake in the case it is a scene containing quick action. 	p. 6
Audio (LD)	8. Audio is vibrating. 9. Audio is not heard.	<ul style="list-style-type: none"> ● A disc without the  mark is being played with the CX system turned on. ● Audio is not output during multi-speed playback, still image and frame advance playback. 	p. 16 p. 18
Skip, search	10. Skip, programming and search are not possible. 11. Search takes a long time (more than 40 seconds). 12. The time taken to start playback is sometimes long. 13. Other image than specified is played back.	<ul style="list-style-type: none"> ● The disc being played does not contain recorded chapter numbers. (The functions utilizing the chapter numbers do not work on discs which do not contain chapter numbers.) ● Some discs need a longer time to read data. ● Error in data readout does occur sometimes. (This is not a malfunction.) ● Error in data readout does occur sometimes. (This is not a malfunction.) 	p. 17 p. 22

TROUBLESHOOTING

CD

	Symptom	Causes	Ref. Page
Operation (CD)	14. Playback stops immediately after it has been started.	<ul style="list-style-type: none"> ● The disc is extremely dirty. ● The disc is placed upside down. ● The disc is not placed properly on the disc table. 	p. 6 p. 12 p. 12

ONE TOUCH KARAOKE

	Symptom	Causes	Ref. Page
	15. The voice of the singer is not muted even when ONE TOUCH KARAOKE is pressed. 16. Playback will not stop when one chapter or track is finished.	<ul style="list-style-type: none"> ● The voice of the singer is not muted unless it is located on the center of the acoustic image. ● Chapters or tracks are not selected with the numeric buttons. 	p. 15

CAUTION :

Abnormal functioning of this unit may be caused by static electricity or other external interference. To restore normal operation, unplug the AC power cord and then plug it in again.

When troubles occur :

When some trouble occurs during use of the player, the following display (service number) appears on the display window of the player and the TV screen. If you experience this kind of trouble, follow the "Remedy" below.

Display window of the player

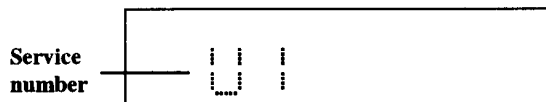

TV screen

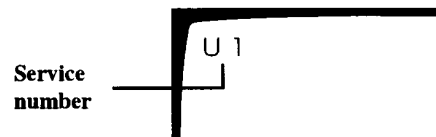

Service number	Condition of the player	Remedy
U1 U2	<ul style="list-style-type: none"> ● The disc is not loaded properly on the disc table. Or, the disc is dirty. 	<ul style="list-style-type: none"> ● Reload the disc along the disc guide groove on the disc table. ● Wipe the disc with a soft cloth. Open the disc table and press ► again.
F5 P2 L3 E4	<ul style="list-style-type: none"> ● Two discs are loaded on the disc table. Or, the disc is dirty. <p>(The displayed number after P, F, L and E differs depending on the condition of the player.)</p>	<ul style="list-style-type: none"> ● Load only one disc on the disc table. ● Wipe the disc with a soft cloth. ● Open the disc table and press ► again. ● If the same service number is displayed, the player is in abnormal condition. ● When requesting servicing, please mention the displayed number on the display window of the player or on the TV screen (for example, 'service number E4').
H0 H1 H2 A0	<ul style="list-style-type: none"> ● The player is in abnormal condition. 	<ul style="list-style-type: none"> ● When requesting servicing, please mention the displayed number on the display window of the player or on the TV screen (for example, 'service number H1').

SPECIFICATIONS

General

System LaserVision Disc system and
Compact Disc digital audio system
Laser Semiconductor laser wavelength 780 nm
Power requirement AC 120/220 V, 50/60 Hz
(automatic select)
Power consumption 37 W
Weight 7.7 kg
Dimensions 455 (W) x 407 (D) x 138 (H) mm
Operating temperature +5°C ~ +35°C
Operating humidity 5% ~ 85%
(There should be no condensation of moisture.)

Video characteristics (2 pairs)

Format NTSC specifications
Video output
Level 1 Vp-p nominal, sync. negative, terminated
Impedance 75 Ω unbalanced
Jacks RCA jacks

S VIDEO output (2 pairs)

Y output level 1 Vp-p (75Ω)
C output level 286 mVp-p (75Ω)
Jacks S VIDEO jacks

Audio characteristics (2 pairs)

Output level
During analog audio output 200 mVrms
(1 kHz, 40%)
During digital audio output 200 mVrms
(1 kHz, -20 dB)
Jacks Both RCA jacks
Number of channels 2 (Stereo)

Digital Audio Characteristics

Frequency response	4 Hz - 20 kHz
SN ratio	115 dB (EIAJ)
Dynamic range	96 dB (EIAJ)
Total harmonic distortion	Below 0.0035%
Wow and flutter	Below measurable limit (± 0.001% W.PEAK) (EIAJ)

LD is in compliance with EIAJ.

Other terminals

Optical digital output Optical digital jack
AC-3 RF OUT RCA jack

Accessories

Remote control unit 1
Size "AAA" (IEC R03) dry cell batteries 2
Video cord 1
Audio cord 1
Power source plug adapter 1
Power cord 1
Instruction manual 1

NOTE :

The specifications and design of this product are subject to change without notice, due to improvement.

ONKYO CORPORATION

Sales Planning & Promotion Dept.: 2-1, Nisshin-cho, Neyagawa-shi, OSAKA 572, JAPAN
Tel: 0720-31-8111 Fax: 0720-33-5222

ONKYO U.S.A. CORPORATION

200 Williams Drive, Ramsey, N.J. 07446, U.S.A.
Tel: 201-825-7950 Fax: 201-825-8150

ONKYO EUROPE ELECTRONICS GmbH

Industriestrasse 18-20, 82110 Germering, GERMANY
Tel: 089 84 93 20 Fax: 089 84 93 226

ONKYO FRANCE

Immeuble Le Diamant, Domaine Technologique de Saclay, 4 Rue René Raze.,
91892 SACLAY, FRANCE Tel: (1) 69 33 14 00 Fax: (1) 69 41 35 84