

CLD-2730K

NTSC

CD CDV LD PLAYER
REPRODUCTOR DE CD, CDV Y LD
CD, CDV, LD 鐳射碟影機

SPARE PARTS MASTER

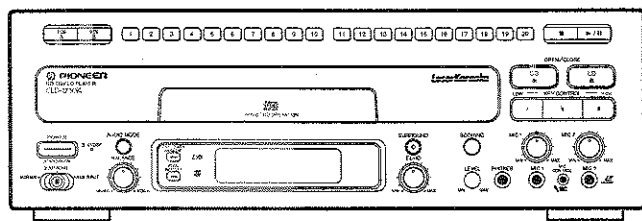

English

Español

中國語

- This player is not suitable for commercial use.
- LD-ROM, CD-ROM and CD graphic discs cannot be played with this player.

Thank you for buying this Pioneer product. Please read through these operating instructions so you will know how to operate your model properly. After you have finished reading the instructions, put them away in a safe place for future reference.

In some countries or regions, the shape of the power plug and power outlet may sometimes differ from that shown in the explanatory drawings. However, the method of connecting and operating the unit is the same.

WARNING: TO PREVENT FIRE OR SHOCK HAZARD, DO NOT EXPOSE THIS APPLIANCE TO RAIN OR MOISTURE.

IMPORTANT NOTICE

The serial number for this equipment is located on the rear panel. Please write this serial number on your enclosed warranty card and keep it in a secure area. This is for your security.

CAUTION: This product satisfies FCC regulations when shielded cables and connectors are used to connect the unit to other equipment. To prevent electromagnetic interference with electric appliances such as radios and televisions, use shielded cables and connectors for connections.

THE POWER SWITCH IS SECONDARY CONNECTED AND THEREFORE DOES NOT SEPARATE THE UNIT FROM MAINS POWER IN STANDBY POSITION.

LaserDisc

LaserKaraoke

COMPACT
disc
DIGITAL AUDIO

L
LASER DISC

LINE VOLTAGE SELECTOR SWITCH

Only multi-voltage models are provided with this switch. U.S., Canadian, European, U.K., and Australian models are not provided with this switch.

The line voltage selector switch is located on the rear panel of this player. Before your player is shipped from the factory, the switch is set to the power requirements of the player's destination. Check that it is set properly before plugging the power cord into the outlet. If the voltage is not properly set or if you move to an area where the voltage requirements differ, adjust the selector switch as follows:

Use a medium-sized (flat blade) screwdriver. Insert the tip of the screwdriver into the groove of the selector switch and turn it to set the player to the power voltage of your area.

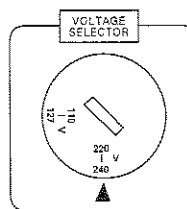

Set the selector so that arrow points to power voltage of your area (Figure shows arrow pointing to 220 - 240 volts.)

IMPORTANT



The lightning flash with arrowhead, within an equilateral triangle, is intended to alert the user to the presence of uninsulated "dangerous voltage" within the product's enclosure that may be of sufficient magnitude to constitute a risk of electric shock to persons.

CAUTION

RISK OF ELECTRIC SHOCK
DO NOT OPEN

CAUTION:
TO PREVENT THE RISK OF ELECTRIC SHOCK, DO NOT REMOVE COVER (OR BACK). NO USER-SERVICEABLE PARTS INSIDE. REFER SERVICING TO QUALIFIED SERVICE PERSONNEL.



The exclamation point within an equilateral triangle is intended to alert the user to the presence of important operating and maintenance (servicing) instructions in the literature accompanying the appliance.

SAFETY INSTRUCTIONS

READ INSTRUCTIONS – All the safety and operating instructions should be read before the appliance is operated.

RETAIN INSTRUCTIONS – The safety and operating instructions should be retained for future reference.

HEED WARNINGS – All warnings on the appliance and in the operating instructions should be adhered to.

FOLLOW INSTRUCTIONS – All operating and use instructions should be followed.

CLEANING – Unplug this video product from the wall outlet before cleaning. Do not use liquid cleaners or aerosol cleaners. Use a damp cloth for cleaning.

ATTACHMENTS – Do not use attachments not recommended by the video product manufacturer as they may cause hazards.

WATER AND MOISTURE – Do not use this video product near water – for example, near a bathtub, wash bowl, kitchen sink, or laundry tub, in a wet basement, or near a swimming pool, etc.

ACCESSORIES – Do not place this video product on an unstable cart, stand, tripod, bracket, or table. The video product may fall, causing serious injury to a child or adult, and serious damage to the appliance. Use only with a cart, stand, tripod, bracket, or table recommended by the manufacturer, or sold with the video product. Any mounting of the appliance should follow the manufacturer's instructions, and should use a mounting accessory recommended by the manufacturer.

CART – An appliance and cart combination should be moved with care. Quick stops, excessive force, and uneven surfaces may cause the appliance and cart combination to overturn.



VENTILATION – Slots and openings in the cabinet are provided for ventilation and to ensure reliable operation of the video product and to protect it from overheating. These openings must not be blocked or covered. They should never be blocked by placing the video product on a bed, sofa, rug, or other similar surface. This video product should never be placed near or over a radiator or heat register. This video product should not be placed in a built-in installation such as a bookcase or rack unless proper ventilation is provided or the manufacturer's instructions have been adhered to.

POWER SOURCES – This video product should be operated only from the type of power source indicated on the marking label. If you are not sure of the type of power supply to your home, consult your appliance dealer or local power company. For video products intended to operate from battery power, or other sources, refer to the operating instructions.

POWER-CORD PROTECTION

Power-supply cords should be routed so that they are not likely to be walked on or pinched by items placed upon or against them. Pay particular attention to cords at plugs, convenience receptacles, and the point where they exit from the appliance.

POLARIZATION – This video product is equipped with a polarized alternating current line plug (a plug having one blade wider than the other). This plug will fit into the power outlet only one way. This is a safety feature. If you are unable to insert the plug fully into the outlet, try reversing the plug. If the plug should still fail to fit, contact your electrician to replace your obsolete outlet. Do not defeat the safety purpose of the polarized plug.

LIGHTNING – For added protection for this video product receiver during a lightning storm, or when it is left unattended and unused for long periods of time, unplug it from the wall outlet and disconnect the antenna or cable system. This will prevent damage to the video product due to lightning and power-line surges.

POWER LINES – An outside antenna system should not be located in the vicinity of overhead power lines or other electric light or power circuits, or where it can fall into such power lines or circuits. When installing an outside antenna system, extreme care should be taken to keep from touching such power lines or circuits as contact with them might be fatal.

OVERLOADING – Do not overload wall outlets and extension cords as this can result in the risk of fire or electric shock.

OBJECT AND LIQUID ENTRY – Never push objects of any kind into this video product through openings as they may touch dangerous voltage points or short-out parts that could result in a fire or electric shock. Never spill liquid of any kind on the video product.

SERVICING – Do not attempt to service this video product yourself as opening or removing covers may expose you to dangerous voltage or other hazards. Refer all servicing to qualified service personnel.

DAMAGE REQUIRING SERVICE

Unplug this video product from the wall outlet and refer servicing to qualified service personnel under the following conditions:

- When the power-supply cord or plug is damaged.
- If liquid has been spilled, or objects have fallen into the video product.
- If the video product has been exposed to rain or water.
- If the video product does not operate normally by following the operating instructions. Adjust only those controls that are covered by the operating instructions. Improper adjustment of other controls may result in damage and will often require extensive work by a qualified technician to restore the video product to its normal operation.
- If the video product has been dropped or the cabinet has been damaged.
- When the video product exhibits a distinct change in performance – this indicates a need for service.

REPLACEMENT PARTS – When replacement parts are required, be sure the service technician has used replacement parts specified by the manufacturer or having the same characteristics as the original part. Unauthorized substitutions may result in fire, electric shock or other hazards.

SAFETY CHECK – Upon completion of any service or repairs to this video product, ask the service technician to perform safety checks to determine that the video product is in proper operating condition.

OUTDOOR ANTENNA GROUNDING – If an outside antenna is connected to the antenna terminal, be sure the antenna system is grounded so as to provide some protection against voltage surges and built-up static charges.

In the U.S.A. section 810 of the National Electrical Code, ANSI/NFPA 70, provides information with respect to proper grounding of the mast and supporting structure, grounding of the lead-in wire to an antenna discharge unit, size of grounding conductors, location of antenna-discharge unit, connection to grounding electrodes, and requirements for the grounding electrode.

See Fig. A.

NEC – NATIONAL ELECTRIC CODE

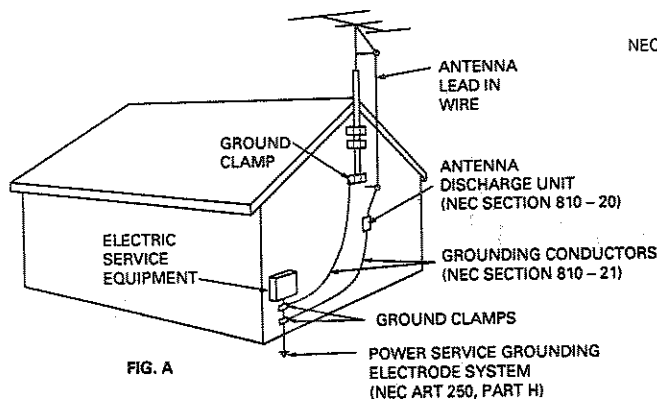

This equipment has been tested and found to comply with the limits for a Class B digital device, pursuant to Part 15 of the FCC Rules. These limits are designed to provide reasonable protection against harmful interference in a residential installation. This equipment generates, uses, and can radiate radio frequency energy and, if not installed and used in accordance with the instructions, may cause harmful interference to radio communications. However, there is no guarantee that interference will not occur in a particular installation. If this equipment does cause harmful interference to radio or television reception, which can be determined by turning the equipment off and on, the user is encouraged to try to correct the interference by one or more of the following measures:

- Reorient or relocate the receiving antenna.
- Increase the separation between the equipment and receiver.
- Connect the equipment into an outlet on a circuit different from that to which the receiver is connected.
- Consult the dealer or an experienced radio/TV technician for help.

Information to User

Alteration or modifications carried out without appropriate authorization may invalidate the user's right to operate the equipment.

CAUTION

- Use of controls or adjustments or performance of procedures other than those specified herein may result in hazardous radiation exposure.
- The use of optical instruments with this product will increase eye hazard.

Note to CATV system installer

This reminder is provided to call the CATV system installer's attention to Article 820-40 of the NEC that provides guidelines for proper grounding and, in particular, specifies that the cable ground shall be connected to the grounding system of the building, as close to the point of cable entry as practical.



Dear Customer:

Selecting fine audio equipment such as the unit you've just purchased is only the start of your musical enjoyment. Now it's time to consider how you can maximize the fun and excitement your equipment offers. This manufacturer and the Electronic Industries Association's Consumer Electronics Group want you to get the most out of your equipment by playing it at a safe level. One that lets the sound come through loud and clear without annoying blaring or distortion—and, most importantly, without affecting your sensitive hearing.

Sound can be deceiving. Over time your hearing "comfort level" adapts to higher volumes of sound. So what sounds "normal" can actually be loud and harmful to your hearing. Guard against this by setting your equipment at a safe level BEFORE your hearing adapts.

To establish a safe level:

- Start your volume control at a low setting.
- Slowly increase the sound until you can hear it comfortably and clearly, and without distortion.

Once you have established a comfortable sound level:

- Set the dial and leave it there.

Taking a minute to do this now will help to prevent hearing damage or loss in the future. After all, we want you listening for a lifetime.

We Want You Listening For A Lifetime

Used wisely, your new sound equipment will provide a lifetime of fun and enjoyment. Since hearing damage from loud noise is often undetectable until it is too late, this manufacturer and the Electronic Industries Association's Consumer Electronics Group recommend you avoid prolonged exposure to excessive noise. This list of sound levels is included for your protection.

Decibel

<u>Level</u>	<u>Example</u>
30	Quiet library, soft whispers
40	Living room, refrigerator, bedroom away from traffic
50	Light traffic, normal conversation, quiet office
60	Air conditioner at 20 feet, sewing machine
70	Vacuum cleaner, hair dryer, noisy restaurant
80	Average city traffic, garbage disposals, alarm clock at two feet.

THE FOLLOWING NOISES CAN BE DANGEROUS UNDER CONSTANT EXPOSURE

90	Subway, motorcycle, truck traffic, lawn mower
100	Garbage truck, chain saw, pneumatic drill
120	Rock band concert in front of speakers, thunderclap
140	Gunshot blast, jet plane
180	Rocket launching pad

Information courtesy of the Deafness Research Foundation.



ACCESSORIES

When unpacking the player, first check to make sure that all of the accessories listed below are supplied.

- Remote control unit
- Size "AAA" (IEC R03) dry cell battery x 2

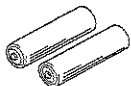

- Video cord
(Pin plug ↔ Pin plug)
Use to connect the player to a color monitor etc.

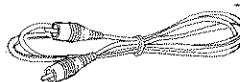

- Audio cord
(Pin plug x 2 ↔ Pin plug x 2)
Use to connect the player to a stereo amplifier etc.

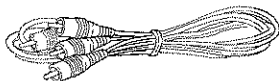

- Operating instructions
- Warranty card

CONTENTS

BEFORE OPERATING THE PLAYER

ACCESSORIES	4
PRECAUTIONS	5
TYPES OF DISCS THAT CAN BE PLAYED WITH THIS UNIT	6
CARE OF DISCS	7
CONNECTIONS	8
NAMES AND FUNCTIONS	10
REMOTE CONTROL OPERATIONS	12

BASIC OPERATION

TO PLAY AN LD, CDV OR CD	13
--------------------------------	----

VARIOUS OPERATIONS

CONVENIENT FUNCTIONS FOR KARAOKE - FOR PRACTICING	16
CONVENIENT FUNCTIONS FOR PLAYING AN LD, CDV OR CD	18
TO SEARCH FOR A PARTICULAR TIME/FRAME	19
TO PLAY ONLY DESIRED SCENES/TRACKS	20
TO REPEATEDLY PLAY A DESIRED PASSAGE	21
DISPLAY SWITCHING	22
TRUBLESHOOTING	23
SPECIFICATIONS	25

PRECAUTIONS

If it becomes necessary to transport or ship this unit in the future, be sure to first remove the disc (if loaded), and retract the disc table to its closed position. Then turn the power off, and, after the "OFF" display goes out on the display, disconnect the power cord.

INSTALLING THE PLAYER

- Place the player on a stable platform next to the television and stereo system to be used with the player.
- Do not place heavy objects such as a television or TV monitor on top of the player.
- Do not place the player on top of your TV set or TV monitor. Also, keep the player away from devices such as cassette decks which are sensitive to magnetic fields.

DO NOT INSTALL THE PLAYER IN THE FOLLOWING LOCATIONS

- In a place subject to direct sunlight.
- In humid or poorly ventilated places.
- In extremely hot or cold places.
- In a place subject to vibrations.
- In a dusty place.
- In a place subject to soot, steam or heat (in a kitchen, etc.)

AVOID SOURCES OF HEAT

Do not put the player on sources of heat, such as an amplifier. When installing with audio components on a rack, avoid components that generate heat, by placing the player below such components where there is adequate ventilation and not much dust. Avoid placing the player on surfaces such as shaggy carpets, beds, and sofas which may block ventilation under the player and cause damage.

CAUTION

Even when the player is in the pause mode, the disc-drive motor is still revolving. Since leaving the player in this condition can shorten the lifetime of the motor, do not leave the player in the pause mode for long periods of time. Also, to prevent the damage to the screen, do not use the unit for long periods of time under conditions in which the screen display (monitor) has been displayed characters (for example, power-ON mode, CD PLAY, PAUSE or DEMO mode (see back cover)). With LD discs, if playback is paused for about 20 minutes, the player will automatically enter stop mode.

STRIPE PATTERNS APPEARING ON A TV PROGRAM

Stripe patterns may appear during a TV program if the player unit is turned on, depending on the quality of reception of the TV station. This is neither a malfunction of the television nor the player. If stripes appear while watching the TV, or when watching the TV for long periods of time, turn the player off.



When FM or AM stations are being received, signal noise may be generated if the player is turned on. Turn off the player when not in use. Also, if there is signal noise when receiving radio stations with an indoor antenna, adjust the position or direction of the antenna.

CONDENSATION

Moisture will form in the operating section of the player if the player is brought from cool surroundings into a warm room or if the temperature of the room rises suddenly. When this happens, player's performance will be impaired.

To prevent this, let the player stand in its new surroundings for about an hour before switching it on, or make sure that the room temperature rises gradually.

Condensation may also form during the summer if the player is exposed to the breeze from an air conditioner. In such cases, change the location of the player.

POWER-CORD CAUTION

Handle the power cord by the plug. Do not pull out the plug by tugging the cord and never touch the power cord when your hands are wet as this could cause a short circuit or electric shock. Do not place the unit, a piece of furniture, etc., on the power cord, or pinch the cord. Never make a knot in the cord or tie it with other cords. The power cords should be routed such a way that they are not likely to be stepped on. A damaged power cord can cause fire or give you an electrical shock. Check the power cord regularly. When you find it damaged, ask your nearest PIONEER authorized service center or your dealer for a replacement.

CLEANING CARE

Use a soft, dry cloth for cleaning. For stubborn dirt, soak the cloth in a weak detergent solution; wring well first and wipe. Use a dry cloth to wipe it dry. Do not use any volatile agents such as benzine or paint thinner, as they may damage the surface of the player.

LD/CD lens cleaner

The player's pickup lens should not become dirty in normal use, but is for some reason it should malfunction due to soiling, ask your nearest PIONEER authorized service center. Lens cleaners for LD/CD players are commercially available, but special care should be exercised in their use since some may cause damage to the lens.

Abnormal functioning of this unit may be caused by lightning, static electricity, or other external interference. To restore normal operation, unplug the AC power cord and then plug it in again.

Only one disc can be loaded at any one time. Loading a LaserDisc, a Compact Disc, a 8 cm Compact Disc or a Compact Disc with Video on top of one another may result in a breakdown, or in scratching of the discs. Please only load one disc at a time.











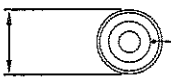

This player is to be used exclusively with the NTSC color system. Please use NTSC LaserDisc only. PAL and SECAM system discs cannot be used with this player.

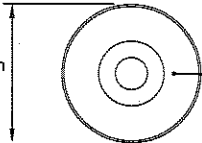

TYPES OF DISCS THAT CAN BE PLAYED WITH THIS UNIT

This unit is a CD VIDEO SYSTEM compatible player which can play CDs, CDV discs, and LDs.

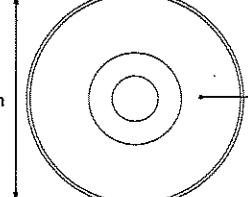
* The marks shown in the right column are printed on the labels and jackets of the corresponding discs.

This player can play the following seven types of discs without using an adapter.

<p>CD Single (one-side recording)</p>  <p>8 cm</p> <p>Digital audio (max. 20 min.)</p>	
<p>CD (one-side recording)</p>  <p>12 cm</p> <p>Digital audio (max. 74 min.)</p>	
<p>CDV (one-side recording)</p>  <p>12 cm</p> <p>Digital audio (max. 20 min.) (Audio part)</p> <p>Digital audio + Video (max. 5 min.) (Video part)</p>	<p>**</p> 
<p>VSD (Video Single Disc) (one-side recording)</p>  <p>12 cm</p> <p>Digital audio + Video (max. 5 min.)</p> <p>● In the operating instructions in this manual, the VSD is treated as a kind of CDV.</p>	<p>VIDEO SINGLE DISC</p> 
<p>LD Single (one-side recording)</p>  <p>20 cm</p> <p>Digital/analog audio + Video (CAV: Max. 14 min. CLV: Max. 20 min.)</p>	<p>*</p> 
<p>LD (two-side or one-side recording)</p>  <p>20 cm</p> <p>Digital/analog audio + Video (CAV: Max. 14 min. per side CLV: Max. 20 min. per side)</p>	<p>*</p> 
<p>LD (two-side or one-side recording)</p>  <p>30 cm</p> <p>Digital/analog audio + Video (CAV: Max. 30 min. per side CLV: Max. 60 min. per side)</p>	<p>**</p> 

- There are some discs marked with the  mark instead of the  mark.
- There are some disc without the  mark.

HOW TO PLACE A DISC

Place the disc in the correct position by using the appropriate disc guide groove.

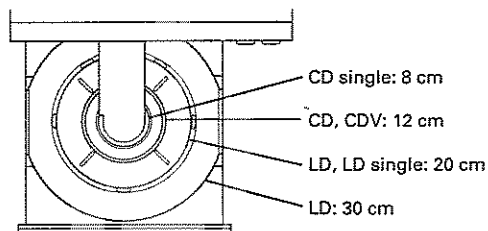

LD GLOSSARY

Chapter number

Chapter numbers are used to indicate the boundaries of the sections on a disc. If chapter numbers are recorded on a disc, it is so indicated on the jacket of the disc, etc.

Frame number

Frame numbers are the numbers assigned to each picture frame on a CAV disc.

Time number

Time numbers indicate the time elapsed from the beginning of a CLV disc.

CDV/CD GLOSSARY

Track number

Track numbers indicate the boundaries of the sections, or "tracks", on a disc. Track numbers are assigned consistently throughout the audio part and video part of a CDV disc.

TOC

The TOC (Table of Contents) section is just like the table of contents of a book, and contains information on the contents (number of tracks, playing time, etc.) of the disc.

- Some LD discs are not provided with a TOC section.

* This is the unified symbol mark of LASERDISC (LaserVision videodisc).

LaserDisc players and discs which bear this symbol and use the same television system, are mutually compatible.

** A Digital Sound with Multi Audio Disc (CD VIDEO LD) and a CDV (CD Video CDV) are referred to as CD Video discs. CD Videodiscs are recorded with subcodes, which are the non-audio recordings of TOC (Table of Contents) data such as track numbers, index numbers, etc. However, there are some discs without these marks.

CARE OF DISCS

CD VIDEO SYSTEM

The CD VIDEO SYSTEM is the standard name for the "optical video disc with digital audio" system that encompasses both LDs and CDV discs.

The following mark is the standard mark for the CD VIDEO SYSTEM and is found on all players and discs which conform to the CD VIDEO SYSTEM format.

The following systems are included in the CD VIDEO SYSTEM:



- CDV (CD VIDEO CDV) discs
- LaserVision Discs (CD VIDEO LDs) containing digital audio with sub codes
- Compatible players which can play CDs and CDV discs
- Compatible players which can play CDs, CDV discs, and LDs

CD VIDEO LDs

A CD VIDEO LD is an LD with digital audio which is encoded with sub codes (data such as TOC and track number data, excluding audio and video signals).

LDs (LASERDISCS)

Two types of standard LaserDisc are available — standard play (CAV) discs and extended play (CLV) discs — which differ with respect to their signal recording systems.

CAV DISCS

The jackets and labels of these discs are marked with a "Standard Play Disc CAV" or "Standard Play" indication.

CLV DISCS

The jackets and labels of these discs are marked with a "Extended Play Disc CLV" or "Extended Play" indication.

LASERVISION DISCS WITH DIGITAL AUDIO

The jackets and labels of these discs bear the following mark.

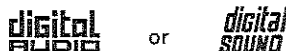

These are LaserDiscs which contain digital audio signals in addition to conventional analog audio signals. This feature allows the high image quality of LaserDiscs to be enjoyed together with the superior quality of digital audio.

LASERVISION MULTI AUDIO DISCS WITH DIGITAL AUDIO

The jackets and labels of these discs bear the following mark.



These are LaserDiscs in which the recorded digital and analog audio signals differ in content. This allows the user to enjoy two different audio soundtracks by switching between the digital and analog audio.

CDV (COMPACT DISC WITH VIDEO) DISCS

These are compact discs which also contain video signals. Of the total 25-minute playback time of a CDV disc, 20 minutes is encoded with conventional CD digital audio signals (the "audio part"). The remaining 5 minutes is encoded with both video and digital audio signals (the "video part").

In normal playback mode, the unit plays the audio part after the video part is played back.

How to hold discs

When loading or removing discs, try not to touch their playing surfaces.



Cleaning

Fingerprints or other dirt on the disc may affect sound and picture quality.

To clean your discs, use a soft clean cloth to wipe them. If necessary, moisten a soft cloth with diluted neutral detergent to remove heavy dirt or fingerprints.



Do not wipe in a circular direction
(Concentric scratches in the disc groove tend to cause noise.)

Gently wipe from the inside toward the outer edge.

Discs must not be cleaned with record cleaning sprays, or static prevention sprays, etc. Also do not use volatile liquids such as benzene, or thinner, etc.

NEVER PLAY CRACKED OR WARPED DISCS.

- The disc revolves in the player at a high speed when it is played. Never play a cracked, scratched or warped disc. This may damage the player or cause it to malfunction.

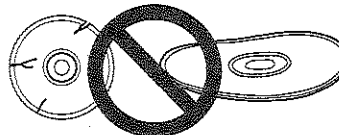

After using discs, store them upright

After playing a disc, always remove it from the player and return it to its jacket. Then store it standing upright away from heat and humidity.

- Store discs carefully. If you store discs at an angle, or stacked on top of each other, discs may become warped even when in their jackets.
- Do not leave discs in locations such as the seat of car, which may become excessively hot.

If an LD disc is warped...

If an LD disc is warped, put the disc into its protective envelope, and then place it between two flat boards. Then place heavy books on top of the boards so that approximately 4 to 5 kg is applied. Leave the disc like this for a day or so. This may correct the warp.

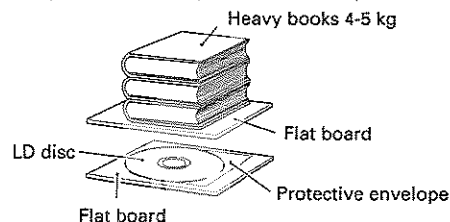

CAUTION WHEN USING THE DISC

All rights reserved.
Unauthorized public performance, broadcasting or copying is a violation of applicable laws.

CONNECTIONS

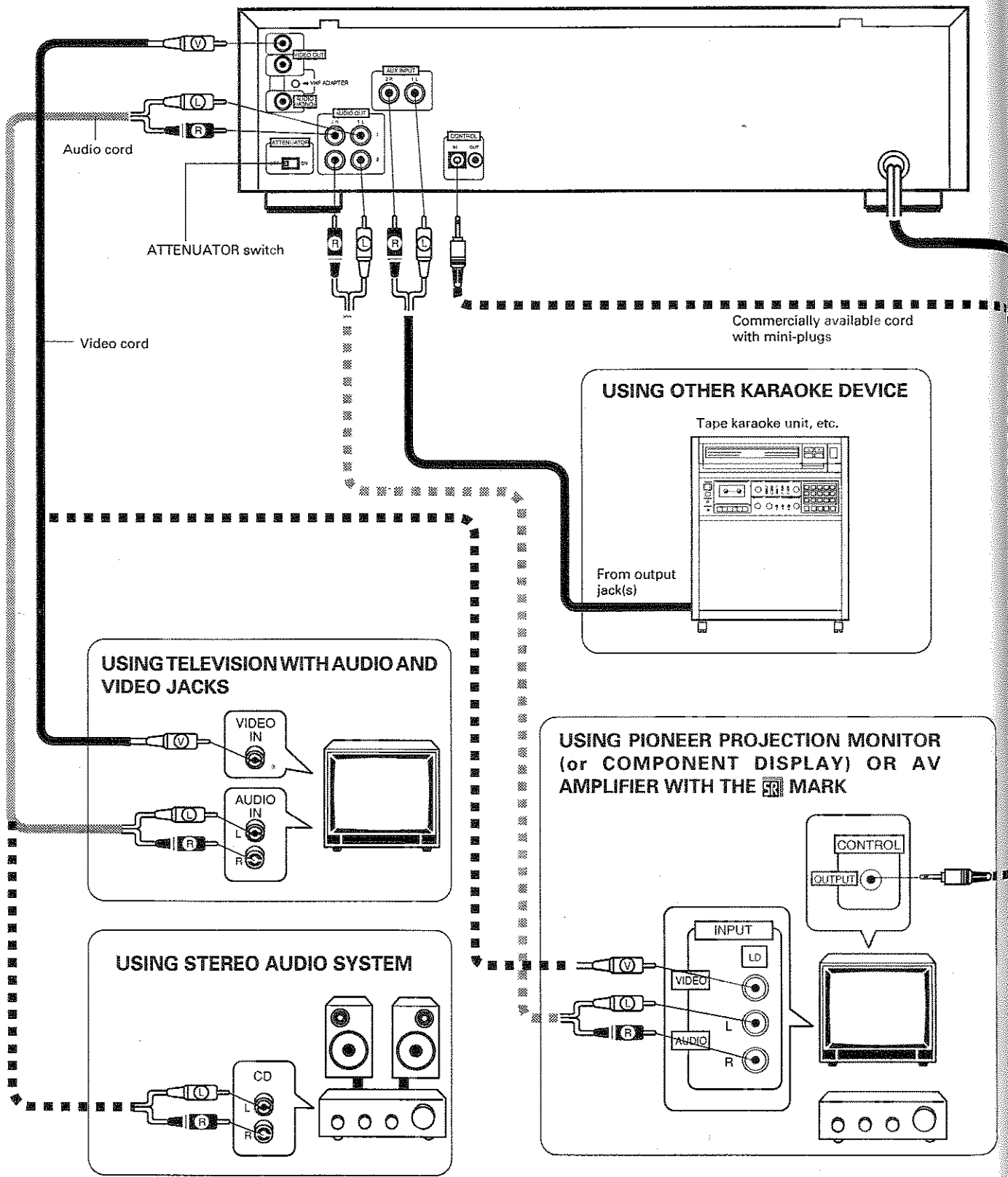



PLUG THE POWER CORDS INTO AN AC OUTLET

Plug the AC power cords of the player, stereo amplifier and TV set into an AC outlet. When the power cord of this unit is connected to an AC outlet, power is supplied to the unit's internal memory (such as the last memory) even when the POWER switch is off (STANDBY). Therefore, be sure to connect the power cord directly to a wall outlet. If the power cord is connected to an outlet such as a switched outlet on an amplifier, the various memory contents will be erased whenever the amplifier's power switch is turned off.

CONNECTING TV AND STEREO AMPLIFIER

- Connect the VIDEO OUT jack of the player to the video input jack of the monitor television.
- Connect the AUDIO OUT jacks to the stereo amplifier AUX, CD, LD, VDP or other jacks, except the PHONO input jacks. The television speakers can also be used by connecting the television audio input jacks and the player AUDIO OUT jacks. However, connection to a stereo amplifier is recommended to obtain superior audio playback quality for Compact Discs and LaserDiscs.
Do not change the television antenna and VCR connections.

THE SR MARK

System control can be performed when the player is combined with an optional AV amplifier, which can provide centralized control of Pioneer products with the SR mark.

Connect the VIDEO OUT jack of the player to the video disc video input jack of the AV amplifier and connect the AUDIO OUT jacks of the player to the audio input jacks of the AV amplifier.

Connect the CONTROL IN jack of the player to the CONTROL OUT jack of the AV amplifier using a commercially available cord with mini-plugs.

- For details concerning the connection and operation methods, please refer to the operating instructions for the AV amplifier.

ATTENUATOR SWITCH

When the television speakers are used, the sound may be distorted. In this case, set the ATTENUATOR switch to ON to reduce the distortion.

NAMES AND FUNCTIONS

Front panel:

A detailed description is provided on the indicated page(s).

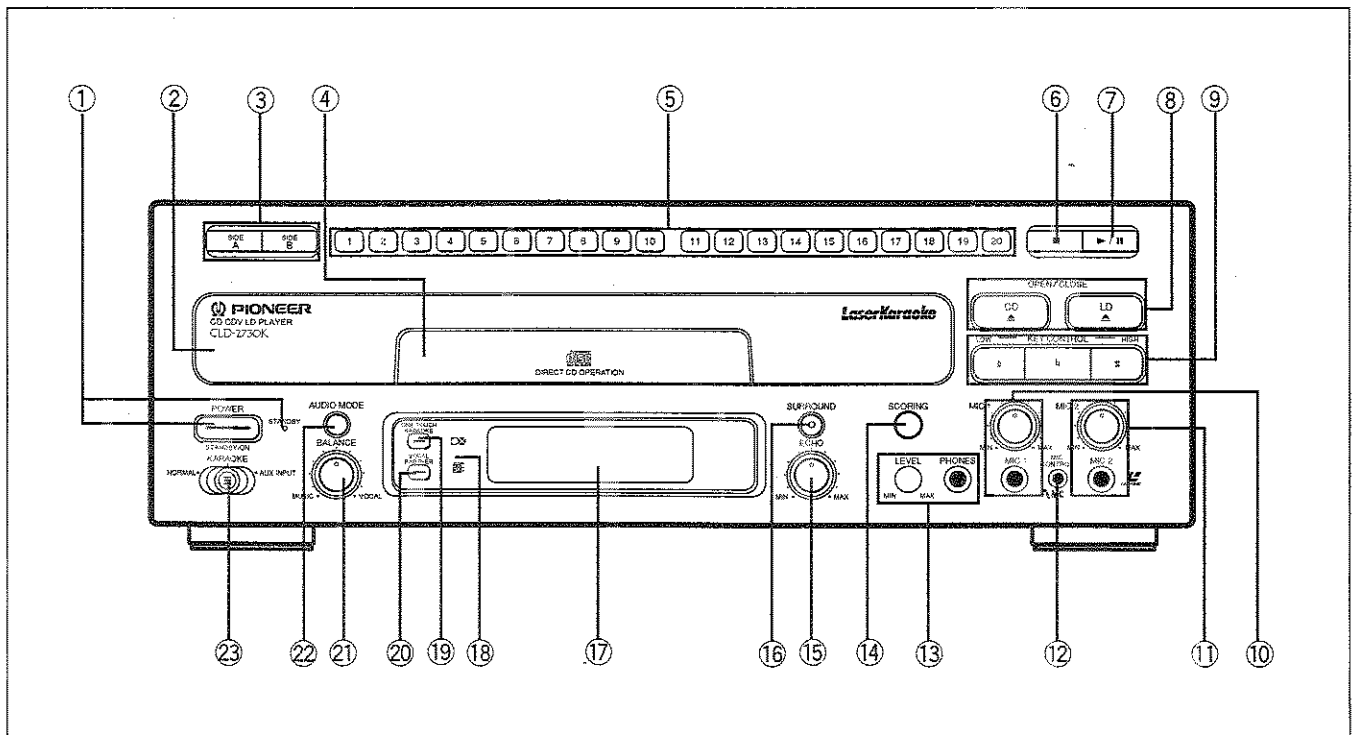

- ① **POWER STANDBY/ON switch and STANDBY indicator**
Press to turn the power on and off.
- ② **Disc table ... p. 13**
- ③ **SIDE A/SIDE B buttons ... p. 14**
- ④ **CD Disc table ... p. 13**
- ⑤ **Direct music search buttons ... p. 13, 17, 20**
- ⑥ **Stop (■) button ... p. 14**
- ⑦ **Play/Pause (▶/||) button ... p. 13, 14**
- ⑧ **OPEN/CLOSE (CD ▲/LD ▲) buttons ... p. 13, 14**
- ⑨ **KEY CONTROL buttons ... p. 16**
- ⑩ **MIC 1 jack and MIC 1 level control ... p. 13**
- ⑪ **MIC 2 jack and MIC 2 level control ... p. 13**
- ⑫ **MIC CONTROL jack ... p. 13**
- ⑬ **PHONES jack and LEVEL control ... p. 18**
- ⑭ **SCORING button/indicator ... p. 17**
- ⑮ **ECHO level control ... p. 16**
- ⑯ **SURROUND button/indicator ... p. 16**
- ⑰ **Display window**
- ⑱ **Remote sensor ... p. 12**
- ⑲ **ONE-TOUCH KARAOKE button/indicator ... p. 16**
- ⑳ **VOCAL PARTNER button/indicator ... p. 14, 17**
- ㉑ **BALANCE control ... p. 15**
- ㉒ **AUDIO MODE button ... p. 13, 15, 18**
- ㉓ **NORMAL/KARAOKE/AUX INPUT selector ... p. 13, 15, 18**

Display window

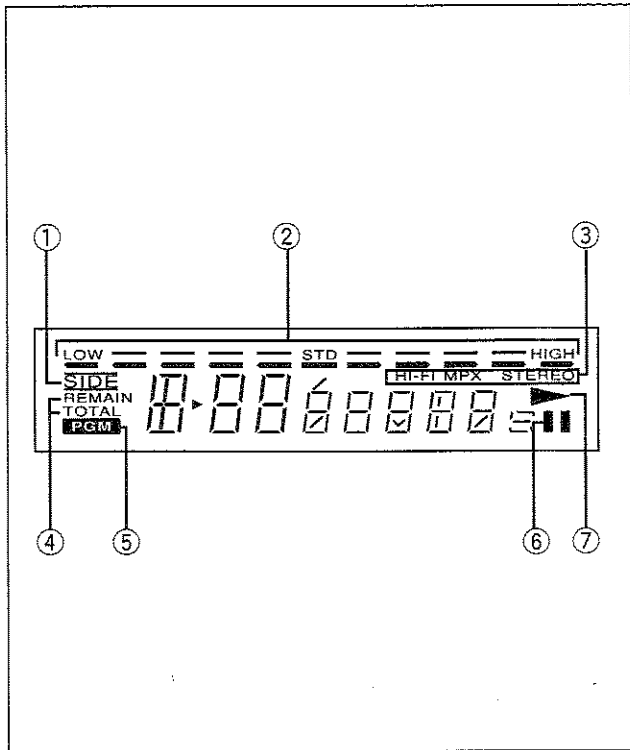

- ① SIDE indicator
- ② Key control indicator
- ③ Audio mode indicators
- ④ REMAIN/TOTAL indicator
- ⑤ PGM indicator
- ⑥ || Pause indicator
- ⑦ ▶ Play indicator

Remote control unit:

Remote control buttons with the same names or marks as buttons on the front panel of the player control.

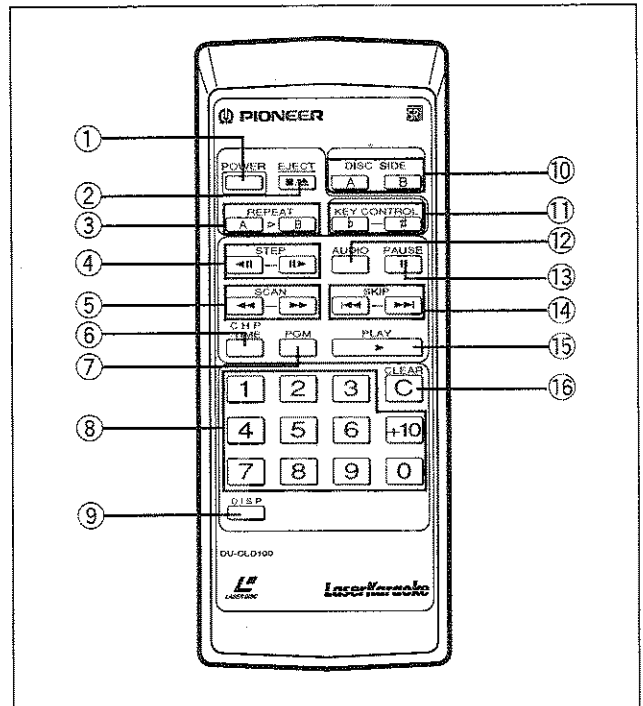

- ① POWER button ... p. 13
- ② EJECT button ... p. 13
- ③ REPEAT A/B buttons ... p. 21
- ④ STEP buttons ... p. 18
- ⑤ SCAN buttons ... p. 19
- ⑥ CHP/TIME (Chapter/Time) button ... p. 19
- ⑦ PGM (Program) button ... p. 20
- ⑧ Digit buttons ... p. 13, 20
- ⑨ DISP button ... p. 22
- ⑩ DISC SIDE A/B buttons ... p. 14
- ⑪ KEY CONTROL buttons ... p. 16
- ⑫ AUDIO button ... p. 18
- ⑬ PAUSE button ... p. 14
- ⑭ SKIP buttons ... p. 18
- ⑮ PLAY button ... p. 13
- ⑯ CLEAR button ... p. 19, 20

REMOTE CONTROL OPERATIONS

INSERTING BATTERIES INTO THE REMOTE CONTROL UNIT

Open the battery compartment cover on the back of the remote control unit.

Insert size "AAA" (IEC R03) dry cell batteries into the battery compartment in accordance with the indications (\oplus , \ominus) inside the compartment.

Close the cover of the battery case.

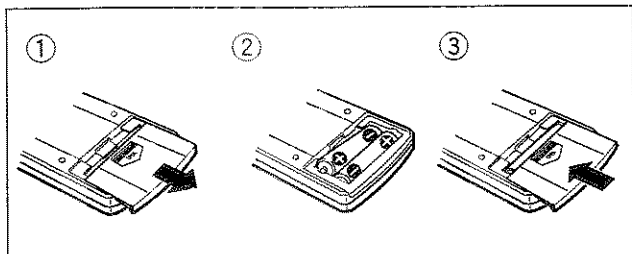

Incorrect use of batteries may cause leakage or rupture.

Always be sure to follow these guidelines:

- A. Always insert batteries into the battery compartment correctly matching the positive \oplus and negative \ominus polarities, as shown by the display inside the compartment.
- B. Never mix new and used batteries.
- C. Batteries of the same size may have different voltages, depending on brand. Do not mix different brands of batteries.

When the unit is not to be used for a long period of time (more than one month), remove the batteries to prevent them from leaking inside the compartment. If leakage occurs, wipe up the liquid inside the compartment and replace the batteries with new ones.

Remote controllable range

Angle: Within 30 degrees to the left and right of the center line

Distance: Less than 7 m

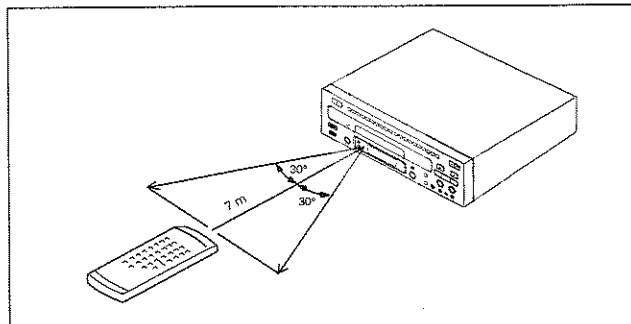

NOTES FOR USING THE REMOTE CONTROL UNIT:

- If a plug is connected to the CONTROL IN terminal at the rear of the player, remote control operations cannot be done with the remote control unit aimed at the player's remote control sensor. Aim the remote control unit at the control component display's sensor instead.
- If the player is used simultaneously with another appliance using infrared rays, the player may operate improperly. Should this happen, change the place of installation so that improper operation does not occur.
- If the range of operation of the remote control unit becomes too short, replace the batteries.
- If the remote control sensor window is in a position where it receives strong light such as sunlight or fluorescent light, control may not be possible.

TO PLAY AN LD, CDV OR CD

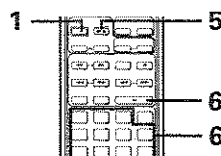
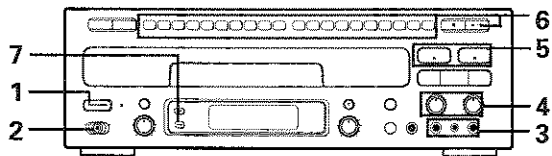

NORMAL PLAYBACK	KARAOKE PLAY	PLAYBACK WITH USING OTHER DEVICES
------------------------	---------------------	--

1 Turn on the power to this player.

<p>2 Set the NORMAL/KARAOKE/AUX INPUT selector to the NORMAL position.</p>	<p>2 Set the NORMAL/KARAOKE/AUX INPUT selector to the KARAOKE position.</p>	<p>2 Set the NORMAL/KARAOKE/AUX INPUT selector to the AUX INPUT position.</p>
---	--	--

3 Connect and turn on the microphone(s).
 About microphones:
 When using a separately sold microphone such as the Pioneer Microphone DM-V161, connect the control-use miniplug to the player's MIC CONTROL (MC) jack.

4 Adjust the microphone level.

5 Load a disc.

- If EJECT (▲/■) on the remote control unit is pressed to open the disc table: The LD disc table comes out when an LD is loaded. The CD disc table comes out when a CD is loaded.

6 Start playback.

<p>When starting playback from the first chapter or track on a disc:</p>	<p>When starting playback from the desired chapter or track on a disc: (Example) starting playback from track No. 3</p>
--	---

7 Select the channel of the audio output with the AUDIO MODE button.

<ul style="list-style-type: none"> When using digital audio discs: Playback starts with digital audio. When using analog audio discs: Switch to CX ON with discs bearing CX mark. Refer to page 18 for details. 	<ul style="list-style-type: none"> When using sound multiplexed CD karaoke discs: Press AUDIO MODE so that the MPX indicator lights. When using general CDs or CDVs (with vocal) as karaoke discs: Press AUDIO MODE so that the STEREO indicator lights. 	<ul style="list-style-type: none"> If the auxiliary input component is a stereo device: Press AUDIO MODE so that the STEREO indicator lights. If the auxiliary input component is a sound multiplexed device: Press AUDIO MODE so that the MPX indicator lights. Refer to page 18 for details.
--	--	---

TO PLAY AN LD, CDV OR CD

■ When KARAOKE play is finished

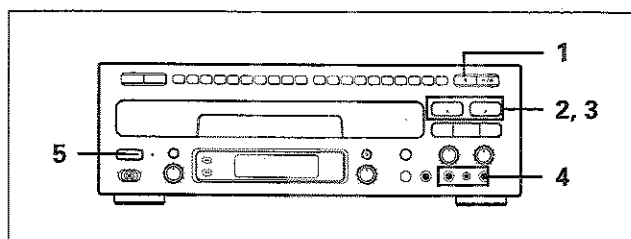

1 Press the stop (■) button.

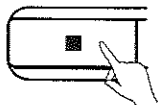

2 Press the OPEN/CLOSE (CD ▲/LD ▲) button.

- When EJECT (■/▲) on the remote control unit is pressed, the disc table on which a disc is loaded comes out.

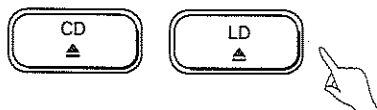

3 Take out a disc and press the OPEN/CLOSE (CD ▲/LD ▲) button to close the disc table.

- Be sure to close the disc table completely.

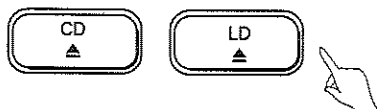

4 (Except for normal playback) Turn off the microphone(s) and unplug the microphone's plug from the MIC jack.

- With the microphone having the mini-plug for control, unplug the mini-plug for control first and then unplug the microphone's plug.

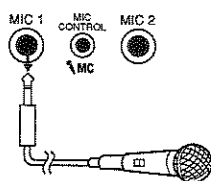

5 Turn off the power of the player.

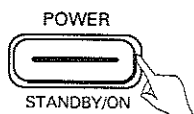

■ If some of the Direct music search buttons are pressed sequentially

- The last selected track is played back.
- Be sure to press the Direct music search button which corresponds to the chapter number or the track number.

■ To search for chapter or track number 10 or above

Use [+10] button.

(Example) To enter 17: [+10], [7]

To enter 30: [+10], [+10], [+10], [0]

■ If howl occurs

- Keep away the microphone from the speakers.
- Decrease the output level of the microphone by turning the MIC 1 or MIC 2 level control counterclockwise.
- Decrease the volume level by turning the **VOLUME** control of the amplifier counterclockwise.

■ If sound distortion occurs

- Set the **ATTENUATOR** switch on the rear panel to the ON position. (See page 8,9.)

■ About the microphone

- Clean the microphone's plug. If the plug is dirty, it may result in noise.
- Use a microphone for karaoke. If using the microphone not for karaoke, it may cause of insufficient volume level or howling.

■ To select a song on the other side (For two-sided LDs)

Specify side A or side B with **SIDE A** or **B** and then select a song using the **Direct music search** buttons.

■ To use the VOCAL PARTNER function (Except for general CDs, CDVs or LDs):

- Turn the **BALANCE** control to the VOCAL side.
- Press **VOCAL PARTNER** so that the indicator lights. When you sing into the microphone, your voice replaces the original vocals on the disc. This function is useful when practicing duets.

■ To pause playback temporarily

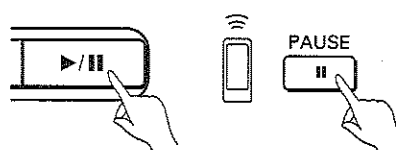

Press ►/|| or **PAUSE** || again to resume playback.

■ To specify and play a single side (side A or side B)

To play side A only, press **SIDE A** instead of ►/||. Side A will be played and then playback will stop.

To play side B only, press **SIDE B** instead of ►/||. Side B will be played and then playback will stop.

* Precautions concerning disc loading

- Do not place more than one disc on the disc table. If two discs are placed one on top of the other on the disc table, discs may be scratched and/or a malfunction may occur.
- Playback is not possible unless the disc is placed properly.

To avoid malfunctions, be especially careful about the following points.

- Do not place any object other than a disc on the disc table.
- Do not move the player while a disc is playing. This will cause the disc to be scratched.
- Be careful not to catch your finger in the disc table section while the disc table is being retracted into the unit. Also, be careful that children do not put their hands into the inside of the unit while the disc table is open. This may cause injury.

Audio output selected with the AUDIO MODE button

This function is carried out when the **NORMAL/KARAOKE/AUX INPUT** selector is set to **KARAOKE** position.



The audio output can be selected according to discs being played. The audio mode indicator lights and shows which audio mode is selected.

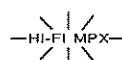

[When HI-FI MPX lights] With multi audio karaoke discs with digital audio, digital/analog audio is output.







[When STEREO lights] Stereo sound is output.



[When MPX lights] Multiplexed audio is output.

Laserdisc (LD)

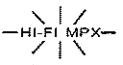
- When using a multi audio disc with digital audio

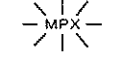
Discs bearing  LD ,  or  and MULTI AUDIO marks (*1)		Digital audio accompaniment and analog audio vocals are output. Vocal output level can be adjusted with the BALANCE control.
		Digital audio accompaniment is output. The BALANCE control cannot be used.
		Analog audio accompaniment and vocals are output. Vocal output level can be adjusted with the BALANCE control.

NOTE:

Sometimes the sound becomes unnatural with discs having no TOC. In this case, press **AUDIO MODE** so that the **MPX** indicator lights.

*1: The **MPX** indicator lights with discs bearing  **LD**,  or  and **MULTI AUDIO** marks.

- When using multiplexed discs (without digital audio)

The audio mode automatically switches to the multiplexed sound mode. (Switching the audio mode cannot be carried out.)		Both accompaniment and vocals are output. The BALANCE control can be used.
--	---	---

- When using stereo disc

The audio mode automatically switches to the stereo mode. (Switching the audio mode cannot be carried out.)		Stereo sound is output. The BALANCE control can not be used.
---	---	---

Compact disc (CD, CDV)

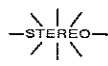
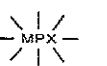
	Stereo sound is output.		Monaural output in the multiplexed sound mode. With multi audio discs, the BALANCE control can be used.
---	-------------------------	---	--

CONVENIENT FUNCTIONS FOR KARAOKE - FOR PRACTICING

To adjust the microphone echo level

In karaoke, AUX mode

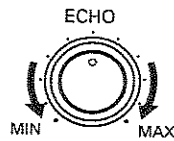

Echo is increased by turning the control to the right and decreased by turning the control to the left.

To create a live atmosphere (Surround function)

In karaoke, normal, AUX mode

SURROUND



On screen displays for SURROUND

Lights	Function
SURRND	Surround function
THEATER	Theater
KARAOKE	Karaoke
MUSIC	Music
OFF	Surround off

Press the **SURROUND** button, then select **THEATER**, **KARAOKE** or **MUSIC** to create the desired atmosphere.

THEATER: Creates an atmosphere suitable for movie discs.
KARAOKE: Creates an atmosphere suitable for karaoke play.
MUSIC: Creates an atmosphere suitable for music discs.

NOTE:

With discs whose volume level is excessive high, sound may be distorted when the surround function is activated. In this case, set **SURROUND** to **OFF**.

To set a desired pitch (Key control function)

In karaoke, AUX mode

LOW — KEY CONTROL — HIGH

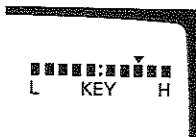

- # : Pitch is heightened each time this button is pressed (up to 5 steps from normal).
- h : Pitch returns to normal.
- b : Pitch is lowered each time this button is pressed (down to 5 steps from normal).
- The current pitch position is shown by the lit indicator.

NOTE:

Key control does not function when the **NORMAL/KARAOKE/AUX INPUT** selector is set to the **NORMAL** position.

To change to karaoke play at the touch of button

In karaoke, normal, AUX mode

ONE-TOUCH
KARAOKE



- You can use this function to change to karaoke play even with general stereo discs. With some discs, however, the singer's voice may remain audible.
- **ONE-TOUCH KARAOKE** function is carried out in stereo playback mode or multiplexed playback mode.
- With multiplexed CD karaoke discs, the **ONE-TOUCH KARAOKE** function is carried out when the "MPX" indicator lights by pressing **AUDIO MODE**.
 With general stereo discs (LD, CD or CDV), the **ONE-TOUCH KARAOKE** function is carried out when the "STEREO" indicator lights by pressing **AUDIO MODE**. It is very useful to practice karaoke with general stereo discs (LD, CD or CDV), for vocal level on discs is reduced.

To repeat a section to correct a singing mistake

Only in karaoke mode

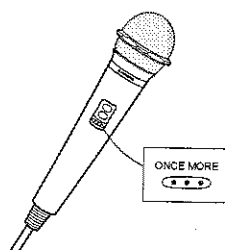

This function can be operated with the microphone sold separately (Pioneer DM-V161).

Each time **ONCE MORE** is pressed, playback returns to a point a little earlier in the song.

However, the position will not return to a point earlier than the beginning of the selected song.

When playback returns to the beginning of the selected song and pauses, press **II** or **ONCE MORE** to start playback.

- If you press **ONCE MORE** while the player is in pause mode, playback will resume. (Once more start function)

CONVENIENT FUNCTIONS FOR KARAOKE - FOR PRACTICING

To use the "Vocal Partner" function so that the original vocals are replaced with your voice when you sing



For Example:

With duets, you can sing only the male (female) part and let the original vocals sing the female (male) part. This is convenient for practicing only the male (female) part.

Vocal scoring system

(only for discs with **digital MULTI AUDIO** or **digital** and **MULTI AUDIO** mark. This function cannot be carried out with discs whose analog audio is stereo sound or on which no vocals are recorded.)

Your karaoke song is scored compared with vocals recorded on the disc. When you finish to sing karaoke, press **PAUSE (II)**. The score is displayed and then the bells are rung and cheers are heard according to the score.

1 Set the NORMAL/KARAOKE/AUX INPUT selector to the KARAOKE position.

2 Press the SCORING button.

SCORING

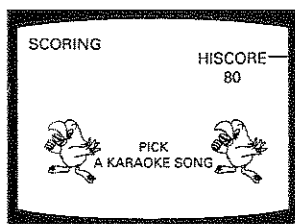

High score of the last time (When the power is turned off, the score returns to 0 point.)

3 Select the karaoke song with the Direct music search buttons.

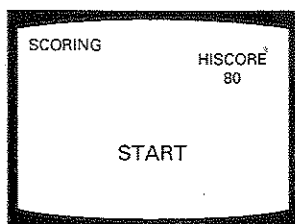

- With discs which cannot be scored (LD, CD or CDV whose analog audio is not multiplexed sound), "INACTIVE" is displayed for about 8 seconds.
- When selecting songs, use the Direct music search buttons on the front panel or the Digit buttons on the remote control unit. ▶/II or PLAY ▶ cannot be used.

4 Sing a karaoke song.

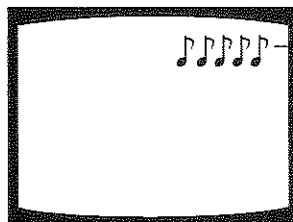

The part where vocals are recorded ...

When singing karaoke in tune:

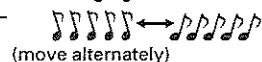

(move alternately)

When singing karaoke out of tune:

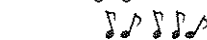

(move disorderly)

The part where vocals are not recorded ...

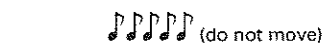

If II is pressed after finishing karaoke:

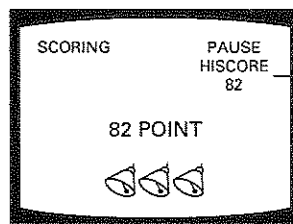
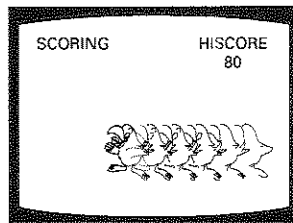

When the score is better than before, the high score is renewed.

The bells are ringing. the number of the displayed bell:
 less than 60 points : 0
 more than 60 points : 1
 more than 70 points : 2
 more than 80 points : 3
 Only when the high score is displayed, cheers are heard.

After several seconds, the player automatically returns to step 2. You can try another karaoke song repeating steps 2 and 3.

To return to normal karaoke mode:

- Press the **SCORING** button again.
- Press **CLEAR** on the remote control unit.

During scoring ...

- The fast-forward, fast-reverse, once more or key control function can be carried out.
- When the another karaoke song is selected, the previous score displayed on the screen is reset.

NOTES:

- During selecting the chapter or displaying the score, PAUSE (II), PLAY (▶), SKIP (◀◀, ▶▶) and SCAN (◀◀, ▶▶) do not function.
- The following functions are not performed in scoring mode. Repeat, Surround, Programming, Clear Scan, Time display on the screen, Audio mode, Channel mode
- Scoring mode cannot be carried out with CD, CDV or Video single discs.
- Scoring mode cannot be carried out with discs bearing the "MULTI AUDIO" mark.

- Depending on the karaoke disc, the player may not precisely check the vocals even on the disc bearing the "MULTI AUDIO" mark. In this case, the player cannot score properly your karaoke play. This is not a malfunction.
- With karaoke discs bearing the "MULTI AUDIO" mark and having no digital audio, the vocals recorded on the disc are not decreased even when the BALANCE control is turned to the VOCAL position.
- When singing karaoke with narration, the narration's part is also scored.

CONVENIENT FUNCTIONS FOR PLAYING AN LD, CDV OR CD

Audio switching

This function is carried out when the NORMAL/KARAOKE/AUX INPUT selector is set to the NORMAL position.



To listen to only one channel of a stereo disc, or to select the audio on a sound multiplex disc:

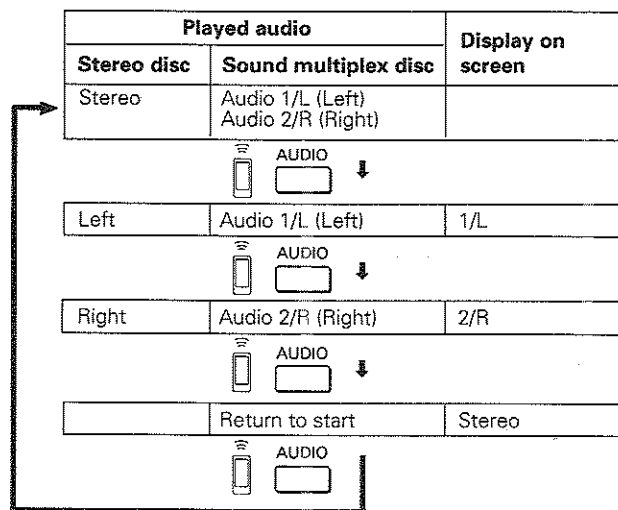

To listen to the analog audio of an LD digital audio disc:

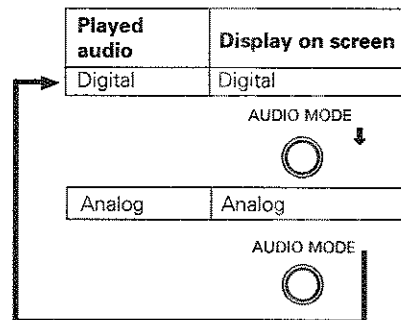

With a Multi Audio disc (an LD bearing the mark and the MULTI AUDIO mark or the mark), you can listen to the various audio tracks recorded on the disc by using **AUDIO MODE** to select between the analog and digital tracks, and by using **AUDIO** to select between the left (1/L) and right (2/R) channels.

Chapter (Track) Skip - To search for the beginning of a chapter/track

LD/CD/CDV

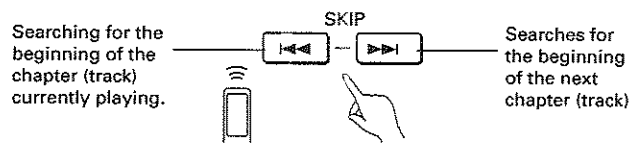

Press a button repeatedly or hold it depressed; the chapters (tracks) will be skipped successively.

Still frame and Frame -by-Frame advance function (CAV disc only)

LD

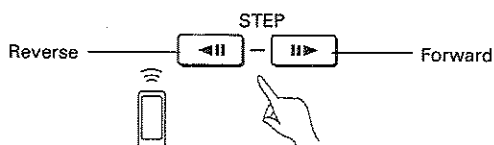

Press repeatedly for frame-by-frame advance.

Discs marked with the mark

Discs marked are recorded with the CX noise reduction system for powerful audio reproduction with little noise. (Analog audio only) However, some discs marked are not encoded with the signals necessary to instruct the unit to automatically switch on the CX system. If sound is noisy or undulates when a disc with a mark is played, press **AUDIO MODE** on the front panel.

- is a trademark of CBS Inc. This player meets the CX EXPANDING SPECIFICATION.

To play and listen to a disc without connecting this unit to an audio system:

Plug headphones into the PHONES jack on the front panel of this unit and adjust the volume with LEVEL.

Automatic picture stop

Some of discs contain a recording of a special code called the "picture stop code", which turns normal play or slow play automatically into still frame display.

To cancel the automatic picture stop operation, press and hold for more than 2 seconds until "PSC ON" (picture stop cancel ON) is displayed on the screen. To re-activate, press and hold for more than 2 seconds again until "PSC OFF" is displayed.

(or on the remote control unit cannot be used.)

CONVENIENT FUNCTIONS FOR PLAYING AN LD, CDV OR CD

◀▶▶▶ Scan (Manual Search) - Search using fast forward or fast reverse

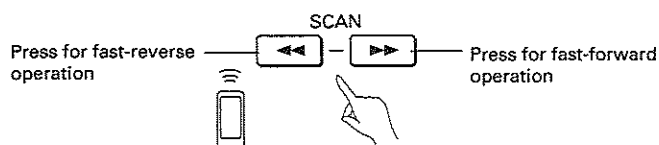

Normally Clear Scan is performed. To perform Low Scan and High Scan, press **DISP** on the remote control unit to display the screen and then press **SCAN** button. For about two seconds after the button is pressed, Low Scan is performed, after that, the unit enters High Scan.

Clear Scan mode: The image may not fluctuate in this mode.

Low Scan mode: Scan speed becomes about 10x the normal playback speed.

High Scan mode: Scan speed becomes about 30x the normal playback speed.

- With CDs or audio part of CDVs, Clear Scan mode cannot be carried out.
- With video part of CDV, High Scan mode cannot be carried out.
- In Clear Scan mode, when digital sound is selected with digital audio discs, sound is heard at low volume level. In karaoke mode, sound is muted.
- With CDs or audio part of CDVs, sound is heard at low volume while scanning.
- Others: Sound is muted.

LD/CDV/CD

TO SEARCH FOR A PARTICULAR TIME/FRAME

Frame Number Search/Time Number Search/Track time Search/ABS Time Search

SEARCHING OF LD DISC

Frame Number Search (CAV discs only) - To search by designating the frame number

Any desired frame can be searched for by specifying its frame number.

1. Press **CHP/TIME** during playback.
When the display shows chapter NO., press this button again. "Frame 0" is displayed.
2. Enter the required frame number with the digit buttons (0 - 9).
3. Press **▶/II** or **PLAY ▶**.

Time Number Search (CLV disc only) - Example: To search for the scene located at 12 min. 34 sec

1. Press **CHP/TIME** during playback.
When the display shows chapter No., press this button again.
2. Enter **1**, **2**, **3** and **4** with the digit buttons.
3. Press **▶/II** or **PLAY ▶**.

CAUTION:

If a disc does not contain information in seconds, specify the time number only in the minutes.

When **PLAY ▶** on the remote control unit is pressed to start search operation:

A still frame is displayed (CAV). To start normal playback, press **PLAY ▶** again.

SEARCHING OF CD DISC

Track Time Search (CD/CDV discs only) - To search for a time on a specified track

1. Press **CHP/TIME**.
2. Press **◀◀** or **▶▶** so that the desired track number appears in the front panel display window.
3. Enter the track time (elapsed time from the beginning of the specified track) with the digit buttons (0 - 9).
4. Press **▶/II** or **PLAY ▶**.

ABS Time Search (CD discs only) - To search for a point by designating the elapsed time from the beginning of the disc

1. Press **CHP/TIME**, so that "Ab" appears in the front panel display window. (On the monitor screen, "ABS" appears.)
2. Enter the elapsed time from the beginning of the disc with the digit buttons (0 - 9).
3. Press **▶/II** or **PLAY ▶**. Playback starts from the specified elapsed time.

Notes on searching for a chapter/track:

- If you make a mistake in pressing the digit buttons, press **CLEAR** and press the correct digit buttons.
- The +10 button does not function.

To exit search mode:

Press **CLEAR**. Normal playback starts.

TO PLAY ONLY DESIRED SCENES/TRACKS – Program Playback

Selected chapters (LD) or tracks (CDV/CD) can be played in any desired order (max. 24 chapters or tracks).

1. Press PGM.

Display with a disc containing a TOC

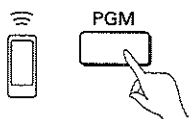

3	0.12	PLAY
TOTAL TIME	0 0.00	PROGRAM STEP-1
>	---	---
---	---	---
---	---	---

2. Enter the track No. with the DIRECT MUSIC SEARCH buttons on the front panel or with the digit buttons on the remote control unit.

Example: To play CD tracks No. 9, No. 7, and No. 18 respectively.

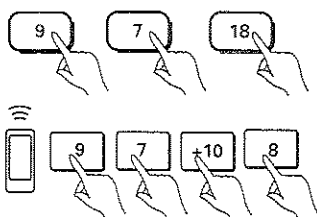

After approx. 1 second

3	0.32	PLAY
TOTAL TIME	3 8.30	PROGRAM STEP-4
09 07 18 >	---	---
---	---	---
---	---	---

With two-sided LDs, first specify side A or side B with DISC SIDE A or B and then enter the number of the desired chapter with the digit buttons.

Example: To program chapter 9 on side B, chapter 7 on side A, and chapter 18 on side B, in that order.

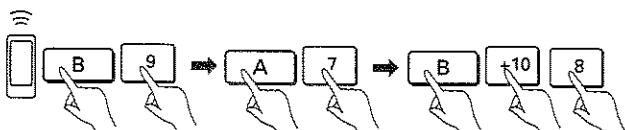

Screen display after programming is completed

3	0.12	A PLAY
		PROGRAM STEP-4
B09 A07 B18 >	---	---
---	---	---
---	---	---

A pause between tracks/chapters can also be programmed by pressing **PAUSE II** instead of the digit buttons.

If you make a mistake during entry:

Press **CLEAR** on the remote control unit and enter the correct number with the digit buttons.

3. Press >/II or PLAY >.

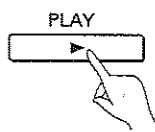
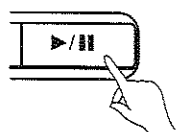

- You can view the state of programming on the monitor TV screen.

To check the program contents

During program playback or in stop mode, press **PGM** to display the program contents on the monitor screen. When **PGM** is pressed again, the program contents disappear.

To modify the program contents

To delete or change a programmed chapter/track or pause:

- Press **PGM**.
- Press **SKIP** <<< or >>> to place the cursor (>) on the left side of the chapter/track or pause to be changed.
- To delete it, press **CLEAR**. To replace it with another chapter/track, enter the new chapter/track number with the digit buttons.

Press **PAUSE II** to enter a pause.

- Press **PGM** to complete programming. Pressing > also completes programming and starts program playback with the new program contents.

- Programmed chapter/track being played cannot be erased or changed.
- Programmed pause being engaged cannot be erased or changed.

To clear the program playback

Press **CLEAR** to return to normal playback.

To clear the program contents:

- Open the disc table.
- Press **CLEAR** in stop mode.

NOTES:

- If **SCAN** >>> is held depressed during Program Playback, the playback position will move to another chapter/track, but when >>> is released, the next chapter/track in the program will be played. If <<< is held depressed, the playback position returns to the beginning of the current chapter or track being played, but it will not go beyond it to a previous chapter or track in the program.
- During program playback, **SKIP** <<< and >>> can be used to skip the programmed chapters/tracks or pause.

TO REPEATEDLY PLAY A DESIRED PASSAGE – Repeat Playback

Memory Repeat – To specify a point to return to later

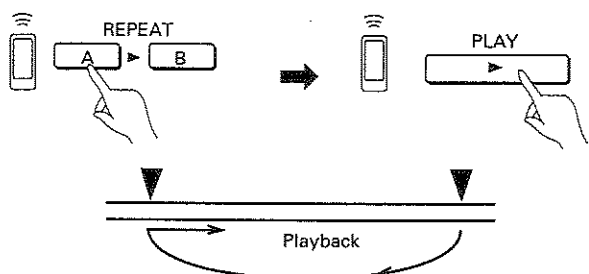

Press **REPEAT A** on the remote control unit at the point you want to see or listen to again (point A).

When you wish to return to point A, press **PLAY ►** on the remote control unit.

A-B Repeat – To repeat a specified section

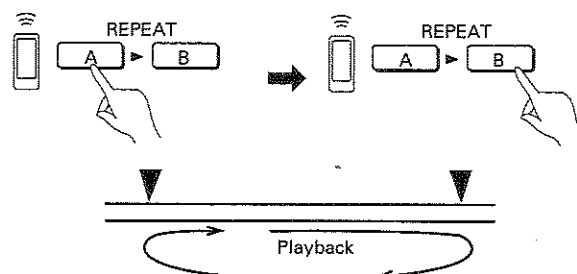

Press **REPEAT A** on the remote control unit at the start point of the section to be repeated.

Press **REPEAT B** on the remote control unit at the end point of the section to be repeated. Playback returns to the beginning of the section and the section is repeated continuously.

Chapter/Track Repeat – To repeat the current chapter or track

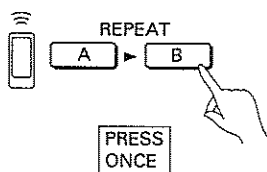

Press **REPEAT B** on the remote control unit while the chapter/track to be repeated is playing.

When the end of the chapter/track is reached, the player returns to the beginning of the chapter/track and the chapter/track is played back repeatedly.

Program Repeat – To repeat a program

With the program repeat function, you can repeatedly play programmed chapters or tracks in their programmed order.

Press **REPEAT B** on the remote control unit while the program is being played.

- See page 20 for details on programming.

One Side Repeat – To repeat an entire side of a disc

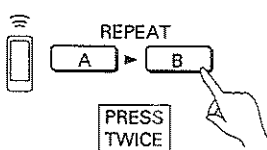

Press **REPEAT B** on the remote control unit twice.

When playback reaches the end of the playback side, the player returns to the beginning of the disc and the same side is played back repeatedly.

Two-Side Repeat – To repeat both side of a disc (for two-sided LDs only)

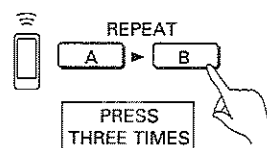

Press **REPEAT B** on the remote control unit three times. Sides A and B are played back repeatedly. "Repeat ALL" appears on the monitor screen.

To exit repeat mode:

Press **CLEAR** on the remote control unit.

To specify a different point in Memory Repeat mode:

Press **REPEAT A** at the new point. The previously memorized point is erased and replaced with the new point.

Memory Repeat and A-B Repeat with CDV discs:

These repeat functions can only be carried out within the video part or within the audio part, and cannot be carried out between the two parts.

With LDs which have no chapter numbers:

Chapter repeat cannot be carried out.

DISPLAY SWITCHING

DISP on the remote control unit allows you to display information including the play mode and disc playing time on the screen. Each press of **DISP** switches the screen display as shown below.

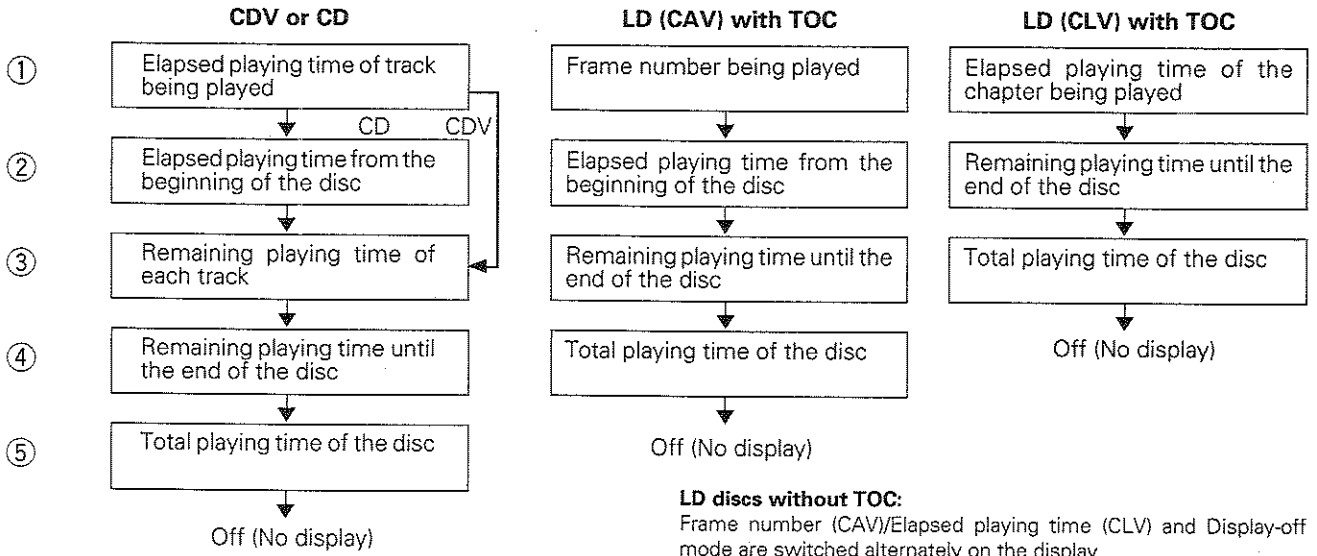

LD discs without TOC:
Frame number (CAV)/Elapsed playing time (CLV) and Display-off mode are switched alternately on the display.

Audio output level meter display:

During elapsed play time of the track mode of CD playback or CDV (audio part) playback, the audio output level meter will be displayed on the monitor screen.

During playback, if you press the remote control unit's **DISP** button, the following information screens will appear.

NOTE:

In some cases, the displayed output level may differ from the actual output level, but this is not a malfunction.

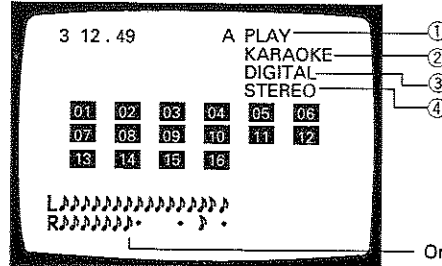
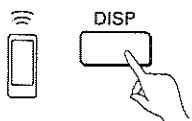

- ① Player status
- ② Player mode:
KARAOKE: Karaoke mode
NORMAL: Normal mode
AUX: Auxiliary input mode
- ③ Playback audio
DIGITAL: Digital audio
ANALOG: Analog audio
- ④ Audio mode
HIFI MPX: Hi-Fi multiplex sound
MPX: Multiplex sound
STEREO: Stereo sound

Only for your reference

The actual screen display is as shown below.

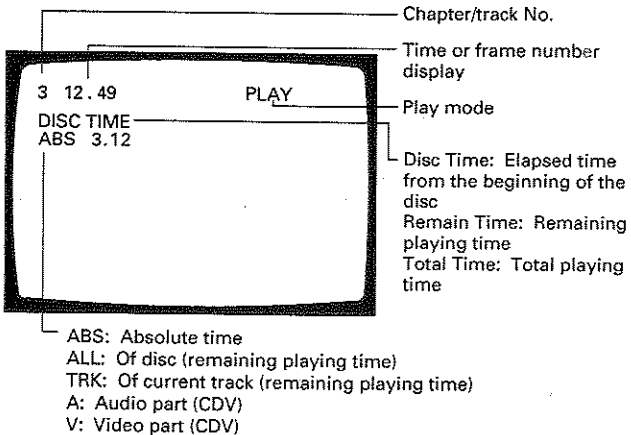

State of the display window during playback:

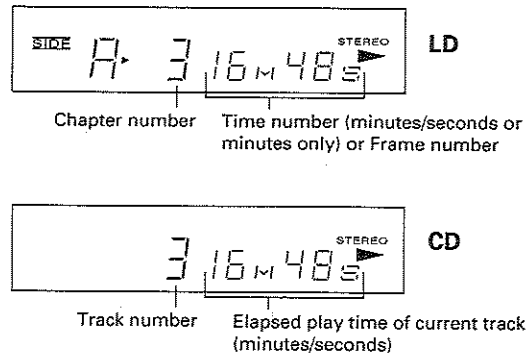

TROUBLESHOOTING

Incorrect operations are often mistaken for trouble and malfunctions. If you think that there is something wrong with this component, check the points below. Sometimes the trouble may lie in another component. Inspect the other components and electrical appliances being used. If the trouble cannot be rectified even after exercising the checks listed below, ask your nearest PIONEER authorized service center or your dealer to carry out repair work.

Common to LD and CD

	Symptom	Possible Causes	Reference Page
Operation	1. Power is not turned on even though the POWER switch is ON.	<ul style="list-style-type: none"> ● Power cord is not properly plugged into the AC wall socket. 	p. 8, 9
	2. Playback stops immediately. Noise on the screen or sound is distorted.	<ul style="list-style-type: none"> ● Disc is dirty. ● Disc is warped. ● Moisture has condensed on a disc. 	p. 7 p. 7
	3. Disc table comes out.	<ul style="list-style-type: none"> ● Moisture has condensed on parts in the player. 	p. 5
	4. ►/II does not function.	<ul style="list-style-type: none"> ● A disc is not loaded properly on the disc table. 	p. 13

LD

	Symptom	Possible Causes	Reference Page
Video, picture quality	5. No video output even though a disc is rotating. (Picture quality is poor or picture is fluctuated.)	<ul style="list-style-type: none"> ● Connection is wrong. 	p. 8, 9
Audio (LD)	6. Audio sound is undulating.	<ul style="list-style-type: none"> ● A disc having no CX mark is played with the CX system ON. ● A multiplexed audio karaoke disc with digital audio is played back in Hi-Fi multi sound mode. 	p. 18 p. 13, 15

CD

	Symptom	Possible Causes	Reference Page
Audio (CD)	7. Hum noise is output.	<ul style="list-style-type: none"> ● Influenced from TV. 	

TROUBLESHOOTING

KARAOKE

	Symptom	Possible Causes	Reference Page
	8. The One-Song Pause function or other KARAOKE functions cannot be operated.	<ul style="list-style-type: none"> ● The NORMAL/KARAOKE/AUX INPUT selector is set to the NORMAL position. 	p. 13
	9. No sound.	<ul style="list-style-type: none"> ● The NORMAL/KARAOKE/AUX INPUT selector is set to the AUX INPUT position. 	p. 13
	10. The BLANCE control does not function.	<ul style="list-style-type: none"> ● The NORMAL/KARAOKE/AUX INPUT selector is set to the NORMAL position. ● The AUDIO MODE button is set to the STEREO position. 	p. 13 p. 15
	11. Hi-Fi stereo multiplexed sound is not possible.	<ul style="list-style-type: none"> ● The NORMAL/KARAOKE/AUX INPUT selector is set to the NORMAL position. ● The Hi-Fi stereo multiplexed audio disc is not used. 	p. 13, 15
	12. The volume level of the original vocal is not reduced even when ONE-TOUCH KARAOKE is pressed.	<ul style="list-style-type: none"> ● The AUDIO MODE button is not set to the appropriate audio mode with a CD or auxiliary device. 	p. 16

Except for karaoke

	Symptom	Possible Causes	Reference Page
Video, picture quality	13. When switching to TV broadcasting, the picture quality is poor with stripes compared with before the player is connected.	<ul style="list-style-type: none"> ● Stripes on the screen is sometimes influenced by the condition of the electric wave. It is not a malfunction of the player or TV. 	p. 5

Remote control

	Symptom	Possible Causes	Reference Page
	14. Improper operation of TV sets occurs when using the remote control unit.	<ul style="list-style-type: none"> ● With some TV sets having the wireless remote control unit, improper operation may occur by using the remote control unit supplied with the player. 	

CAUTION:

Abnormal functioning of this unit may be caused by lightning, static electricity, or other external interference. To restore normal operation, unplug the AC power cord and then plug it in again.

SPECIFICATIONS

General

System	LaserVision Disc system and Compact Disc digital audio system
Laser	Semiconductor laser wavelength 780 nm
Power requirements	AC 110 - 127/220 - 240 V (Switchable), 50/60 Hz
Power consumption	44 W
Weight	8.0 kg (17 lbs 10 oz)
Dimensions	420 (W) x 431 (D) x 140 (H) mm
Operating temperature	+5 °C ~ +35 °C
Operating humidity	5 % ~ 85 % (There should be no condensation of moisture.)

Video characteristics (two pairs)

Format	NTSC specifications
Video output	
Level	1 Vp-p nominal, sync. negative, terminated
Impedance	75 Ω unbalanced
Jack	RCA jack

Audio characteristics (two pairs)

Output level	
During analog audio output	200 mVrms (1 kHz, 40 %)
During digital audio output	200 mVrms (1 kHz, -20 dB)
Jacks	Both RCA jacks
Number of channels	2 (Stereo)

Other terminals

Control input/output	Both miniature jacks
AUX	RCA jacks
VHF adapter output (Video/Audio)	Both RCA jacks with DC jack

Accessories

Remote control unit	1
Size "AAA" (IEC R03) dry cell batteries	2
Video cord	1
Audio cord	1
Operating instructions	1
Warranty card	1

NOTE:

The specifications and design of this product are subject to change without notice, due to improvement.

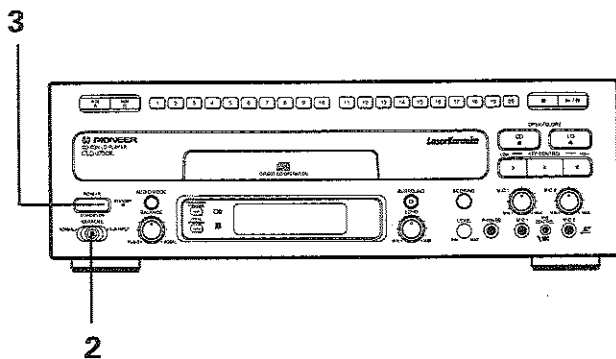

About DEMO mode

On-screen display of scoring mode will appear on the TV screen with following operation.

- 1 Turn on the power of the TV connected to this player.
 - Set the input selector of the TV to the player input (VTR, VCR, VD, etc.).
- 2 Set the NORMAL/KARAOKE/AUX INPUT selector to the KARAOKE position.
- 3 Turn on the power of the player by pressing the POWER button.

To cancel DEMO mode

- Press one of the operation buttons on this player. The display of DEMO mode is cancelled.
- In step 2, if the NORMAL/KARAOKE/AUX INPUT selector is set to the NORMAL position and the power is turned on, the player will not enter DEMO mode.

When using the Projection Monitor, do not leave the DEMO display on the screen for an extended period of time. The TV screen may be damaged.

Acerca del modo DEMO

La visualización en pantalla del modo de partitura aparecerá en la pantalla del televisor con la operación siguiente.

- 1 Conecte la alimentación del televisor conectado a este reproductor.
 - Ponga el selector de entrada del televisor en la posición correspondiente a la entrada del reproductor (VTR, VCR, VD, etc.)
- 2 Ponga el selector NORMAL/KARAOKE/AUX INPUT en la posición KARAOKE.
- 3 Conecte la alimentación del reproductor pulsando el botón POWER.

Para cancelar el modo DEMO

- Pulse uno de los botones de operación de este reproductor. La visualización del modo DEMO se cancelará.
- En el paso 2, si se pone el selector NORMAL/KARAOKE/AUX INPUT en la posición NORMAL y se conecta la alimentación, el reproductor no entrará en el modo DEMO.

Cuando utilice el monitor de proyección, no deje la visualización DEMO en la pantalla durante mucho tiempo. La pantalla del televisor podría estropearse.

關於演示方式

進行下述操作後電視機屏幕上會出現評分方式的顯示。

- 1 打開與本播放機相接的電視機電源開關。
 - 將電視機的輸入選擇設為播放機輸入（如 VTR, VCR, VD 等）。
- 2 將 NORMAL/KARAOKE/AUX INPUT（正常/卡拉 OK/外部輸入選擇開關）置於 KARAOKE（卡拉 OK）。
- 3 按 POWER（電源）鍵以打開本播放機。

取消演示方式

- 按本播放機的任一操作鍵後，演示方式的顯示即被取消。
- 在第2步中，如果 NORMAL/KARAOKE/AUX INPUT 開關是置於 NORMAL 位置上而打開電源，播放機不會進入演示方式。

如果使用投射型電視機，請勿使屏幕長時間處於演示方式顯示，否則電視屏幕可能會受損。

LaserDisc is a trademark of Pioneer Electronic Corporation.

LaserDisc es una marca registrada de Pioneer Electronic Corporation.

LaserDisc 是先鋒電子株式會社的商標。

Published by Pioneer Electronic Corporation.
Copyright © 1994 Pioneer Electronic Corporation.
All rights reserved.

PIONEER ELECTRONIC CORPORATION 4-1, Meguro 1-Chome, Meguro-ku, Tokyo 153, Japan

PIONEER ELECTRONICS [USA] INC. 2265 East 220th Street, Long Beach, California 90810, U.S.A.

P.O. BOX 1720, Long Beach, California 90801, U.S.A.

PIONEER ELECTRONICS OF CANADA, INC. 300 Allstate Parkway Markham, Ontario L3R 0P2, Canada

PIONEER ELECTRONIC [EUROPE] N.V. Haven 1087 Keetberglaan 1, 9120 Melsele, Belgium, TEL: 03/750.05.11

PIONEER ELECTRONICS AUSTRALIA PTY. LTD. 178-184 Boundary Road, Braeside, Victoria 3195, Australia, TEL: [03] 580-9911