

wo 9468

# Operating Instructions

CD CDV LD PLAYER

LaserDisc

# CLD-79

NTSC

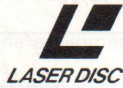

# ELITE

- This player is not suitable for commercial use.

Thank you for buying this Pioneer product. Please read through these operating instructions so you will know how to operate your model properly. After you have finished reading the instructions, put them away in a safe place for future reference. In some countries or regions, the shape of the power plug and power outlet may sometimes differ from that shown in the explanatory drawings. However, the method of connecting and operating the unit is the same.

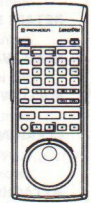
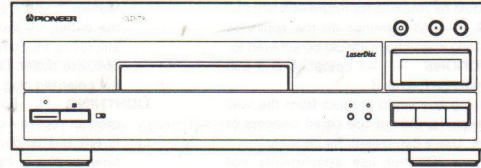

**WARNING : TO PREVENT FIRE OR SHOCK HAZARD, DO NOT EXPOSE THIS APPLIANCE TO RAIN OR MOISTURE.**

## IMPORTANT NOTICE

[For U.S. and Canadian models]

The serial number for this equipment is located on the rear panel. Please write this serial number on your enclosed warranty card and keep it in a secure area. This is for your security.

[For Canadian model]

**CAUTION :** TO PREVENT ELECTRIC SHOCK, DO NOT USE THIS (POLARIZED) PLUG WITH AN EXTENSION CORD, RECEPTACLE OR OTHER OUTLET UNLESS THE BLADES CAN BE FULLY INSERTED TO PREVENT BLADE EXPOSURE.

**ATTENTION:** POUR PREVENIR LES CHOCS ELECTRIQUES NE PAS UTILISER CETTE FICHE POLARISEE AVEC UN PROLONGATEUR, UNE PRISE DE COURANT OU UNE AUTRE SORTIE DE COURANT, SAUF SI LES LAMES PEUVENT ETRE INSEREES A FOND SANS EN LAISSER AUCUNE PARTIE A DECOUVERT.

**CAUTION:** This product satisfies FCC regulations when shielded cables and connectors are used to connect the unit to other equipment. To prevent electromagnetic interference with electric appliances such as radios and televisions, use shielded cables and connectors for connections.

## CONTENTS

### BEFORE OPERATING THE PLAYER

ACCESSORIES .....	4
PRECAUTIONS .....	5
FEATURES AND FUNCTIONS OF THE PLAYER .....	6
TYPES OF DISCS THAT CAN BE PLAYED WITH THIS UNIT ....	7
CARE OF DISCS .....	8
CONNECTIONS .....	9
BASIC CONNECTIONS .....	9
CONNECTING TO THE DIGITAL JACKS .....	10
SYSTEM REMOTE CONTROL CONNECTION .....	11
NAMES AND FUNCTIONS OF CONTROLS .....	12

### BASIC OPERATION

TO PLAY AN LD, CDV OR CD .....	14
--------------------------------	----

### VARIOUS OPERATION

PICTURE QUALITY ADJUSTMENT (V-DNR) .....	18
TO SEARCH FOR A PARTICULAR TIME/FRAME - Time Number Search/Track Time Search/ABS Time Search/ Frame Number Search .....	21
TO PLAY ALL CHAPTERS/TRACKS IN RANDOM ORDER - Random Playback .....	22
TO SEARCH FOR A PARTICULAR CHAPTER/TRACK - Hi-Lite Scan/Intro Scan .....	22
TO REPEATEDLY PLAY A DESIRED PASSAGE - Repeat Playback .....	23
TO PLAY ONLY DESIRED SCENES/TRACKS - Program Playback .....	24
DISPLAY SWITCHING .....	25
TRUBLESHOOTING .....	26
SPECIFICATIONS .....	29

## IMPORTANT



The lightning flash with arrowhead, within an equilateral triangle, is intended to alert the user to the presence of uninsulated "dangerous voltage" within the product's enclosure that may be of sufficient magnitude to constitute a risk of electric shock to persons.

**CAUTION**  
**RISK OF ELECTRIC SHOCK**  
**DO NOT OPEN**

**CAUTION:**  
**TO PREVENT THE RISK OF ELECTRIC SHOCK, DO NOT REMOVE COVER (OR BACK). NO USER-SERVICEABLE PARTS INSIDE. REFER SERVICING TO QUALIFIED SERVICE PERSONNEL.**



The exclamation point within an equilateral triangle is intended to alert the user to the presence of important operating and maintenance (servicing) instructions in the literature accompanying the appliance.

# SAFETY INSTRUCTIONS

**READ INSTRUCTIONS** — All the safety and operating instructions should be read before the appliance is operated.

**RETAIN INSTRUCTIONS** — The safety and operating instructions should be retained for future reference.

**HEED WARNINGS** — All warnings on the appliance and in the operating instructions should be adhered to.

**FOLLOW INSTRUCTIONS** — All operating and use instructions should be followed.

**CLEANING** — Unplug this video product from the wall outlet before cleaning. Do not use liquid cleaners or aerosol cleaners. Use a damp cloth for cleaning.

**ATTACHMENTS** — Do not use attachments not recommended by the video product manufacturer as they may cause hazards.

**WATER AND MOISTURE** — Do not use this video product near water — for example, near a bathtub, wash bowl, kitchen sink, or laundry tub, in a wet basement, or near a swimming pool, etc.

**ACCESSORIES** — Do not place this video product on an unstable cart, stand, tripod, bracket, or table. The video product may fall, causing serious injury to a child or adult, and serious damage to the appliance. Use only with a cart, stand, tripod, bracket, or table recommended by the manufacturer, or sold with the video product. Any mounting of the appliance should follow the manufacturer's instructions, and should use a mounting accessory recommended by the manufacturer.

**CART** — An appliance and cart combination should be moved with care. Quick stops, excessive force, and uneven surfaces may cause the appliance and cart combination to overturn.



**VENTILATION** — Slots and openings in the cabinet are provided for ventilation and to ensure reliable operation of the video product and to protect it from overheating. These openings must not be blocked or covered. They should never be blocked by placing the video product on a bed, sofa, rug, or other similar surface. This video product should never be placed near or over a radiator or heat register. This video product should not be placed in a built-in installation such as a bookcase or rack unless proper ventilation is provided or the manufacturer's instructions have been adhered to.

**POWER SOURCES** — This video product should be operated only from the type of power source indicated on the marking label. If you are not sure of the type of power supply to your home, consult your appliance dealer or local power company. For video products intended to operate from battery power, or other sources, refer to the operating instructions.

### POWER-CORD PROTECTION

Power-supply cords should be routed so that they are not likely to be walked on or pinched by items placed upon or against them. Pay particular attention to cords at plugs, convenience receptacles, and the point where they exit from the appliance.

**POLARIZATION** — This video product is equipped with a polarized alternating current line plug (a plug having one blade wider than the other). This plug will fit into the power outlet only one way. This is a safety feature. If you are unable to insert the plug fully into the outlet, try reversing the plug. If the plug should still fail to fit, contact your electrician to replace your obsolete outlet. Do not defeat the safety purpose of the polarized plug.

**LIGHTNING** — For added protection for this video product receiver during a lightning storm, or when it is left unattended and unused for long periods of time, unplug it from the wall outlet and disconnect the antenna or cable system. This will prevent damage to the video product due to lightning and power-line surges.

**POWER LINES** — An outside antenna system should not be located in the vicinity of overhead power lines or other electric light or power circuits, or where it can fall into such power lines or circuits. When installing an outside antenna system, extreme care should be taken to keep from touching such power lines or circuits as contact with them might be fatal.

**OVERLOADING** — Do not overload wall outlets and extension cords as this can result in the risk of fire or electric shock.

**OBJECT AND LIQUID ENTRY** — Never push objects of any kind into this video product through openings as they may touch dangerous voltage points or short-out parts that could result in a fire or electric shock. Never spill liquid of any kind on the video product.

**SERVICING** — Do not attempt to service this video product yourself as opening or removing covers may expose you to dangerous voltage or other hazards. Refer all servicing to qualified service personnel.

### DAMAGE REQUIRING SERVICE

Unplug this video product from the wall outlet and refer servicing to qualified service personnel under the following conditions:

- When the power-supply cord or plug is damaged.
- If liquid has been spilled, or objects have fallen into the video product.
- If the video product has been exposed to rain or water.
- If the video product does not operate normally by following the operating instructions. Adjust only those controls that are covered by the operating instructions. Improper adjustment of other controls may result in damage and will often require extensive work by a qualified technician to restore the video product to its normal operation.
- If the video product has been dropped or the cabinet has been damaged.
- If the video product exhibits a distinct change in performance — this indicates a need for service.

**REPLACEMENT PARTS** — When replacement parts are required, be sure the service technician has used replacement parts specified by the manufacturer or having the same characteristics as the original part. Unauthorized substitutions may result in fire, electric shock or other hazards.

**SAFETY CHECK** — Upon completion of any service or repairs to this video product, ask the service technician to perform safety checks to determine that the video product is in proper operating condition.

**OUTDOOR ANTENNA GROUNDING** — If an outside antenna is connected to the antenna terminal, be sure the antenna system is grounded so as to provide some protection against voltage surges and built-up static charges.

In the U.S.A. section 810 of the National Electrical Code, ANSI/NFPA 70, provides information with respect to proper grounding of the mast and supporting structure, grounding of the lead-in wire to an antenna discharge unit, size of grounding conductors, location of antenna-discharge unit, connection to grounding electrodes, and requirements for the grounding electrode.

See Fig. A.

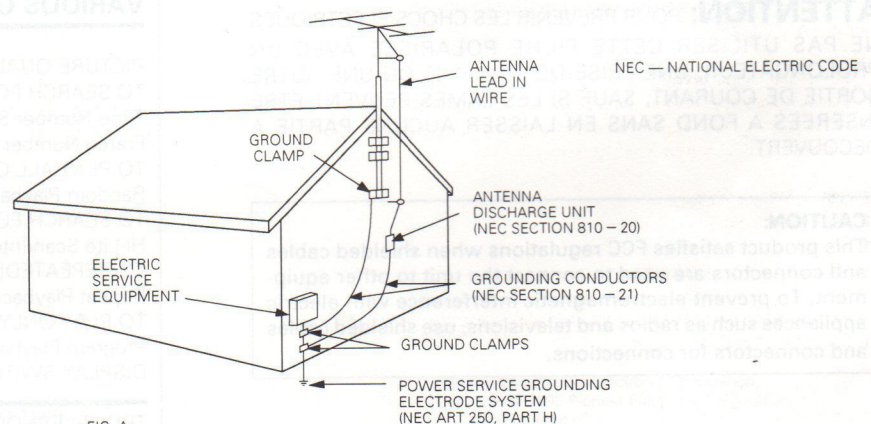

FIG. A

This equipment has been tested and found to comply with the limits for a Class B digital device, pursuant to Part 15 of the FCC Rules. These limits are designed to provide reasonable protection against harmful interference in a residential installation. This equipment generates, uses, and can radiate radio frequency energy and, if not installed and used in accordance with the instructions, may cause harmful interference to radio communications. However, there is no guarantee that interference will not occur in a particular installation. If this equipment does cause harmful interference to radio or television reception, which can be determined by turning the equipment off and on, the user is encouraged to try to correct the interference by one or more of the following measures:

- Reorient or relocate the receiving antenna.
- Increase the separation between the equipment and receiver.
- Connect the equipment into an outlet on a circuit different from that to which the receiver is connected.
- Consult the dealer or an experienced radio/TV technician for help.

#### Information to User

Alteration or modifications carried out without appropriate authorization may invalidate the user's right to operate the equipment.

#### CAUTION

- Use of controls or adjustments or performance of procedures other than those specified herein may result in hazardous radiation exposure.
- The use optical instruments with this product will increase eye hazard.

#### [For Canadian model]

This Class B digital apparatus meets all requirements of the Canadian Interference-Causing Equipment Regulation.

#### [Pour le modèle Canadien]

Cet appareil numérique de la Classe B respecte toutes les exigences du Règlement sur le matériel brouilleur du Canada.



### Dear Customer:

Selecting fine audio equipment such as the unit you've just purchased is only the start of your musical enjoyment. Now it's time to consider how you can maximize the fun and excitement your equipment offers. This manufacturer and the Electronic Industries Association's Consumer Electronics Group want you to get the most out of your equipment by playing it at a safe level. One that lets the sound come through loud and clear without annoying blaring or distortion-and, most importantly, without affecting your sensitive hearing.

Sound can be deceiving. Over time your hearing "comfort level" adapts to higher volumes of sound. So what sounds "normal" can actually be loud and harmful to your hearing. Guard against this by setting your equipment at a safe level BEFORE your hearing adapts.

#### To establish a safe level:

- Start your volume control at a low setting.
- Slowly increase the sound until you can hear it comfortably and clearly, and without distortion.

#### Once you have established a comfortable sound level:

- Set the dial and leave it there.

Taking a minute to do this now will help to prevent hearing damage or loss in the future. After all, we want you listening for a lifetime.

## We Want You Listening For A Lifetime

Used wisely, your new sound equipment will provide a lifetime of fun and enjoyment. Since hearing damage from loud noise is often undetectable until it is too late, this manufacturer and the Electronic Industries Association's Consumer Electronics Group recommend you avoid prolonged exposure to excessive noise. This list of sound levels is included for your protection.

#### Decibel

Level	Example
30	Quiet library, soft whispers
40	Living room, refrigerator, bedroom away from traffic
50	Light traffic, normal conversation, quiet office
60	Air conditioner at 20 feet, sewing machine
70	Vacuum cleaner, hair dryer, noisy restaurant
80	Average city traffic, garbage disposals, alarm clock at two feet.

#### THE FOLLOWING NOISES CAN BE DANGEROUS UNDER CONSTANT EXPOSURE

90	Subway, motorcycle, truck traffic, lawn mower
100	Garbage truck, chain saw, pneumatic drill
120	Rock band concert in front of speakers, thunderclap
140	Gunshot blast, jet plane
180	Rocket launching pad

Information courtesy of the Deafness Research Foundation.



## ACCESSORIES

When unpacking the player, first check to make sure that all of the accessories listed below are supplied:

- Remote control unit
- Size "AAA" (IEC R03) dry cell battery x 2

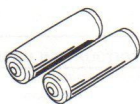

- Video cord (Pin plug ↔ Pin plug)  
Use to connect the player to a color monitor, etc.

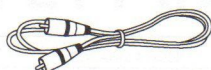

- S-VIDEO cable (Mini DIN ↔ Mini DIN)

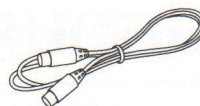

- Audio cord (Pin plug x 2 ↔ Pin plug x 2)  
Use to connect the player to a stereo amplifier, etc.



- Operating instructions
- Warranty card

### INSERTING BATTERIES INTO THE REMOTE CONTROL UNIT

- 1 Open the battery compartment cover on the back of the remote control unit. Press the knob and open the cover in the direction of the arrow.
- 2 Take out the two accessory size "AAA" (IEC R03) dry cell batteries, and insert them into the battery compartment in accordance with the display (+, -) inside the compartment.
- 3 Close the cover of the battery case.

Incorrect use of batteries may lead to leakage or rupture. Always be sure to follow these guidelines:

- A. Always insert batteries into the battery compartment, correctly matching the positive (+) and negative (-) polarities, as indicated inside the compartment.
- B. Never mix new and used batteries.
- C. Batteries of the same size may have different voltages, depending on their type. Do not mix different types of batteries.

### Range of remote control operation

When operating the remote control unit, point the unit's infrared signal transmitter at the remote control unit receiver on the front panel of the player. The remote control unit can be used within a range of about 7 meters (23feet) from the remote sensor, and within angles of up to about 30 degrees.

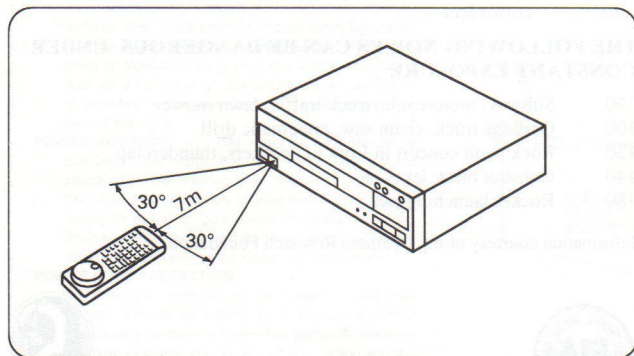

1

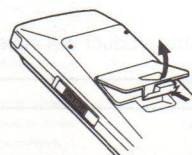

2

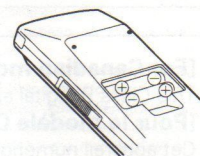

3

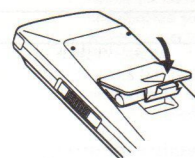

### NOTES FOR USING THE REMOTE CONTROL UNIT

- If a plug is connected to the CONTROL IN terminal at the rear of the player, remote control operations cannot be done with the remote control unit aimed at the player's remote control sensor. Aim the remote control unit at the AV amplifier or the component display's sensor instead.
- If there is any obstacle between the remote control unit and the player, or if the unit is held at too large an angle relative to the front panel of the player, the signal from the remote control unit will fail to reach the remote sensor.
- If the player is operating in the vicinity of other appliances generating infrared rays, or if other remote control devices using infrared rays are used near the player, the player may operate improperly. Conversely, if the player's remote control unit is operated in the vicinity of other appliances which use an infrared remote control device, the other appliance may operate improperly. If this should happen, change the place of installation so that improper operation does not occur.
- If the range of operation of the remote control unit becomes too short, replace the batteries.
- When the unit is not to be used for a long period of time (more than one month), remove the batteries to prevent them from leaking inside the compartment. If leakage occurs, wipe up the liquid inside the compartment and replace the batteries with new ones.
- Do not place books or other objects on the remote control unit, since they might depress the buttons and run down the batteries.
- If the remote control sensor window is in a position where it receives strong light such as sunlight or fluorescent light, control may not be possible.

## PRECAUTIONS

**If it becomes necessary to transport or ship this unit in the future, be sure to first remove the disc (if loaded), retract the disc table to its closed position and turn the power off. After the "OFF" display goes out on the display, disconnect the power cord.**

### INSTALLING THE PLAYER

- Place the player on a stable platform next to the television and stereo system to be used with the player.
- When using the player with a stereo system, your speakers should be placed away from your television (or TV monitor).
- Do not place heavy objects such as a television or TV monitor on top of the player.
- Do not place the player on top of your TV set or TV monitor. Also, keep the player away from devices such as cassette decks which are sensitive to magnetic fields.

When FM or AM stations are being received, signal noise may be generated if the player is turned on. Turn off the player when not in use. Also, if there is a signal noise when receiving radio stations with an indoor antenna, adjust the position or direction of the antenna.

### INSTALL THE PLAYER IN A WELL VENTILATED PLACE AWAY FROM HEAT AND HUMIDITY

Do not install the player in a location subject to direct sunlight, or near a stove or radiator, etc. This could adversely affect the cabinet and internal components. Also avoid installing the player in a humid or dusty location. This could result in a malfunction or accident. Do not install near a cookstove where the player could be affected by smoke, steam, or heat.

### AVOID SOURCES OF HEAT

Do not put the player on sources of heat, such as an amplifier. When installing with audio components on a rack, avoid components that generate heat, by placing the player below such components where there is adequate ventilation and not much dust. Avoid placing the player on surfaces such as shaggy carpets, beds, and sofas which may block ventilation under the player and cause damage.

### CAUTIONS FOR AUTOMATIC LOADING OPERATIONS

Since this player has an automatic loading construction, use the button on the player or the remote control unit for opening and closing of the disc table. To avoid damage, be careful not to apply any force to the moving disc table.

Even when the player is in the pause mode, the disc-drive motor is still revolving. Since leaving the player in this condition can shorten the lifetime of the motor, do not leave the player in the pause mode for a long period of time. Also, to prevent the damage to the screen, do not use the unit for a long period of time under conditions in which the screen display (monitor) has been displayed characters (for example, power-ON mode, CD PLAY, PAUSE).

### CAUTION WHEN INSTALLING IN A RACK HAVING A GLASS DOOR

Be careful to install so that when the disc table is opened by remote control it does not hit the glass door. Strong force against movement of the disc table may cause breakdown.

### Take the following precautions to avoid accidents!

Be careful not to catch your finger in the disc table section while the disc table is being retracted into the unit. Also, be careful that children do not put their hands inside the unit while the disc table is open. This may cause injury.

### STRIPE PATTERNS APPEARING ON A TV PROGRAM

Stripe patterns may appear during a TV program if the player unit is turned on, depending on the quality of reception of the TV station. This is neither a malfunction of the television nor the player. If stripes appear while watching TV, or when watching TV for a long period of time, turn the player off.

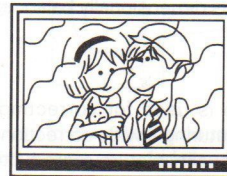

### CONDENSATION

Moisture will form in the operating section of the player if the player is brought from cool surroundings into a warm room or if the temperature of the room rises suddenly. When this happens, player's performance will be impaired.

To prevent this, let the player stand in its new surroundings for about an hour before switching it on, or make sure that the room temperature rises gradually.

The same symptoms of condensation may be caused during summer, if the player is exposed to the breeze from an air conditioner. In such cases, change the location of the player.

### POWER-CORD CAUTION

Handle the power cord by the plug. Do not pull out the plug by tugging the cord and never touch the power cord when your hands are wet as this could cause a short circuit or electric shock. Do not place the unit, a piece of furniture, etc., on the power cord, or pinch the cord. Never make a knot in the cord or tie it with other cords. The power cords should be routed such that they are not likely to be stepped on. A damaged power cord can cause fire or give you an electrical shock. Check the power cord once in a while. When you find it damaged, ask your nearest PIONEER authorized service center or your dealer for a replacement.

### CLEANING CARE

Use a soft, dry cloth for cleaning. For stubborn dirt, soak the cloth in a solution of household detergent diluted using one part detergent to five or six parts water; wring well first and wipe. Use a dry cloth to wipe it dry. Do not use any volatile agents such as benzine or paint thinner, as they may damage the surface of the player.

**Abnormal functioning of this unit may be caused by static electricity, or other external interference. To restore normal operation, turn the power off and then on again, or unplug the AC power cord and then plug it in again.**

Only one disc can be loaded at any one time. Loading a LaserVision Disc, a Compact Disc, an 8-cm Compact Disc or a Compact Disc with Video on top of one another may result in breakdown, or in scratching of the discs.

Please only load one disc at a time.

This player is to be used exclusively with the NTSC color system. Please use NTSC LaserVision Disc or NTSC Compact Disc with Video only. PAL and SECAM system discs cannot be used with this player.

## FEATURES AND FUNCTIONS OF THE PLAYER

### Gamma-Turn System - Two-Side Continuous Playback

With this function, both sides of a two-sided LD can be played consecutively, eliminating the need to turn the disc over when the first side is completed.

### A Side ↔ B Side Continuous Playback Programs

Through the use of the Gamma-Turn system, programs which go from side A to side B or from side B to side A can be freely created.

### Full Digital Processing System

Virtual elimination of analog processing assures high picture quality with minimal distortion. Thanks to the field correlation digital video processor, the picture is dimensionally balanced with high resolution and high S/N.

### Digital TBC system

A digital TBC system is used for correcting jitter in the picture processing circuitry, featuring a wide correction range, minimal signal degradation and high-quality picture reproduction.

### 3-Line Digital Y/C Separation Circuitry

Video signals pass through the Y/C circuitry prior to being output through the S output terminal, thereby reducing cross color interference and dot noise that appear on the color border of the picture. This realizes a high quality picture for you to enjoy.

### 1-Bit DLC D/A Converters

D/A converters are devices for transforming digital signals into analog signals. The D/A converter used in this player employs an advanced 1-bit conversion system. Compared to conventional converters, this system has the following advantages:

- Theoretically no zero cross distortion is generated.
- The system is free of non-linear distortion throughout the frequency range.
- High-precision operation can be obtained without adjustments.

With this type of conversion, there is no loss of music quality even at minute signal levels. Moreover, the noise shaping function necessary for 1-bit conversion is implemented using a double-step noise shaping system. This system carries out noise shaping once in the preliminary digital filter stage and then again in the D/A converter section, thus minimizing quantization noise and providing extremely high-precision. Furthermore, this D/A converter is used independently for the left and right channels, realizing a high signal-to-noise ratio and excellent separation.

### Legato Link Conversion

This unit is equipped with Legato Link Conversion which makes possible reproduction that exceeds the conventional limits of the digital recording format.

Legato Link Conversion achieves music reproduction closer to the original sound by deducing the original signal based on the recorded signal.

### Picture Stop Cancel (PSC) function

### Digital output terminals

This unit is equipped with both optical output and coaxial digital output terminals.

### Digital NR

LDs contain inherent noise such as color smearing. To effectively reduce this kind of noise, this unit features Digital NR. You can also independently adjust brightness and color. Naturally, since processing is digital, there's no loss in picture quality.

### Film Mode

When Film Mode is ON, the front panel display window and screen display are turned off during playback, and the screen goes black when changing disc sides. Play starting time and the time required to change disc sides is shorter than during normal playback of movie discs.

### Program Playback

Up to 24 chapters can be programmed for playback in any desired sequence.

### Repeat Playback

Eight repeat modes - Memory Repeat, A-B Repeat, 1-chapter/track Repeat, One-side Repeat, All side Repeat (for two-side LDs only), Program Repeat, and Random Repeat - are available. (With discs having no TOC, Random Repeat cannot be carried out.)

### Special Play Functions

Thanks to the video circuitry's 8-bit digital memory, you can enjoy a high quality picture and a range of different play modes even with a long-playing disc (CLV).

### Random Playback (For LDs, this function is only available with discs containing TOC.)

All chapters of one side of a disc can be played in random order.

### Hi-Lite/Intro Scan Playback

#### Hi-Lite Scan - CD, CDV-audio part

Playback starts from a point 1 minute after the beginning of the track, and each track is played for about 8 seconds. Also, Hi-Lite Scan playback can be started from the desired minute and second on each track.

#### Intro Scan - LD, CDV-video part

The beginning of each chapter/track is played for about 8 seconds.

### Direct CD Function

Pressing DIRECT CD on the front panel instructs the unit to use the CD disc table, which reduces the play starting time. In addition, since the picture circuit does not function, the player eliminates the interference between signals and reproduces more pure sound.

### Last Memory Function

This lets you watch a LD part way through, and then resume watching it later from where you left off.

### Compatibility with Many Disc Types and Sizes





In addition to conventional LDs (12 inch, 8 inch), CDs (5 inch), and CDV discs (5 inch), the player can play thin-type 8 inch LDs and 3 inch CD singles without an adapter.

# TYPES OF DISCS THAT CAN BE PLAYED WITH THIS UNIT

This unit is a CD VIDEO SYSTEM compatible player which can play CDs, CDV discs, and LDs.

- The marks shown in the right column are printed on the labels and jackets of the corresponding discs.

This player can play the following seven types of discs without using an adapter:

<p><b>CD Single (one-side recording)</b></p> <p>8 cm (3 in.)</p> <p>Digital audio (max. 20 min.)</p>	
<p><b>CD (one-side recording)</b></p> <p>12 cm (5 in.)</p> <p>Digital audio (max. 74 min.)</p>	
<p><b>CDV (one-side recording)</b></p> <p>12 cm (5 in.)</p> <p>Digital audio (max. 20 min.) (Audio part)</p> <p>Digital audio + Video (max. 5 min.) (Video part)</p>	
<p><b>VSD (Video Single Disc) (one-side recording)</b></p> <p>12 cm (5 in.)</p> <p>Digital audio + Video (max. 5 min.)</p>	
<p>● In the operating instructions in this manual, the VSD is treated as a kind of CDV.</p>	
<p><b>LD Single (one-side recording)</b></p> <p>20 cm (8 in.)</p> <p>Digital/analog audio + Video (CAV: max. 14 min. CLV: max. 20 min.)</p>	
<p><b>LD (two-side or one-side recording)</b></p> <p>20 cm (8 in.)</p> <p>Digital/analog audio + Video (CAV: max. 14 min. per side CLV: max. 20 min. per side)</p>	
<p><b>LD (two-side or one-side recording)</b></p> <p>30 cm (12 in.)</p> <p>Digital/analog audio + Video (CAV: max. 30 min. per side CLV: max. 60 min. per side)</p>	

Discs other than those noted above cannot be played back with this player. (i.e., Video CD, CD-ROM, LD-ROM, Hi-Vision LD, etc.)

## HOW TO PLACE A DISC

Place the disc in the correct position by using the appropriate disc guide groove.

LD disc table:

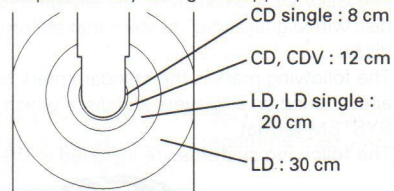

CD disc table:

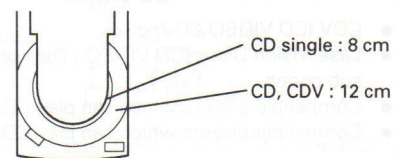

## LD GLOSSARY

### Chapter number

Chapter numbers are used to indicate the boundaries of the sections on a disc. If chapter numbers are recorded on a disc, it is also indicated on the jacket of the disc, etc.

### Frame number

Frame numbers are the numbers assigned to each picture frame on a CAV disc.

### Time number

Time numbers indicate the time elapsed from the beginning of a CLV disc.

## CDV/CD GLOSSARY

### Track number

Track numbers indicate the boundaries of the sections, or "tracks", on a disc. Track numbers are assigned consistently throughout the audio part and video part of a CDV disc.

## TOC

The TOC (Table of Contents) section is just like the table of contents of a book, and contains information on the contents (number of tracks, playing time, etc.) of the disc.



- Some LD discs are not provided with a TOC section.

\* This is the unified symbol mark of LASERDISC (LaserVision videodisc).



LaserDisc players and discs which bear this symbol and use the same television system, are mutually compatible.

\*\* A Digital Audio with Multi Audio Disc (CD VIDEO LD) and a CDV (CD Video CDV) are referred to as CD Video discs. CD Videodiscs are recorded with subcodes, which are the non-audio recordings of TOC (Table of Contents) data such as track numbers, index numbers, etc. However, there are some discs without these marks.

## CD VIDEO SYSTEM

- There are some discs marked with the  mark instead of the  mark.
- There are some disc without the  mark.

### CAUTION

Video CDs  or  cannot be played.

(Video CD is a digital audio/video recording in MPEG format, up to 74 minutes long.)

## TYPES OF DISCS THAT CAN BE PLAYED WITH THIS UNIT

### CD VIDEO SYSTEM

The CD VIDEO SYSTEM is the standard name for the "optical video disc with digital audio" system that encompasses both LDs and CDV discs.

The following mark is the standard mark for the CD VIDEO SYSTEM and is found on all players and discs which conform to the CD VIDEO SYSTEM format.

The following systems are included in the CD VIDEO SYSTEM:



- CDV (CD VIDEO CDV) discs
- LaserVision Discs (CD VIDEO LDs) containing digital audio with sub codes.
- Compatible players which can play CDs and CDV discs.
- Compatible players which can play CDs, CDV discs, and LDs.

### CD VIDEO LDs

A CD VIDEO LD is an LD with digital audio which is encoded with sub codes (data such as TOC and track number data, excluding audio and video signals).

### LDs (LASERDISCS)

Two types of standard LaserDisc are available — standard play (CAV) disc and extended play (CLV) discs — which differ with respect to their signal recording systems.

### CAV DISCS

The jackets and labels of these discs are marked with a "Standard Play Disc CAV" or "Standard Play" indication.

### CLV DISCS

The jackets and labels of these discs are marked with "Extended Play Disc CLV" or "Extended Play" indication.

### LASERVISION DISCS WITH DIGITAL AUDIO

The jackets and labels of these discs bear the following mark.

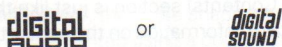

or



These are LaserDiscs which contain digital audio signals in addition to conventional analog audio signals. This feature allows the high image quality of LaserDiscs to be enjoyed together with the superior quality of digital audio.

### LASERVISION MULTI AUDIO DISCS WITH DIGITAL AUDIO

The jackets and labels of these discs bear the following mark.

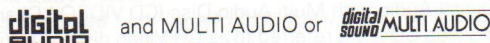

These are LaserDiscs in which the recorded digital and analog audio signals differ in content. This allows the user to enjoy two different audio soundtracks by switching between the digital and analog audio.

### CDV (COMPACT DISC WITH VIDEO) DISCS

These are compact discs which also contain video signals. Of the total 25-minute playback time of a CDV disc, 20 minutes are encoded with conventional CD digital audio signals (the "audio part"). The remaining 5 minutes are encoded with both video and digital audio signals (the "video part").

In normal playback mode, the unit plays the audio part after the video part is played back.

## CARE OF DISCS

### How to hold discs

When loading or removing discs, try not to touch their playing surfaces.



### Cleaning

Fingerprints or other dirt on the disc may affect sound and picture quality.

To clean your discs, use a soft clean cloth to wipe them. If necessary, moisten a soft cloth with diluted neutral detergent to remove heavy dirt or fingerprints.



Do not wipe in a circular direction.  
(Concentric scratches in the disc groove tend to cause noise.)

Gently wipe from the inside toward the outer edge.

Discs must not be cleaned with record cleaning sprays, or static prevention sprays, etc. Also, do not use volatile liquids such as benzene, or thinner, etc.

### NEVER PLAY CRACKED OR WARPED DISCS

- The disc revolves in the player at a high speed when it is played. Never play a cracked, scratched or warped disc. This may damage the player or cause it to malfunction.

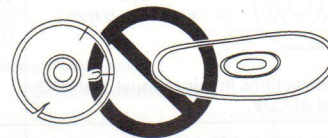

### After using discs, store them upright

After playing a disc, always remove it from the player and return it to its jacket. Then store it standing upright away from heat and humidity.

- Store discs carefully. If you store discs at an angle, or stacked on top of each other, discs may become warped even when in their jackets.
- Do not leave discs in locations such as the seat of car, which may become excessively hot.

### CAUTION WHEN USING THE DISC

All rights reserved.

Unauthorized public performance, broadcasting or copying is a violation of applicable laws.



# CONNECTIONS

## BASIC CONNECTIONS

- Use an AV TV with video/audio inputs (or a monitor TV).

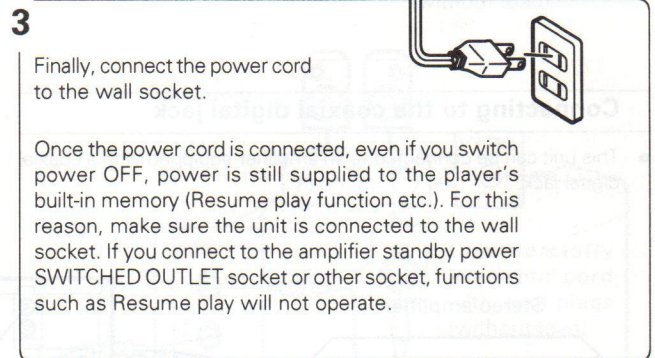
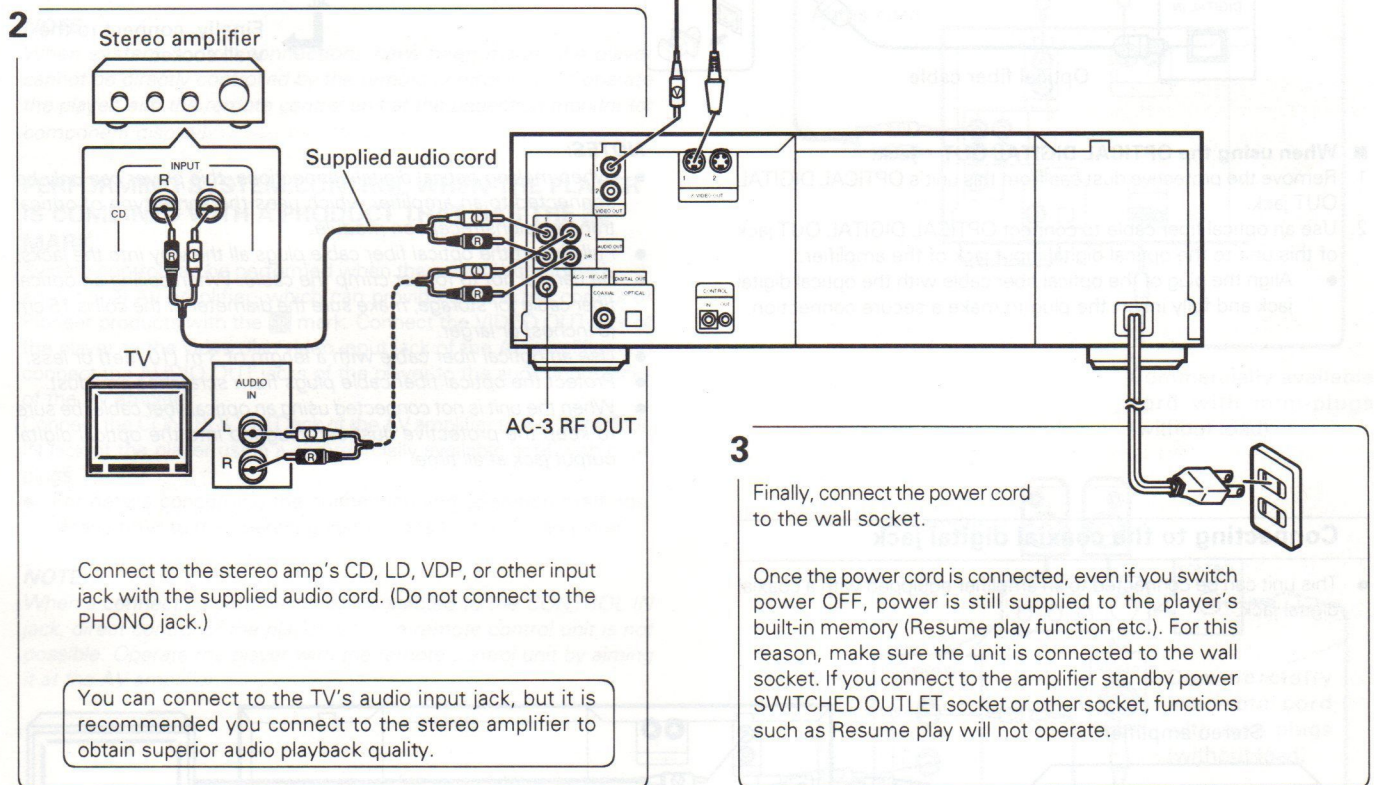
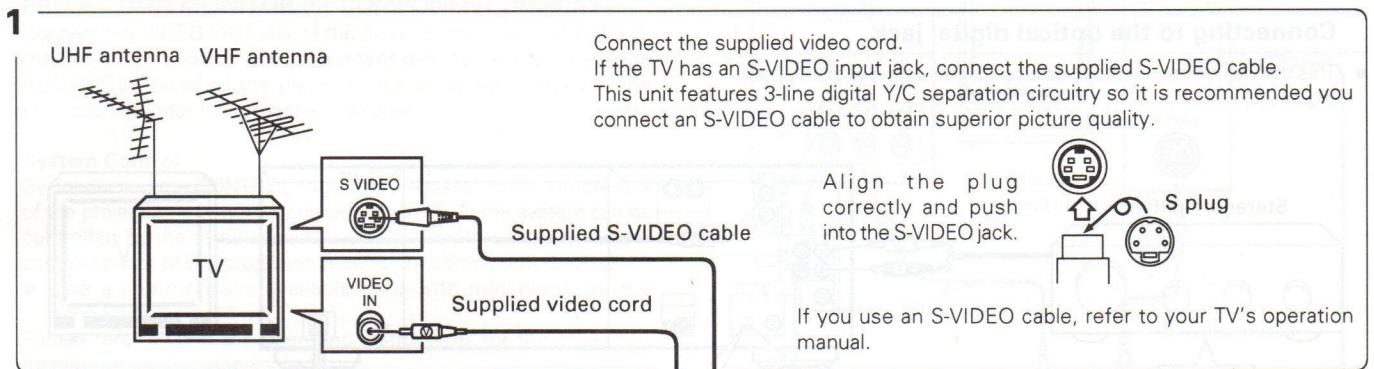

### These connections are also possible

- If you have a stereo amplifier with optical or coaxial inputs, refer to page 10. Connection to this unit's digital output (optical or coaxial) is possible.
- If you have a Pioneer projection monitor, refer to page 11. You can connect to this unit's control jack for system remote control.
- If you have an AV amplifier bearing the Pioneer mark, refer to page 11. You can connect to this unit's control jack for system remote control.

### AC-3 RF OUT terminal:

This terminal is intended for use with Dolby AC-3\* components (\*1) planned for future release. With this terminal, you will be able to connect an AC-3 RF input of amplifiers and surround processors, and playback LDs formatted with Dolby AC-3 (\*2).

(\*1) Indicated with (For hardware)

(\*2) Indicated with (For software)

- You cannot playback currently available LDs, LD players, AV amplifiers, etc., with this terminal.
- Do not connect this terminals to the audio input terminal of a normal stereo or AV amplifiers.

\* "Dolby", "AC-3" and the double-D symbol are trademarks of Dolby Laboratories Licensing Corporation.

## CONNECTIONS

### CONNECTING TO THE DIGITAL JACKS

The optical fiber cable and coaxial cable are not supplied with this unit. Use a separately sold optical fiber cable or coaxial cable for the digital jack connections.

#### Connecting to the optical digital jack

- This unit can be connected to an amplifier equipped with an optical digital jack.

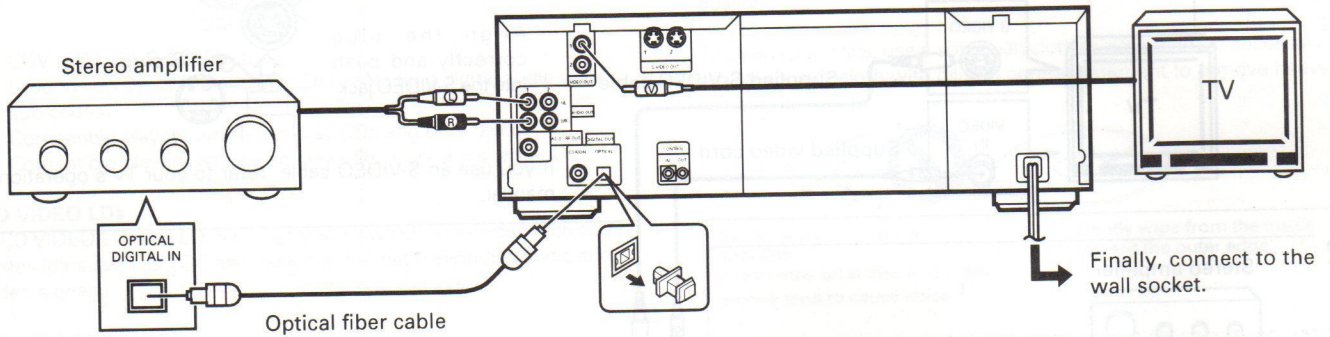

#### ■ When using the OPTICAL DIGITAL OUT jack:

1. Remove the protective dust cap from this unit's OPTICAL DIGITAL OUT jack.
2. Use an optical fiber cable to connect OPTICAL DIGITAL OUT jack of this unit to the optical digital input jack of the amplifier.
  - Align the plug of the optical fiber cable with the optical digital jack and fully insert the plug to make a secure connection.

#### NOTES:

- When making optical digital connections, this player can only be connected to an amplifier which uses the same type of optical transmissions/reception module.
- Fully insert the optical fiber cable plugs all the way into the jacks.
- Be careful not to fold or crimp the cable. When coiling an optical fiber cable for storage, make sure the diameter of the coil is 15 cm (6 inches) or larger.
- Use an optical fiber cable with a length of 3 m (10 feet) or less.
- Protect the optical fiber cable plugs from scratches and dust.
- When the unit is not connected using an optical fiber cable, be sure to keep the protective dust cap plugged into the optical digital output jack at all time.

#### Connecting to the coaxial digital jack

- This unit can be connected to an amplifier equipped with a coaxial digital jack.

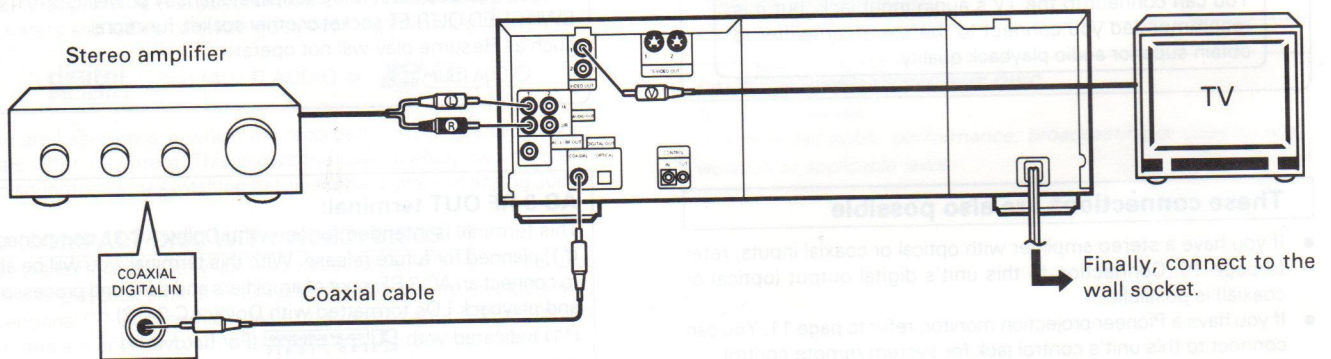

**SYSTEM REMOTE CONTROL CONNECTION**

**WHEN COMBINED WITH OPTIONAL PIONEER PROJECTION MONITOR (or COMPONENT DISPLAY)**

Connect the VIDEO OUT jack of the player to the video input jack of the projection monitor (or component display), and connect the AUDIO OUT jacks of the player to the audio input jacks of the projection monitor (or component display).

**System Control**

By connecting the CONTROL IN jack of the player to the remote jack of the projection monitor (or component display), the system can be controlled by the remote control unit of the player at the remote control sensor of the projection monitor (or component display).

- Use a commercially available cord with mini-plugs for the connection.

Please refer also to the operating instructions for the projection monitor (or component display).

**NOTE:**

When system control connections have been made, the player cannot be directly controlled by the remote control unit. To operate the player, aim the remote control unit at the projection monitor (or component display).

**PERFORMING SYSTEM CONTROL WHEN THE PLAYER IS COMBINED WITH A PRODUCT THAT HAS THE SR MARK**

System control can be performed when the player is combined with an optional AV amplifier, which can provide centralized control of Pioneer products with the SR mark. Connect the VIDEO OUT jack of the player to the video disc video input jack of the AV amplifier and connect the AUDIO OUT jacks of the player to the audio input jacks of the AV amplifier.

Connect the CONTROL OUT jack of the AV amplifier to the CONTROL IN jack of the player using a commercially available cord with mini-plugs.

- For details concerning the connection and operation methods, please refer to the operating instructions for the AV amplifier.

**NOTE:**

When a connecting cord has been connected to the CONTROL IN jack, direct control of the player with the remote control unit is not possible. Operate the player with the remote control unit by aiming it at the AV amplifier.

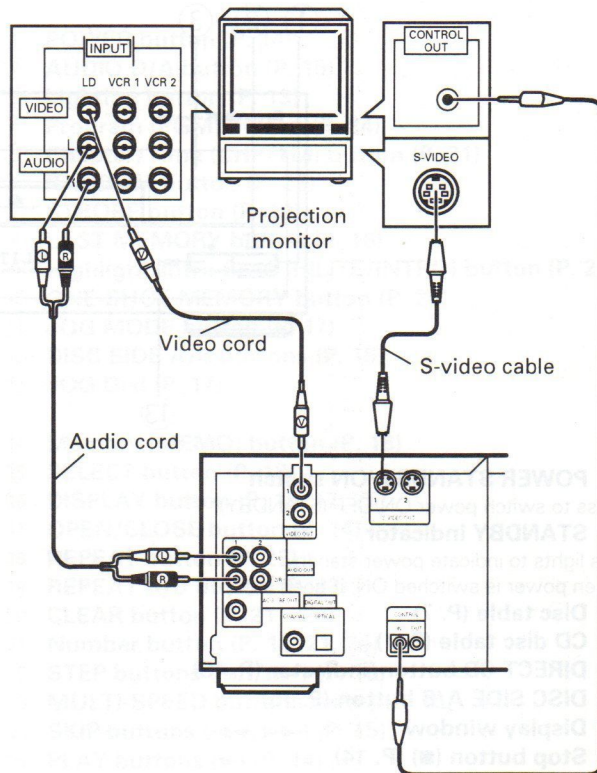

Commercially available cord with mini-plugs (without load)

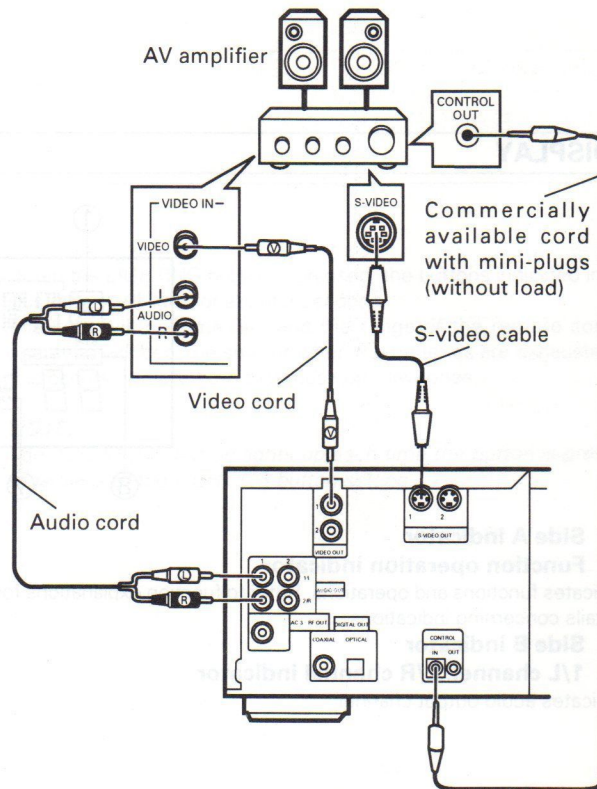

Commercially available cord with mini-plugs (without load)

# NAMES AND FUNCTIONS OF CONTROLS

## FRONT PANEL

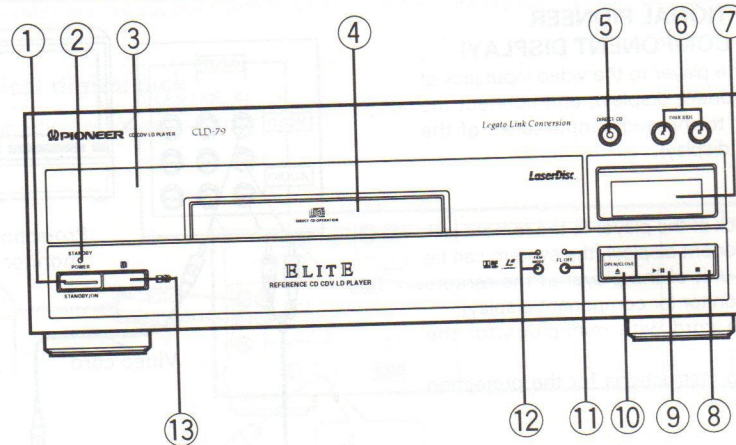

**① POWER STANDBY/ON switch**

Press to switch power ON/OFF (STANDBY).

**② STANDBY indicator**

This lights to indicate power standby. When power is switched ON, it goes out.

**③ Disc table (P. 7)**

**④ CD disc table (P. 7)**

**⑤ DIRECT CD button/indicator (P. 15)**

**⑥ DISC SIDE A/B button (P. 15)**

**⑦ Display window**

**⑧ Stop button (■) (P. 14)**

**⑨ Play/Pause button (▶/||) (P. 14)**

Press when power is OFF, and if there is a disc in the table, power is switched on and play starts.

**⑩ OPEN/CLOSE button (▲) (P. 14)**

Press when power is OFF, and power is switched ON and the disc table opens.

**⑪ FL OFF display button/indicator**

When you press the button, the indicator on top of the button lights and the display window switches OFF. Switching off the display prevents low level noise from adversely affecting sound quality. Press again to switch the display ON.

**⑫ FILM MODE button/indicator (P. 19)**

Switch ON if desired when watching a movie disc. When you switch it ON:

- The display window turns OFF. You can switch it ON/OFF with the FL OFF display button ⑪.
- Screen display (refer to P. 25 for display indications) switches OFF.
- When changing disc sides, the picture is usually the memorized picture, but when using the Film mode, the screen is black.

**⑬ Remote control sensor (P. 4)**

## DISPLAY

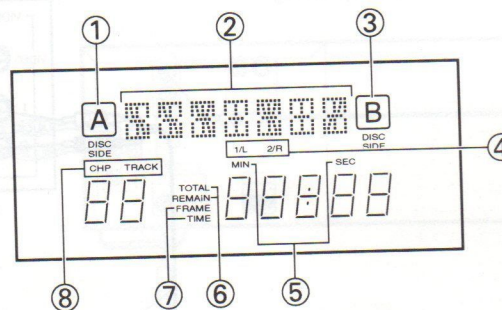

**① Side A indicator**

**② Function operation indicator**

Indicates functions and operations. Refer to function explanations for details concerning indications.

**③ Side B indicator**

**④ 1/L channel, 2/R channel indicator**

Indicates audio output channel.

**⑤ MIN/SEC indicator**

Indicates play time in minutes and seconds.

**⑥ TOTAL/REMAIN indicator**

Indicates remaining play time (REMAIN) and the total play time of the side (TOTAL).

**⑦ FRAME/TIME indicator**

Indicates frame number and elapsed play time.

**⑧ Chapter/Track indicator**

Indicates chapter number and track number.

REMOTE CONTROL

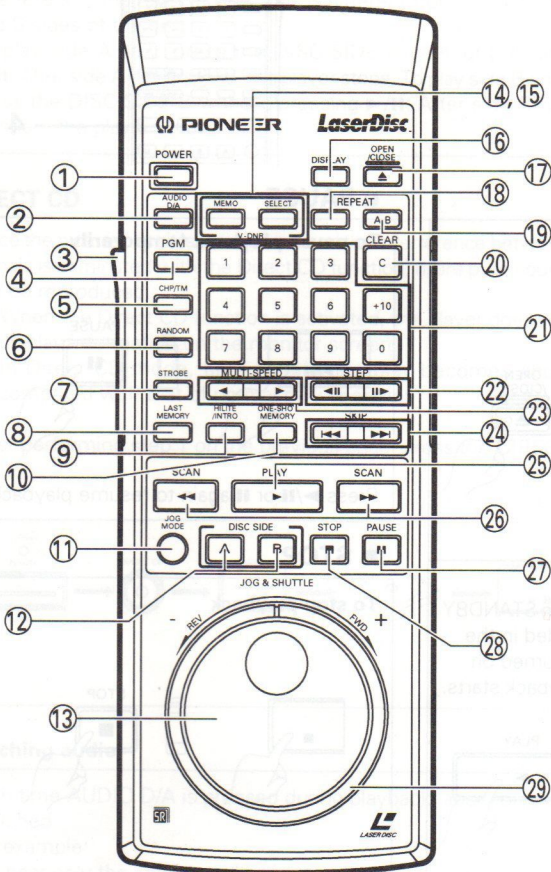

- ① POWER button (P. 14)
- ② AUDIO D/A button (P. 15)
- ③ Lighting button (P. 13)
- ④ Program (PGM) button (P. 24)
- ⑤ Chapter/Time (CHP/TM) button (P. 21)
- ⑥ RANDOM button (P. 22)
- ⑦ STROBE button (P. 19)
- ⑧ LAST MEMORY button (P. 16)
- ⑨ Highlight/Intro Scan (HILITE/INTRO) button (P. 22)
- ⑩ ONE-SHOT MEMORY button (P. 20)
- ⑪ JOG MODE button (P. 17)
- ⑫ DISC SIDE A/B buttons (P. 15)
- ⑬ JOG Dial (P. 17)
  
- ⑭ Memory (MEMO) button (P. 18)
- ⑮ SELECT button (P. 18)
- ⑯ DISPLAY button (P. 15, 17, 25)
- ⑰ OPEN/CLOSE button (P. 14)
- ⑱ REPEAT button (P. 23)
- ⑲ REPEAT A/B button (P. 23)
- ⑳ CLEAR button (P. 21 - 24)
- ㉑ Number button (P. 14, 21, 24)
- ㉒ STEP buttons (◀||/||▶) (P. 16)
- ㉓ MULTI-SPEED buttons (◀/▶) (P. 16)
- ㉔ SKIP buttons (◀◀/▶▶) (P. 15)
- ㉕ PLAY buttons (▶) (P. 14)
- ㉖ SCAN buttons (◀◀/▶▶) (P. 17)
- ㉗ PAUSE button (||) (P. 14)
- ㉘ STOP button (■) (P. 14)
- ㉙ SHUTTLE ring (P. 17, 18)

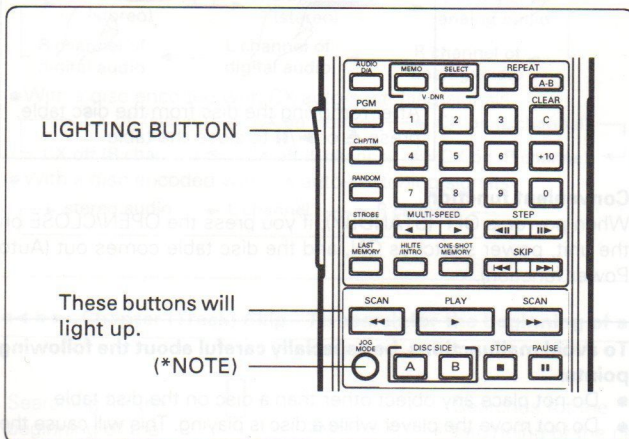

When the LIGHTING button is pressed, the buttons indicated in the illustration will light for about 3 seconds. The light will become dim and the range of the remote control operation will become shorter when the batteries are exhausted. If this occurs, replace both batteries with new ones.

**NOTE:**  
The JOG MODE button lights up each time the button is pressed regardless of the LIGHTING button setting.

# TO PLAY AN LD, CDV OR CD

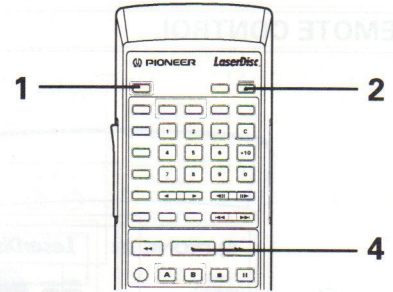
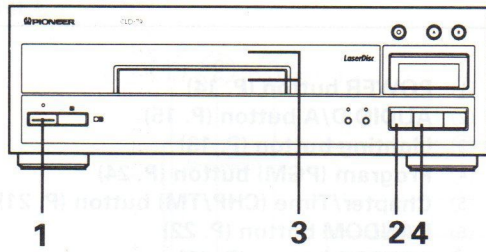

Operations indicated by [ ] mark are performed with the remote control unit.

## 1. Turn on the power of this unit.

If on the front panel is pressed in the STANDBY mode, the power is automatically turned on and the disc table is opened.

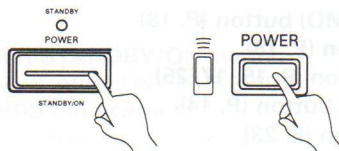

## 2. Open the disc table.



## 3. Place a disc along the proper disc guide groove.

CD/CDV : With the labeled side up.  
LD : With the desired side's label up.

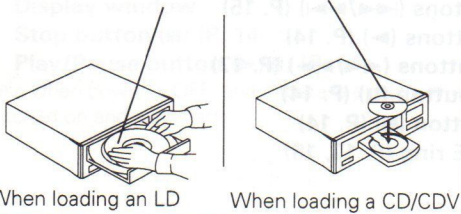

## 4. Start playback.

- When is pressed in STANDBY mode with a disc loaded in the player, the power is turned on automatically and playback starts.

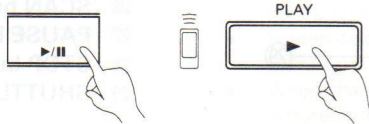

## II PAUSE

### To pause playback temporarily

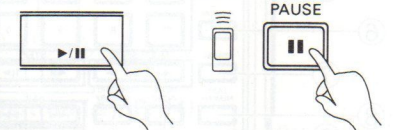

Press again to resume playback.

## ■ STOP

### To stop playback

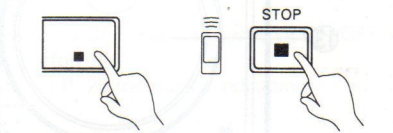

## ▲ OPEN/CLOSE

### To stop playback and take out the disc

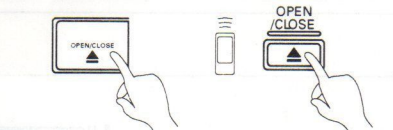

After removing the disc from the disc table, press or to close the table.

## To play from the desired chapter or track

### <Direct search>

Press the digit button of the chapter/track number to be played first.  
(Example) To play from chapter/track No. 3

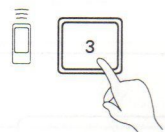

### To search for chapter or track number 10 or above:

Use button

(Example) To enter 17 : ,

To enter 30 : , , ,

### <Normal search>

Chapters can also be searched using CHP/TM.  
(Example) To search chapter No. 17



The button cannot be used in this case.

## Convenient function

When power is OFF (STANDBY), if you press the OPEN/CLOSE on the unit, power switches ON, and the disc table comes out (Auto Power function).

## \* Precautions concerning disc loading

- Do not place more than one disc on the disc table. If two discs are placed one on top of the other on the disc table, discs may be scratched and/or a malfunction may occur.
- Playback is not possible unless the disc is placed properly.

## To avoid malfunctions, be especially careful about the following points:

- Do not place any object other than a disc on the disc table.
- Do not move the player while a disc is playing. This will cause the disc to be scratched.
- Be careful not to catch your finger in the disc table section while the disc table is being retracted into the unit. Also, be careful that children do not put their hands inside the unit while the disc table is open. This may cause injury.

**DISC SIDE (A) (B)**

**To specify side A or B for play:**

Side A refers to the upper side of a disc loaded in the table, and B side refers to the reverse side. This is different from the actual A and B sides of the disc.

To play side A only, press the DISC SIDE A without pressing ►/II. After side A has finished, the player stops. To play side B only, press the DISC SIDE B without pressing ►/II. After side B has finished, the player stops.

**Indications when disc sides change**

● **When changing from side A to side B**



● **When changing from side B to side A**



**DIRECT CD**

Since the picture circuit is deactivated and the interference between signals is eliminated with the Direct CD function, more pure sound can be reproduced.

- When the Direct CD function is activated, the player does not display information on the monitor screen.
- In Direct CD mode, time for starting play becomes short compared with that of normal play operation.

After performing step 1 on the previous page, press the DIRECT CD.

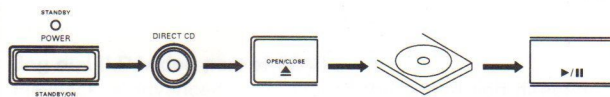

**To exit Direct CD mode:**

Press DIRECT CD again.

**To play an LD:**

Cancel the Direct CD mode. Otherwise, the LD cannot be set on the disc table.

**NOTE:**

During LD play, the player does not enter Direct CD mode even if DIRECT CD is pressed.

During CDV play, the player automatically turns on and off the picture circuit according to the video part or audio part in the Direct CD mode.

**On screen display:**

The information is displayed on the screen by pressing DISPLAY on the remote control unit. Also, when programming or editing, the information is displayed.

By turning off the screen display or canceling the input mode, the player automatically turns off the picture circuit, and the screen turns to black.

**Switching audio**

Each time AUDIO D/A is pressed during playback, audio output is switched.

For example:

- to hear only the analog audio of a disc with digital audio
- to hear only one channel of stereo disc
- to select audio of the multiplex disc

**LD**

**LD with digital audio**

Audio source can be switched between digital audio, analog audio, L channel and R channel of stereo audio.

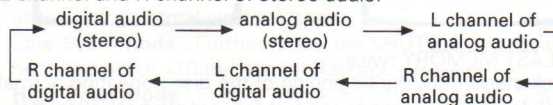

- With a disc encoded with CX auto-switching signals
  - CX off (stereo) → CX on (stereo) → CX on (L channel)
  - ← CX off (R channel) ← CX off (L channel) ← CX on (R channel)

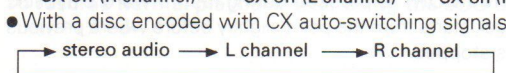

**LD/CD/CDV**

**LD with analog audio CD or CDV**



With a Multi Audio disc (an LD bearing the **digital** mark and the MULTI AUDIO mark or the **digital SOUND/MULTI AUDIO** mark), you can listen to the various audio tracks recorded on the disc by using AUDIO to select between the analog and digital tracks, and to select between the left (1/L) and right (2/R) channels.

**NOTE:**

With AC-3 discs, sound is not heard when the analog R channel is selected.

**Discs marked with the CX mark**

Discs marked CX are recorded with the CX noise reduction system for powerful audio reproduction with little noise. (Analog audio only) However, some discs marked CX are not encoded with the signals necessary to instruct the unit automatically switch on the CX system. If sound is noisy or undulates when a disc with a CX mark is played, press AUDIO D/A on the remote control unit.

- CX is a trademark of CBS Inc. This player meets the CX EXPANDING SPECIFICATION.

**Chapter (Track) Skip - To search for the beginning of a chapter/track**

**LD/CD/CDV**

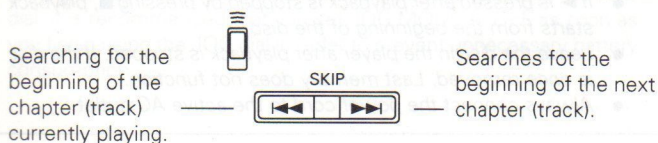

Press a button repeatedly or hold it depressed (only with the remote control unit); the chapters (tracks) will be skipped successively.

- When I◀◀ or ▶▶I is pressed in stop mode, playback starts.

## TO PLAY AN LD, CDV OR CD

LD

### Still frame and Frame-by-Frame advance function

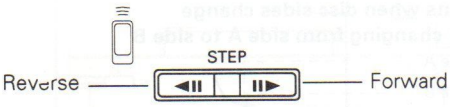

Press repeatedly for frame-by-frame advance.

### MULTI-SPEED To vary the playback direction or speed

LD

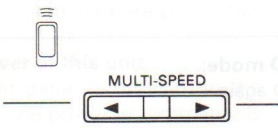

Press for reverse playback. Press for forward playback.

speed display	Playback speed
1/8	1/8 of the normal playback
1/2	half the normal playback
x2	twice the normal playback
1/2	half the normal playback
1/8	1/8 of the normal playback
1/30	1/30 of the normal playback

When MULTI-SPEED is pressed once, playback speed becomes 1/8 of the normal playback. Each time the same button is pressed, playback speed changes as shown in the table.

**During Multi-speed playback:**  
Sound is not output.

### Automatic picture stop

Some of discs contain a recording of a special code called the "picture stop code", which turns normal play or slow play automatically into still frame display.

To cancel the automatic picture stop operation, press and hold ►/II for more than 2 seconds until "PSC ON" (picture stop cancel ON) is displayed on the screen. To re-activate, press and hold ►/II for more than 2 seconds again until "PSC OFF" is displayed.

### Last memory (LD)

When playback of an LD is stopped, it can be resumed from where it was interrupted.

In standby mode, by pressing LAST MEMORY the power is automatically turned on and playback of the loaded disc is resumed.

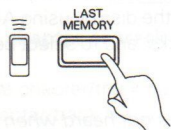

After playback of an LD is stopped by pressing ■, leave the disc in the player. Press LAST MEMORY.

**To resume playback from where playback is stopped:**



position slightly before the playback is stopped.

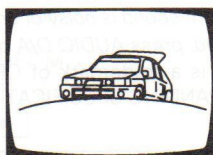

position where playback is stopped.

Press LAST MEMORY once. Playback starts from the point slightly before where ■ is pressed.

**Playback of the last played part, repeating normal playback for about 2 seconds and fast-forward playback alternately, then normal playback from the point slightly before where playback is stopped.**

Repetition of normal playback for about 2 seconds and fast-forward playback.

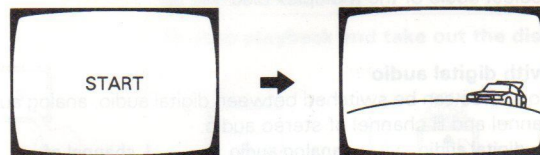

Press LAST MEMORY twice.

Playback starts from the beginning of the disc, repeating normal playback for about 2 seconds and fast-forward playback alternately. Then player enters normal playback mode from the point slightly before where ■ is pressed.

When LAST MEMORY is pressed during fast-forward playback, normal playback starts from the point slightly before where previous playback was stopped.

### NOTES:

- Last memory function is carried out only for playback of an LD. With CD or CDV, Last memory does not function.
- If ► is pressed after playback is stopped by pressing ■, playback starts from the beginning of the disc.
- Leave the disc in the player after playback is stopped. If the disc is once removed, Last memory does not function.
- Always connect the power cord to the active AC outlet.



**Search using the SHUTTLE ring and JOG dial/◀▶ Scan**

Using the Shuttle Ring and Jog Dial changes playback speed and direction. This function is useful to search for a desired passage.

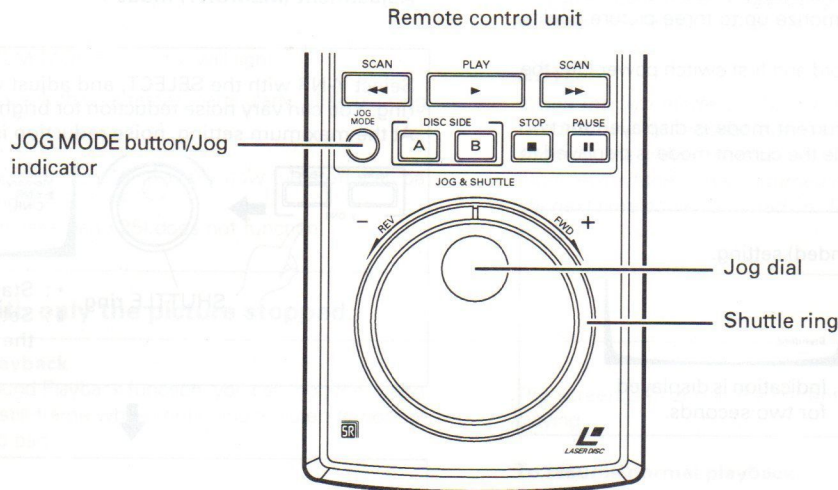

**Jog dial (LD/video part of CDV)**

Playback is advanced according to the speed and direction of rotation of the JOG dial. Both forward and reverse playback is possible, and frames can be advanced at speeds of 1/2 speed, normal speed, and double speed. Rotating the jog dial clockwise forwards playback. Conversely, rotating it counterclockwise left reverses playback. To use the JOG dial on the remote control unit, first press JOG MODE so that Jog indicator lights. During playback of an LD or CDV video part, when the JOG dial stops rotating, the frame is displayed.

**Shuttle ring**

While rotating the SHUTTLE ring, playback advances or reverses at high speed. There are four scan modes which can be selected with rotational angles of the SHUTTLE ring.

**x2 speed** : Slightly rotate the SHUTTLE ring. Scan speed becomes about x2 the normal playback speed.

**x5 speed** : Further rotate the SHUTTLE ring. Scan speed becomes about x5 the normal playback speed.

**Low Scan mode** : Further rotate the SHUTTLE ring. Scan speed becomes about x10 the normal playback speed.

**High Scan mode** : Further rotate the SHUTTLE ring. Scan speed becomes about x20 the normal playback speed.

The SCAN can also be used to enter scan mode.

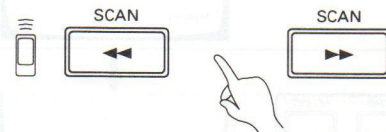

When the button is pressed, scan speed is x10 the normal playback speed for about two seconds and then becomes x20 the normal playback speed.

To switch the screen display, press the DISPLAY button.

- With video part of CDV, High Scan mode cannot be carried out.
- CDs or audio part of CDVs : Sound is heard at low volume level while scanning.
- Others: Sound is muted.

**To resume normal playback after using the JOG dial:**

Press PLAY ▶.

**When not using the JOG dial on the remote control unit, set JOG MODE to OFF.**

Although JOG MODE will automatically switch OFF (The Jog indicator goes out) approximately 5 minutes after you stop operating the JOG dial, it is recommended that you set JOG MODE to OFF as soon as you finish using the JOG dial in order to prevent unnecessary battery consumption.

**Notes on CAV:**

While scanning, noise may occur on the screen. This is not a malfunction.

**Notes on CLV:**

- While scanning, the color of the image may fade out or the image sometimes fluctuates.
- The scan speed is different between inner tracks and outer tracks.

## PICTURE QUALITY ADJUSTMENT (V-DNR)

When playing some LDs, there may be noise or color distortion. Digital NR reduces this noise and color distortion. You can independently adjust luminance (brightness) and saturation (color) as desired.

### Selecting picture quality

- Select with the remote control's memory button. This unit has three memories. You can memorize up to three picture quality settings.
- When you plug in the power cord and first switch power ON, the setting is STANDARD.
- Press MEMO once, and the current mode is displayed for two seconds. Press the button while the current mode is displayed to switch to the next mode.

#### STANDARD:

This is the standard (recommended) setting.

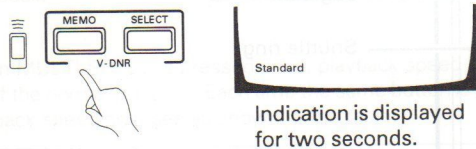

#### MEMORY:

These are your settings. Confirm setting adjustments by pressing the SELECT. This puts you in the Picture Quality Adjustment mode.

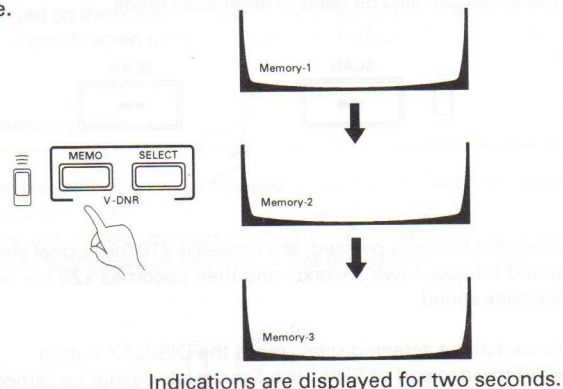

- When you plug in the power cord and first switch power ON, the settings in MEMO are STANDARD.

#### NR OFF:

This is the NR OFF setting. Other settings are the same as STANDARD.

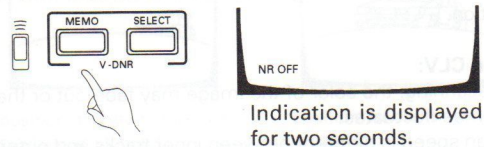

- When picture selection is STANDARD with NR OFF, you can confirm settings by pressing the SELECT. (Adjustment is not possible.)

### Perform picture quality settings in the Picture Quality Adjustment (MEMORY) mode

Select Y-NR with the SELECT, and adjust with the SHUTTLE ring. You can vary noise reduction for brightness (in 10 steps). At the maximum setting, noise reduction is maximum.

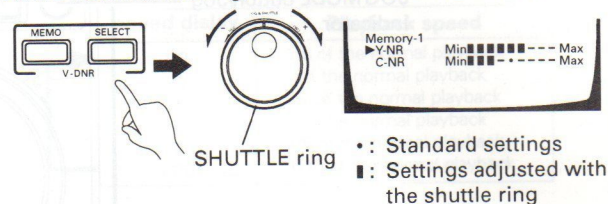

Select C-NR with the SELECT, and adjust with the SHUTTLE ring. You can vary noise reduction for color (in 10 steps). At the maximum setting, noise reduction is maximum.

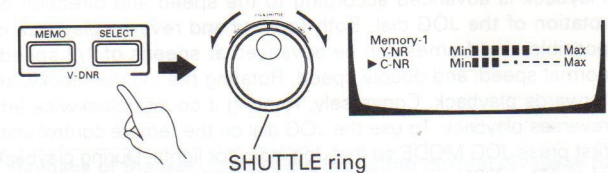

- If you do not operate the memory button or shuttle ring for 15 seconds, setting displays go off, but setting data is stored in memory.

#### Note:

- During play of a CDV's audio part, the selected picture quality settings for the video part are stored in memory.
- Picture quality settings are stored in memory until the power cord is disconnected from the wall socket.
- You can adjust V-DNR settings even when not playing a disc, but you won't notice the effect of these adjustments until images are displayed on screen.
- Depending on the disc and the scene, it may be difficult to see the noise reduction effect.
- With pictures of still images, Y-NR and C-NR are OFF, regardless of settings, and Y/C is set to minimum. Which means that adjustments for still images will change setting values (displayed values) but not picture quality. (CAV disc Y-NR, C-NR, Sharp are also effective for still images.)
- When you set V-DNR to STANDARD OFF, adjustments are not possible, but pressing the Select button displays settings for two seconds.
- When a CLV (extended play) disc is displaying a still image, Y-NR and C-NR are off, and adjustment to the setting values is not effective. Adjustment will change the displayed value on the indicator but will not change the picture quality. Therefore, do not display a still image when adjusting the setting values.

## WATCHING A MOVIE DISC - FILM MODE

Press **FILM MODE** on the front panel.



The **FILM MODE** indicator will light.

Set to ON in accordance with your tastes, particularly when viewing movie discs.

When the film mode is ON:

- The display in the front panel display window turns off (can be turned on/off using the FL OFF).
- The screen display (see page 25) does not function.

- The screen is blanked (blanked) while changing disc sides.
- The TOC is not read, in order to shorten the side-changing time as much as possible. As a result, random playback cannot be performed, even when the discs contain TOC codes. In addition, the remaining time ABS time and total time displays will not function. (These displays will function normally if the disc is played back once before using the film mode.)
- Press the Film Mode button once more to switch OFF.

**NOTE:**

*When the film mode is ON, the display in the front panel display window will not appear even when the power is turned on. In addition, the player memorizes the ON/OFF condition of the film mode even if the power is turned off, so the display will remain off the next time power is turned on. To turn the display on again, press FL OFF.*

## Ordinary play with only the picture stopped.

### Still with Sound Playback

With the Still with Sound Playback function, you can stop the video image and display a still frame while continuing to listen to normal playback of the audio part.

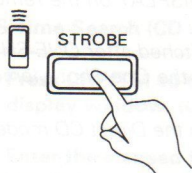

During normal playback, press **STROBE** when the desired scene appears on the screen.

The screen is frozen at the current frame and the audio continues playing.

**To resume normal playback:**

Press **PLAY** ▶

### Strobe Motion Playback

With the Strobe Motion Playback function, the still frame displayed using the Still with Sound Playback function is replaced with successive still frames at regular intervals (variable), resulting in a strobe motion effect.

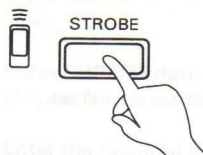

After pressing **STROBE**.

The still frames shown on the screen are replaced in sequence according to the selected replacement interval, while the audio continues as normal.

By repeated pressing of **STROBE**, one of four different replacement intervals can be selected.

STROBE button	Screen display	Replacement interval
	STROBE	Still
	1/90	Every 3 seconds
	1/30	Every second
	1/8	Every 8 frame
	1/30	Every second
	1/90	Every 3 seconds

Normal playback is carried out at 30 frames/second. In order to maintain normal audio playback, faster than normal playback modes such as x2 are not provided.

**To resume normal playback:**

Press **PLAY** ▶

## One-Shot Memory

The One-Shot Memory function stores the image of a single frame in the player's memory. When the One-Shot Memory function is activated and playback of the current disc is completed, the stored image is recalled and displayed on the screen. Since the image is displayed even after playback is completed, this function is convenient for displaying an image on the screen while changing discs. This function also allows you to change discs and listen to the audio of a CD or CDV disc while the image remains on the screen as a background video image.



During normal playback, press ONE-SHOT MEMORY when the desired scene appears on the screen.

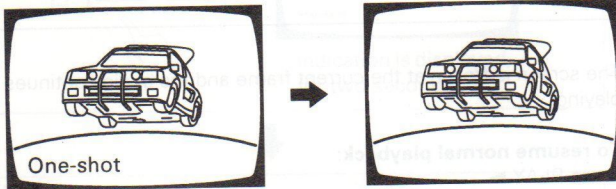

The frame displayed when the button was pressed is stored in memory. "One-Shot" is displayed on the TV screen for a few seconds.

After playback is finished, the memorized frame appears on the screen. In this state, even if you change discs the scene displayed on the TV screen does not change. To cancel the One-Shot Memory function in order to play the video from another disc, press ONE-SHOT MEMORY again.

### With CDV discs, the following operation can also be performed:

1. Press ONE-SHOT MEMORY during playback of the video part.
  2. Perform a direct search to the audio part.
- The memorized image of the video part is displayed on the screen while the audio part is played back.

### NOTES:

- With the One-Shot Memory function, since the player memorizes the selected frame by recording its address, a frame which is slightly different than the one you thought you selected may be displayed. Also, if seconds are not recorded on the disc, a completely different frame may be displayed.
- While the memorized image is displayed on the TV screen, the character display will not appear on the screen. The display on the player can be switched by using DISPLAY on the remote control unit.
- With two-sided LDs, if disc side is switched after ONE-SHOT MEMORY is pressed during playback, the One-Shot Memory function will be canceled.
- One-Shot Memory does not function in the Direct CD mode.

## TO SEARCH FOR A PARTICULAR TIME/FRAME -

### Time Number Search/Track Time Search/ABS Time Search/Frame Number Search

**Time Number Search - Example : To search for the scene located at time number 12 min. 34 sec (CLV)**

**1. Press CHP/TM during playback.**

When the display shows chapter No., press this button.

**2. Enter 1, 2, 3 and 4 with the digit buttons.**

If you make a mistake during entry:

Press CLEAR to reset the time number to "0.00", and then press the correct digit buttons.

**3. Press PLAY ►.**

**CAUTION**

If a disc does not contain information on the digits of seconds, specify the time number only as far as the minute digits.

**Track Time Search - To search for a time on a specified track (CD/CDV)**

**1. Press CHP/TM.**

**2. Press SKIP ◀◀ or ▶▶ so that the desired track number appears in the front panel display window.**

**3. Enter the track time (elapsed time from the beginning of the specified track) with the digit buttons (0 - 9).**

**4. Press PLAY ►.**

**ABS Time Search (CD only) - To search for a point by designating the elapsed time from the beginning of the disc**

**1. Press CHP/TM so that "Ab" appears in the front panel display window. (On the monitor screen, "ABS" appears.)**

**2. Enter the elapsed time from the beginning of the disc with the digit buttons (0 - 9).**

**3. Press PLAY ►.**

Playback starts from the specified elapsed time.

**Frame Number Search (CAV disc only) - To search by designating the frame number**

Any desired frame can be searched for by specifying its frame number.

**1. Press CHP/TM during playback. When the display shows chapter No., press this button again. "Frame 0" is displayed.**

**2. Enter the required frame number with the digit buttons (0 - 9).**

**3. Press PLAY ►.**

**NOTES:**

- The +10 button does not function.
- If you make a mistake during entry, press CLEAR and press the correct digit buttons.

**To exit search mode:**

Press CLEAR.

**When PLAY ► on the remote control unit is pressed:**

A still frame is displayed (LD or video part of CDV). To start normal playback, press PLAY ►.

## TO PLAY ALL CHAPTERS/TRACKS IN RANDOM ORDER - Random Playback

Random Playback allows all chapters/tracks to be played in random order.

- If RANDOM is pressed during Random playback, the current playing order is canceled and random playback starts in another order.
- In LD which contains TOC, first press ► and then press RANDOM.

Press **RANDOM** on the remote control unit.

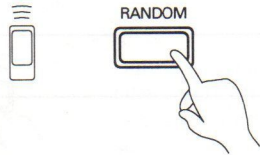

**To stop Random Playback:**

Press ■

**During Random Playback:**

- When the ►► is pressed, the playback order of chapters/tracks is changed.
- When the ◀◀ is pressed, the playback returns to the beginning of the chapter or track being played.
- Random playback is canceled by pressing CLEAR. Playback continues in normal playback mode.

### NOTES:

- With Random Playback, chapter No. 0 will not be played.
- It is not possible to play back the programmed contents in random order.

LD/CDV/CD

## TO SEARCH FOR A PARTICULAR CHAPTER/TRACK - Hi-Lite Scan/Intro Scan

Press HILITE/INTRO.



**Hi-Lite scan (CD or audio part of CDV)**

Press in stop mode to play an 8-second period from 1 minute 00 seconds to 1 minute 8 seconds of every track in sequence. The "Hilite" is displayed during this operation. When the desired track is played, press ►. The unit enters play mode.

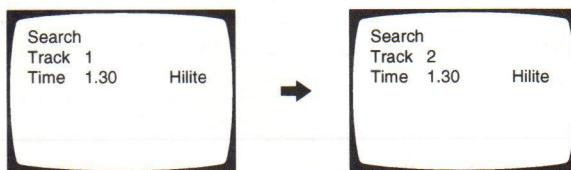

### NOTE:

If the button is pressed in play mode, the 8-second Hi-Lite scan starts from that moment. For example, if the button is pressed at 1 minute 30 seconds of track No. 2, 8 seconds from 1 minute 30 seconds to 1 minute 38 seconds of every remaining track will be played.

**Intro Scan (LD or video part of CDV)**

When HILITE/INTRO is pressed, the beginning of each chapter is played for about 8 seconds. The "Intro" is displayed in the Intro Scan mode.

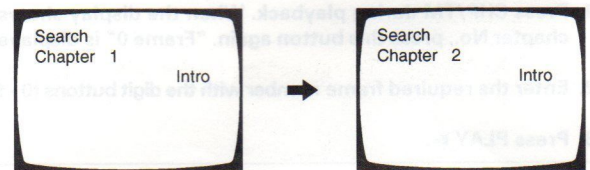

When the desired chapter or track is played, press ►. The unit enters play mode.

- With CDV, Intro Scan starts with the video part, and then the audio part will be played with Hi-Lite Scan.

### NOTE:

With discs which do not contain chapter numbers, Intro scan cannot be operated.

## TO REPEATEDLY PLAY A DESIRED PASSAGE - Repeat Playback

### Memory Repeat - To specify a point to return to later

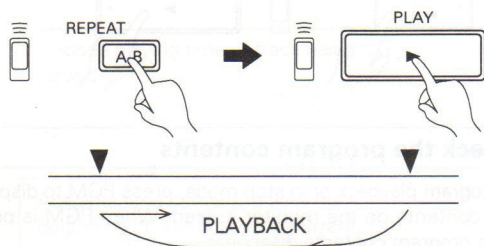

Press REPEAT A-B at the point you want to see or listen to again (point A). When you wish to return to point A, press ► on the remote control unit.

### A-B Repeat - To repeat a specified section

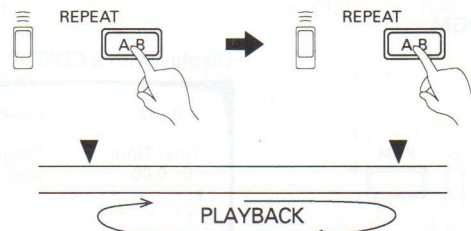

Press REPEAT A-B at the start point of the section to be repeated. Press REPEAT A-B at the end point of the section to be repeated. Playback returns to the beginning of the section and the section is repeated continuously.

### Chapter/Track Repeat - To repeat the current chapter or track

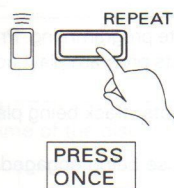

Press REPEAT while the chapter/track to be repeated is playing. When the end of the chapter/track is reached, the player returns to the beginning of the chapter/track and the chapter/track is played back repeatedly.

### Program Repeat - To repeat a program

With the program repeat function, you can repeatedly play programmed chapters or tracks in their programmed order.

Press REPEAT on the remote control unit while the program is being played.

- See page 24 for details on programming.

### Random Repeat - To repeat a random play

Press REPEAT during random playback.

With the random repeat function, you can repeatedly play the chapters or tracks in random order.

- See page 22 for details on Random playback.

### One Side Repeat - To repeat an entire side of a disc

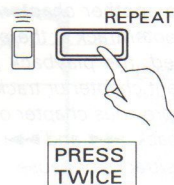

Press REPEAT twice. When playback reaches the end of the playback side, the player returns to the beginning of the disc and the same side is played back repeatedly.

### Two-Side Repeat - To repeat both sides of a disc (for two-sided LDs only)

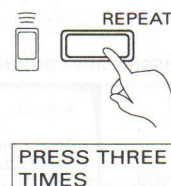

Press REPEAT three times. When playback of side A finishes, side B is played back, and when playback of side B finishes, side A is played back again.

#### To exit repeat mode:

Press CLEAR.

#### To specify a different point in Memory Repeat mode:

Press CLEAR to cancel the previously memorized point, and repeat the same operation as shown above. The previously memorized point is erased and replaced with the new point.

#### Memory Repeat and A-B Repeat with CDV discs:

These repeat functions can only be carried out within the video part or within the audio part, and cannot be carried out between the two parts.

#### With LDs which have no chapter numbers:

Chapter repeat cannot be carried out.

## TO PLAY ONLY DESIRED SCENES/TRACKS - Program Playback

Selected chapters (LD) or tracks (CDV/CD) can be played in any desired order (max. 24 chapters or tracks).

### 1. Press PGM.

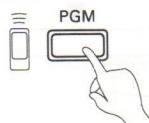

Display with a CD/CDV

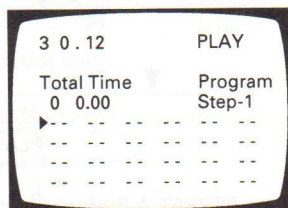

### 2. Select the desired chapters or tracks.

With two-sided, LDs, first specify side A or side B with DISC SIDE A or B and then enter the number of the desired chapter with the digit buttons.

**Example:** To program chapter 9 on side B, chapter 7 on side A, and chapter 18 on side B, in that order:

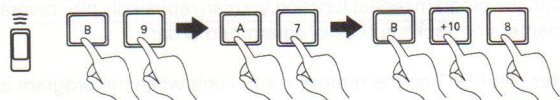

Screen display after programming is completed

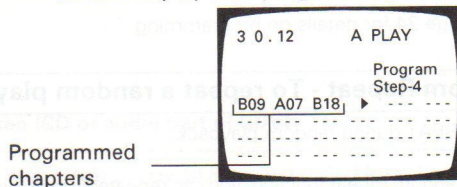

With single-sided LDs, CDs, and CDV discs, just enter the number of the desired chapter or track with the digit buttons.

**Example:** To program CD tracks 9, 7, and 18 in that order:

If you make a mistake during entry:

Press CLEAR and enter the correct number with the digit buttons.

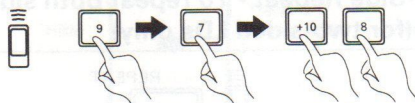

Screen display after programming is completed

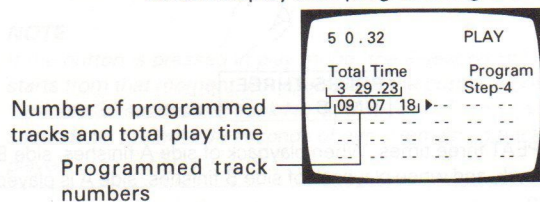

A pause between tracks/chapters can also be programmed by pressing **II** instead of the digit buttons.

If you make a mistake during entry:

Press CLEAR on the remote control unit and enter the correct number with the digit buttons.

### 3. Press ▶.



#### To check the program contents

During program playback or in stop mode, press PGM to display the program contents on the monitor screen. When PGM is pressed again, the program contents disappear.

- You can view the state of programming on the monitor screen.

#### To modify the program contents

To delete or change a programmed chapter/track or pause:

- Press PGM.
- Press **◀◀** or **▶▶** to place the cursor (▶) on the left side of the chapter/track or pause to be changed.
- To delete it, press CLEAR. To replace it with another chapter/track, enter the new chapter/track number with the digit buttons. Press **II** to enter a pause.
- Press PGM to complete programming. Pressing **▶** also completes programming and starts program playback with the new program contents.
  - Programmed chapter/track being played cannot be erased or changed.
  - Programmed pause being engaged cannot be erased or changed.

#### To clear the program playback

Press CLEAR to return to normal playback.

#### To clear the program contents:

- Open the disc table.
- Press CLEAR while in stop mode.

#### NOTES:

- If **▶▶** is held depressed during Program Playback, the playback position will move to another chapter/track, but when **▶▶** is released, the next chapter/track in the program will be played. If **◀◀** is held depressed, the playback position returns to the beginning of the current chapter or track being played, but it will not go beyond it to a previous chapter or track in the program.
- During program playback, **◀◀** and **▶▶** can be used to skip the programmed chapters/tracks or pause.



# DISPLAY SWITCHING

DISPLAY allows you to display informations including the play mode and disc playing time on the screen. Each press of DISPLAY switches the screen display as shown below.

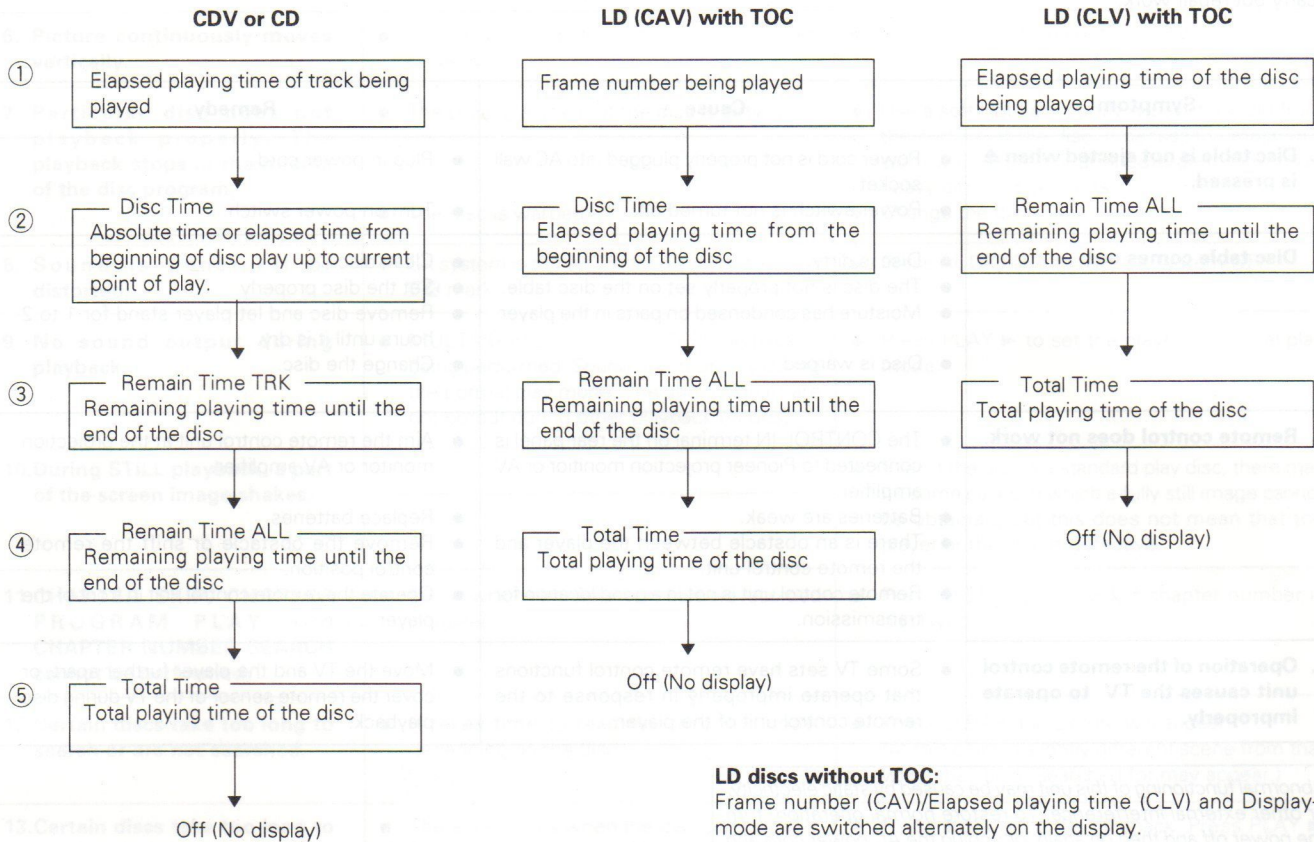

### LD discs without TOC:

Frame number (CAV)/Elapsed playing time (CLV) and Display-off mode are switched alternately on the display.

The actual screen display is as shown below.

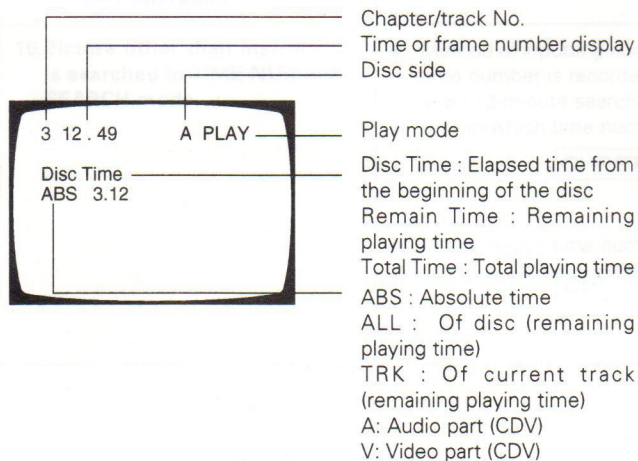

### Audio output level meter display:

During elapsed play time of the track mode of CD playback or CDV (audio part) playback, the audio output level meter will be displayed on the monitor screen.

### NOTE:

In some cases, the display output level may differ from the actual output level, but this is not a malfunction.

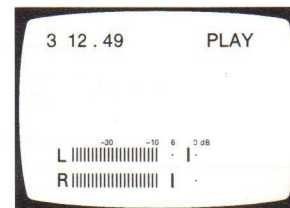

The screen display disappears automatically if you leave it for a long time (for about 80 minutes or more) without any operation. In this case, press any button on the remote control unit so that the screen display will appear on the screen.

# TROUBLESHOOTING

Incorrect operations are often mistaken for trouble and malfunctions. If you think that there is something wrong with this component, check the points below. Sometimes the trouble may lie in another component. Investigate the other components and electrical appliances being used. If the trouble cannot be rectified even after exercising the checks listed below, ask your nearest PIONEER authorized service center or your dealer to carry out repair work.

Symptom	Cause	Remedy
<b>1. Disc table is not ejected when ▲ is pressed.</b>	<ul style="list-style-type: none"> <li>● Power cord is not properly plugged into AC wall socket.</li> <li>● Power switch is not turned on.</li> </ul>	<ul style="list-style-type: none"> <li>● Plug in power cord.</li> <li>● Turn on power switch.</li> </ul>
<b>2. Disc table comes out.</b>	<ul style="list-style-type: none"> <li>● Disc is dirty.</li> <li>● The disc is not properly set on the disc table.</li> <li>● Moisture has condensed on parts in the player.</li> <li>● Disc is warped.</li> </ul>	<ul style="list-style-type: none"> <li>● Clean disc.</li> <li>● Set the disc properly.</li> <li>● Remove disc and let player stand for 1 to 2 hours until it is dry.</li> <li>● Change the disc.</li> </ul>
<b>3. Remote control does not work.</b>	<ul style="list-style-type: none"> <li>● The CONTROL IN terminal on the rear panel is connected to Pioneer projection monitor or AV amplifier.</li> <li>● Batteries are weak.</li> <li>● There is an obstacle between the player and the remote control unit.</li> <li>● Remote control unit is not in a good location for transmission.</li> </ul>	<ul style="list-style-type: none"> <li>● Aim the remote control unit at the projection monitor or AV amplifier.</li> <li>● Replace batteries.</li> <li>● Remove the obstacle or shift the remote control position.</li> <li>● Operate the remote control unit in front of the player.</li> </ul>
<b>4. Operation of the remote control unit causes the TV to operate improperly.</b>	<ul style="list-style-type: none"> <li>● Some TV sets have remote control functions that operate improperly in response to the remote control unit of the player.</li> </ul>	<ul style="list-style-type: none"> <li>● Move the TV and the player further apart, or cover the remote sensor of the TV during disc playback.</li> </ul>

*Abnormal functioning of this unit may be caused by static electricity, or other external interference. To restore normal operation, turn the power off and then on again, or unplug the AC power cord and then plug it in again.*

WHEN A LASERVISION DISC IS BEING PLAYED

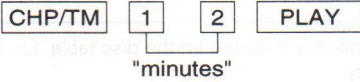
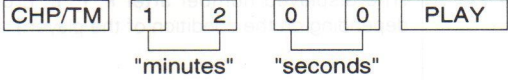
Symptom	Cause	Remedy
5. Disc is rotating but there is no picture.	<ul style="list-style-type: none"> <li>The TV set is not turned on.</li> <li>Wrong connections from player to TV.</li> </ul>	<ul style="list-style-type: none"> <li>Turn on TV.</li> <li>Make correct connections.</li> </ul>
6. Picture continuously moves vertically.	<ul style="list-style-type: none"> <li>The TV vertical-hold control is not adjusted properly.</li> </ul>	<ul style="list-style-type: none"> <li>Adjust vertical-hold control on TV.</li> </ul>
7. Particular disc does not playback properly. The playback stops in the middle of the disc program.	<ul style="list-style-type: none"> <li>The playing surface of the disc is dirty.</li> <li>The disc is warped.</li> </ul>	<ul style="list-style-type: none"> <li>Use a soft cloth and lightly wipe off the dirt from the surface of the disc. If necessary, moisten a cloth with diluted neutral detergent to remove heavy dirt or fingerprints.</li> <li>Change the disc.</li> </ul>
8. Sound is unnatural or distorted.	<ul style="list-style-type: none"> <li>CX system is turned ON for disc which has no  mark.</li> </ul>	<ul style="list-style-type: none"> <li>Press AUDIO D/A to turn CX system OFF.</li> </ul>
9. No sound output during playback.	<ul style="list-style-type: none"> <li>MULTI-SPEED or STILL/STEP playback is being performed. Sound is output only during the normal play mode. The audio signals are not output during other playback modes.</li> </ul>	<ul style="list-style-type: none"> <li>Press PLAY ► to set the player to normal play mode.</li> </ul>
10. During STILL playback, a part of the screen image shakes.		<ul style="list-style-type: none"> <li>Even if the disc is a standard play disc, there may be some cases in which a fully still image cannot be obtained, but this does not mean that the player or the disc is defective.</li> </ul>
11. CHAPTER SKIP, CHAPTER PROGRAM PLAY and CHAPTER NUMBER SEARCH cannot be performed.	<ul style="list-style-type: none"> <li>Disc in which no chapter numbers are recorded is loaded.</li> </ul>	<ul style="list-style-type: none"> <li>Press DISPLAY to check if chapter number is displayed.</li> </ul>
12. Certain discs take too long to search or are not searched.	<ul style="list-style-type: none"> <li>It takes time to read the recorded code, depending on the disc.</li> </ul>	<ul style="list-style-type: none"> <li>Press CLEAR and picture will appear. (At this point, a slightly different scene from that which has been searched for may appear.)</li> </ul>
13. Certain discs take too long to start or do not start.	<ul style="list-style-type: none"> <li>There are errors when the disc code is read. (There is no damage to the unit.)</li> </ul>	<ul style="list-style-type: none"> <li>Press ■ and stop the playback. Press PLAY ► and start the playback again. (Repeat this operation a few times.)</li> </ul>
14. The player takes too long to find point A-B (INTERVAL) REPEAT operation.	<ul style="list-style-type: none"> <li>Same as item 12 above.</li> </ul>	<ul style="list-style-type: none"> <li>Same as item 12 above. (The repeat mode is canceled.)</li> </ul>
15. Picture other than instructed is searched in TIME NUMBER SEARCH mode.	<ul style="list-style-type: none"> <li>Method of inputting numerals in the TIME NUMBER SEARCH mode differs, depending on whether time number is recorded on disc in hours and minutes or minutes and seconds as shown below: [e.g.] 12-minute search</li> <li>Disc in which time number is recorded in minutes.</li> </ul> <div style="text-align: center;">  </div> <ul style="list-style-type: none"> <li>Disc in which time number is recorded in minutes and seconds.</li> </ul> <div style="text-align: center;">  </div>	

## TROUBLESHOOTING

### WHEN PLAYING BACK A COMPACT DISC

Symptom	Cause	Remedy
<b>16. Player stops immediately after playback started.</b>	<ul style="list-style-type: none"> <li>● Disc is loaded upside down (CD, CDV, one-sided LD discs).</li> <li>● The playing surface of the disc is dirty.</li> <li>● Disc is not properly set on the disc table.</li> </ul>	<ul style="list-style-type: none"> <li>● Load the disc correctly with the label side upward.</li> <li>● Use a soft cloth and lightly wipe off the dirt from the surface of the disc. If necessary, moisten a cloth with diluted neutral detergent to remove heavy dirt or fingerprints.</li> <li>● Set the disc properly.</li> </ul>
<b>17. No sound output.</b>	<ul style="list-style-type: none"> <li>● The stereo amplifier is not correctly connected.</li> <li>● You are not operating the stereo amplifier correctly.</li> <li>● The connection terminals and/or the plugs of the connection cords are dirty.</li> <li>● The plugs of the connection cords are disconnected, or are not fully pushed in.</li> <li>● The player is in pause mode.</li> </ul>	<ul style="list-style-type: none"> <li>● Connect the amplifier correctly.</li> <li>● Refer to the operating instructions for the amplifier, and operate the amplifier correctly.</li> <li>● Clean the plugs and terminals and connect again.</li> <li>● Make sure that connections are made correctly.</li> <li>● Press PLAY ► and restore the player to play mode.</li> </ul>
<b>18. Sound is distorted.</b>	<ul style="list-style-type: none"> <li>● The audio output jacks are connected to the PHONO jacks.</li> <li>● The connection terminals and/or the plugs of the connection cords are dirty.</li> <li>● The plugs of the connection cords are not fully pushed in.</li> </ul>	<ul style="list-style-type: none"> <li>● Connect to the AUX, CD, VDP, LD, or VCR jacks.</li> <li>● Clean the plugs and terminals and connect again.</li> <li>● Push the plug in firmly.</li> </ul>

#### When troubles occur:

When some troubles occur during use of the player, the following display (service number) appears on the display of the player and the TV screen. If you are in those trouble, follow the "Remedy" below.

#### Display window of the player

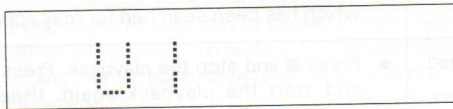

#### TV screen

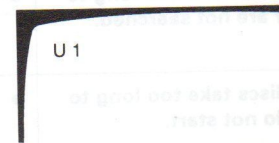

Displayed number	Condition of the player	Remedy
<b>U 1</b>	A disc is not loaded correctly on the disc table. Or, a disc is dirty.	Reload a disc corresponding to a disc guide on the disc table. Wipe the disc with a soft cloth.
<b>U 2</b>		Open the disc table and press ► again.
<b>F 5</b>	Two discs are loaded on the disc table. Or, a disc is dirty.	Load only one disc on the disc table. Wipe the disc with a soft cloth.
<b>P 2</b> <b>L 3</b> <b>E 4</b>	(The displayed number after P, F, L, E differs depending on the condition of the player.)	Open the disc table and press ► again. If the same service number is displayed, the player is in abnormal condition. When requesting service, please notify the displayed number on the display of the player or on the TV screen (for example, 'service number E 4').
<b>H 0</b> <b>H 1</b> <b>A 5</b>	The player is in abnormal condition. (The displayed number after A differs depending on the condition of the player.)	When requesting service, please notify the displayed number on the display of the player or on the TV screen (for example, 'service number H 1').

# SPECIFICATIONS

## 1. General

System ..... LaserVision Disc system and Compact Disc digital audio system  
 Laser ..... Semiconductor laser wavelength 780 nm  
 Power requirements ..... AC 120 V, 60Hz  
 Power consumption ..... 46 W  
 Weight ..... 8.7 kg (19lb 3oz)  
 Dimensions ..... 420 (W) x 432 (D) x 140 (H) mm  
 16-9/16 (W) x 17 (D) x 5-8/16 (H) in.  
 Operating temperature ..... +5° C ~ +35° C  
 (41°F ~ 95°F)  
 Operating humidity ..... 5 % ~ 85 %  
 (There should be no condensation of moisture.)

## 2. Disc

### LaserVision Discs

\*Maximum playing times  
 30 cm standard play disc ..... 1 hour/both sides  
 30 cm extended play disc ..... 2 hours/both sides  
 20 cm standard play disc ..... 28 min/both sides  
 14 min/one side  
 20 cm extended play disc ..... 40 min/both sides  
 20 min/one side  
 Spindle motor speed  
 Standard play disc ..... 1,800 rpm  
 Extended play disc ..... 1,800 rpm (inner circumference)  
 to 600 rpm (outer circumference)  
 (For a 30 cm disc)

### Compact Discs

DISC ..... Diameter: 5-inch, 3-inch, Thickness: 1.2 mm  
 Rotation direction (pickup side) ..... Counterclockwise  
 Linear speed ..... 1.2 ~ 1.4 m/sec  
 \*Maximum playing time ..... 74 min. 12 cm discs  
 20 min. 8 cm discs  
 (For stereo playback)

### Compact Discs with Video

DISC ..... Diameter: 12 cm, Thickness: 1.2 mm  
 Rotation direction (pickup side) ..... Counterclockwise  
 Linear speed ..... Audio portion : 1.2 ~ 1.4 m/sec  
 Video portion : 11 ~ 12 m/sec  
 \*Maximum playing time ..... Video portion : 5 min. (CLV)  
 Audio portion : 20 min. (Digital)

\*Actual playback time differs for each disc.

## 3. Video characteristics (two pairs)

Format ..... NTSC specifications  
 Video output  
 Level ..... 1 Vp-p nominal, sync. negative, terminated  
 Impedance ..... 75 Ω unbalanced  
 Jacks ..... Both RCA jacks

## 4. S-Video output (two pairs)

Y (luminance) - Output level ..... 1 Vp-p (75 Ω)  
 C (color) - Output level ..... 286 mVp-p (75 Ω)  
 Jack ..... S-VIDEO jack  
 Number of channels ..... 2

## 5. Audio characteristics (two pairs)

Output level  
 During analog audio output ..... 200 mVrms  
 (1 kHz, 40 %)  
 During digital audio output ..... 200 mVrms  
 (1 kHz, -20 dB)  
 Jacks ..... Both RCA jacks  
 Number of channels ..... 2

### Digital Audio Characteristics

Frequency response	4 Hz - 20 kHz
SN ratio	115 dB (EIAJ)
Dynamic range	98 dB (EIAJ)
Total harmonic distortion	0.0025 %
Wow and flutter	Limit of measurement (EIAJ)

## 6. Other Terminals

Control input/output ..... Both miniature jacks  
 Optical digital output ..... Optical digital jack  
 Coaxial digital output ..... RCA jack  
 AC-3 • RF output ..... RCA jack

## 7. Accessories

Remote control unit ..... 1  
 Size "AAA" (IEC R03) dry cell batteries ..... 2  
 Video cord ..... 1  
 S-VIDEO cable ..... 1  
 Audio cord ..... 1  
 Operating instructions ..... 1  
 Warranty card ..... 1

# SPECIFICATIONS

## 8. Remote control functions

	Function	Standard play Disc (CAV)	Extended play Disc (CLV)	Compact Disc with Video	Compact Disc
Basic Functions	Two-side play	YES	YES	NO	NO
	Single-side play	YES	YES	YES	YES
	Pause	YES	YES	YES	YES
	Stop	YES	YES	YES	YES
Search	Fast forward (forward and reverse)	YES	YES	YES	YES
	Chapter/Track skip	YES	YES	YES	YES
	Direct chapter/Track number search	YES	YES	YES	YES
	Frame number search	YES	NO	NO	NO
	Time number search	NO	YES	YES	YES
	Absolute time search	NO	NO	NO	YES
Program	Chapter/track program play	YES	YES	YES	YES
	Program correction	YES	YES	YES	YES
Repeat	Repeat between 2 points	YES	YES	YES	YES
	Memory repeat	YES	YES	YES	YES
	Chapter/Track repeat	YES	YES	YES	YES
	One-side repeat	YES	YES	YES	YES
	Two-side repeat	YES	YES	NO	NO
	Program repeat	YES	YES	YES	YES
	Random repeat	YES*1	YES*1	YES	YES
Trick play	Still/Step	YES	YES	YES*5	NO
	Multi-speed (Forward/reverse 4-level variable)	YES	YES	YES*5	NO
	Jog dial/Shuttle ring	YES	YES	YES	YES
Time display	Elapsed time display	NO	YES	YES	YES
	Absolute time display	YES*1	NO	NO	YES
	Remaining track time display	NO	NO	YES	YES
	Remaining total time display	YES*1	YES*1	YES	YES
	Total number of selections, total time display	YES*1	YES*1	YES	YES
Others	CX system ON/OFF	YES*2	YES*2	NO	NO
	Auto Digital/Analog switch	YES*3	YES*3	NO	NO
	One-shot memory	YES	YES	YES*5	NO
	Audio channel selection (Stereo, 1/L, 2/R)	YES	YES	YES	YES
	Hi-Lite scan	NO	NO	YES*4	YES
	Intro scan	YES	YES	YES*5	NO
	V-DNR	YES	YES	YES*5	NO
	Last Memory	YES	YES	NO	NO

\*1 Only disc with TOC

\*2 Valid for analog audio playing a disc with the  mark.

\*3 Can only be used with discs with digital audio tracks.

\*4 Audio part only

\*5 Video part only

**NOTE:**

Specifications and design are subject to possible modifications without notice, due to improvements.

SPECIFICATIONS

2. Remote control functions

		Model No. PD-M1	Model No. PD-M2	Model No. PD-M3	Model No. PD-M4
Basic Functions	Stop and start	YES	YES	YES	NO
	Play/Pause	YES	YES	YES	YES
	Fast Forward	YES	YES	YES	YES
	Stop	YES	YES	YES	YES
Search	10 seconds to represent and to search	YES	YES	YES	YES
	Character/stop sign	YES	YES	YES	YES
	Display character on the screen	YES	YES	YES	YES
	Frame advance search	YES	YES	YES	NO
	Time number search	YES	YES	YES	YES
	Advanced search	YES	YES	YES	YES
Repeat	Repeat for a program only	YES	YES	YES	YES
	Repeat for a disc only	YES	YES	YES	YES
Repeat	Repeat playback 2 program	YES	YES	YES	YES
	Repeat playback	YES	YES	YES	YES
	Repeat playback (manual)	YES	YES	YES	YES
	Overhaul repeat	YES	YES	YES	YES
	Repeat and search	YES	YES	YES	NO
	Repeat search	YES	YES	YES	YES
Time display	Time display	YES	YES	YES	YES
	Multi-speed time display (video & audio) (optional)	YES	YES	YES	YES
Time display	Elapsed time display	YES	YES	YES	YES
	Remaining track time display	YES	YES	YES	YES
	Remaining total time display	YES	YES	YES	YES
	Total number of selections, total time display	YES	YES	YES	YES
	Time display	YES	YES	YES	YES
Others	CL system (On/Off)	YES	YES	YES	NO
	Auto Object/Audio search	YES	YES	YES	YES
	Disc short memory	YES	YES	YES	YES
	Audio channel selection (video)	YES	YES	YES	YES
	Multi-speed	NO	YES	YES	YES
	Disc cover	YES	YES	YES	NO
Capacitance	YES	YES	YES	NO	

\*1 Only disc with TOC.  
 \*2 Aid for audio audio (video) search and LSC (Laser Search Control).  
 \*3 Can only be used with disc with digital audio tracks.  
 \*4 Audio part only.  
 \*5 Video part only.

NOTE  
 Specifications are subject to change without notice due to improvement.

**LaserDisc** is a trademark of Pioneer Electronic Corporation.

Published by Pioneer Electronic Corporation.  
 Copyright © 1995 Pioneer Electronic Corporation.  
 All rights reserved.

**PIONEER ELECTRONIC CORPORATION** 4-1, Meguro 1-Chome, Meguro-ku, Tokyo 153, Japan  
**PIONEER ELECTRONICS [USA] INC.** P.O. BOX 1540, Long Beach, California 90810-1540  
**PIONEER ELECTRONICS OF CANADA, INC.** 300 Allstate Parkway Markham, Ontario L3R 0P2, Canada  
**PIONEER ELECTRONIC [EUROPE] N.V.** Haven 1087 Keetberglaan 1, 9120 Melsele, Belgium, TEL:03/570.05.11  
**PIONEER ELECTRONICS AUSTRALIA PTY. LTD.** 178-184 Boundary Road, Braeside, Victoria 3195, Australia, TEL: [03] 580-9911  
**PIONEER ELECTRONICS DE MEXICO S.A. DE C.V.** Augusto Rodin NO.128 PB Col. San Juan Mixcoac Mexico D.F. CP.03730 TEL:52-5-598-3950