

Operating Instructions

CD CDV LD PLAYER

CLD-V510

LaserDisc.

NTSC

LaserKaraoke

COMPACT
disc
DIGITAL AUDIO

CD VIDEO

L
LASER DISC

- This player does not apply to business use, and CD-ROM/CD graphic discs cannot be played with this player.

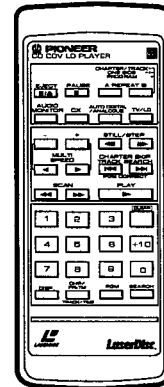
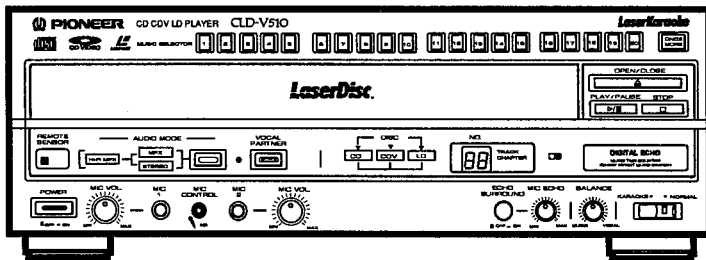

Thank you for buying this Pioneer product. Please read through these operating instructions so you will know how to operate your model properly. After you have finished reading the instructions, put them away in a safe place for future reference. In some countries or regions, the shape of the power plug and power outlet may sometimes differ from that shown in the explanatory drawings. However, the method of connecting and operating the unit is the same.

WARNING: TO PREVENT FIRE OR SHOCK HAZARD, DO NOT EXPOSE THIS APPLIANCE TO RAIN OR MOISTURE.

IMPORTANT NOTICE

[For U.S. and Canadian models]

The serial number for this equipment is located on the rear panel. Please write this serial number on your enclosed warranty card and keep it in a secure area. This is for your security.

[For Canadian model]

CAUTION: TO PREVENT ELECTRIC SHOCK DO NOT USE THIS (POLARIZED) PLUG WITH AN EXTENSION CORD, RECEPTACLE OR OTHER OUTLET UNLESS THE BLADES CAN BE FULLY INSERTED TO PREVENT BLADE EXPOSURE.

ATTENTION: POUR PREVENIR LES CHOCS ELECTRIQUES NE PAS UTILISER CETTE FICHE POLARISEE AVEC UN PROLONGATEUR, UNE PRISE DE COURANT OU UNE AUTRE SORTIE DE COURANT, SAUF SI LES LAMES PEUVENT ETRE INSEREES A FOND SANS EN LAISSER AUCUNE PARTIE A DECOUVERT.

IMPORTANT



The lightning flash with arrowhead, within an equilateral triangle, is intended to alert the user of the presence of uninsulated "dangerous voltage" within the product's enclosure that may be of sufficient magnitude to constitute a risk of electric shock to persons.



CAUTION:
TO PREVENT THE RISK OF ELECTRIC SHOCK, DO NOT REMOVE COVER (OR BACK). NO USER-SERVICEABLE PARTS INSIDE. REFER SERVICING TO QUALIFIED SERVICE PERSONNEL.



The exclamation point within an equilateral triangle is intended to alert the user of the presence of important operating and maintenance (servicing) instructions in the literature accompanying the appliance.

SAFETY INSTRUCTIONS

READ INSTRUCTIONS — All the safety and operating instructions should be read before the appliance is operated.

RETAIN INSTRUCTIONS — The safety and operating instructions should be retained for future reference.

HEED WARNINGS — All warnings on the appliance and in the operating instructions should be adhered to.

FOLLOW INSTRUCTIONS — All operating and use instructions should be followed.

CLEANING — Unplug this video product from the wall outlet before cleaning. Do not use liquid cleaners or aerosol cleaners. Use a damp cloth for cleaning.

ATTACHMENTS — Do not use attachments not recommended by the video product manufacturer as they may cause hazards.

WATER AND MOISTURE — Do not use this video product near water — for example, near a bathtub, wash bowl, kitchen sink, or laundry tub, in a wet basement, or near a swimming pool, and the like.

ACCESSORIES — Do not place this video product on an unstable cart, stand, tripod, bracket, or table. The video product may fall, causing serious injury to a child or adult, and serious damage to the appliance. Use only with a cart, stand, tripod, bracket, or table recommended by the manufacturer, or sold with the video product. Any mounting of the appliance should follow the manufacturer's instructions, and should use a mounting accessory recommended by the manufacturer.

CART — An appliance and cart combination should be moved with care. Quick stops, excessive force, and uneven surfaces may cause the appliance and cart combination to overturn.



VENTILATION — Slots and openings in the cabinet are provided for ventilation and to ensure reliable operation of the video product and to protect it from overheating, and these openings must not be blocked or covered. The openings should never be blocked by placing the video product on a bed, sofa, rug, or other similar surface. This video product should never be placed near or over a radiator or heat register. This video product should not be placed in a built-in installation such as a bookcase or rack unless proper ventilation is provided or the manufacturer's instructions have been adhered to.

POWER SOURCES — This video product should be operated only from the type of power source indicated on the marking label. If you are not sure of the type of power supply to your home, consult your appliance dealer or local power company. For video products intended to operate from battery power, or other sources, refer to the operating instructions.

POWER-CORD PROTECTION

Power-supply cords should be routed so that they are not likely to be walked on or pinched by items placed upon or against them, paying particular attention to cords at plugs, convenience receptacles, and the point where they exit from the appliance.

POLARIZATION — This video product is equipped with a polarized alternating current line plug (a plug having one blade wider than the other). This plug will fit into the power outlet only one way. This is a safety feature. If you are unable to insert the plug fully into the outlet, try reversing the plug. If the plug should still fail to fit, contact your electrician to replace your obsolete outlet. Do not defeat the safety purpose of the polarized plug.

LIGHTNING — For added protection for this video product receiver during a lightning storm, or when it is left unattended and unused for long periods of time, unplug it from the wall outlet and disconnect the antenna or cable system. This will prevent damage to the video product due to lightning and power-line surges.

POWER LINES — An outside antenna system should not be located in the vicinity of overhead power lines or other electric light or power circuits, or where it can fall into such power lines or circuits. When installing an outside antenna system, extreme care should be taken to keep from touching such power lines or circuits as contact with them might be fatal.

OVERLOADING — Do not overload wall outlets and extension cords as this can result in the risk of fire or electric shock.

OBJECT AND LIQUID ENTRY — Never push objects of any kind into this video product through openings as they may touch dangerous voltage points or short-out parts that could result in a fire or electric shock. Never spill liquid of any kind on the video product.

SERVICING — Do not attempt to service this video product yourself as opening or removing covers may expose you to dangerous voltage or other hazards. Refer all servicing to qualified service personnel.

DAMAGE REQUIRING SERVICE

Unplug this video product from the wall outlet and refer servicing to qualified service personnel under the following conditions:

- When the power-supply cord or plug is damaged.
- If liquid has been spilled, or objects have fallen into the video product.
- If the video product has been exposed to rain or water.
- If the video product does not operate normally by following the operating instructions. Adjust only those controls that are covered by the operating instructions as an improper adjustment of other controls may result in damage and will often require extensive work by a qualified technician to restore the video product to its normal operation.
- If the video product has been dropped or the cabinet has been damaged.
- When the video product exhibits a distinct change in performance — this indicates a need for service.

REPLACEMENT PARTS — When replacement parts are required, be sure the service technician has used replacement parts specified by the manufacturer or having the same characteristics as the original part. Unauthorized substitutions may result in fire, electric shock or other hazards.

SAFETY CHECK — Upon completion of any service or repairs to this video product, ask the service technician to perform safety checks to determine that the video product is in proper operating condition.

OUTDOOR ANTENNA GROUNDING — If an outside antenna is connected to the antenna terminal, be sure the antenna system is grounded so as to provide some protection against voltage surges and built-up static charges.

In the U.S.A. section 810 of the National Electrical Code, ANSI/NFPA No. 70-1984, provides information with respect to proper grounding of the mast and supporting structure, grounding of the lead-in wire to an antenna discharge unit, size of grounding conductors, location of antenna-discharge unit, connection to grounding electrodes, and requirements for the grounding electrode. See Fig. A.

NEC — NATIONAL ELECTRIC CODE

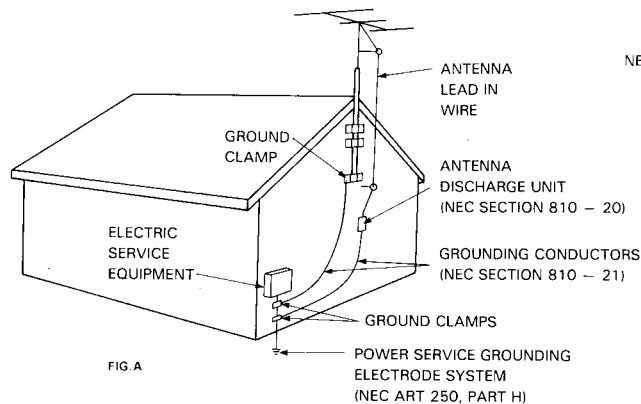

FIG. A

CONTENTS

<p>Precautions 4</p> <p>Features and Functions of the CLD-V510 5</p> <p>Accessories 6</p> <p>Types of Discs that can be played with this Unit 7</p> <p>Care of Discs 9</p> <p>Connections 10</p> <p>To Watch a TV Broadcast 15</p> <p>Names and Functions of Front Panel Components 16</p> <p>Names and Functions of remote Control Unit Components 18</p> <p>Remote Control Operations 19</p> <p>Before starting Karaoke Play 20</p> <p>Enjoying Laser/CD Karaoke - Basic Operation 22</p> <p>Convenient Functions for Karaoke Play - "Mood up" Functions 24</p> <p>Convenient Functions for Karaoke Play - For Practicing 25</p>	<p>Display Switching 26</p> <p>To Play an LD, CDV or CD 28</p> <p>To Search for a Particular Passage (Search using fast forward or fast reverse - Manual Search) 32</p> <p>To Search for a Particular Chapter/Track (Chapter (Track) Search/Chapter (Track) Skip) 33</p> <p>To Search for a Particular Time/Frame (Time Number Search/Track Time Search/ABS Time Search/Frame Number Search) 34</p> <p>Extra Playback 35</p> <p>To Repeatedly Play a Desired Passage (Repeat Playback) 36</p> <p>To Play Only the Desired Chapters/Tracks (Program Playback) 38</p> <p>Troubleshooting 40</p> <p>Specifications 45</p>
--	--

CAUTION

- Use of controls or adjustments or performance of procedures other than those specified herein may result in hazardous radiation exposure.
- The use of optical instruments with this product will increase eye hazard.

[For Canadian model]

This digital apparatus does not exceed the Class B limits for radio noise emissions from digital apparatus set out in the Radio Interference Regulations of the Canadian Department of Communications.

- This player may be used with LaserVision Discs, Compact Discs, and Compact Discs with Video bearing the following symbols:

(LASERDISC SYSTEM)/(LaserVision Disc)*



This is the unified symbol mark of LASERDISC (LaserVision videodisc).

* LaserVision players and discs which bear this symbol and use the same television system, are mutually compatible.

(Compact Disc)



(**CD VIDEO SYSTEM)



(3-inch Compact Disc)



** A Digital Sound with Multi Audio Discs (CD VIDEO LD) are referred to as CD Video discs. CD Video discs are recorded with subcodes, which are the non-audio recordings of TOC data such as track numbers, index numbers, etc. However, there are some discs without these marks.

Only one disc can be loaded at any one time. Loading a LaserVision Disc, a Compact Disc, a 3" Compact Disc or a Compact Disc with Video on top of one another may result in breakdown, or in scratching of the discs. Please only load one disc at a time.

This player is to be used exclusively with the NTSC color system. Please use NTSC LaserVision Disc or NTSC Compact Disc with Video only. PAL and SECAM system discs cannot be used with this player.

Note to CATV system installer

This reminder is provided to call the CATV system installer's attention to Article 820-22 of the NEC that provides guidelines for proper grounding and, in particular, specifies that the cable ground shall be connected to the grounding system of the building, as close to the point of cable entry as practical.

PRECAUTIONS

If it becomes necessary to transport or ship this unit in the future, be sure to first remove the disc (if present), retract the disc table to its closed position, turn the power off and disconnect the power cord.

INSTALLING THE PLAYER

- Place the player on a stable platform next to the television and stereo system to be used with the player.
- When using the player with a stereo system, your speakers should be placed away from your television (or TV monitor).
- Do not place heavy objects such as a television or TV monitor on top of the player.
- Do not place the player on top of your TV set or TV monitor. Also, keep the player away from devices such as cassette decks which are sensitive to magnetic fields.

When FM or AM stations are being received, signal noise may be generated if the player is turned on. Turn off the player when not in use. Also, if there is signal noise when receiving radio stations with an indoor antenna, adjust the position or direction of the antenna.

INSTALL THE PLAYER IN A WELL VENTILATED PLACE AWAY FROM HEAT AND HUMIDITY

Do not install the player in a location subject to direct sunlight, or near a stove or radiator etc. This could adversely affect the cabinet and internal components. Also avoid installing the player in a humid or dusty location. This could result in a malfunction or accident. Do not install near a cookstove where the player could be affected by smoke, steam, or heat.

AVOID SOURCES OF HEAT

Do not put the player on sources of heat, such as an amplifier. When installing with audio components on a rack, avoid components that generate heat, by placing the player below such components where there is adequate ventilation and not much dust. Avoid placing the player on surfaces such as shaggy carpets, beds, and sofas which may block ventilation under the player and cause damage.

CAUTIONS FOR AUTOMATIC LOADING OPERATIONS

Since this player has an automatic loading construction, use the key on the player or the remote control unit for opening and closing of the disc table. To avoid damage, be careful not to apply any force to the moving disc table.

STRIPE PATTERNS APPEARING ON A TV PROGRAM

Stripe patterns may appear during a TV program if the player unit is turned on, depending on the quality of reception of the TV station. This is neither a malfunction of the television nor the player. If stripes appear while watching the TV, or when watching the TV for long periods of time, turn the player off.

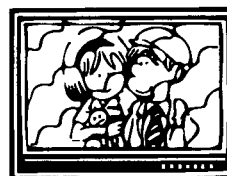

CONDENSATION

Moisture will form in the operating section of the player if the player is brought from cool surroundings into a warm room or if the temperature of the room rises suddenly. When this happens, player's performance will be impaired.

To prevent this, let the player stand in its new surroundings for about an hour before switching it on, or make sure that the room temperature rises gradually.

The same, symptoms of condensation may be caused during summer, if the player is exposed to the breeze from an air conditioner. In such cases change the location of the player.

POWER-CORD CAUTION

Handle the power cord by the plug. Do not pull out the plug by tugging the cord and never touch the power cord when your hands are wet as this could cause a short circuit or electric shock. Do not place the unit, a piece of furniture, etc., on the power cord, or pinch the cord. Never make a knot in the cord or tie it with other cords. The power cords should be routed such that they are not likely to be stepped on. A damaged power cord can cause fire or give you an electrical shock. Check the power cord once in a while. When you find it damaged, ask your nearest PIONEER authorized service center or your dealer for a replacement.

CLEANING CARE

Use a soft, dry cloth for cleaning. For stubborn dirt, soak the cloth in a weak detergent solution; wring well first and wipe. Use a dry cloth to wipe it dry. Do not use any volatile agents such as benzine or paint thinner, as it may damage the surface of the player.

FEATURES AND FUNCTIONS OF THE CLD-V510

Rich Variety of Karaoke Functions

Direct Selection Function Enables You to Directly Select the Song You Wish to Sing

Using the MUSIC SELECTORs on the front panel, you can select any song up to the 20th song by simply pressing a single button.

Two Independent Microphone Systems Enable You to Separately Adjust the Sound Volume for Each Mike

Since two independent microphone systems are provided, you can independently adjust the level for each microphone.

Vocal Partner Function Replaces the Original Vocal Sound with Your Own Voice

With multiplexed karaoke discs, if you press VOCAL PARTNER and sing into the microphone, the original vocals will be cut out and replaced with your own voice.

Once More Function Enables You to Quickly Repeat the Section You Just Sang

If you press ONCE MORE once, playback returns to a point approximately 5 seconds before the current location in the song.

One-Song Pause Function

Playback automatically pauses after one song selected is played.

LD (LaserVision Disc) Playback Functions

Program Playback

Up to 24 chapters can be selected from a disc and played in any desired order.

Multi-speed Playback and Still Frame Playback (CAV discs only)

The playback speed can be varied in 9 steps in both the forward and reverse directions. Still frame playback and Frame Advance Playback (forward/reverse) are also available.

Repeat Playback

Five repeat modes - Memory Repeat, 1-chapter Repeat, One-side Repeat, Section Repeat and Program Repeat - are available.

Time/Frame Search

Any desired scene can be searched for by specifying its time/frame number.

CD (Compact Disc) Playback Functions

Program Playback

Up to 24 tracks can be selected from a disc and played in any desired order.

Repeat Playback

Five repeat modes - Memory Repeat, 1-Track Repeat, All-track Repeat, Section Repeat and Program Repeat - are available.

Track-Time Search

Any desired point can be searched for by specifying track time on a specified track.

CDV (Compact Disc with Video) Playback Functions

* The video part (the section of the disc containing both video and audio) is played first.

Video Part:

The same functions available for LD (CLV) playback can be used.

Audio Part:

The same functions available for CD playback can be used.

Other Features

Auto Loading and Automatic Disc Discrimination Functions

This unit has a built-in motor-driven auto loading mechanism which automatically opens and closes the disc table and makes disc loading easy.

Also, after a disc is placed on the table and the table is retracted into the player, the player automatically detects which type of disc (LD, CD, or CDV) is loaded.

Zero-Cross Distortion-Free D/A Converter with Double-Step Noise-Shaper

Digital-to-analog conversion is smoother than ever. In particular, this converter is designed to eliminate zero-cross glitching noise and improves linearity in lower levels, with the noise shaping technology doubly applied at digital filter and digital-to-analog conversion steps, all for smoother and more accurate D/A signal conversion. The result is deep, clear sound with sharp image localization.

Compatibility with Many Disc Types and Sizes

In addition to conventional LDs (12-inch, 8-inch), CDs (5-inch), and CDV discs (5-inch), the PLAYER can play thin-type 8-inch LDs and 3-inch CD singles without an adapter.

ACCESSORIES

When unpacking the player, first check to make sure that all of the accessories listed below are supplied.

- Remote control unit
- Size "AAA" (IEC R03) dry cell battery x 2

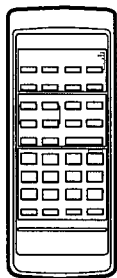
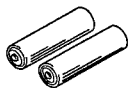

- Antenna adaptor
(75Ω/300Ω → 75Ω F-type plug)
Use to connect a VHF antenna cable to the antenna terminal of the player.

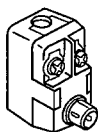

- Audio cord
(Pin plug x 2 ↔ Pin plug x 2)
Use to connect the player to a stereo amplifier etc.

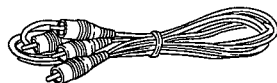

- Video cord
(Pin plug ↔ Pin plug)
Use to connect the player to a color monitor etc.

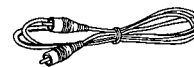

- RF antenna cable
(J-type plug ↔ J-type plug)
Use to connect the player to a TV set.

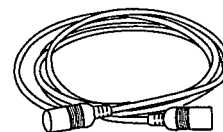





- Operating instructions
- Warranty card



TYPES OF DISCS THAT CAN BE PLAYED WITH THIS UNIT

This unit is a CD VIDEO SYSTEM (*1) compatible player which can play CDs, CDV discs, and LDs.

The five disc types listed in the table below can be played with this unit.

*The marks shown in the left column are printed on the labels and jackets of the corresponding discs.

Mark	Disc	Size	Number of recorded sides	Audio recording system	Video recording system	Other
	CD (Compact Disc) Single	3-inch	One side	Digital (20 minutes max.)		TOC (*2)
	CD (Compact Disc)	5-inch	One side	Digital (74 minutes max.)		TOC
	CDV (CD with Video)	5-inch	One side	Digital (20 minutes max.)	CLV (*3) (5 minutes max.)	TOC *
	CD VIDEO LD (*4)	12-inch, 8-inch	Two sides, one side	Digital/analog	CAV (*5) CLV	TOC **
	LD (LASERDISC/ LaserVision Disc)	12-inch, 8-inch	Two sides, one side	Digital/analog (*6) or analog only	CAV, CLV	

* There are some discs marked with the  mark instead of the  mark.

** There are some discs without the  mark.

LD GLOSSARY

Chapter number

Chapter numbers are used to indicate the boundaries of the sections on a disc, similar to the "chapters" in a book. If chapter numbers are recorded on a disc, it is so indicated on the jacket of the disc, etc. Chapter numbers can be used to search for desired chapters (Chapter Search).

Frame number

Frame numbers are the numbers assigned to each picture frame on a CAV (standard play) disc. Frame numbers can be used to search for desired frames (Frame Search).

Time number

Time numbers indicate the time elapsed from the beginning of a CLV (extended play) disc. Time numbers can be used to search for desired scenes (Time Search).

CDV/CD GLOSSARY

Track number

Track numbers indicate the boundaries of the sections, or "tracks", on a disc. Track numbers are assigned consistently throughout the audio part and video part of a CDV disc. Track numbers can be used to search for desired tracks (Track Search).

TOC (*2)

Every CD/CDV-type disc is provided with a section called TOC (Table Of Contents) at the beginning of the disc. The TOC section is just like the table of contents of a book, and contains information on the contents (number of tracks, playing time, etc.) of the disc.

- Some LD discs are also provided with a TOC section.

CD VIDEO SYSTEM (*1)

The CD VIDEO SYSTEM is the standard name for the "optical video disc with digital audio" system that encompasses both LDs and CDV discs.

The following mark is the standard mark for the CD VIDEO SYSTEM and is found on all players and discs which conform to the CD VIDEO SYSTEM format.

The following systems are included in the CD VIDEO SYSTEM:



- CDV (CD VIDEO CDV) discs
- LaserVision Discs (CD VIDEO LDs) containing digital sound with sub-codes
- Compatible players which can play CDs and CDV discs
- Compatible players which can play CDs, CDV discs, and LDs

CD VIDEO LDs (*4)

A CD VIDEO LD is an LD with digital audio which is encoded with sub-codes (data such as TOC and track number data, excluding audio and video signals).

LDs (LASERVISION DISCS)

With this unit, only play LaserVision discs which bear the following mark.

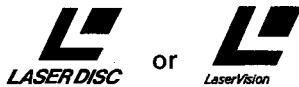

This mark is the standard mark for LaserVision video discs. Players and discs which bear the LaserVision mark are mutually compatible as long as they conform to the same television system.

Two types of standard LaserVision disc are available — standard play (CAV) (*5) discs and extended play (CLV) (*3) discs — which differ with respect to their signal recording systems.

CAV (*5) DISCS

The jackets and labels of these discs are marked with a "Standard Play Disc CAV" or "Standard Play" indication.

Frames are recorded on these discs at a ratio of one frame per disc revolution, and the discs are played at a fixed rotational speed (CAV = Constant Angular Velocity) of 1,800 rpm. This system is well suited to special playback modes such as still frame playback and multi-speed playback. One side of a CAV disc can have a playback time of up to 30 minutes (for a 12-inch disc), which is equivalent to 54,000 frames. Each frame — from frame 1 to frame 54,000 — is encoded with its own frame number.

* Playback time varies according to the contents of the disc.

CLV (*3) DISCS

The jackets and labels of these discs are marked with a "Extended Play Disc CLV" or "Extended Play" indication.

Signals are recorded on these discs at a constant linear velocity (CLV), and the rotational speed during playback varies from 1,800 rpm for the innermost track to 600 rpm for the outermost track. As a result, one side of a CLV disc can have a playback time of up to 60 minutes (for a 12-inch disc), which is twice as long as a standard play (CAV) disc. CLV discs are encoded with time numbers which correspond to the elapsed play time from the beginning of the disc.

* Playback time varies according to the contents of the disc.

LASERVISION DISCS WITH DIGITAL AUDIO (*6)

The jackets and labels of these discs bear the following mark.



These are LaserVision discs which contain digital audio signals in addition to conventional analog audio signals. This feature allows the high image quality of LaserVision discs to be enjoyed together with the superior quality of digital sound. The digital and analog audio signals are recorded on the disc using different frequency bands.

LASERVISION DISCS WITH DIGITAL SOUND AND MULTI AUDIO

The jackets and labels of these discs bear the following mark.

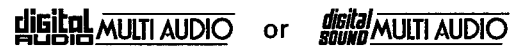

These are LaserVision discs in which the recorded digital and analog audio signals differ in content. This allows the user to enjoy two different audio soundtracks by switching between the digital and analog sound.

CDV (COMPACT DISC WITH VIDEO) DISCS

These are compact discs which also contain video signals. Of the total 25-minute (max.) playback time of a CDV disc, up to 20 minutes is encoded with conventional CD digital audio signals (the "audio part"). The remaining up to 5 minutes is encoded with both video and digital audio signals (the "video part").

CARE OF DISCS

How to hold discs

When loading or removing discs, try not to touch their playing surfaces.

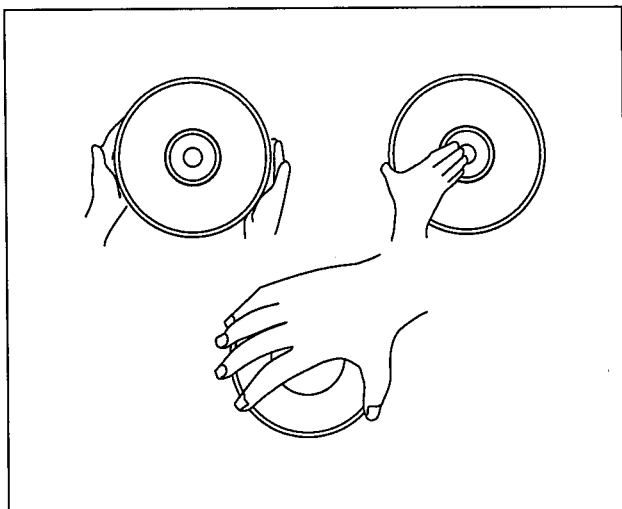

Cleaning

Fingerprints or other dirt on the disc may affect sound and picture quality.

To clean your discs, use a soft clean cloth to wipe them. If necessary, moisten a soft cloth with diluted neutral detergent to remove heavy dirt or fingerprints.

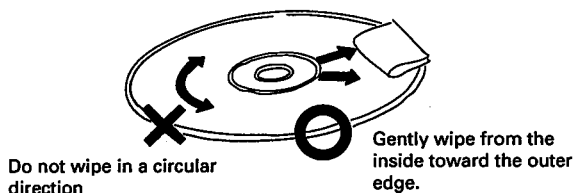

Discs may not be cleaned with record cleaning sprays, or static prevention sprays, etc. Also do not use volatile liquids such as benzine, or thinner, etc.

NEVER PLAY CRACKED OR WARPED DISCS.

■ The disc revolves on the player at a high speed when it is played. Never play a cracked, scratched or warped disc. This may damage the player or cause it to malfunction.

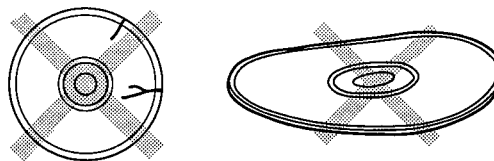

After using discs, store them upright

After playing a disc, always remove it from the player and return it to its jacket. Then store it standing upright away from heat and humidity.

- Store discs carefully. If you store discs at an angle, or stacked on top of each other, discs may become warped even when in their jackets.
- Do not leave discs in locations such as the seat of car, which may become excessively hot.

If an LD disc is warped...

If an LD disc is warped, put the disc into its protective envelope, and then place it between two flat plates of glass. Then place heavy books on top of the plates so that approximately 4 to 5 kgs (10 lbs) is applied. Leave the disc like this for a day or so. This may correct the warp.

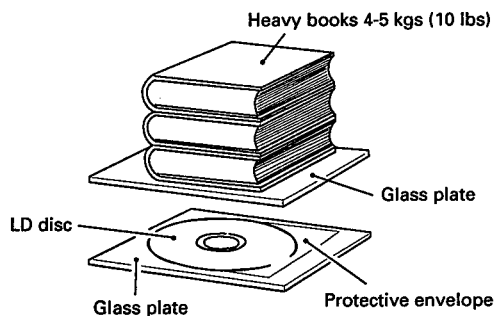

CAUTION WHEN USING THE DISC

All rights reserved.

Unauthorized public performance, broadcasting or copying is a violation of applicable laws.

CONNECTIONS

USING TELEVISION WITH AUDIO AND VIDEO JACKS

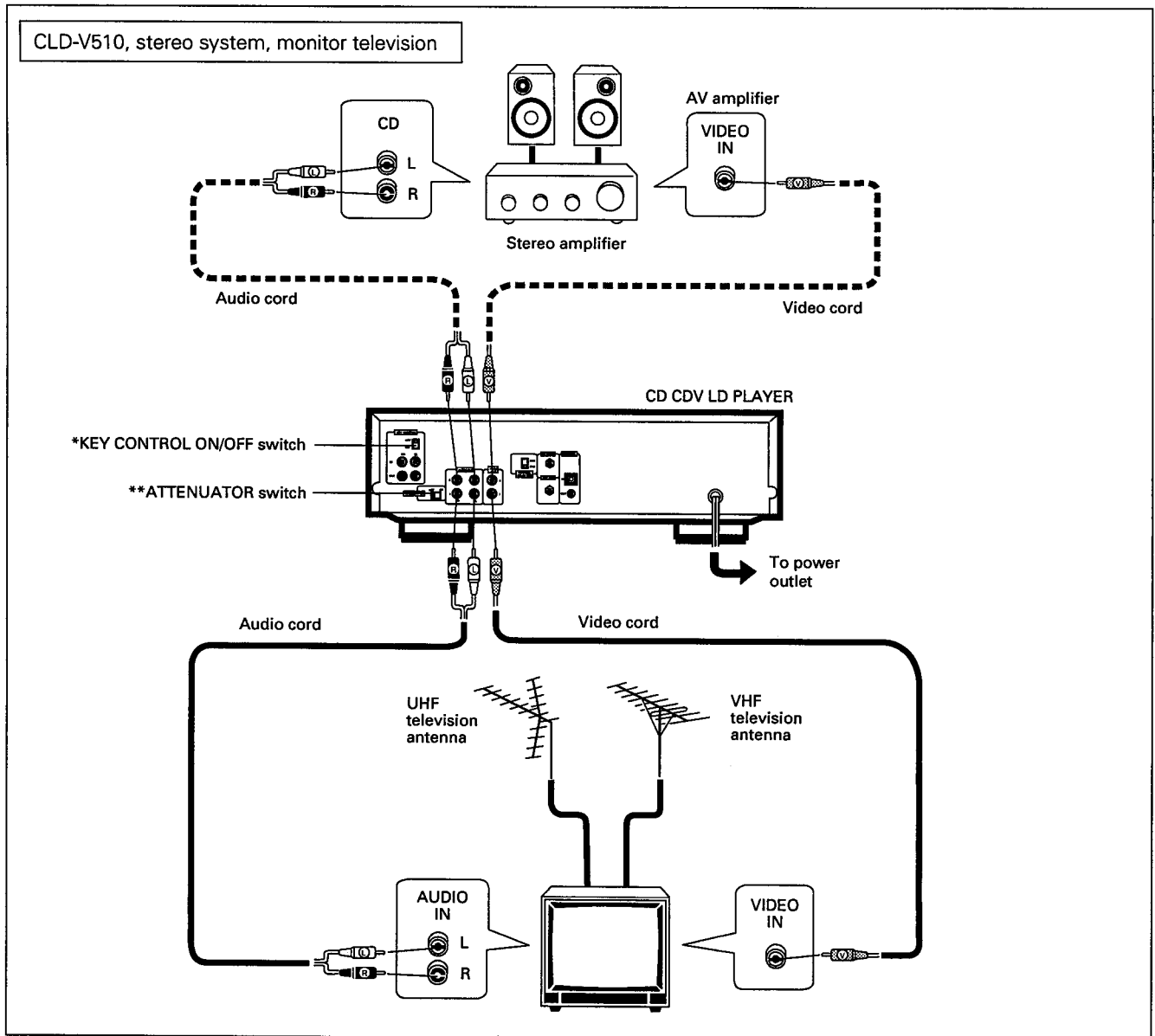

- Connect the VIDEO OUT jack of the player to the video input jack of the monitor television.
- Connect the AUDIO OUT jacks to the stereo amplifier AUX, CD, VDP or other jacks, except the PHONO input jacks. The television speakers can also be used by connecting the television audio input jacks and the player AUDIO OUT jacks, however connection to a stereo amplifier is recommended to obtain superior audio playback quality for Compact Discs and LaserVision Discs.
- Do not change the television antenna and VCR connections.
- Combined system control is possible when a Pioneer television and audio/video stereo receiver are connected. Refer to page 14 for an explanation of the connection procedure.

*KEY CONTROL ON/OFF switch

When the player is connected with the separately sold key controller (e.g. KC-V170), set the KEY CONTROL ON/OFF switch to the ON position. Otherwise, set this switch to the OFF position. Refer to page 13 for an explanation of the connection with the key controller.

**ATTENUATOR switch

When the television speakers are used, the sound may be distorted. In this case, set ATTENUATOR to ON to reduce the distortion.

USING TELEVISION WITHOUT AUDIO AND VIDEO JACKS

CLD-V510, regular television, stereo system, (VCR)

The numbers are explained on the next page.
Make the connections in this order.

3

CHANNEL SELECTOR switch
Set the channel to a vacant television broadcasting channel (page 13).

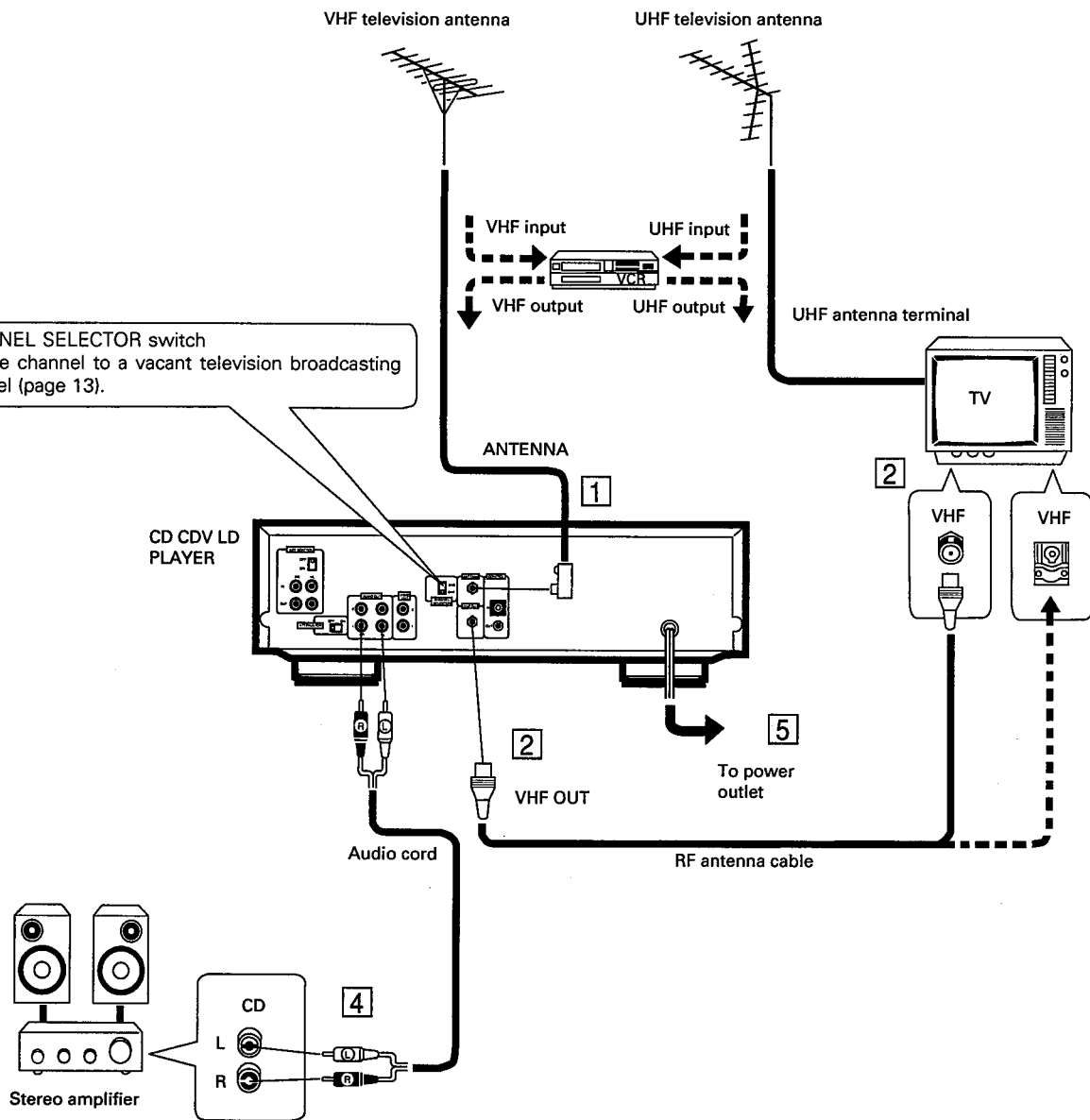

When the sound from a LaserVision Disc or Compact Disc is output from a television speaker it becomes monaural sound. (This is the same as stereo television).

NOTE:

- *Stripe patterns may appear when a LaserVision Disc is played on a television. Move the antenna cable away from the power cord to avoid this.*

1 VHF TV ANTENNA CONNECTION

Detach the VHF antenna cable from the VHF antenna terminal of your TV set, and connect the cable to the ANTENNA terminal on the player.

If the end of the cable does not match the ANTENNA terminal, attach the accessory antenna adaptor, and plug the adaptor into the ANTENNA terminal.

Attach the antenna adaptor

<For 75Ω coaxial cable>

- ① Strip off the end of the cable as shown below.

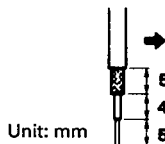

Unit: mm

- ② Remove the cover.

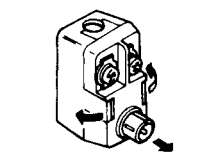

Pry open both latches and remove the cover.

- ③ Remove the lead from the slit of the fork terminal and insert into the slit of the case.

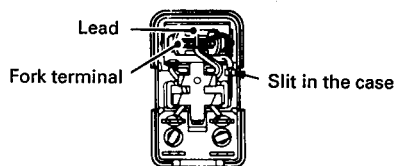

- ④ Connect the cable.

Tighten both sides with pliers.

Tighten both sides with pliers.

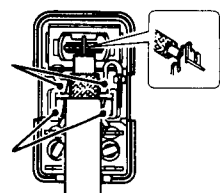

- ⑤ Put the cover back on.

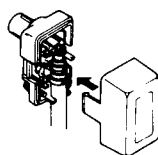

<For 300Ω parallel feeder>

- ① Strip off the insulation of the feeder wire as shown.

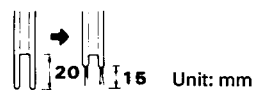

Unit: mm

- ② Connect the wire to the 300Ω terminal.

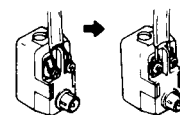

Loosen the screws, twist the wire around and tighten the screws.

2 CONNECTING TO YOUR TV SET

Connect the VHF OUT terminal of the player to the 75Ω VHF antenna terminal of your TV set with the accessory RF antenna cable. If the VHF antenna terminal of your TV set is not an F-type jack, modify one end of the cable.

NOTES:

- Push the plug in firmly. If the plug is not properly inserted, it may result in snow on the screen or noise.
- The shape of the VHF antenna input terminal and the method of connecting the antenna cable may differ from one TV set to another. For details, please refer to your TV instruction manual.

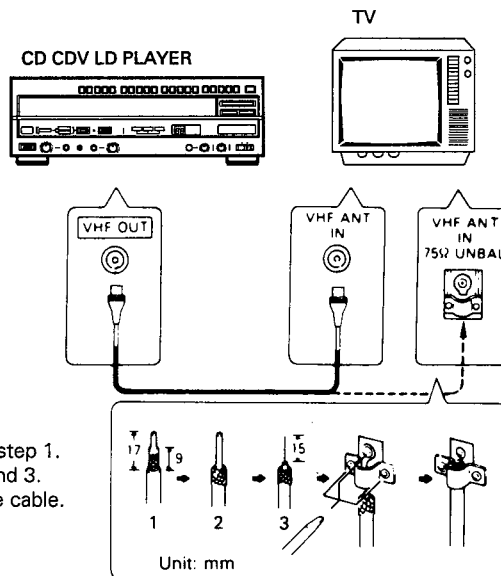

75Ω coaxial cable preparation

1. Strip the end of the cable as shown in step 1.
2. Prepare the end as shown in steps 2 and 3.
3. Loosen the three screws and insert the cable.
4. Tighten the three screws firmly.

3 SET THE CHANNEL SELECTOR SWITCH

If channel 3 is not being used for broadcast in your area, set the channel selector switch to channel 3. If channel 4 is not being used, set the switch to channel 4. The setting will be the disc playback channel.

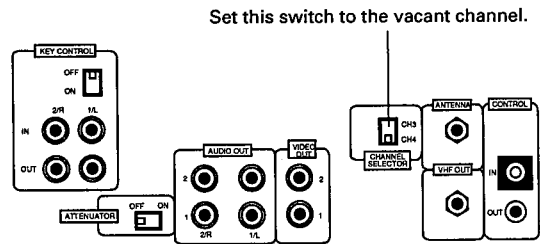

4 CONNECTING TO YOUR STEREO AMPLIFIER

Connect the AUDIO OUT jacks of the player to the AUX or CD input jacks of your stereo amplifier.

NOTE:

- Do not connect these terminals to your amplifier PHONO input jacks.

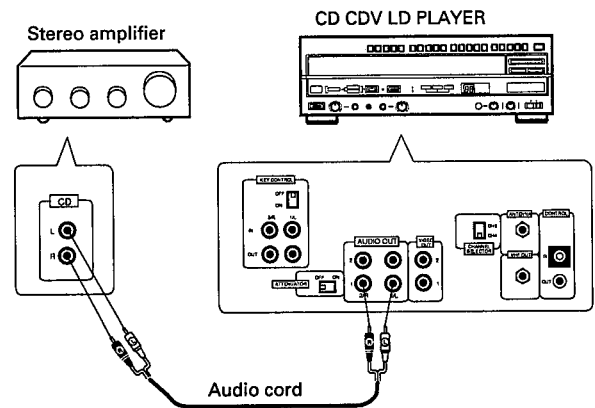

5 PLUG THE POWER CORDS INTO AC OUTLET

Plug the AC power cords of the player, stereo amplifier and TV set into an AC outlet.

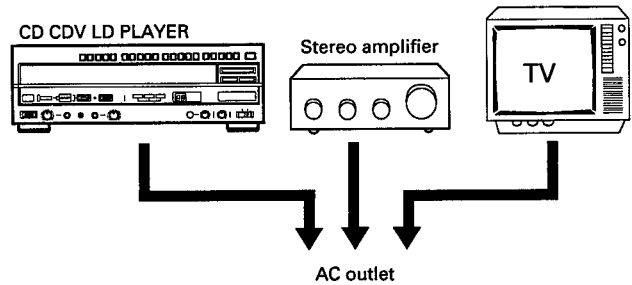

CONNECTION WITH THE KEY CONTROLLER, e.g. KC-V170 (optional).

Connect the KEY CONTROL OUT jack of the CD CDV LD PLAYER with the AUDIO INPUT jack of the KEY CONTROLLER.

Connect the IN jack with the AUDIO OUTPUT jack. Set the KEY CONTROL ON/OFF switch to the ON position.

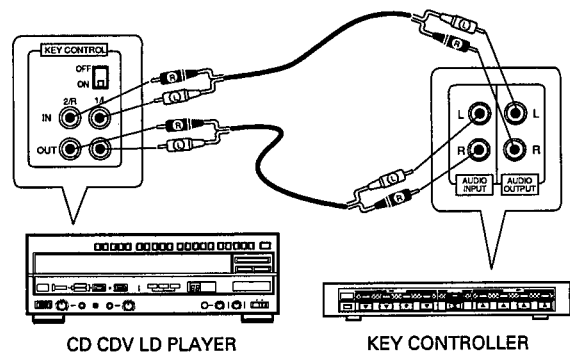

SYSTEM REMOTE CONTROL CONNECTION

WHEN COMBINED WITH OPTIONAL PIONEER PROJECTION MONITOR (or COMPONENT DISPLAY)

Connect the VIDEO OUT jack of the player to the video input jack of the projection monitor (or component display), and connect the AUDIO OUT jacks of the player to the audio input jacks of the projection monitor (or component display).

System Control

By connecting the CONTROL IN  jack of the player to the remote jack of the projection monitor (or component display), the system can be controlled by the remote control unit of the player at the remote control sensor of the projection monitor (or component display).

- Use a commercially available cord with mini-plugs for the connection.

Please also refer to the operating instructions for the projection monitor (or component display).

NOTE:

When system control connections have been made, the player cannot be directly controlled by the remote control unit. To operate the player, aim the remote control unit at the projection monitor (or component display).

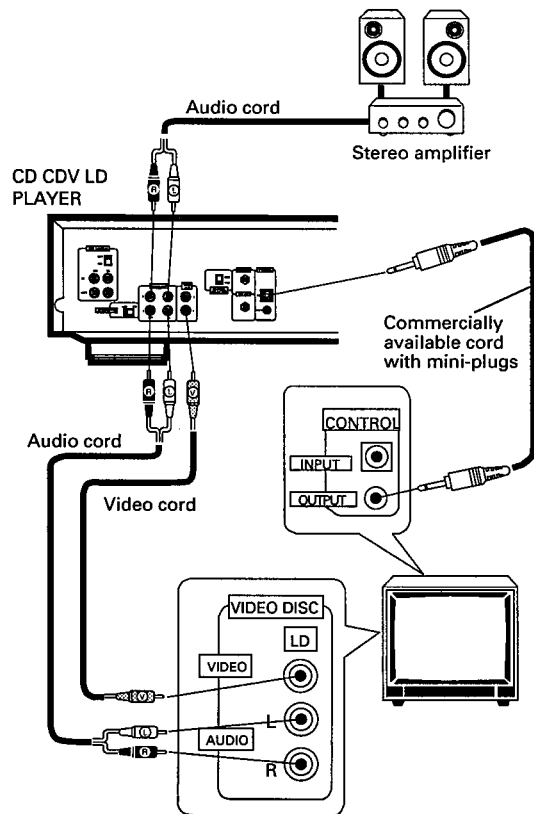

PERFORMING SYSTEM CONTROL WHEN THE PLAYER IS COMBINED WITH A PRODUCT THAT HAS THE MARK

System control can be performed when the player is combined with an optional AV control center, which can provide centralized control of Pioneer products with the  mark.

Connect the VIDEO OUT jack of the player to the video input jack of the AV control center and connect the AUDIO OUT jacks of the player to the audio input jacks of the AV control center.

Connect the CONTROL OUT jack of the AV control center to the CONTROL IN  jack of the player using a commercially available cord with mini-plugs.

- For details concerning the connection and operation methods, please refer to the operating instructions for the AV control center.

NOTE:

- When a connecting cord has been connected to the CONTROL IN jack, direct control of the player with the remote control unit is not possible. Operate the player with the remote control unit by aiming it at the AV control center.

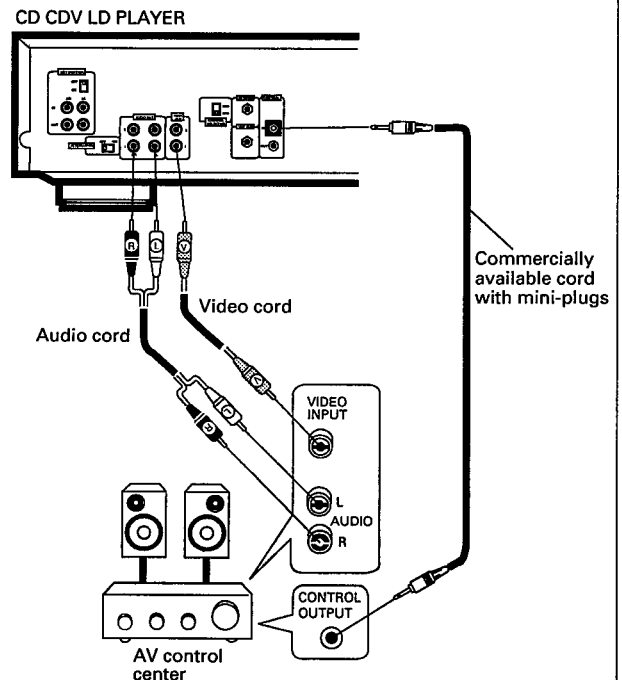

TO WATCH A TV BROADCAST

When a VHF TV antenna has been connected to your TV via the player's ANTENNA terminal, in accordance with the connection example given in these instructions (page 11), TV broadcasts can be received normally by proceeding in one of the following two ways:

■ **By switching power of the player off**

Before switching off power, press STOP to stop disc playback.

■ **By pressing TV/LD of the remote control unit, TV mode can be selected.**

* To return to disc playback, press TV/LD again.

In either case the signals from the VHF antenna are fed to the TV set via the player.

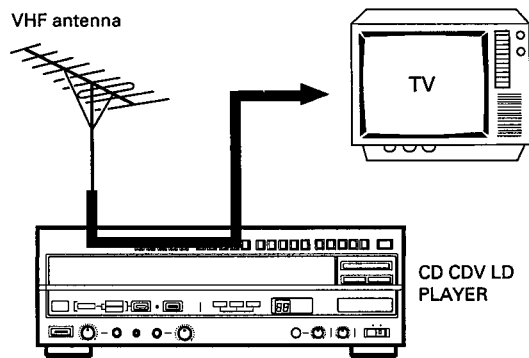

Press TV/LD of the remote control unit, or turn off power.

NOTE:

In an area where the TV broadcast signal is weak, slanting stripes may appear on the TV screen when TV/LD is pressed to receive a TV broadcast. This does not always indicate a problem. The stripes should be eliminated by turning power of the player off.

In such cases, or when you wish to watch TV for a long period of time, we recommend that you turn off the power switch of the player.

When using a TV set with video and audio input jacks.

When using the video input jack of your TV, switch to the broadcast using the controls of your TV.

NAMES AND FUNCTIONS OF FRONT PANEL COMPONENTS

- Most of the buttons on the front panel are used for Karaoke play.
- A detailed description is provided on the indicated page(s).

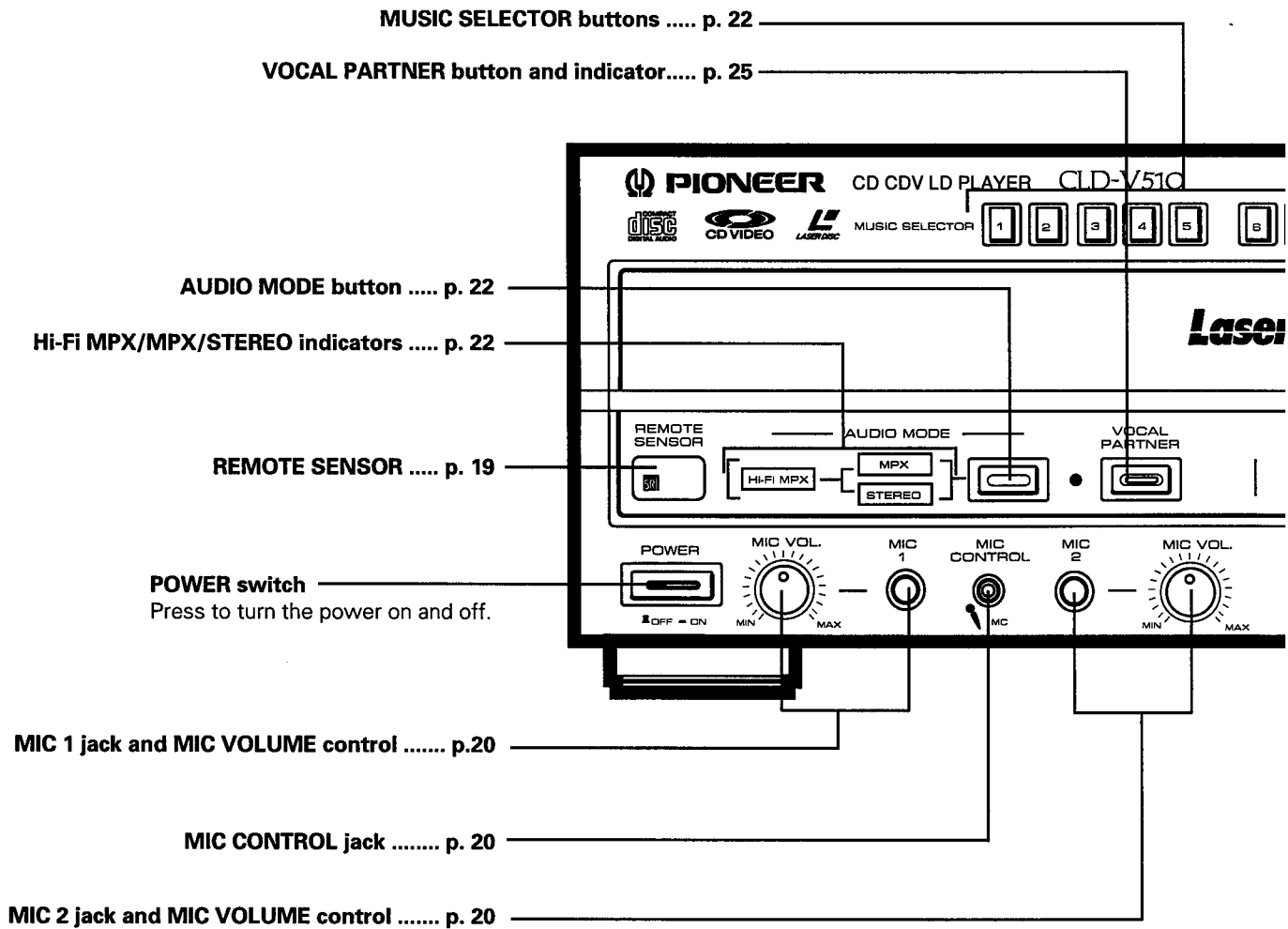

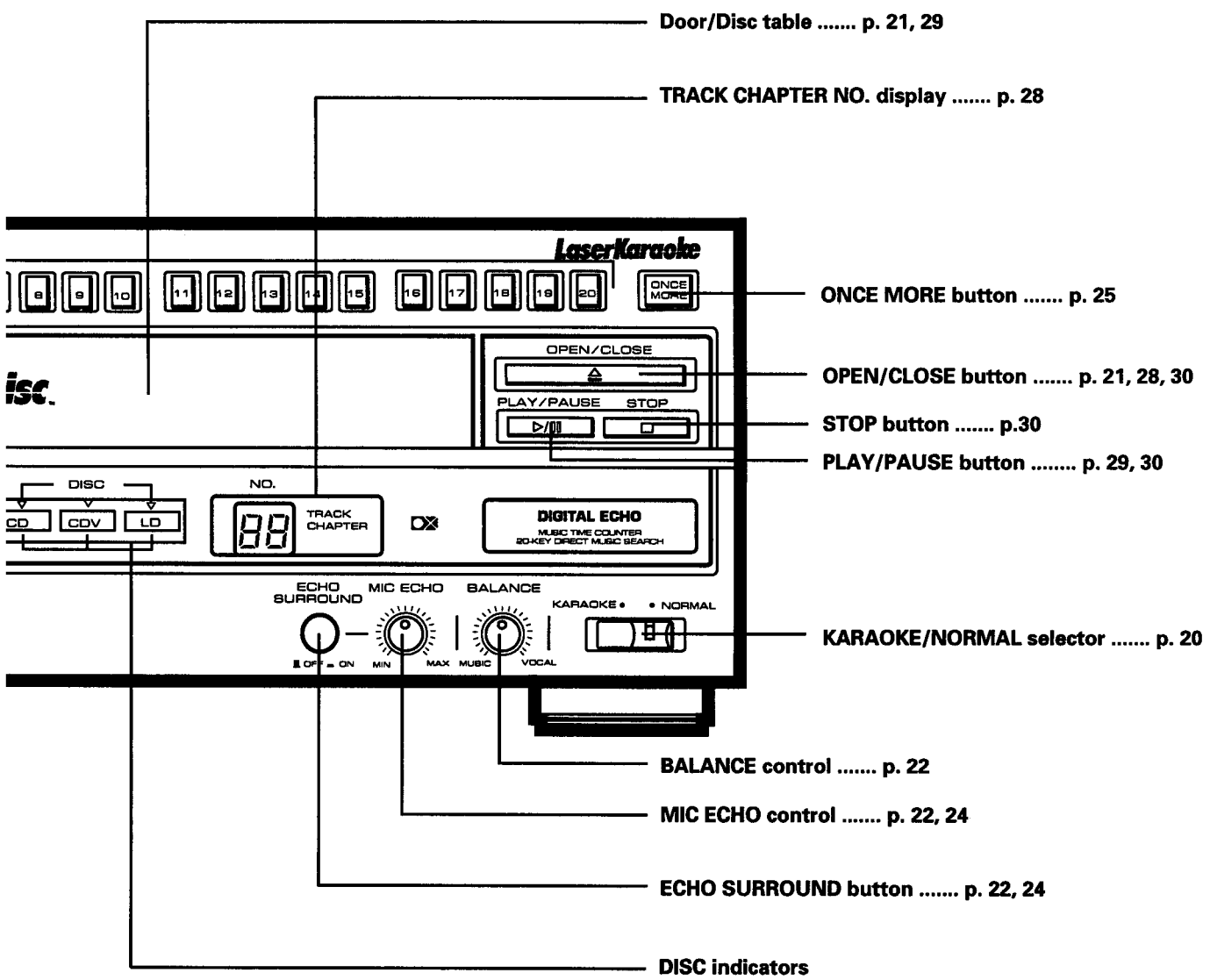
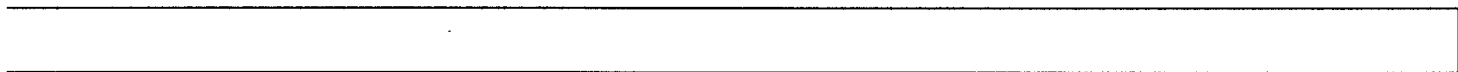

NAMES AND FUNCTIONS OF REMOTE CONTROL UNIT COMPONENTS

- A detailed description is provided on the indicated page(s).
- Remote control keys with the same names or marks as buttons on the front panel of the player control the same operations as the corresponding front panel buttons.
- Most of the keys on the remote control unit are used for Disc playback explained from on page 28.

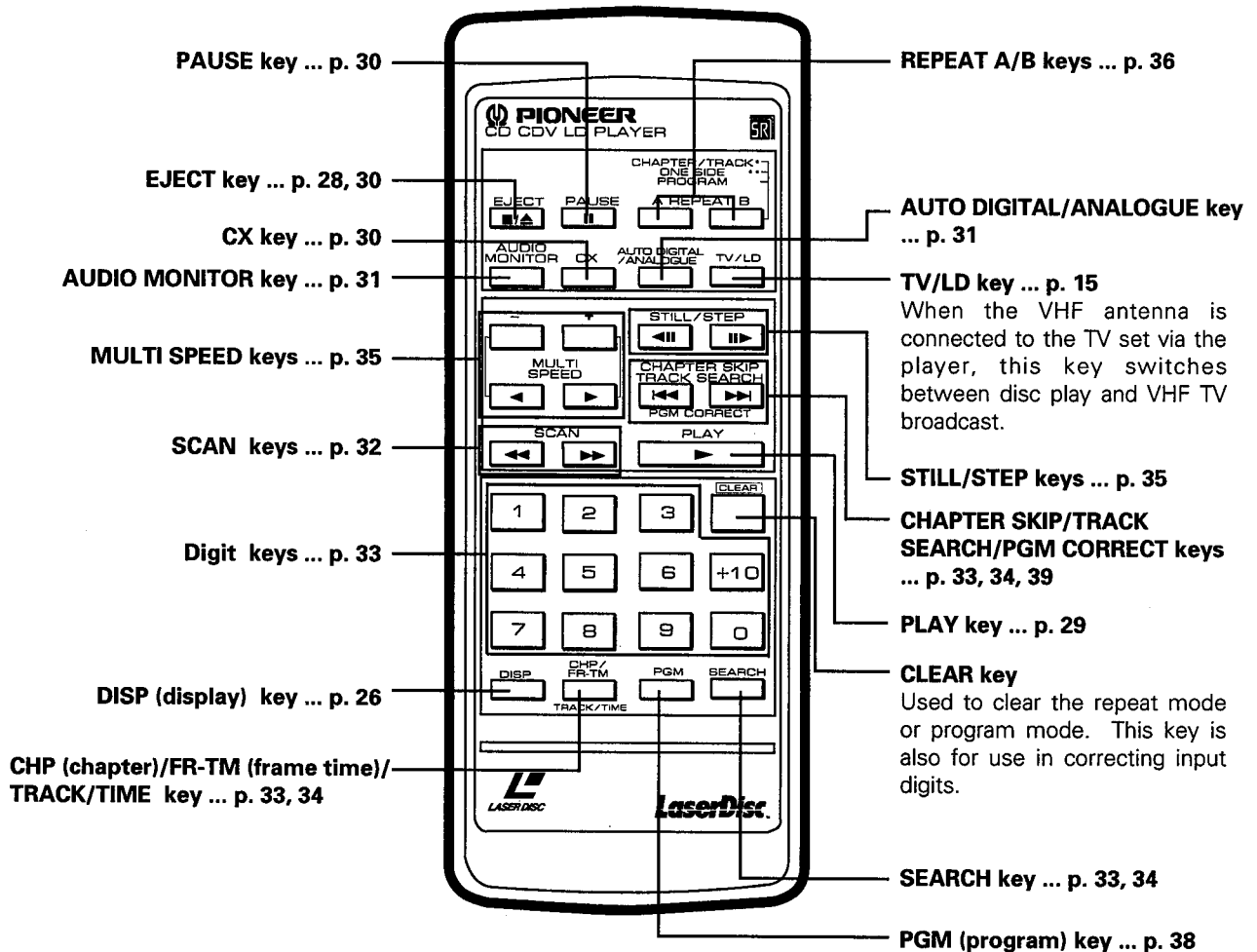

REMOTE CONTROL OPERATIONS

INSERTING BATTERIES INTO THE REMOTE CONTROL UNIT

1. Open the battery compartment cover on the back of the remote control unit. The cover should open easily if you press on it with your thumb while sliding it in the direction of the arrow.
2. Take out the two accessory size "AAA" (IEC R03) dry cell batteries, and insert them into the battery compartment in accordance with the display (+, -) inside the compartment.
3. Close the cover of the battery case.

Incorrect use of batteries may cause leakage or rupture. Always be sure to follow these guidelines:

- A. Always insert batteries into the battery compartment correctly matching the positive (+) and negative (-) polarities, as shown by the display inside the compartment.
- B. Never mix new and used batteries.
- C. Batteries of the same size may have different voltages, depending on brand. Do not mix different brands of batteries.

When operating the remote control unit, point the unit's infrared signal transmitter at the remote control receiver (REMOTE SENSOR) on the front panel of the player. The remote control unit can be used within a range of about 7 meters (23 feet) from the remote sensor, and within angles of up to about 30 degrees.

NOTE:

If the remote control sensor window is in a position where it receives strong light such as sunlight or fluorescent light, control may not be possible.

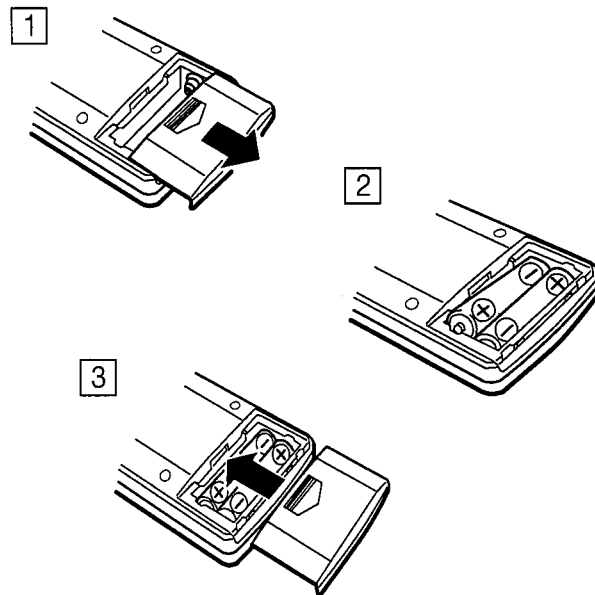
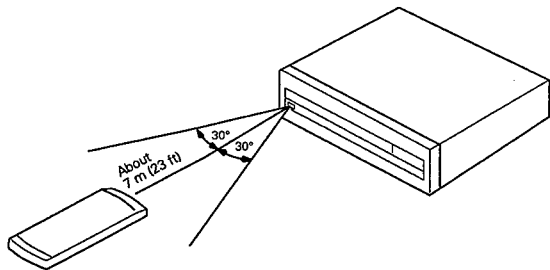

NOTE FOR USING THE REMOTE CONTROL UNIT

- If a plug is connected to the CONTROL IN terminal at the rear of the player, remote control operations cannot be done with the remote control unit aimed at the player's remote control sensor. Aim the remote control unit at the AV control center or the component display's sensor instead.
- If there is any obstacle between the remote control unit and the player, or if the unit is held at too large an angle relative to the front panel of the player, the signal from the remote control unit will fail to reach the remote sensor.
- If the player is operating in the vicinity of other appliances generating infrared rays, or if other remote control devices using infrared rays are used near the player, the player may operate improperly. Conversely, if the player's remote control unit is operated in the vicinity of other appliances which use an infrared remote control device, the other appliance may operate improperly. If this should happen, change the place of installation so that improper operation does not occur.
- If the range of operation of the remote control unit becomes too short, replace the batteries.
- When the unit is not to be used for a long period of time (more than one month), remove the batteries to prevent them from leaking inside the compartment. If leakage occurs, wipe up the liquid inside the compartment and replace the batteries with new ones.
- Do not place books or other objects on the remote control unit, since they might depress the keys and run down the batteries.

BEFORE STARTING KARAOKE PLAY

- Turn on the power to the monitor TV and/or audio system.
- Before starting karaoke play, carry out the following operations in the sequence indicated below.

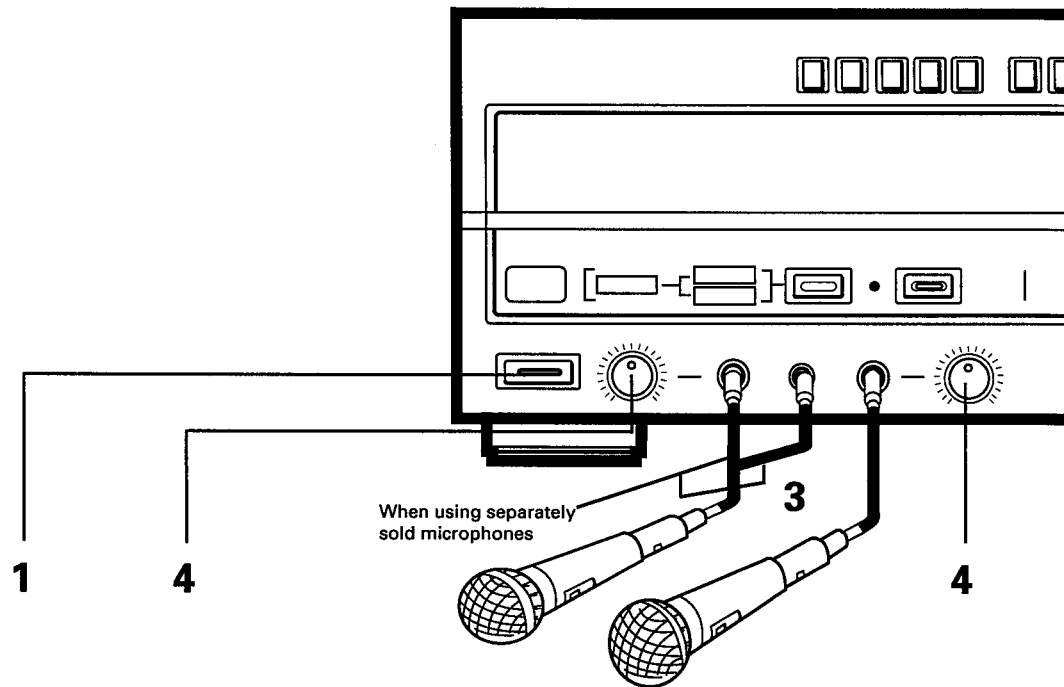

1

Turn on the power to the player.

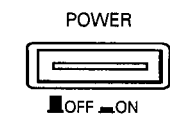

2

Set the player to KARAOKE mode.

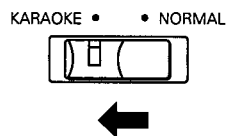

For karaoke play, always set this selector to KARAOKE to set the player to KARAOKE mode.

3

Connect and turn on the microphone(s).

- To MIC 1 or MIC 2.
- To MIC 1 and MIC 2 for duets.

About microphones

When using a separately-sold microphone such as the Pioneer Microphone DM-V161, connect the control-use miniplug to the player's MIC CONTROL (MC) jack.

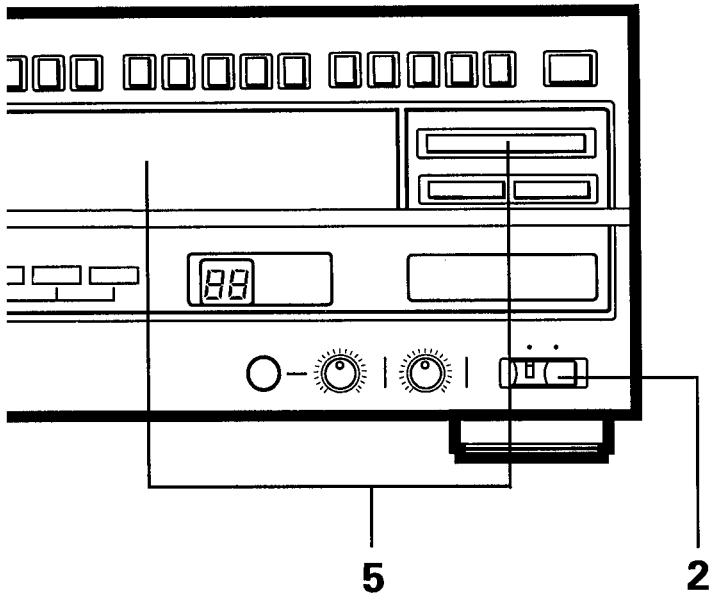

4

Adjust the microphone level.

For MIC 1

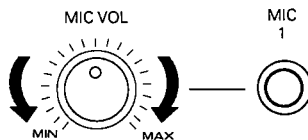

For MIC 2

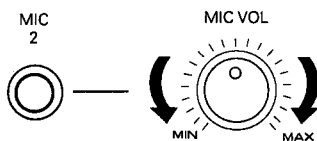

Adjust the microphone level while speaking into the microphone. (You can also adjust the level while singing during karaoke play.)

NOTE:

If howling (a high-pitched sound) occurs, decrease the microphone level, separate the microphone farther from the speaker(s), or lower the sound volume of the TV. (If using a stereo amplifier, lower the amplifier's sound volume.)

5

Load a disc.

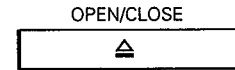

As shown in the following diagram, place the disc on the disc table in the groove corresponding to the size of the disc.

If the disc is not centered correctly on the disc table, the disc will not be played or the disc and/or the player may be damaged.

Always place the disc correctly according to the required disc size on the disc table.

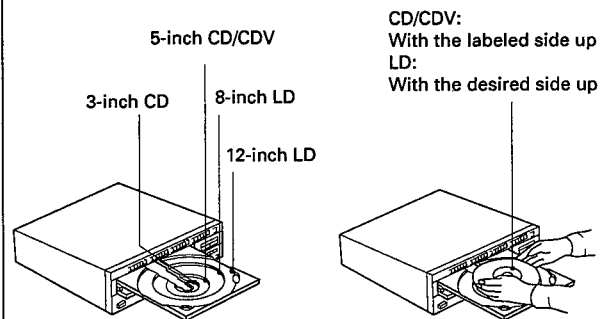

To avoid malfunctions, be especially careful about the following points.

- Do not place any object other than a disc on the disc table.
- Do not move the player while a disc is playing. This will cause the disc to be scratched.
- Be careful not to catch your finger in the disc table section while the disc table is being retracted into the unit. Also, be careful that children do not put their hands into the inside of the unit while the disc table is open. This may cause injury.

Precautions concerning disc loading

- Do not place more than one disc on the disc table. If two discs are placed one on top of the other on the disc table, discs may be scratched and/or malfunction may occur.
- With this unit, playback of all types of CD Video discs is carried out without the use of adapters. Therefore, do not use any type of adapter with this unit.

ENJOYING LASER/CD KARAOKE - BASIC OPERATION

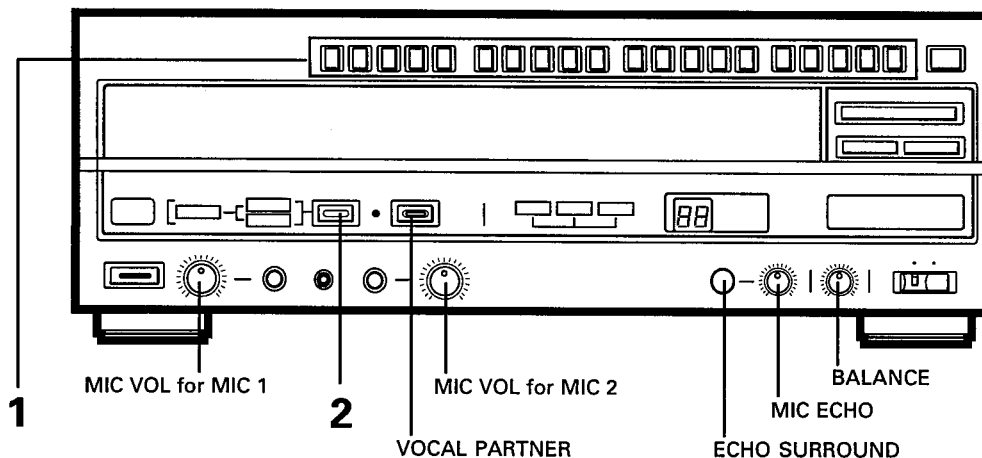

1

MUSIC SELECTOR



Select a song using the MUSIC SELECTOR buttons. (After one song is finished, select the next song using the MUSIC SELECTOR buttons.)

One-Song Pause Function:

Playback automatically pauses after one song is played. Select the next song using the MUSIC SELECTOR buttons. This function can operate only in KARAOKE mode.

To use the VOCAL PARTNER function (Multiplexed karaoke discs only):

1. Turn the BALANCE control to the VOCAL side.

2. Press VOCAL PARTNER so that the indicator lights.

When you sing into the microphone, your voice replaces the original vocals on the disc. This function is useful when practicing duets.

- Set the MIC VOL control(s), ECHO SURROUND and MIC ECHO to the desired positions. For echo adjustment, see page 24.
- Hi-Fi stereo multiplexed sound is possible when using a karaoke disc which bears **Digital MULTI AUDIO** or **Digital MULTI AUDIO**.

2

(Except for LDs with analog audio only)

When using multi audio karaoke discs with digital audio:

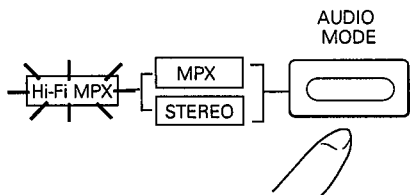

Press AUDIO MODE so that the Hi-Fi MPX indicator lights.

- Set the BALANCE control to the MUSIC side.

When using sound multiplexed CD karaoke discs:

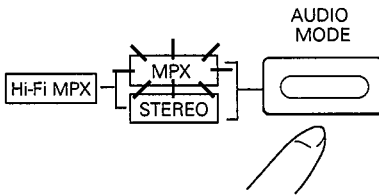

Press AUDIO MODE so that the MPX indicator lights.

- Set the BALANCE control to the MUSIC side.

When using general CDs, CDVs or LDs (with vocal) as karaoke discs:

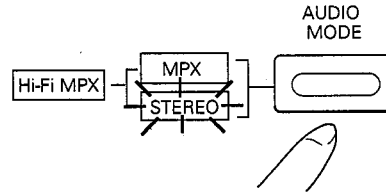

Press AUDIO MODE so that the STEREO indicator lights. The BALANCE control does not function in this mode.

To stop karaoke play:

1. Press OPEN/CLOSE.
2. Remove the disc.
 - Always be sure to remove the disc from the player when you are finished. Place the disc back in its jacket or case and store the disc in a vertical position.
3. Press OPEN/CLOSE to close the disc table.
 - Always be sure to close the disc table after you remove or load a disc.
4. When the DISC indicator stops blinking, press POWER to turn off the power.
5. Turn off and unplug the microphone(s).
 - When using a microphone equipped with a control-use miniplug, first unplug the miniplug and then unplug the main plug.

Displays in KARAOKE mode

Lights - Flashes	Function
Karaoke	Karaoke mode
Hi-Fi MPX	Hi-Fi multiplexed
MPX	Multiplexed
ONCE MORE	Once more mode

Display except for KARAOKE mode

Lights - Flashes	Function
Normal	Normal mode

CONVENIENT FUNCTIONS FOR KARAOKE PLAY - "MOOD UP" FUNCTIONS

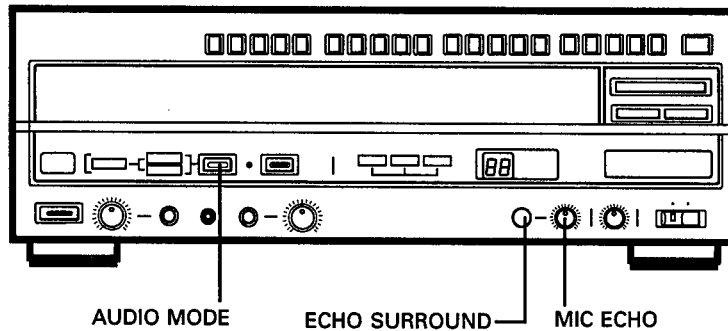

To adjust the microphone echo level

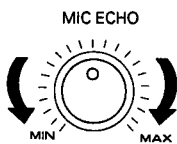

Echo is increased by turning the control to the right and decreased by turning the control to the left.

To reproduce a stage-like atmosphere

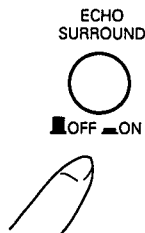

This function gives the background music a feeling of depth. Press ECHO SURROUND again to return to the original sound.

NOTE:

You can use this function only if you are using a stereo amplifier or stereo-type AV television.

To convert sound multiplexed karaoke to digital stereo sound

- Use discs which bear the or mark and have the following specifications:
 Digital audio: Stereo
 Analog audio: Multiplexed

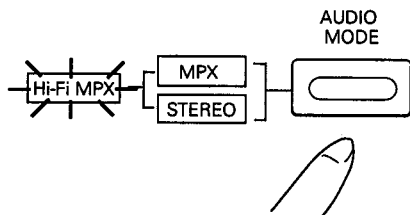

Press AUDIO MODE so that the Hi-Fi MPX indicator lights.

- The audio is converted from monaural to digital stereo.
- Hi-Fi MPX functions only in karaoke mode.

NOTE:

The effect of this function is decreased if you are not using a stereo amplifier or stereo-type AV television. Also, undulating sound may be heard with some discs; however, this is not a malfunction.

CONVENIENT FUNCTIONS FOR KARAOKE PLAY - FOR PRACTICING

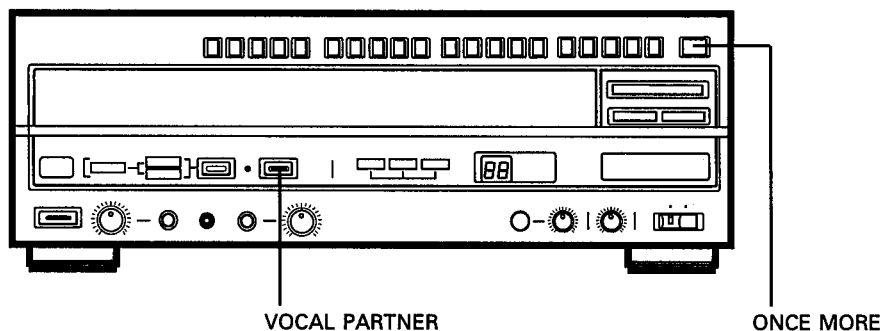

To use the "Vocal Partner" function so that the original vocals are replaced with your voice when you sing



For Example:

The Vocal Partner function can be carried out with multiplexed karaoke disc only.

With duets, you can sing only the male (female) part and let the original vocals sing the female (male) part. This is convenient for practicing only the male (female) part.

To repeat a section to correct a singing mistake



Each time ONCE MORE is pressed, playback returns to a point approximately 5 seconds earlier in the song.

If you press ONCE MORE several times, playback will return to a point earlier in the song equivalent to the number of presses x 5 seconds. However, the position will not return to a point earlier than the beginning of the selected song.

- If you press ONCE MORE while the player is in pause mode, playback will resume. (Once more start function)
- If you use a microphone equipped with a ONCE MORE button, you can carry out the Once more and Once more start functions from the microphone.

Automatic discrimination of disc type when playing various types of discs:

- CD, CDV
You can use the AUDIO MODE button to select either stereo or multiplex.
- LD (analog audio discs)
The player automatically determines whether the disc is multiplex or stereo.
- LDD (discs which contain both digital and analog audio)

Discs which bear the mark:

Multiplex has priority. The AUDIO MODE button can be used to switch the audio only with discs in which the digital and analog audio parts are different.

Discs without the mark:

The analog audio part is automatically identified. However, discrimination between stereo and multiplex for the digital audio part is not possible; the digital audio part is regarded as stereo and the AUDIO MODE button functions only with discs in which the analog audio part is multiplex.

DISPLAY SWITCHING

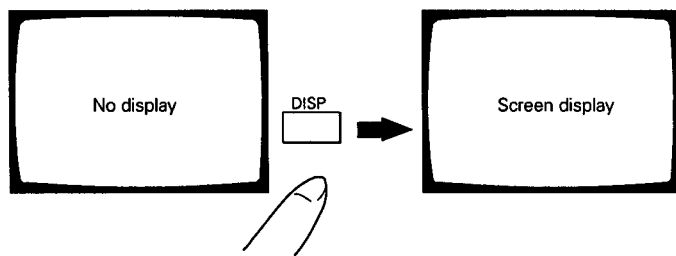

Information regarding the operations being carried out can be displayed on the screen of the monitor TV. When DISP on the remote control unit is pressed the first time, the screen is displayed.

With LD discs containing a TOC and video part of CDV discs ...

Each time DISP is pressed, the display changes in the following order: time/frame number (elapsed play time/frame from the beginning of the disc) → Remain Time ALL (remaining play time of the disc) → Total Time (total play time of the disc) → display off.

- With CAV discs, the Disc time ABS (elapsed play time from the beginning of the disc) is displayed after the frame number.

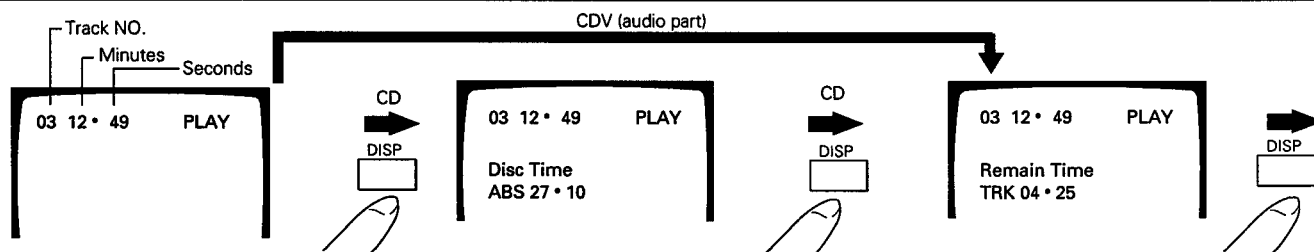
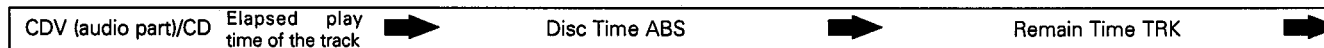
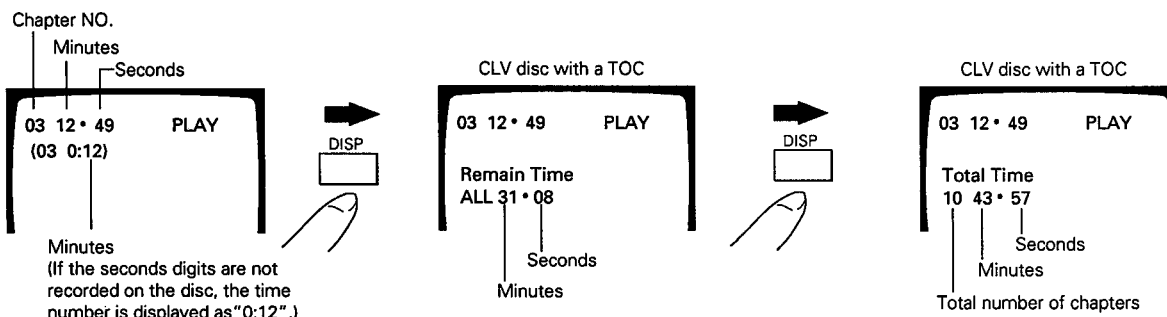
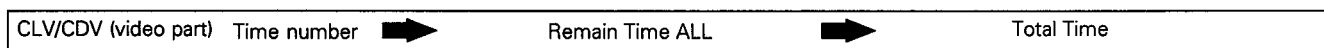

Other displays

Lights - Flashes	Function	Lights - Flashes	Function
OPEN	Opening of the table	Repeat Program	Program repeat
CLOSE	Closing of the table	Program	Program mode
STOP	Stop mode	Step-	Chapter/Track program step
PLAY	Play mode	Digital	Digital signal setting
PAUSE	Pause mode	Analog	Analog signal setting
STILL	Frozen picture	Stereo	Stereo
1/2, 1/4...	Slow-speed play	Lch	Main audio/Left channel
x2, x3	High-speed play	Rch	Sub audio/Right channel
CLV	CLV play	CX ON	CX noise reduction system ON
Video	Video part search	CX OFF	CX noise reduction system OFF
Audio	Audio part search	TV	TV broadcast
Repeat	Repeat mode	LDP	Disc playback
A-	Memory repeat	Search	Search
A-B	A-B repeat	Frame	Frame number input and search
Side -A (B)	One side repeat	Time	Time number input and search
Chapter (Track)	Chapter/track repeat		
	Chapter/track number input and search		

With LD discs having no TOC...

Each time DISP is pressed, the display changes in the following order: time/frame number → display off.

With CD discs and audio part of CDV discs...

Each time DISP is pressed, the display changes in the following order: elapsed play time of the track being played → Disc Time ABS (elapsed play time from the beginning of the disc) → Remain Time TRK (remaining play time of the track being played) → Remain Time ALL (remaining play time of the disc) → Total Time (total play time from the beginning to the end of the disc) → display off.

- With audio part of CDV discs, Disc Time ABS is not displayed.

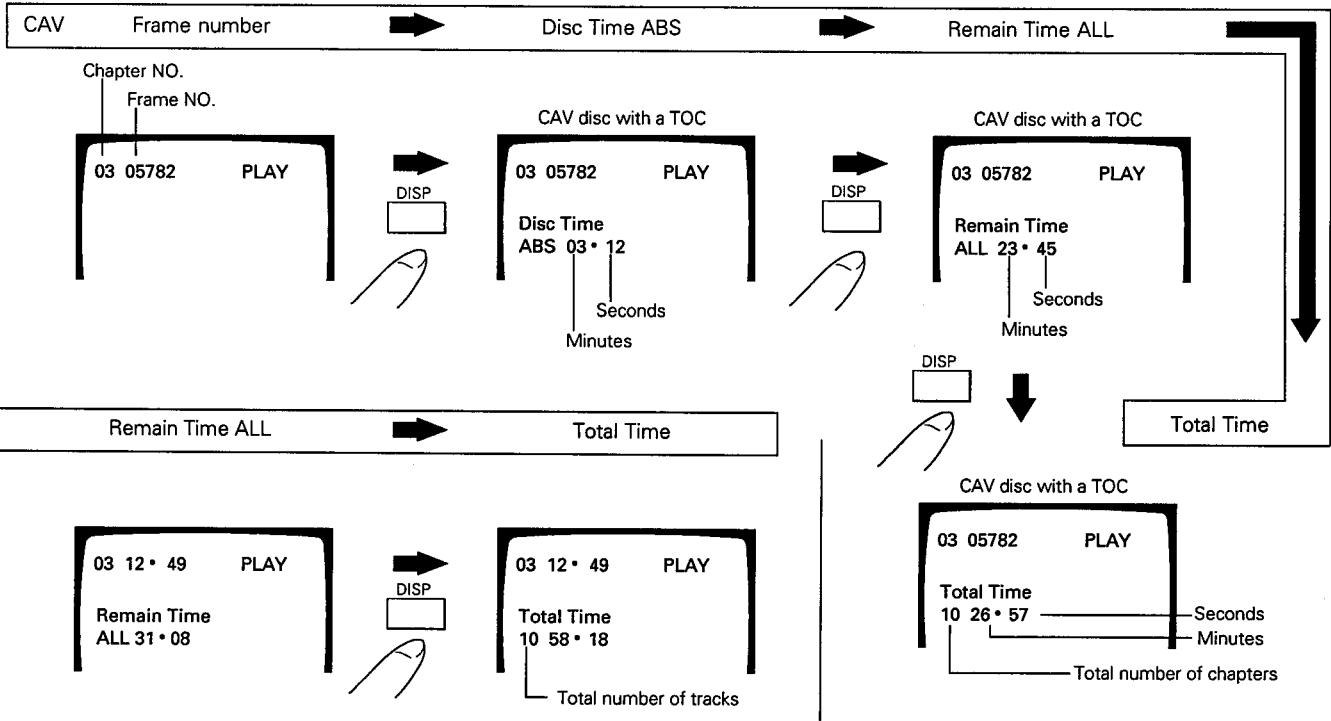

Music calendar display

On the monitor screen, you can see all of the chapter/track numbers recorded on the disc at a glance. If the disc contains more than 24 chapters/tracks, the music calendar shows the 25th and the followings after the 24th chapter/track is finished playing. The chapter/track numbers to be played are displayed in reverse color while the chapter/track numbers which have been played are displayed in normal color.

To display the music calendar

Press DISP on the remote control unit when the TOC data has been read. (After a disc is loaded, the player reads the TOC data.) With CDs or CDVs (audio part), the music calendar is immediately displayed.

With LDs (with TOC) or CDVs (video part) the music calendar is displayed during pause mode or search mode.

- Even if an LD contains chapter No. 0, the music calendar cannot display No. 0.
- With LDs without TOC, the music calendar cannot be displayed.
- The music calendar shows all of the chapter/track numbers recorded on the disc, however the TOC data (time data) of the 37th or more cannot be memorized.

Audio output level meter display:

During elapsed play time of the track mode of CD playback or CDV (audio part) playback, the audio output level meter will be displayed on the monitor screen.

NOTE:

In some cases, the displayed output level may differ from the actual output level, but this is not a malfunction.

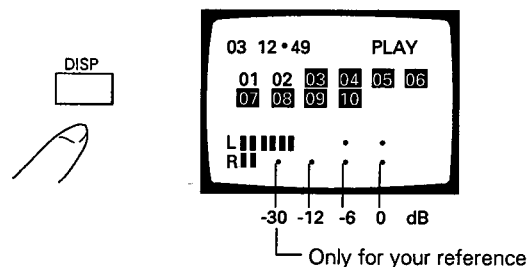

Only for your reference

TO PLAY AN LD, CDV OR CD

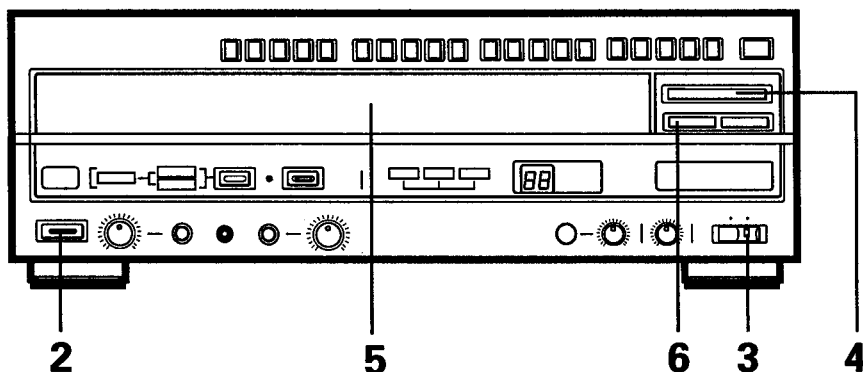

1

Turn on the power to the monitor TV and/or audio system.

Set the TV to the video-use channel (the vacant channel in your area) or select the appropriate video signal input. (See pages 13 and 15.)

When a stereo system is used for audio listening:

Turn on the power of the amplifier, and set its input selector to the proper position for listening to the PLAYER, such as "CD".

2

Turn on the power to this unit.

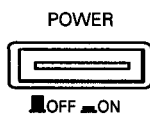

3

Set KARAOKE/NORMAL to NORMAL.

KARAOKE • • NORMAL

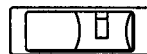

4

Open the disc table.

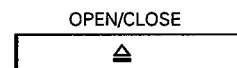

Front panel

or



Remote control unit

State of the display window during playback:

LD



Chapter number

CD/CDV



Track number

If the picture is not clear:

Confirm that the CHANNEL SELECTOR switch on the rear panel of the player is set to the same channel as the TV channel used for disc playback.

1. Set your TV set to the channel (3 or 4) used for disc playback.
2. Start disc playback.
3. Adjust your TV set so that a clear picture is obtained.

* If stripes or noise appears on the screen, place the VHF antenna cable further away from this unit's power cord.

Front panel buttons and remote control unit keys with the same name or mark have the same function.

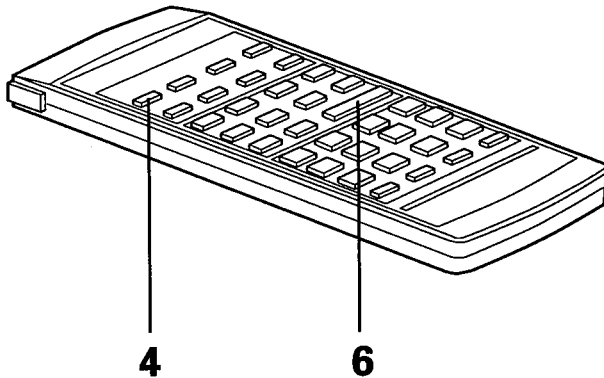

5

Load a disc

As shown in the following diagram, place the disc on the disc table in the groove corresponding to the size of the disc.
 If the disc is not centered correctly on the disc table, the disc will not be played or the disc or the player may be damaged.
 Always place the disc correctly according to the required disc size on the disc table.

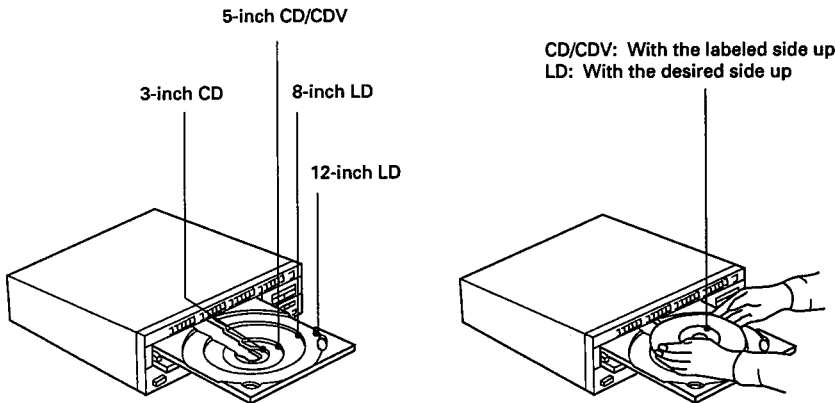

6

Start playback.



Front panel

or



Remote control unit

- With CDV discs, the video part is played first.

To avoid malfunctions, be especially careful about the following points.

- Do not place any object other than a disc on the disc table.
- Do not move the player while a disc is playing. This will cause the disc to be scratched.
- Be careful not to catch your finger in the disc table section while the disc table is being retracted into the unit. Also, be careful that children do not put their hands into the inside of the unit while the disc table is open. This may cause injury.

Precautions concerning disc loading

- Do not place more than one disc on the disc table. If two discs are placed one on top of the other on the disc table, discs may be scratched and/or malfunction may occur.
- With this unit, playback of all types of CD Video discs is carried out without the use of adapters. Therefore, do not use any type of adapter with this unit.

TO PLAY AN LD, CDV OR CD (Continue)

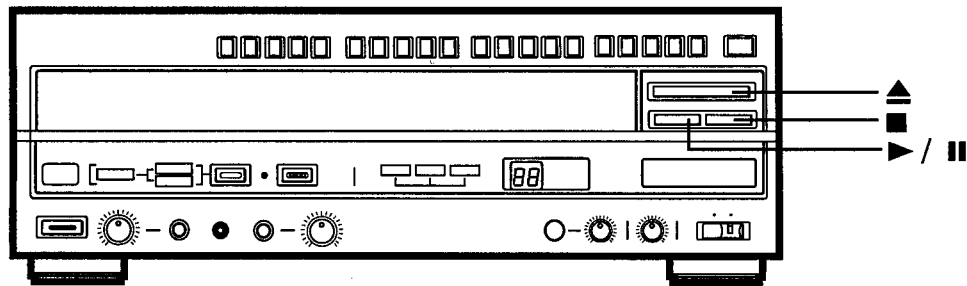

To pause playback temporarily

PLAY/PAUSE

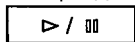

or

PAUSE



The sound and/or video image disappears. Press PLAY/PAUSE ▶/|| or PAUSE || again to resume playback from the position where pause mode was entered.



To stop playback

STOP



or

EJECT

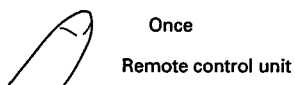

When PLAY/PAUSE ▶/|| or PLAY ▶ is next pressed, disc playback starts again from the beginning.



To stop playback and take out the disc

OPEN/CLOSE

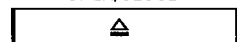

or

EJECT

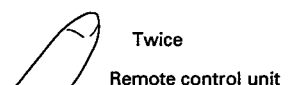

After removing the disc from the disc table, press OPEN/CLOSE, PLAY/PAUSE ▶/|| or PLAY ▶ to close the table.

Discs marked with the mark

Discs marked  are recorded with the CX noise reduction system for powerful audio reproduction with little noise.

However, some discs marked are not encoded with the signals necessary to instruct the unit to automatically switch on the CX system. If sound is noisy or undulate when a disc with a  mark is played, press CX key on the remote control unit.

-  is a trademark of CBS inc. This player meets the CX EXPANDING SPECIFICATION.

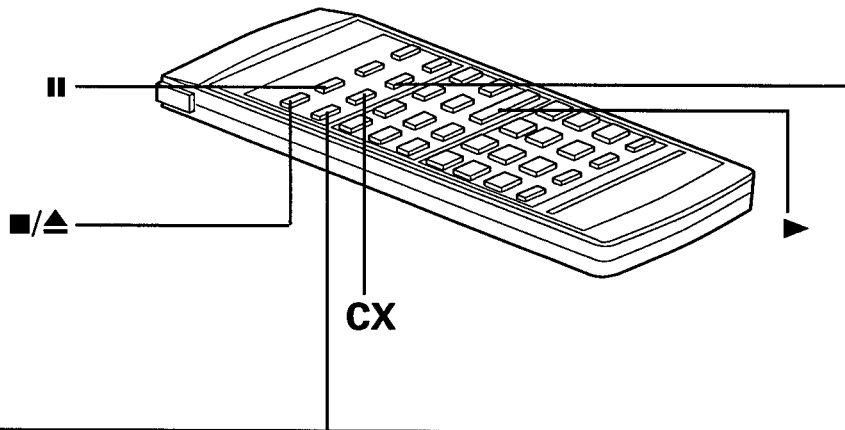

To listen to only one channel of a stereo disc, or to select the audio on a sound multiplexed disc:

During playback

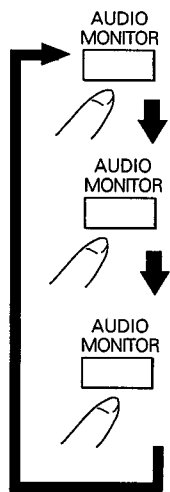

Played audio		Display on screen
Stereo disc	Sound multiplexed disc	
Stereo	Audio 1/L (Left) Audio 2/R (Right)	
Left	Audio 1/L (Left)	L ch
Right	Audio 2/R (Right)	R ch
Return to start		Stereo

- Be sure to set KARAOKE/NORMAL to NORMAL. Otherwise, AUDIO MONITOR cannot be operated.

To listen to the analog audio of an LD digital audio disc:

During playback

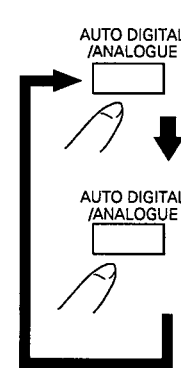

Played audio	Display on screen
Digital	
Analog	Analog
Return to start	Digital

With a Multi Audio disc having digital sound, you can listen to the various audio tracks recorded on the disc by using AUTO DIGITAL/ANALOGUE to select between the analog and digital audio tracks, and by using AUDIO MONITOR to select between the left (1/L) and right (2/R) channels.

Examples of the various types of audio recorded on Multi Audio discs

Disc	Audio	Analog audio	Digital audio
Movies, animations, etc.		Audio of the main program	Soundtrack
Dual music		Music 1	Music 2
Various types of digital audio karaoke		1/L Karaoke (monaural) 2/R Assisting vocals	Stereo karaoke
Stereo bilingual		Native language	Foreign language 1

Disc	Audio	Analog audio	Digital audio
Trilingual		Native language	1/L Foreign language 1 2/R Foreign language 2
Quadlingual		1/L Native language 2/R Foreign language 1	1/L Foreign language 2 2/R Foreign language 3

TO SEARCH FOR A PARTICULAR PASSAGE

Search using fast forward or fast reverse – Manual Search

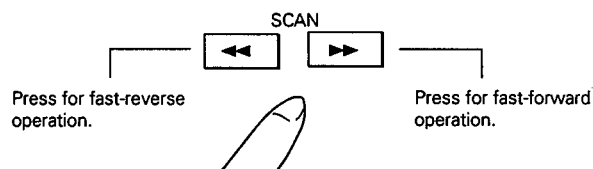

For about two seconds after the key is pressed, the scan speed is fairly slow, after that, it changes to high speed. With the video part of CDV, the scan speed does not change to high speed.

Normal playback resumes as soon as the button is released. When fast-forward playback reaches the end of the disc, the player enters pause mode with CLV discs, while a still frame is displayed with CAV discs. (When fast-forward playback reaches the end of the video part of a CDV disc, the unit enters pause mode.)

When fast-forward playback reaches the end of the CD disc or audio part of CDV disc, the unit enters pause mode. When fast-reverse playback reaches the beginning of the disc, normal playback resumes.

During Manual Search operation

LD/CDV(video part): Sound is muted.

CD/CDV(audio part): Sound is heard at a small volume level.

Notes on CLV (extended play) discs

- When a CLV disc is scanned, the colors may fade and the picture may become distorted.
- The scanning speed of a CLV disc varies depending on the radial distance of the laser pickup from the center of the disc.

Remain Time display

With LD discs containing TOC, Remain Time cannot be displayed during Manual Search.

TO SEARCH FOR A PARTICULAR CHAPTER/TRACK

Chapter (Track) Search/Chapter (Track) Skip

The term "chapter" refers to each section on an LD, and the term "track" refers to each section on a CD or CDV disc.

If chapter or track numbers are encoded on a disc, it is so indicated on the disc jacket.

- Chapter Search is not possible with discs which are not divided into chapters.
- If chapter (track) number beyond the last chapter (track) number on the disc is specified, Chapter (Track) Search cannot be carried out.

Chapter (Track) Search – To search by designating the chapter/track number

Example:

To play from the beginning of Chapter/Track 3:

<Direct Search>

3

Enter 3 with the digit key.



<Normal Search for LD only>

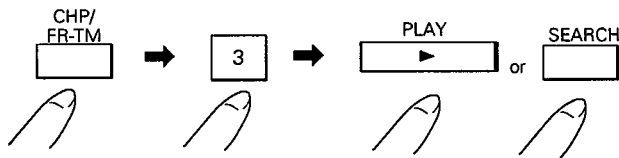

When the display shows Frame No. or Time No. press this key again.

Enter 3 with the digit key

To search for chapter or track number 10 or above:

Use [+10] key.

(Example) To enter 17: [+10], [7]

To enter 30: [+10], [+10], [+10], [0]

If you make a mistake in pressing the digit keys:

Press CLEAR, and then press the correct key.

To identify the present chapter number and frame (or time) number:

The information can be displayed on the monitor TV screen by pressing DISP on the remote control unit.

The difference between the PLAY ► function and SEARCH function for Normal Search:

With CAV discs, if SEARCH is pressed, the beginning of the designated chapter is played with still frame. If PLAY ► is pressed, Normal playback starts from the beginning of the designated chapter.

Chapter (Track) Skip – To search for the beginning of a chapter/track



Press once to return the playback position to the beginning of the chapter/track being played. If the key is pressed more than once before the picture reappears, the beginning of a chapter/track located before the chapter/track being played is searched for and played. The position of the located track corresponds to the number of times the key is pressed.

If this key is pressed once or a number of times, playback is advanced to the beginning of a chapter/track located after the chapter/track being played. The position of the located track corresponds to the number of times the key is pressed.

To cancel the search operation

Press CLEAR while the player is searching for the chapter or track.

TO SEARCH FOR A PARTICULAR TIME/FRAME

Time Number Search/Track time Search/ABS Time Search/Frame Number Search

Time Number Search (CLV/video part of CDV) – Example: To search for the scene located at time number 12 min. 34 sec

1. **Press CHP/FR-TM/TRACK/TIME.**
When the display shows chapter No., press this key again.
2. **Enter 1, 2, 3 and 4 with the digit keys.**
If you make a mistake during entry:
Press CLEAR to reset the time number to "00•00", and press the correct digit keys again.
3. **Press SEARCH or PLAY ►.**

CAUTION

- If a disc does not contain information on the digits of seconds, specify the time number only as far as the minute digits.
- The +10 key does not function to specify the time number.
- If time number beyond the last time number on the disc is specified, the unit enters stop mode.

Track Time Search (CD/audio part of CDV) – To search for a time on a specified track

1. **Press CHP/FR-TM/TRACK/TIME.**
2. **Press CHAPTER SKIP/TRACK SEARCH ◀◀ or ▶▶ so that the desired track number appears in the front panel track display window.**

3. **Enter the track time (elapsed time from the beginning of the specified track) with the digit keys (0 - 9).**
 - The +10 key does not function.
 - If you make a mistake during entry, press CLEAR and press the correct digit keys.
 - When the specified track time exceeds the recorded track time, playback starts from the beginning of the next track.

4. **Press SEARCH or PLAY ►.**

ABS Time Search (CD only) – To search for a point by designating the elapsed time from the beginning of the disc

- 1 **Press CHP/FR-TM/TRACK/TIME so that "ABS" appears on the monitor screen.**
- 2 **Enter the elapsed time from the beginning of the disc with the digit keys (0-9).**
 - The +10 key does not function.
 - If you make a mistake during entry, press CLEAR and press the correct digit keys.

- 3 **Press PLAY ► or SEARCH.**
Playback starts from the specified elapsed time.

Frame Number Search (CAV discs only) – To search by designating the frame number

Any desired frame can be searched for by specifying its frame number.

1. **Press CHP/FR-TM/TRACK/TIME. When the display shows chapter NO., press this key again. "Frame 00000" is displayed.**
2. **Enter the required frame number with the digit keys (0 - 9).**
 - The +10 key does not function.
 - If you make a mistake during entry, press CLEAR and press the correct digit keys.
3. **Press SEARCH or PLAY ►.**

When SEARCH is pressed:

A still frame is displayed. For normal playback, press PLAY ►.

CAUTION

If frame number beyond the last frame number on the disc is specified, the end of the disc is played with still frame. (If "00000" is specified, playback starts from the beginning of the disc.)

To exit search mode:
Press CLEAR.

- If time/frame number beyond the last time/frame number on the disc is specified, Time/Frame Number Search cannot be carried out.

EXTRA PLAYBACK (CAV LD only)

Still frame and Frame-by-Frame advance function

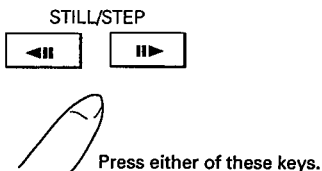

During playback if STILL/STEP is pressed, the picture will be frozen. At this point, the disc can be played one frame at a time in either the forward or reverse direction by pressing one of these keys. Holding the key pressed advances frames continuously. The sound is muted during still frame or frame advance operation. To return to normal operation, press PLAY ►.

To vary the playback direction or speed

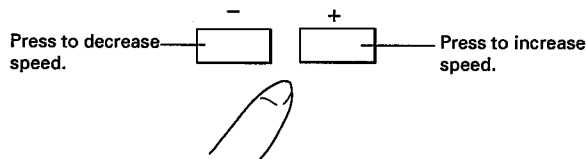
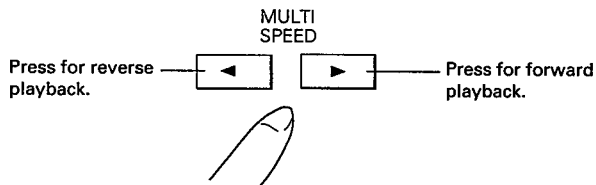

During playback, the playback direction can be changed with MULTI SPEED. 1/4 the normal playback speed is set first automatically.

With + and - keys, the playback speed can be changed from x 3 to 1/90 the normal playback speed.

Sound is muted during Multi-speed playback operation. To return to normal playback operation, press PLAY ►.

- The selected speed is displayed by pressing DISP on the remote control unit.

Speed display	Speed
x3	3 times the normal playback speed.
x2	Twice the normal playback speed.
x1	Normal playback speed.
1/2	1/2 the normal playback speed.
1/4	1/4 the normal playback speed.
1/8	1/8 the normal playback speed.
1/16	1/16 the normal playback speed.
1/30	1/30 the normal playback speed.
1/90	1/90 the normal playback speed.

Faster
↑
↓
Slower

No sound?

During Multi-speed playback, sound is not heard.

Disc Time ABS display and Remain Time ALL display:

With CAV discs, Disc Time ABS and Remain Time ALL cannot be displayed during reverse playback which is played at x1, x2, x3 speed and forward playback which is played at x2, x3 speed.

If playback automatically switches to still frame display mode.

If a disc containing special signals called "picture stop codes" is played at x1, x1/2, x1/4, x1/8, x1/16, x1/30, or x1/90 speed, playback pauses automatically whenever the unit encounters a frame where a picture stop code is encoded, and the still picture of that frame is displayed on the monitor screen. To move from that position, press Play ►, MULTI SPEED ◀▶, ◀◀▶▶ or ◀◀▶▶▶▶.

TO REPEATEDLY PLAY A DESIRED PASSAGE – Repeat Playback

Memory Repeat – To specify a point to return to later

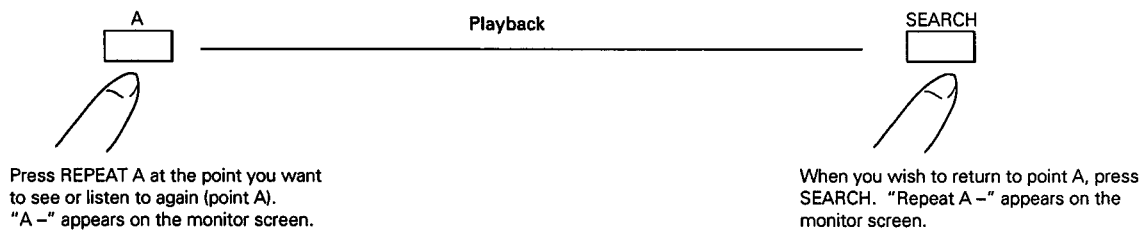

A-B Repeat – To repeat a specified section

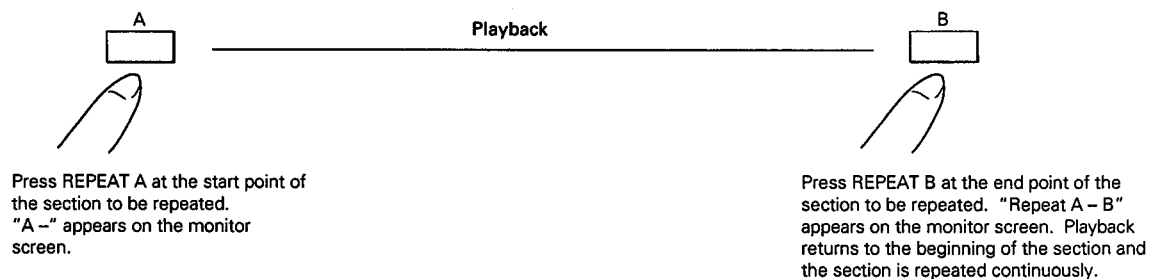

Chapter/Track Repeat – To repeat the current chapter or track

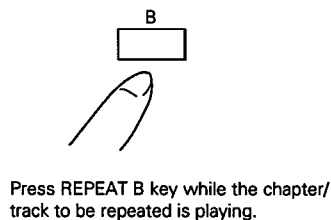

When the end of the chapter/track is reached, the player returns to the beginning of the chapter/track and the chapter/track is played back repeatedly.

When the player returns to the beginning of the chapter/track, "Repeat Chapter/Track" appears on the monitor screen.

To exit repeat mode:

Press CLEAR. Repeat mode is canceled and normal playback continues from the current point.

To specify a different point in Memory Repeat mode:

Press REPEAT A at the new point. The previously memorized point is erased and replaced with the new point.

Memory Repeat and A-B Repeat with CDV discs:

These repeat functions can only be carried out within the video part or within the audio part, and cannot be carried out between the two parts.

With LDs which have no chapter numbers:

Chapter repeat cannot be carried out.

To display repeat mode on the monitor screen:

Press DISP on the remote control unit.

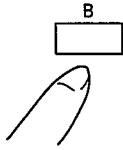
One Side Repeat – To repeat an entire side of a disc

Press REPEAT B twice.
"Repeat Side – A" appears on the monitor screen.

When playback reaches the end of the playback side, the player returns to the beginning of the disc and the same side is played back repeatedly.
With CDV discs, when playback reaches the end of the audio part, the player returns to the beginning of the video part and the whole disc is played back repeatedly.

Program Repeat – To repeat a program

With the program repeat function, you can repeatedly play programmed chapters or tracks in their programmed order.

- See page 38 for details on programming.

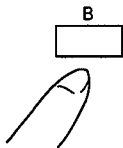

Press REPEAT B while the program is being played. "Repeat Program" appears on the monitor screen.

TO PLAY ONLY THE DESIRED CHAPTERS/TRACKS – Program Playback

Selected chapters (LD) or tracks (CDV/CD) can be played in any desired order (max. 24 chapters or tracks).

- You can view the state of programming on the monitor TV screen.

Example To play CD tracks No. 9, No. 7, and No. 18 in this order:

1 Press PGM.

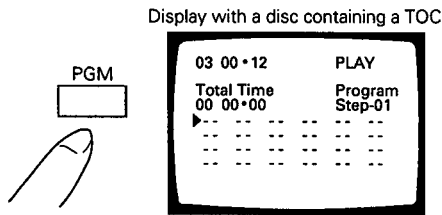

2 Enter 9, 7, +10, and 8 with the digit keys.

If you make a mistake during entry: Press CLEAR and enter the correct number with the digit keys.

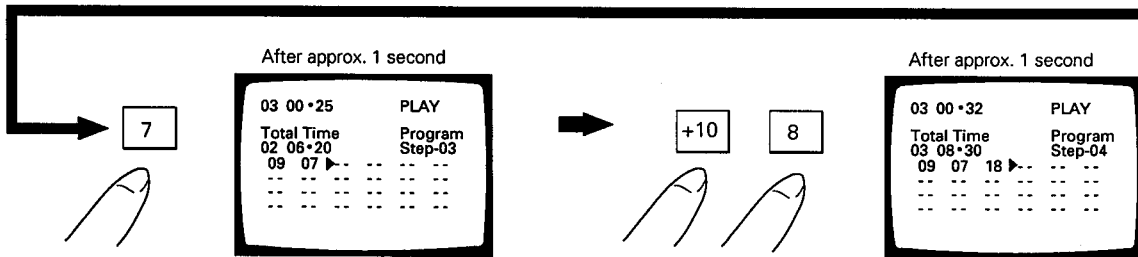
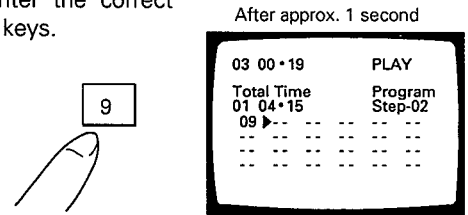

3 Press PLAY ▶.

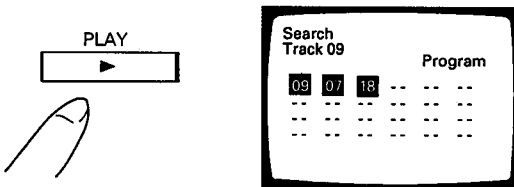

The first track (chapter) in the program is searched for and played. In this example, Program Playback starts at the beginning of track number 9.

After tracks No. 9, No. 7, and No. 18 have been played, the player enters stop mode.

To stop program play in the middle:

- Press STOP ■ on the front panel of the player or EJECT ■/▲ on the remote control unit, or
- Press CLEAR.

To clear the program contents:

- Open the disc table, or
- Press CLEAR in stop mode.

Programming a pause:

When recording on a cassette tape, a programmed pause allows you to change the tape side or to record a blank section on the tape which is useful for music search functions, etc.

When a program is in pause mode, pressing PAUSE ■ resumes disc playback, so restart recording before pressing PAUSE ■.

To program a pause:

In step 2 of the above procedure, press PAUSE ■ instead of entering a chapter or track number.

NOTE:

- A pause cannot be programmed for step 1 (01), and it cannot be programmed for two consecutive steps.
- A pause can be programmed for the last program step, however, it will not be effective.

Programmed pause indication:

"■" is displayed on the monitor screen.

To go to the previous or next chapter (track) in a program:

Press CHAPTER SKIP/TRACK SEARCH ◀◀ or ▶▶.

Total time display (CD and CDV only):

When programming for CD or CDV, the total time of the programmed tracks is displayed. If the total time exceeds 100 minutes, 100's digit will be displayed.

To check the program contents

During program playback or in stop mode, press PGM to display the program contents on the monitor screen. When PGM is pressed again, the program contents disappear.

To modify the program contents

To erase a programmed chapter/track or pause

- 1 Press PGM.
- 2 Press PGM CORRECT ◀◀ or ▶▶ to place the cursor (▶) on the left side of the chapter/track or pause to be erased.
- 3 Press CLEAR.
- 4 Press PGM to complete programming. Pressing PLAY also completes programming and starts program playback with the new program contents.

To change a programmed chapter/track or pause to a new one

- 1 Press PGM.
- 2 Press PGM CORRECT ◀◀ or ▶▶ to place the cursor (▶) on the left side of the chapter/track or pause to be changed.
- 3 Enter the new chapter/track number with the digit keys. Press PAUSE ■■ to enter a pause.
- 4 Press PGM to complete programming. Pressing PLAY also completes programming and starts program playback with the new program contents.
 - Programmed chapter/track being played cannot be erased or changed.
 - During pause mode, a pause cannot be erased or changed.

CAUTION

- If MUSIC SELECTOR on the front panel is used, programming may not be correctly performed. Use the digit keys on the remote control unit for programming.
- If SCAN ▶▶ is held depressed during Program Playback, the playback position will move to another chapter/track, but when ▶▶ is released, the next chapter/track in the program will be played. If ◀◀ is held depressed, the playback position returns to the beginning of the current chapter or track being played, but it will not go beyond it to a previous chapter or track in the program.
- If MULTI SPEED ▶ is pressed during Program Playback, the next track in the program will be played with Multi speed. If MULTI SPEED ◀ is pressed, the playback position returns to the beginning of the current chapter being played, and the player enters normal play mode.

TROUBLESHOOTING



Incorrect operations are often for trouble and malfunctions. If you think that there is something wrong with this component, check the points below. Sometimes the trouble may lie in another component. Inspect the other components and electrical appliances being used. If the trouble cannot be rectified even after exercising the checks listed below, ask your nearest PIONEER authorized service center or your dealer to carry out repair work.

SYMPTOM	CAUSE	REMEDY
1. Disc table is not ejected when OPEN/CLOSE is pressed.	<ul style="list-style-type: none"> ● Power cord is not properly plugged into AC wall socket. ● Power switch is not turned on. 	<ul style="list-style-type: none"> ● Plug in power cord. ● Turn on power switch.
2. Disc table comes out.	<ul style="list-style-type: none"> ● Disc is dirty. ● The disc is not properly set on the disc table. ● Moisture has condensed on parts in the player. ● Disc is warped. 	<ul style="list-style-type: none"> ● Clean disc. ● Set the disc properly. ● Remove disc and let player stand for 1 to 2 hours until it is dry. ● Try to alleviate the warp. (Refer to Symptom 17, remedy column.)
3. TV no longer receives other channels after it has been connected to the player.	<ul style="list-style-type: none"> ● Antenna cable has not been connected. ● LDP mode is selected. 	<ul style="list-style-type: none"> ● Connect VHF antenna cable to antenna terminal on the player. ● Select the TV mode by pressing TV/LD or turning off the player's POWER.
4. Slanting stripes appear on the TV screen when TV/LD is pressed to receive TV broadcasts.	<ul style="list-style-type: none"> ● Electric field for TV broadcasting is weak. (This does not indicate any trouble.) 	<ul style="list-style-type: none"> ● Turn off POWER of the player. We recommend that you turn off POWER of the player, whenever you intend to watch TV for a long time.
5. Remote control does not work.	<ul style="list-style-type: none"> ● The CONTROL IN terminal on the rear panel is connected to pioneer projection monitor or AV control center. ● Batteries are weak. ● There is an obstacle between the player and the remote control unit. ● Remote control unit is not in a good location for transmission. 	<ul style="list-style-type: none"> ● Aim the remote control unit at the projection monitor or AV control center. ● Replace batteries. ● Remove the obstacle or shift the remote control position. ● Operate the remote control unit in front of the player.
6. Operation of the remote control unit causes the TV to operate improperly.	<ul style="list-style-type: none"> ● Some TV sets have remote control functions that operate improperly in response to the remote control unit of the player. 	<ul style="list-style-type: none"> ● Move the TV and the player further apart, or cover the remote sensor of the TV during disc playback.

TROUBLESHOOTING

WHEN PLAYING KARAOKE

For karaoke play, always set the KARAOKE/NORMAL selector to the KARAOKE position.

SYMPTOM	CAUSE	REMEDY
7. The One-Song Pause function or other KARAOKE functions cannot be operated.	<ul style="list-style-type: none"> ● The KARAOKE/NORMAL selector is set to the NORMAL position. 	<ul style="list-style-type: none"> ● Set it to the KARAOKE position.
8. The BALANCE control does not function.	<ul style="list-style-type: none"> ● The KARAOKE/NORMAL selector is set to the NORMAL position. ● The AUDIO MODE button is set to the STEREO position when playing a sound multiplexed CD or CDV karaoke disc. 	<ul style="list-style-type: none"> ● Set it to the KARAOKE position. ● Set the AUDIO MODE button so that the STEREO indicator goes out.
9. Hi-Fi stereo multiplexed sound is not possible.	<ul style="list-style-type: none"> ● The KARAOKE/NORMAL selector is set to the NORMAL position. ● The Hi-Fi stereo multiplexed sound disc is not used. 	<ul style="list-style-type: none"> ● Set it to the KARAOKE position. ● Use a karaoke disc which bears  MULTI AUDIO or  MULTI AUDIO.
10. The original vocals are not replaced with the singing voice even when VOCAL PARTNER is pressed.	<ul style="list-style-type: none"> ● Multiplexed karaoke disc is not used. ● The volume level of the microphone is too low. ● The singing voice level is too small. ● The AUDIO MODE button is not set to the appropriate audio mode with a CD or auxiliary device. 	<ul style="list-style-type: none"> ● Use Multiplexed karaoke disc. ● Raise the volume level. ● Sing louder. ● Set it to the appropriate mode.
11. The Once more operation cannot be carried out with the Pioneer Microphone DM-V161.	<ul style="list-style-type: none"> ● The microphone control jack ( MC) is not connected. ● The microphone is not turned on. 	<ul style="list-style-type: none"> ● Connect it. ● Turn on the microphone.
12. Some songs cannot be selected with MUSIC SELECTORS.	<ul style="list-style-type: none"> ● The selected number does not exist on the disc. 	<ul style="list-style-type: none"> ● Select the song which exists on the disc.
13. The next song starts playback after one song is finished.	<ul style="list-style-type: none"> ● When playback is started with PLAY/PAUSE (or PLAY) or resumed with PLAY/PAUSE (or PAUSE), the player is always in playback mode even when one song is finished. 	<ul style="list-style-type: none"> ● Select the song with MUSIC SELECTOR.
14. The original vocals cannot be heard with a sound multiplexed Laser Karaoke disc.	<ul style="list-style-type: none"> ● The BALANCE control is set to the MUSIC side. 	<ul style="list-style-type: none"> ● Set it to the VOCAL side.

TROUBLESHOOTING

WHEN A LASERVISION DISC IS BEING PLAYED

SYMPTOM	CAUSE	REMEDY
15. Disc is rotating but there is no picture.	<ul style="list-style-type: none"> ● The TV set is not turned on. ● Wrong connections from player to TV. ● TV set is not tuned to channel 3 or 4. ● Player CHANNEL SELECTOR is at the wrong setting. ● The television is not properly tuned. ● TV mode is selected. 	<ul style="list-style-type: none"> ● Turn on TV. ● Make correct connections. ● Set TV to the channel (3 or 4) that is not used for TV broadcasting in your area. ● Set selector to same channel as the TV's vacant channel. ● Tune the television properly. (Refer to the User's Manual for the television.) ● Select the LDP mode by pressing TV/LD.
16. Picture continuously moves vertically.	<ul style="list-style-type: none"> ● The TV vertical hold control is not adjusted properly. 	<ul style="list-style-type: none"> ● Adjust vertical-hold control on TV.
17. Particular disc does not playback properly. The playback stops in the middle of the disc program.	<ul style="list-style-type: none"> ● The playing surface of the disc is dirty. ● The disc is warped. 	<ul style="list-style-type: none"> ● Use a soft cloth and lightly wipe off the dirt from the surface of the disc. If necessary, moisten a cloth with diluted neutral detergent to remove heavy dirt or fingerprints. ● LD discs only Put the disc into the protective envelope, then place it on a flat desk top. Subsequently, place a flat board e.g. glass plate on the disc, and load it with about 4 ~ 5 kgs (about 10 lbs). If it is left in this state for one day, sometimes the warp will alleviate. <div style="text-align: center; margin-top: 10px;"> <p style="text-align: center;">Heavy books about 4 ~ 5 Kgs (10 lbs)</p> <p style="text-align: center;">LD disc Glass plate Glass plate Protective envelope</p> </div>
18. Sound is unnatural or distorted.	<ul style="list-style-type: none"> ● CX system is turned ON for disc which has no mark. 	<ul style="list-style-type: none"> ● Press CX to turn CX system OFF.
19. No sound output during playback.	<ul style="list-style-type: none"> ● MULTI-SPEED or STILL/STEP playback is being performed. Sound is output only during the normal play mode. The audio signals are not output during other playback modes. ● The KEY CONTROL ON/OFF switch of the rear panel is set to the ON position when the player is not connected with the key controller. 	<ul style="list-style-type: none"> ● Press PLAY or PLAY/PAUSE to set the player to normal play mode. ● Set the KEY CONTROL ON/OFF switch to the OFF position.
20. During STILL playback, a part of the screen image shakes.	_____	<ul style="list-style-type: none"> ● Even if the disc is a standard play disc, there may be some cases in which a fully still image cannot be obtained, but this does not mean that the player or the disc is defective.
21. CHAPTER SKIP, CHAPTER PROGRAM PLAY and CHAPTER NUMBER SEARCH cannot be performed.	<ul style="list-style-type: none"> ● Disc in which no chapter numbers are recorded is loaded. 	<ul style="list-style-type: none"> ● Press DISP to check if chapter number is displayed.

TROUBLESHOOTING

SYMPTOM	CAUSE	REMEDY
22. Certain discs take too long to search for or do not search for.	<ul style="list-style-type: none"> It takes time to read the recorded code, depending on the disc. 	<ul style="list-style-type: none"> Press CLEAR and picture will appear. (At this point, a slightly different scene from that which has been searched for may appear.)
23. Certain discs take too long to start or do not start.	<ul style="list-style-type: none"> There are errors when the disc code is read (There is no damage to the unit). 	<ul style="list-style-type: none"> Press STOP and stop the playback. Press the PLAY or PLAY/PAUSE and start the playback again. (Repeat this operation a few times.)
24. The player takes too long to find point A during A-B (INTERVAL) REPEAT operation.	<ul style="list-style-type: none"> Same as item 22 above. 	<ul style="list-style-type: none"> Same as item 22 above. (The repeat mode is cancelled).
25. Picture other than instructed is searched in TIME NUMBER SEARCH mode.	<ul style="list-style-type: none"> Method of inputting numerals in the TIME NUMBER SEARCH mode differs, depending on whether time number is recorded on disc in hours and minutes or minutes and seconds, as shown below: [e.g.] 12-minute search Disc in which time number is recorded in hours and minutes <div style="text-align: center; margin: 10px 0;"> <p style="margin: 0;"> CHP/FR-TM 1 2 SEARCH </p> <p style="margin: 0; text-align: center;">"minutes"</p> </div> <ul style="list-style-type: none"> Disc in which time number is recorded in minutes and seconds <div style="text-align: center; margin: 10px 0;"> <p style="margin: 0;"> CHP/FR-TM 1 2 0 0 SEARCH </p> <p style="margin: 0; text-align: center;"> "minutes" "seconds" </p> </div>	

TROUBLESHOOTING

WHEN PLAYING BACK A COMPACT DISC

SYMPTOM	CAUSE	REMEDY
26. Player stops immediately after playback is started.	<ul style="list-style-type: none"> ● Disc is loaded upside down (CD, CDV, onesided LD discs). ● The playing surface of the discs is dirty. ● Disc is not properly set on the disc table. 	<ul style="list-style-type: none"> ● Load the disc correctly with the label side upward. ● Use a soft cloth and lightly wipe off the dirt from the surface of the disc. If necessary, moisten a cloth with diluted neutral detergent to remove heavy dirt or fingerprint. ● Set the disc properly.
27. No sound output	<ul style="list-style-type: none"> ● The stereo amplifier is not correctly connected. ● You are not operating the stereo amplifier correctly. ● The connection terminals and/or the plugs of the connection cords are dirty. ● The plugs of the connection cords are disconnected, or are not fully pushed in. ● The player is in pause mode. 	<ul style="list-style-type: none"> ● Connect the amplifier correctly. ● Refer to the operating instructions for the amplifier, and operate the amplifier correctly. ● Clean the plugs and terminals and connect again. ● Make sure that connections are made correctly. ● Press PLAY/PAUSE and restore the player to play mode.
28. Sound is distorted.	<ul style="list-style-type: none"> ● The audio output jacks are connected to the PHONO jacks. ● The connection terminals and/or the plugs of the connection cords are dirty. ● The plugs of the connection cords are not fully pushed in. 	<ul style="list-style-type: none"> ● Connect to the AUX, CD, VDP, LD or VCR jacks. ● Clean the plugs and terminals and connect again. ● Push the plug in firmly.

SPECIFICATIONS

1. General

System	LaserVision Disc system and Compact Disc digital audio system
Laser	Semiconductor laser wavelength 780 nm
Power requirements	AC 120V, 60 Hz
Power consumption	43W
Weight	8.3 kg (18 lbs 5 oz)
Dimensions	420 (W) x 421 (D) x 136.5 (H) mm 16-9/16 (W) x 16-9/16 (D) x 5-3/8 (H) in
Operating temperature	+5°C ~ +35°C (41°F - 95°F)
Operating humidity	5% ~ 90% (There should be no condensation of moisture.)

2. Disc

LaserVision Discs

*Maximum playing times	
12-inch standard play disc	1 hour/both sides
12-inch extended play disc	2 hours/both sides
8-inch standard play disc	28 min/both sides 14 min/one side
8-inch extended play disc	40 min/both sides 20 min/one side
Spindle motor speed	
Standard play disc	1,800 rpm
Extended play disc	1,800 rpm (inner circumference) to 600 rpm (outer circumference) (For a 12-inch disc)

Compact Discs

DISC	Diameter: 5-inch, 3-inch, Thickness: 1.2 mm
Rotation direction (pickup side)	Counterclockwise
Liner speed	1.2 ~ 1.4m/sec
*Maximum playing time	
	74 min. 5-inch discs 20 min. 3-inch discs (For stereo playback)

Compact Discs with Video

Disc	Diameter: 5-inch, Thickness: 1.2 mm
Rotation direction (pickup side)	Counterclockwise
Linear speed	Audio portion: 1.2 ~ 1.4m/sec Video portion: 11 ~ 12m/sec
*Maximum playing time	Video portion: 5 min. (CLV) Audio portion: 20 min. (Digital)

* Actual playback time differs for each disc.

3. Video characteristics

Format	NTSC specifications
Video output	
Level	1 Vp-p nominal, sync. negative, terminated
Impedance	75Ω unbalanced
Jack	RCA jack (2 systems)
VHF output	
Channel	Channel 3 or 4 (switchable)
Impedance	75Ω unbalanced
Terminal	F-type jack

4. Audio characteristics

Output level	
During analog audio output	200 mVrms (1 kHz, 40%)
During digital audio output	200 mVrms (1 kHz, -20 dB)
Jacks	Both RCA jacks (2 systems)
Number of channels	2

5. Other Terminals

Control input/output	Both miniature jacks
Key control input/output	Both RCA jacks
Number of channels	2

6. Accessories

Remote control unit (CU-CLD030)	1
Size "AAA" (IEC R03) dry cell batteries	2
RF antenna cable	1
Video cord	1
Audio cord	1
Antenna adaptor (75Ω/300Ω → 75Ω F-type plug)	1
Operating instructions	1
Warranty card	1

SPECIFICATIONS

7. Functions

Remote control unit operations (CU-CLD030)

	Function	Standard play Disc (CAV)	Extended play Disc (CLV)	Compact Disc with Video	Compact Disc
Basic Functions	Single-side play	YES	YES	YES	YES
	Pause	YES	YES	YES	YES
	Stop	YES	YES	YES	YES
	Eject	YES	YES	YES	YES
Search	Fast forward (forward and reverse)	YES	YES	YES	YES
	Chapter/Track skip	YES	YES	YES	YES
	Direct chapter/Track number search	YES	YES	YES	YES
	Frame number search	YES	NO	NO	NO
	Time number search	NO	YES	YES	YES
	Absolute time search	NO	NO	NO	YES
Program	Chapter/Track program play	YES	YES	YES	YES
	Program correction	YES	YES	YES	YES
Repeat	Repeat between 2 points	YES	YES	YES	YES
	Memory repeat	YES	YES	YES	YES
	Chapter/Track repeat	YES	YES	YES	YES
	One-side repeat	YES	YES	YES	YES
	Program repeat	YES	YES	YES	YES
Trick play	Still/Step	YES	NO	NO	NO
	Multi-speed (Forward/reverse 9-level variable)	YES	NO	NO	NO
Time display	Elapsed time display	NO	YES	YES	YES
	Absolute time display	YES*1	NO	NO	YES
	Remaining track time display	NO	NO	YES*4	YES
	Remaining total time display	YES*1	YES*1	YES	YES
	Total number of selections, total time display	YES*1	YES*1	YES	YES
Others	CX system ON/OFF	YES*2	YES*2	—	—
	AUTO DIGITAL/ANALOG switch	YES*3	YES*3	—	—
	Audio channel selection (Stereo, 1/L, 2/R)*5	YES	YES	YES	YES

*1 Only discs with TOC

*2 Valid for analog sound playing a disc with the  mark.

*3 Can only be used with discs with digital sound tracks.

*4 Audio part only

*5 Except for KARAOKE mode

NOTE:

The specifications and design of this product are subject to change without notice, due to improvement.

Published by Pioneer Electronic Corporation.
Copyright © 1990 Pioneer Electronic Corporation.
All rights reserved.

LaserDisc. is a trademark of Pioneer Electronic Corporation.

PIONEER ELECTRONIC CORPORATION 4-1, Meguro 1-Chome, Meguro-ku, Tokyo 153, Japan
PIONEER LASER ENTERTAINMENT, INC. 2265 East 220th Street, Long Beach, California 90810, U.S.A.
PIONEER ELECTRONICS OF CANADA, INC. 505 Cochrane Drive, Markham, Ontario L3R 8E3, Canada