



DVD LD PLAYER

# DVL-909

## Operating Instructions

PAL/NTSC  
(LD:NTSC)

Thank you for buying this Pioneer product. Please read through these operating instructions so you will know how to operate your model properly. After you have finished reading the instructions, put them away in a safe place for future reference.

● This player is not suitable for commercial use.

- First refer to "Before using" on page 10 and "Connecting the Player" on pages 48 ~ 50.
- Refer to pages 11 ~ 16 for basic playback.



## IMPORTANT



The lightning flash with arrowhead, within an equilateral triangle, is intended to alert the user to the presence of uninsulated "dangerous voltage" within the product's enclosure that may be of sufficient magnitude to constitute a risk of electric shock to persons.

**CAUTION**  
RISK OF ELECTRIC SHOCK  
DO NOT OPEN

**CAUTION:**  
TO PREVENT THE RISK OF ELECTRIC SHOCK, DO NOT REMOVE COVER (OR BACK). NO USER-SERVICEABLE PARTS INSIDE. REFER SERVICING TO QUALIFIED SERVICE PERSONNEL.



The exclamation point within an equilateral triangle is intended to alert the user to the presence of important operating and maintenance (servicing) instructions in the literature accompanying the appliance.

## CAUTION

This product contains a laser diode of higher class than 1. To ensure contained safety, do not remove any covers or attempt to gain access to the inside of the product. Refer all servicing to qualified personnel.

The following caution label appear on your player.

Location: rear of the player.

**CLASS 1  
LASER PRODUCT**

**CAUTION** : VISIBLE AND INVISIBLE LASER RADIATION WHEN OPEN.  
AVOID EXPOSURE TO BEAM.

**VORSICHT** : SICHTBARE UND UNSICHTBARE LASERSTRAHLUNG, WENN ABDECKUNG GEOFFNET NICHT DEM STRAHL AUSSETZEN!

**ADVARSEL** : SYNLIG OG USYNLIG LASERSTRÅLING VED ÅBNING  
UNDGÅ UDSÆTTELSE FOR STRÅLING

**VARNING** : SYNLIG OCH OSYNLIG LASERSTRÅLNING NÄR DENNA DEL ÄR ÖPPNAD BETRÄKTA EJ STRÅLEN

**VARO!** : AVATTAESSA ÄL TISTUT NÄKYVÄ JA NÄKYMÄTTÖMÄLLE LASERSATEIL YLLE ÄLÄ KATSO SÄTEESÄN.

VRW1699

**WARNING:** TO PREVENT FIRE OR SHOCK HAZARD, DO NOT EXPOSE THIS APPLIANCE TO RAIN OR MOISTURE.

**CAUTION:** This product satisfies FCC regulations when shielded cables and connectors are used to connect the unit to other equipment. To prevent electromagnetic interference with electric appliances such as radios and televisions, use shielded cables and connectors for connections.

This equipment has been tested and found to comply with the limits for a Class B digital device, pursuant to Part 15 of the FCC Rules. These limits are designed to provide reasonable protection against harmful interference in a residential installation. This equipment generates, uses, and can radiate radio frequency energy and, if not installed and used in accordance with the instructions, may cause harmful interference to radio communications. However, there is no guarantee that interference will not occur in a particular installation. If this equipment does cause harmful interference to radio or television reception, which can be determined by turning the equipment off and on, the user is encouraged to try to correct the interference by one or more of the following measures:

- Reorient or relocate the receiving antenna.
- Increase the separation between the equipment and receiver.
- Connect the equipment into an outlet on a circuit different from that to which the receiver is connected.
- Consult the dealer or an experienced radio/TV technician for help.

## Information to User

Alteration or modifications carried out without appropriate authorization may invalidate the user's right to operate the equipment.

## CAUTION

- Use of controls or adjustments or performance of procedures other than those specified herein may result in hazardous radiation exposure.
- The use of optical instruments with this product will increase eye hazard.

## PAL/NTSC SYSTEM SWITCHING

### TV SYSTEM switch

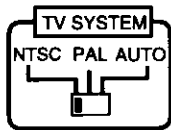

Use this switch to change mode according to the type of TV and disc to be used.

Video output changes as follows according to the playback disc's recorded format.

Disc		Output format		
Type	Format	Position of TV SYSTEM switch		
		NTSC	PAL	AUTO
Video CD	NTSC	NTSC	MOD, PAL	NTSC
	PAL	NTSC	PAL	PAL
DVD	NTSC	NTSC	MOD, PAL	NTSC
	PAL	—	PAL	PAL
LD	NTSC	NTSC	—	NTSC
CD, No disc		NTSC	PAL	NTSC or PAL
Stop mode		NTSC	PAL	NTSC or PAL

1. NTSC → PAL, PAL → NTSC conversion is possible on Video CDs.
2. NTSC/PAL conversion is not possible on DVDs.
3. When the TV SYSTEM switch is set to the AUTO position, the disc's format will be output as is.  
When a CD or disc is not loaded, the previous video output format will be selected.

#### About MOD. (Modulation) PAL

- **\*SHRINK**  
Most models of the newly developed countdown PAL TV system detect 50Hz(PAL)/60Hz(NTSC) and automatically switch vertical amplitude, resulting in a display without vertical shrinkage.
- If you PAL TV does not have a V-Hold control, you may not be able to view NTSC disc because the picture may roll. If the TV has V-Hold control, adjust it until the picture stops rolling. On some TVs, the picture may shrink vertically, leaving black bands at the top and bottom of the screen. This is not a malfunction; it is caused by the NTSC → PAL conversion.

This product incorporates copyright protection technology that is protected by method claims of certain U.S. patents and other intellectual property rights owned by Macrovision Corporation and other rights owners. Use of this copyright protection technology must be authorized by Macrovision Corporation, and is intended for home and other limited viewing uses only unless otherwise authorized by Macrovision Corporation. Reverse engineering or disassembly is prohibited.

# See What You Can Do

## Dolby Digital\*

Connect to a Digital Surround Amp and Surround Processor for 5.1ch Dolby Digital Surround entertainment.

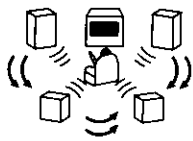

## Virtual Dolby Surround\*<sup>P.33</sup>

With Virtual Dolby Surround you can enjoy a virtual sound presence that is three dimensional, even on the stereo system you are presently using. **TruSurround** with SRS (S) There may be no effect (or little effect) in some cases.



## GUI Operation<sup>P.35</sup>

While viewing Pioneer's original GUI on-screen displays, you can perform operations by remote control. Even if there is no menu recorded on a disc, you can still perform GUI operation with the menu provided by the player.

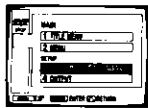

## Continuous Play of Both Sides of LDs\*

You can enjoy continuous playback of both sides of a laserdisc. <sup>P.12</sup>



## Last Memory Play\*<sup>P.16</sup>

If you stop video playback, this lets you resume play back from where it was stopped.



## Still Frame, Single Frame Advance\*

You can view still frames, and advance one frame at a time. <sup>P.23</sup>



## Repeat Play\*<sup>P.22</sup>

Wide range of Repeat Play possibilities.



## Random Play\*<sup>P.24</sup>

You can enjoy playback of tracks (or chapters) in random order.



## Program Play\*<sup>P.21</sup>

Lets you play back selected titles and chapters in any desired order.



## Multi-Aspect\*<sup>P.26</sup>

You can select between Regular, Wide, and Letter Box display formats.



## Cinema Mode & Animation Mode\*

Lets you select the ideal picture quality for watching movies and animation movies. <sup>P.31</sup>



## Condition Memory<sup>P.27</sup>

Records and automatically recalls settings for DVDs you often watch.

- Multi-Aspect
- Cinema Mode/Animation Mode
- Multi-language Subtitles
- Multi-language
- Location

## Multilingual Subtitles\*

You can select a desired subtitle language when watching movies and other videos. <sup>P.29</sup>

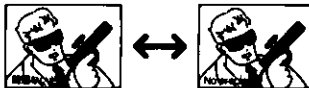

## Multi-Angle\*<sup>P.29</sup>

Lets you view scenes from different camera angles.

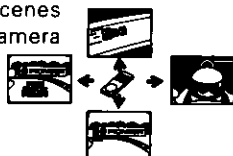

## Multiple Languages\*<sup>P.28</sup>

With discs that have multiple language soundtracks recorded on them, you can select the desired language.



## Parental Level\*<sup>P.43</sup>

Lets you select a "parental level" (user restriction level) to prevent children from viewing undesirable material.

## PBC Video CD Compatibility<sup>P.18</sup>

Ready to play Video CDs (Version 2.0) with PBC (Play Back Control). Two types of playback are possible depending on the disc.



## V-DNR\*<sup>P.33</sup>

Depending on the software playing, this enables picture quality adjustment.

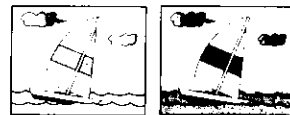

## Power On Demo Display

Switching ON the Power On Display provides a wide range of indications.

To switch to power ON demo indications, press the power switch while pressing the ►►►► button.

Press any button to cancel the demo indications.

\* This mark indicates this may not be possible with certain discs.

\*\*SRS Labs, Inc.'s TruSurround system **TruSurround** has been adopted as virtual technology.

TruSurround is a trademark of SRS Labs, Inc. SRS and the SRS symbol are registered trademarks of SRS Labs, Inc. in the United States and selected foreign countries.

TruSurround is incorporated under license from SRS Labs, Inc.

Permission for use of TruSurround technology has been registered through SRS Labs, Inc.

# For Proper and Long Use

## ■ DO NOT MOVE THE UNIT DURING PLAYBACK

During playback, the disc rotates at high speed. Do NOT lift or move the unit during playback. Doing so may damage the disc.

## ■ WHEN MOVING THE UNIT

When changing places of installation or packing the unit for moving, be sure to remove the disc and return the disc table to its original position in the player. Then, switch the power OFF. **Check that the “-OFF-” indication on the display goes off**, then disconnect the power cord.

## ■ INSTALLATION PLACE

- Select a stable place to the side of a TV set or stereo system to be connected to the unit.
- When using the unit with a stereo system, install the speakers a little bit away from the TV.
- Do NOT install the unit on top of a TV or color monitor. Install the unit away from equipment that may be affected by magnetism, such as a cassette deck.

## ■ AVOID INSTALLING IN A PLACE THAT IS:

- Exposed to direct sunlight
- Exposed to humidity or where ventilation is poor
- Extremely hot or cold
- Exposed to vibration
- Exposed to dust
- Exposed to oily smoke, steam or heat (for example, a kitchen)

## ■ DO NOT PLACE AN OBJECT ON TOP

Do NOT place an object on the unit.

## ■ DO NOT BLOCK VENTS

Do NOT use the player on top of a long-fibered carpet, bed or sofa, and do not cover it with a cloth etc. This will prevent heat radiation and could result in damage.

## ■ AVOID HEAT

Do NOT place the unit on equipment generating heat, such as an amplifier.

When installing the unit in a rack, place it on the lowest shelf possible (however, not where it is exposed to dust) and separated from the amplifier to avoid the heat generated by the amplifier or other audio equipment.

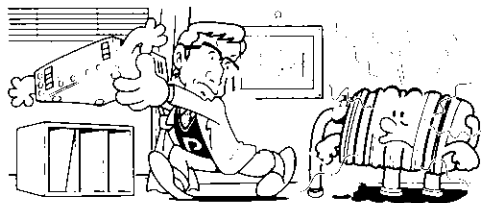

## ■ CAUTION: WHEN PLACING THE UNIT IN A STEREO RACK WITH GLASS DOORS

Be sure there is ample space between the unit and the glass doors when opening the disc table using the remote control.

If the disc table opens against strong resistance, **such as a closed glass door**, damage to the unit may result.

## ■ CONDENSATION

Moisture will form in the operating section of the player if the player is brought from cool surroundings into a warm room or if the temperature of the room rises suddenly. When this happens, the player's performance will be impaired.

To prevent this, let the player stand in its new surroundings for about an hour before switching it on, or make sure that the room temperature rises gradually.

Condensation may also form during the summer if the player is exposed to the breeze from an air conditioner. In such cases, change the location of the player.

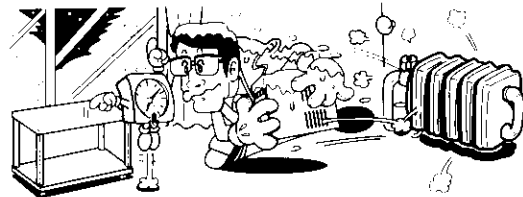

## ■ SWITCH THE POWER OFF WHENEVER NOT USING THE UNIT

Depending on the strength of the TV broadcast signal, having the TV set on while the power of the unit is ON may produce stripes on the TV screen. However, this is not a malfunction of this unit or the TV set. In such a case, switch the power of the unit OFF.

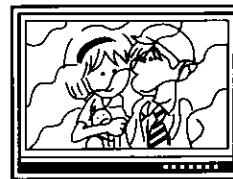

## POWER-CORD CAUTION

Handle the power cord by the plug. Do not pull out the plug by tugging the cord and never touch the power cord when your hands are wet as this could cause a short circuit or electric shock. Do not place the unit, a piece of furniture, etc., on the power cord, or pinch the cord. Never make a knot in the cord or tie it with other cords. The power cords should be routed in such a way that they are not likely to be stepped on. A damaged power cord can cause a fire or give you an electrical shock. Check the power cord once in a while. When you find it damaged, ask your nearest PIONEER authorized service center or your dealer for a replacement.

## For Proper and Long Use

### CARE OF DISCS

#### How to hold discs

When loading or removing discs, try not to touch their playing surfaces.

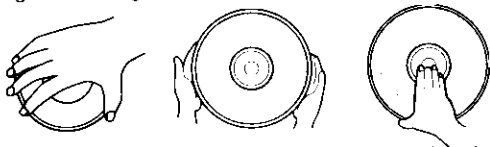

#### Cleaning

Fingerprints or other dirt on the disc may affect sound and picture quality.

To clean your discs, use a soft clean cloth to wipe them. If necessary, moisten a soft cloth with diluted neutral detergent to remove heavy dirt or fingerprints.



Do not wipe in a circular direction  
(Concentric scratches in the disc groove tend to cause noise.)  
Gently wipe from the  
inside toward the outer edge.

Discs must not be cleaned with record cleaning sprays, or static prevention sprays, etc. Also do not use volatile liquids such as benzine, or thinner, etc.

#### NEVER PLAY CRACKED OR WARPED DISCS.

- The disc revolves in the player at a high speed when it is played. Never play a cracked, scratched or warped disc. This may damage the player or cause it to malfunction.

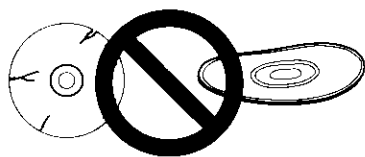

#### Do not play a CD with a special shape

Do not play a CD having other shape than a circular disc, such as a heart shaped disc. Otherwise malfunction may occur.

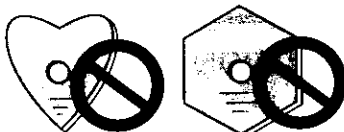

#### After using discs, store them upright

After playing a disc, always remove it from the player and return it to its jacket. Then store it standing upright away from heat and humidity.

- Store discs carefully. If you store discs at an angle, or stacked on top of each other, discs may become warped even when in their jackets.
- Do not leave discs in locations such as the seat of car, which may become excessively hot.

#### CAUTION WHEN USING THE DISC

All rights reserved.

Unauthorized public performance, broadcasting or copying is a violation of applicable laws.

#### CLEANING CARE

Use a soft, dry cloth for cleaning. For stubborn dirt, soak the cloth in a weak detergent solution; wring well first and wipe. Use a dry cloth to wipe it dry. Do not use any volatile agents such as benzine or paint thinner, as they may damage the surface of the player.

#### LD/CD lens cleaner

The player's pickup lens should not become dirty in normal use, but if for some reason it should malfunction due to soiling, consult your nearest PIONEER authorized service center. Lens cleaners for LD/CD players are commercially available, but special care should be exercised in their use since some may cause damage to the lens.

### Notes on using the optional optical cable

- Do not route the cable around sharp objects. When storing, wind the cable so that it has a diameter of at least 15 cm (6 inches).
- When connecting, push the plug all the way into the terminal.
- Please don't use cables with a length of over 3 m (10 feet).
- If moisture or dust has collected on the plug, wipe it with a soft cloth before connecting.

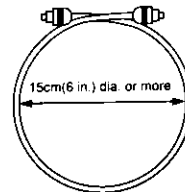



# Disc Types Compatible with this Unit

This player is DVD, LD, CD, and Video CD compatible. The marks shown on the right are found on disc labels or on disc jackets.

- This player can play all discs bearing the marks on the right without the need for an adaptor.
- To prevent malfunction, do not use an 8 cm (3 in.) adaptor (for CDs).

This unit is NTSC/PAL compatible (TV color system). LDs and CDVs are NTSC compatible only (refer to page 3). You cannot use discs other than those shown on the right.  
\* During DVD playback, data transfer is at 4.7 Mbit per second.

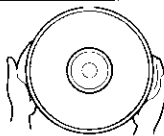
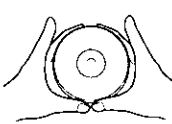
## Handling the discs

	LD	DVD, CD, etc.
<b>Holding with both hands</b>		
<b>Holding with one hand</b>		



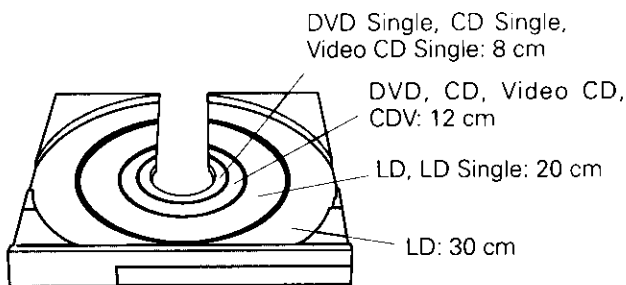



## Disc Table



### Note

- ◆ You cannot play DVDs that do not bear the Region No. (refer to terminology on page 56) indicated on the player.

**Discs other than those mentioned at right cannot be played.** To prevent damage to the player, do not play a disc type other than those above. (E.g.) DVD audio, CD-ROM, LD-ROM, DVD-ROM, High Definition LD etc.

Types of playable discs and their marks	Diameter/Playable sides	Playback time
	DVD VIDEO	Digital audio Digital video (MPEG 2)
	12 cm (5 in.)/ single-sided	1 layer 2 layers 133 min.* 242 min.*
	12 cm (5 in.)/ double-sided	1 layer 2 layers 266 min.* 484 min.*
	8 cm (3 in.)/ single-sided	1 layer 2 layers 41 min.* 75 min.*
8 cm (3 in.)/ double-sided	1 layer 2 layers 82 min.* 150 min.*	Digital audio Digital video (MPEG 2)
	VIDEO CD 12 cm (5 in.)/single-sided	Digital audio Digital video (MPEG 1) Max. 74 minutes
	VIDEO CD single 8 cm (3 in.)/single-sided	Digital audio Digital video (MPEG 1) Max. 20 minutes
	CD 12 cm (5 in.)/ single-sided	Max. 74 minutes
	CD single 8 cm (3 in.)/ single-sided	Max. 20 minutes
	CDV 12 cm (5 in.)/ single-sided	Digital audio (max. 20 min.) (Audio part) Digital audio + video (max. 5 min.) (Video part)
	VSD (Video Single Disc) 12 cm (5 in.)/ single-sided	Digital audio + video (max. 5 min.) (Video part)  In these operating instructions, the VSD is treated as a kind of CDV.
     LD	LD 30 cm (12 in.)	CAV 1 hour on a double-sided disc CLV 2 hours on a double-sided disc
	LD 20 cm (8 in.)	CAV 28 min. on a double-sided disc CLV 40 min. on a double-sided disc
	LD Single 20 cm (8 in.)	CAV 14 min. on a double-sided disc CLV 20 min. on a double-sided disc

# Contents

## Basic Operation

Features for great entertainment the easy way

Playing LDs

Chapter (Track) Skip Forward/Skip Back

Continuing Playback from where you Stopped

## Detailed Operation

Convenient, fun-to-use functions

Searching for a Desired Video Scene/Audio Track Part 1

Playback in a Desired Order (Program Play)

Still/Step Slow Playback

## Setting

Settings for easy operation

Multi-Aspect Setting for Wide Screen TV Software

Selecting Languages (Multi-Language)

Selecting Subtitle Language (Multi-Language Subtitles)

Viewing Information

Quick LD Side Changing (Quick Turn)

Outline of GUI (Graphical User Interface) Operation

## Set Up

Connection example 2. To an amp with Dolby Digital (AC-3) inputs

Names and Functions Front panel

Display Window

## Other Information

Troubleshooting

Specifications



Applicable discs



12

14

16

19

21

23

26

28

29

30

34

35

49

51

52

54

57

Basic  
Operation

Detailed  
Operation

Setting

Set Up

Other  
Information

\* Does not operate with certain disc functions.

# Before Using

## Checking accessories

Audio cord

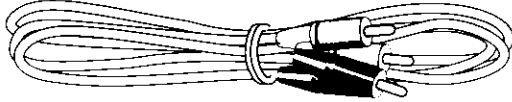

Video cord

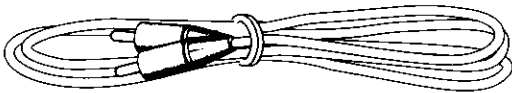

Power cord

<Flat blade 2-pin AC plug model>

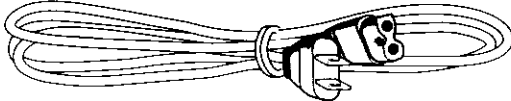

<Round blade 2-pin AC plug model>

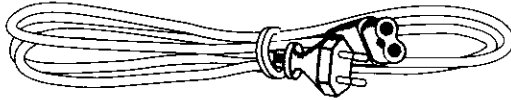

Remote control unit

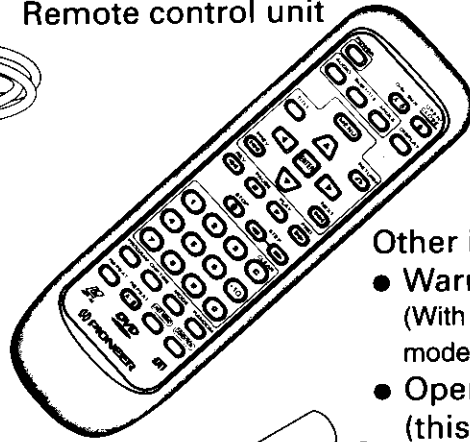

Batteries....2

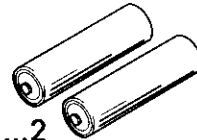

### Other included items

- Warranty card  
(With region number "1" models only.)
- Operating Instructions  
(this manual)

## Inserting batteries into the remote control

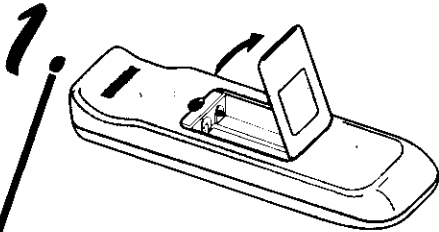

While pressing the back cover, pull out in the direction indicated by the arrow.

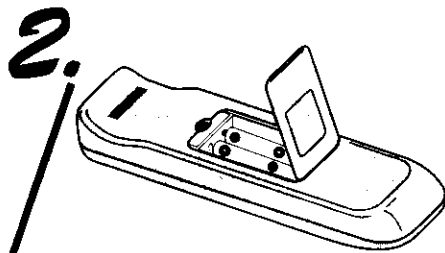

### Insert batteries.

Make sure to match the plus (+) and minus (-) polarity guides on the batteries with the marks inside the battery compartment.

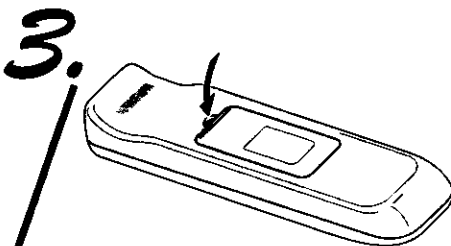

Close the cover.

### Notes

- ◆ Do not mix old and new batteries.
- ◆ Even batteries of the same type will differ in voltage. Do not mix old batteries with new batteries.
- ◆ When not using the remote control for a long period of time (over 1 month), remove the batteries to avoid possible damage from battery corrosion. If battery leakage occurs, wipe the battery liquid from the battery compartment, then insert new batteries.

## Basic Operation

Playing LDs .....	12
Playing DVDs, CDs and Video CDs .....	13
Chapter (Track) Skip Forward/Skip Back .....	14
Stopping Playback & Switching Power OFF .....	15
Continuing Playback from where you Stopped.....	16

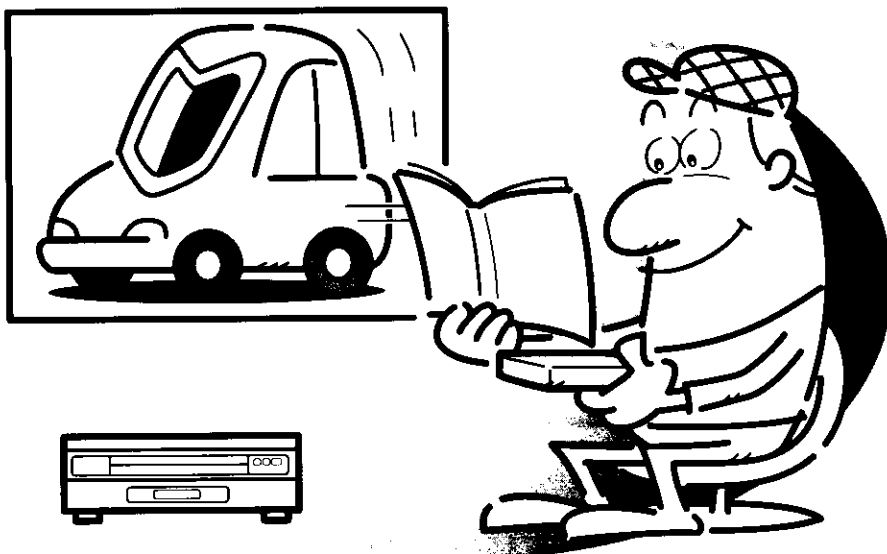

# Playing LDs

1.

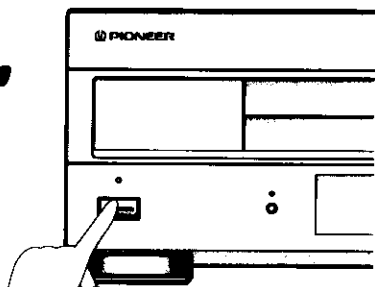

## Press the POWER switch

- When the unit is in STANDBY, you can use the remote control's POWER button to switch between power ON/STANDBY.

- You can switch the display OFF by pressing the FL OFF button. If you do this, the indicator above the button lights.



2.

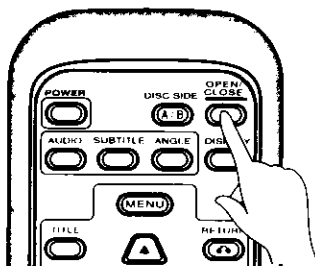

## Press the OPEN/CLOSE ▲ button.

- Press the LD ▲ button on the player.
- The disc table comes out.

- With a double-sided LD, load with the A side facing up and the B side facing down. Recorded A and B sides are on opposite sides of the disc itself.

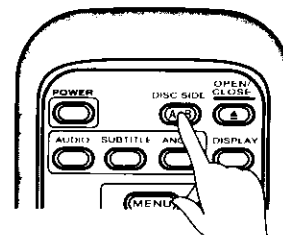

Pressing the remote control's DISC SIDE A/B button switches between sides A and B. The A side or B side indicator lights on the player to confirm the selected side.

3.

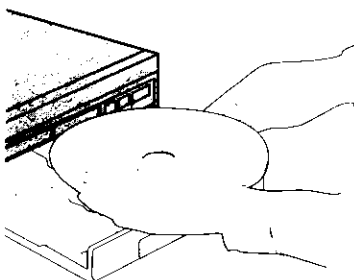

## Load a disc.

- Load a single-sided disc with the label facing up, or load a double-sided disc with the label for the desired side facing up, using the disc table guide to align the disc.

### Note

- Not aligning a disc with the disc guide, or loading two discs at once will result in damage to the disc(s) and player.

4.

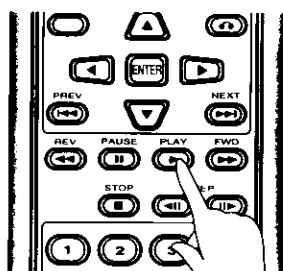

## Press the PLAY ► button.

- Press the PLAY/PAUSE ►/|| button on the player.
- When the A side of a double-sided disc has finished playing, playback of the B side automatically starts.

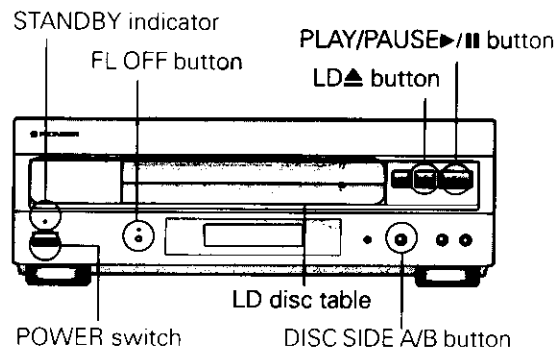

# Playing DVDs, CDs and Video CDs

1.

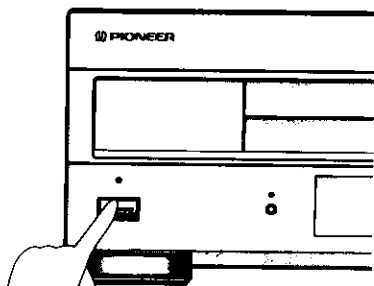

**Press the POWER button.**

- When the unit is in STANDBY, you can use the remote control's POWER button to switch between power ON/STANDBY.

● So as not to spoil the atmosphere of a video, you can switch the display OFF by pressing the FL OFF button. If you do this, the indicator above the button lights.

2.

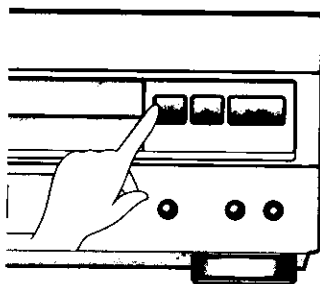

**Press the DVD/CD button.**

- The DVD/CD disc table comes out.
- The LD disc table and the DVD/CD disc table come out if you press the remote controls OPEN/CLOSE button.

**Note**

- ◆ The time taken for playback to start may differ depending on the type of disc previously played and the type of disc currently loaded.

3.

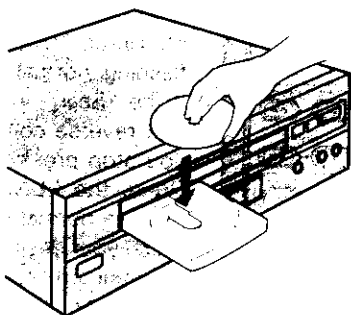

**Load a disc.**

- Load a disc with the label side facing up, using the disc table guide to align the disc.

**Notes**

- ◆ You cannot play DVDs that have no region number (refer to page 56).
- ◆ You cannot play DVDs that contain anything other than video data.
- ◆ During operation, the following marks may appear on the TV screen.

Ⓢ :When you perform an operation that is not possible with the player.

Ⓢ :When you perform an operation that is not possible with the disc.

4.

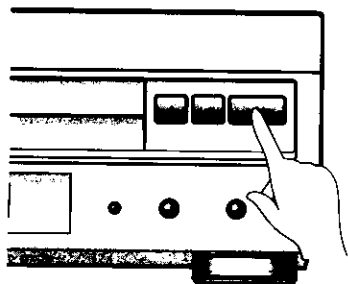

**Press the PLAY/PAUSE button.**

- Press the PLAY/▶ button on the remote control unit.
- Depending on the disc, a menu may be displayed. If a menu is displayed, refer to page 18.

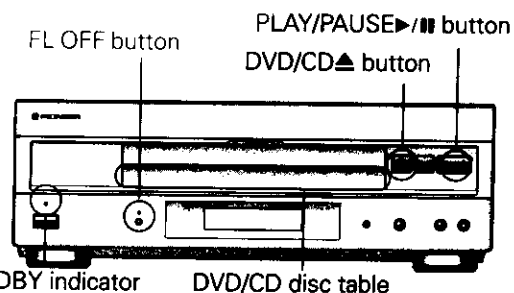
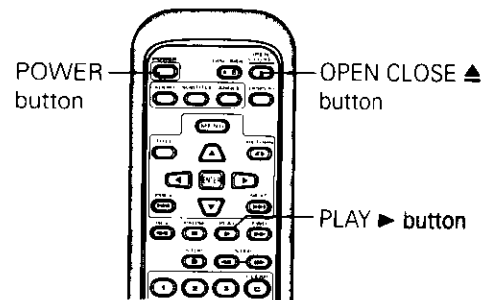

STANDBY indicator DVD/CD disc table

# Chapter (Track) Skip Forward/Skip Back

## Skipping forward to the next chapter (track)

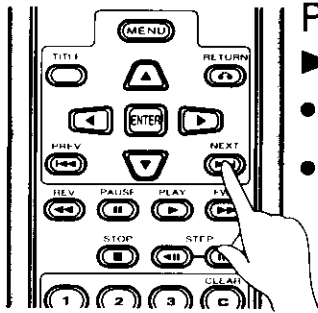

Press the NEXT **▶▶** button.

- Press to skip forward to the next chapter (track).
- Same operation as the FWD **▶▶▶▶** button on the player.

## Fast forward

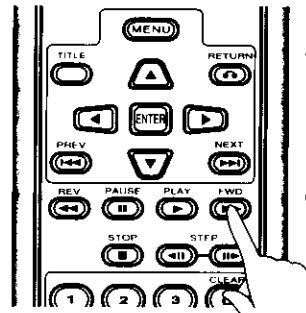

Continue pressing the FWD **▶▶▶▶** button.

- If you stop pressing while the on-screen "Scan" indication is flashing, normal play resumes.
- If the "Scan" indication lights, fast forward continues even if you stop pressing the button. Press the PLAY **▶** button to resume normal play when you reach your desired location.
- Continue pressing the FWD **▶▶▶▶** button on the player to fast forward.

## Skipping back to the previous chapter (track)

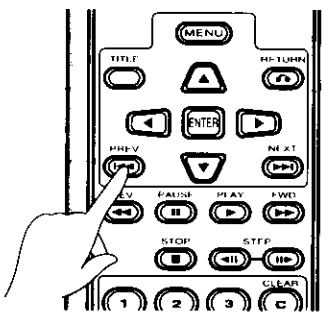

Press the PREV **◀◀** button.

- Press once to skip back to the start of the chapter (track) currently playing.
- Press again to skip back to the start of the previous chapter (track).
- Same operation as the REV **◀◀◀◀** button on the player.

## Fast reverse

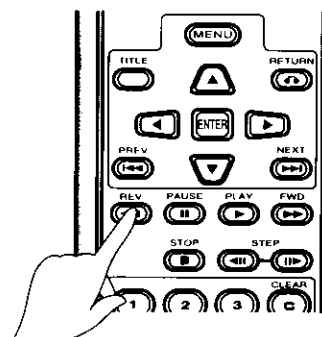

Continue pressing the REV **◀◀◀◀** button.

- If you stop pressing while the on-screen "Scan" indication is flashing, normal play resumes.
- If the "Scan" indication lights, fast reverse continues even if you stop pressing the button. Press the PLAY **▶** button to resume normal play when you reach your desired location.
- Continue pressing the REV **◀◀◀◀** button on the player to fast reverse.

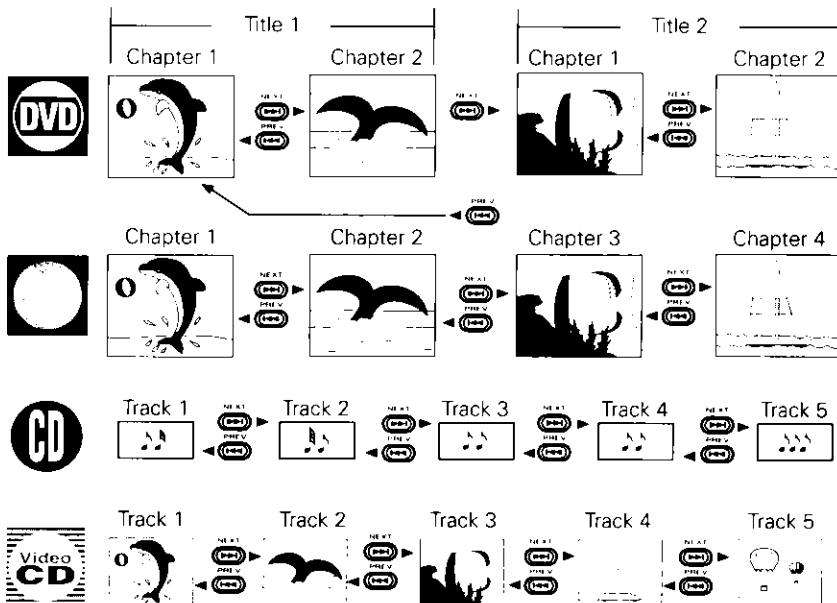

FWD **▶▶▶▶** button

REV **◀◀◀◀** button

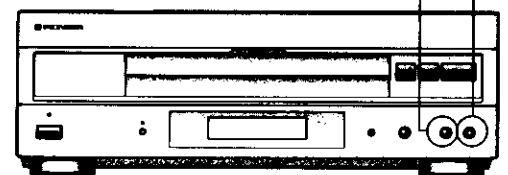

# Stopping Playback & Switching Power OFF

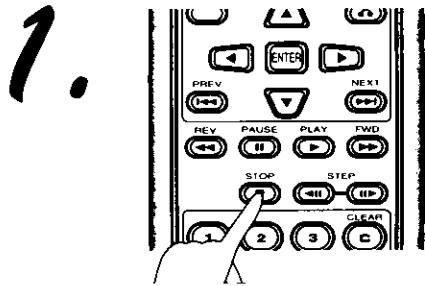

Press the STOP ■ button.

- Playback stops.

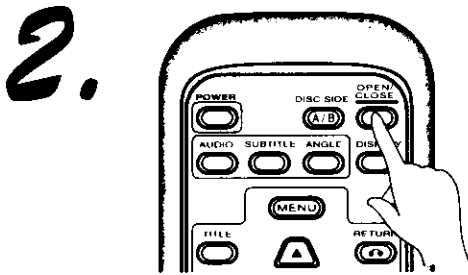

Press the OPEN/CLOSE ▲ button.

- Press the LD ▲ button or the DVD/CD ▲ button on the player.
- The disc table comes out.

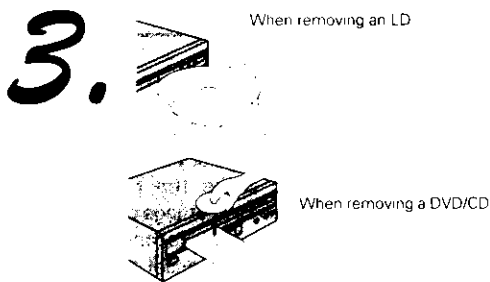

Remove the disc.

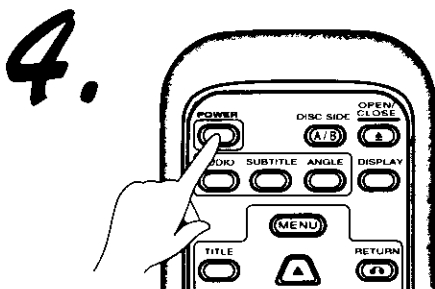

Press the POWER button.

- The disc table goes back in, power switches STANDBY, and the STANDBY indicator lights.

**Note**

- ◆ You can continue play from where you stopped part away through (refer to page 16).
- ◆ When switching power OFF on the main unit, be sure to do it after first pressing the POWER button on the remote control to light the STANDBY indicator.

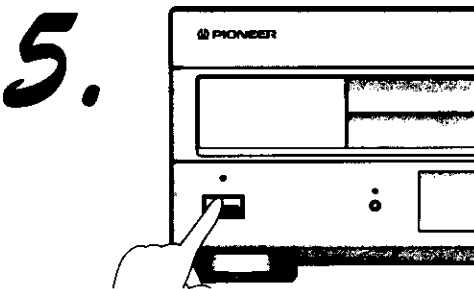

Press the POWER switch on the player.

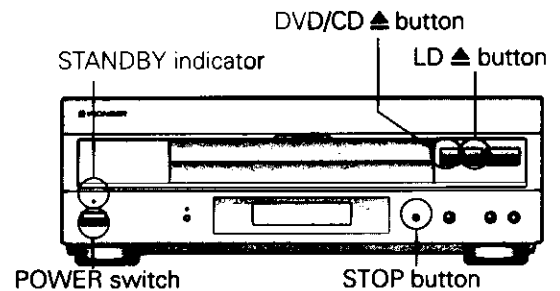

# Continuing Playback from where you Stopped

## Memorizing the place where you stopped watching (LAST MEMORY)

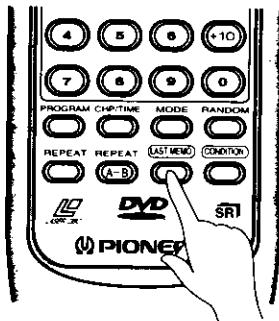

### Press the LAST MEMO button during play.

- The LAST MEMORY indicator lights on the player.
- Press the POWER button on the remote control unit to switch power STANDBY, or press the STOP button to stop playback.

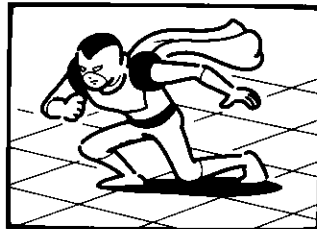

- With DVDs, LAST MEMORY memorizes video, audio, display, mode, and other settings as well as the place where playback stopped.
- Even with a disc you have memorized with LAST MEMORY, playback begins at the start of the disc if you press the PLAY button.
- When you continue playback from the point where you stopped, LAST MEMORY is automatically canceled for that disc.
- If you register more than five DVDs in LAST MEMORY, details of the latest disc are memorized, while details of the least recent disc (the disc you registered first) are erased.
- If you eject an LD or Video CD, memorized details are erased.
- With DVDs, LAST MEMORY may not function with certain titles.

### Notes

- ◆ Resuming play is not possible with CDs.
- ◆ During Video CD PBC play, Last Memory play may not be possible.
- ◆ If there is a power outage or you disconnect the power cord while the player is operating, Last Memory settings cannot be memorized. Before you disconnect the power cord, be sure to cancel the "OFF" indication in the display window by pressing the POWER switch on the player after pressing the POWER button on the remote control.
- ◆ You cannot use Last Memory if you switch power OFF with the POWER switch on the player during play. To switch power OFF, first press the POWER button on the remote control, and then the POWER switch on the player.

## Resuming playback from where you stopped

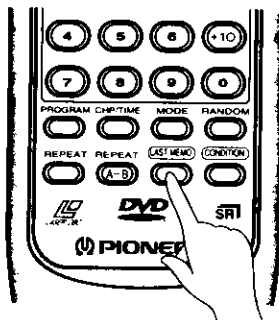

### Press the LAST MEMO button during STOP.

- When power is STANDBY or LAST MEMO indicator lights in the display, if you press the LAST MEMO button, power automatically switches ON, and play resumes from the place you stopped watching.

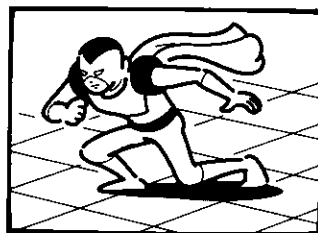

LAST MEMO indicator

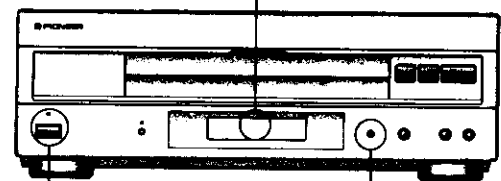

POWER switch

STOP button



## Detailed Operation

Playback by Menu Selection .....	18
Searching for a Desired Video Scene/Audio Track Part1 .....	19
Searching for a Desired Video Scene/Audio Track Part2 .....	20
Playback in a Desired Order (Program Play) .....	21
Repeat Play .....	22
Still/Step Slow Playback .....	23
Random Play .....	24

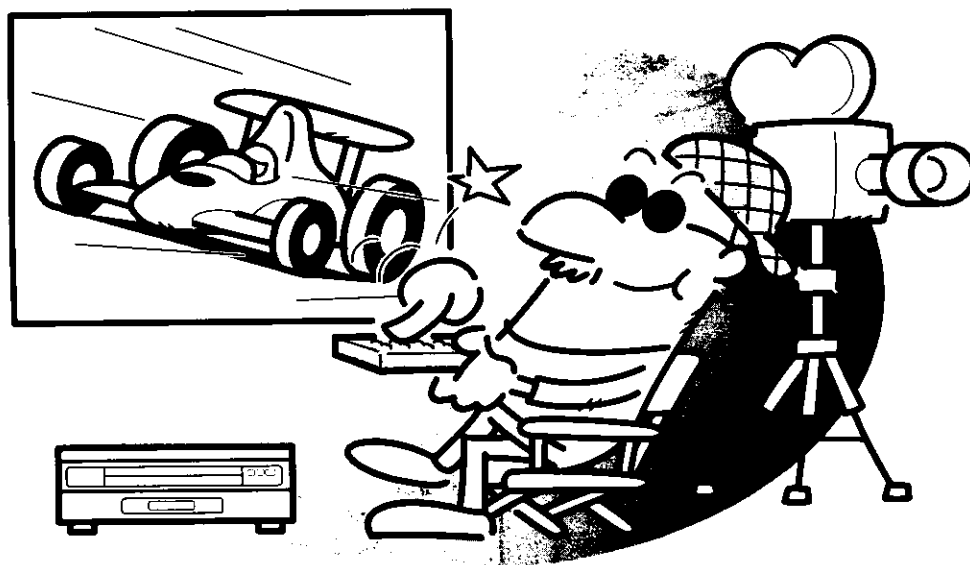

DVD

Video  
CD

# Playback by Menu Selection

DVDs and Video CDs, depending on the disc, feature selection menus. This player lets you choose a desired title or track by selecting from a menu.











## Playing Back from Menu Display

### ① Press .

- A menu is displayed. This menu is recorded on the disc. Menus differ depending on the disc.
- With Video CDs that have Play Back Control, PBC is indicated in the display window.



### ② Title (track) selection with the number buttons.

- When selecting a number higher than 10, use the  button.
- When selecting 10, press  → .
- When selecting 17, press  → .
- When selecting 20, press  →  → .
- The selected title or track starts playing.
- With DVDs, you can also select numbers with the  and  buttons and then press .

## Returning to Menu Display during Playback

### In case of DVDs

#### ① Press .

#### ② Press .

- Press  again for a menu of title contents. Perform operations following indications provided in the menu.

### In case of Video CDs

#### Press .

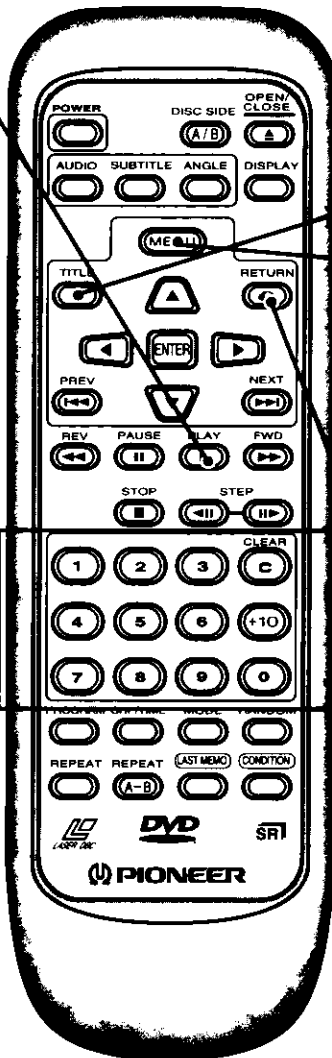

- Pressing the  button during the PBC play shows the menu.



### Notes

- ◆ During Video CD PBC play, Program, Random and Repeat Play functions do not operate. This is because you can use menus for interactive operation.
- ◆ With Video CDs when PBC is ON, player operation differs depending on the disc. For details, read the instructions that come with the disc.
- ◆ With DVDs, menu indications may not be displayed.



- You can also play Video CDs without calling up a menu by pressing a number button during STOP. For example, to start playback from track 1, press number button .
- Depending on the title, you can also make a selection using a menu. To do this, press the  button when indications are displayed to call up a menu, and select the desired title.

DVD

# Searching for a Desired Video Scene/Audio Track Part 1

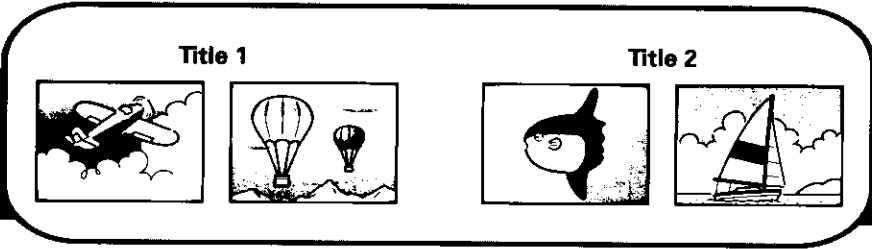

## Direct Search with Title Numbers

- 1 Press **TITLE** during play. (When in the Stop mode, move to step 2 without pressing **TITLE**.)

- Title numbers flash on screen.
- 2 Selecting title numbers directly with the number buttons.
  - When selecting title number 3, press **3**.
  - When selecting title number 10, press **30** + **0**.
  - When a title number is flashing, if you continue pressing **TITLE**, title numbers advance one at a time. When you reach the desired title number, you can select it by pressing **ENTER**.

## Search with Menu

- 1 Press **TITLE**. (When in the Stop mode, move to step 3.)

- 2 Press **MENU** during play.

- 3 Select a title number using **▲** **▼** buttons.

- 4 Press **ENTER**.

- Playback of the selected title starts.

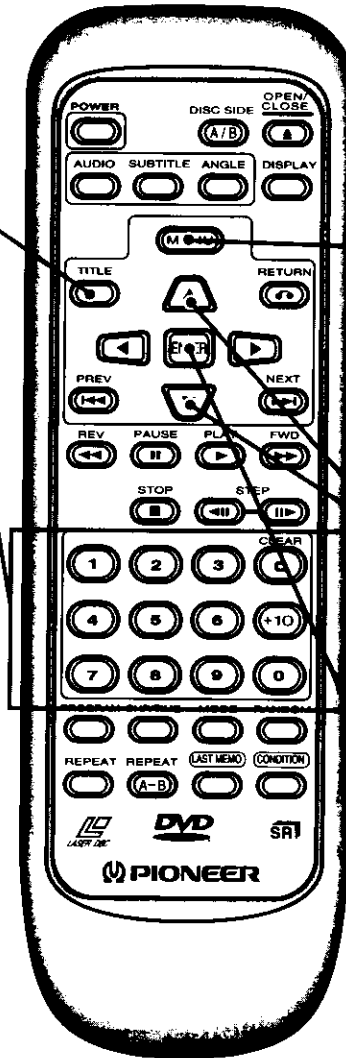

Detailed Operation

### Notes

- You cannot playback successive titles.
- To playback multiple successive titles, program the titles and then perform Program playback. (Refer to page 21.)
- With certain DVDs, search operation may stop. In this case, the **S** mark appears.
- Depending on the disc, menu may not be displayed.

- You can also select titles directly using the number buttons. The selected title soon starts playing.
- Depending on the title, you can also make a selection using a menu. To do this, press the **MENU** button when indications are displayed to call up a menu, and select the desired title.

Chapter 1



Chapter 2



Chapter 3



Chapter 4

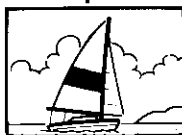

## Searching for a Desired Video Scene/Audio Track Part 2

Three ways to search a DVD or Video CD; normal search, direct search and time search are possible.  
 For CD, direct search only is possible.  
 Four ways to search an LD; normal search, direct search and time/frame search are possible.

### Chapter/Track Number Search (Normal Search)

#### Direct search using the number buttons

Example 1: To select chapter/track number 3, press **3**.

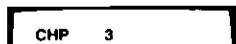

Example 2: To select chapter/track number 17, press **+10** > **7**.

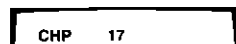

- With DVDs, when performing this operation during the Stop mode, refer to "Searching for a Desired Video Scene/Audio Track Part 1" in page 19.

#### When the Chapter/Track number is high

① Press **CHP/TIME**.

- Chapter/Track number flashes.
- With DVDs, a menu may be displayed during the Stop mode. In this case, refer to "Chapter Number Search with Menu" on the right.

② Specifying Chapter/Track numbers with the number buttons

Example 1. Selecting Chapter/Track 31 press **3** > **1**.

Example 2. Selecting Chapter 187 press **1** > **8** > **7**.

③ Press **PLAY**.

- The selected Chapter/Track starts playing.

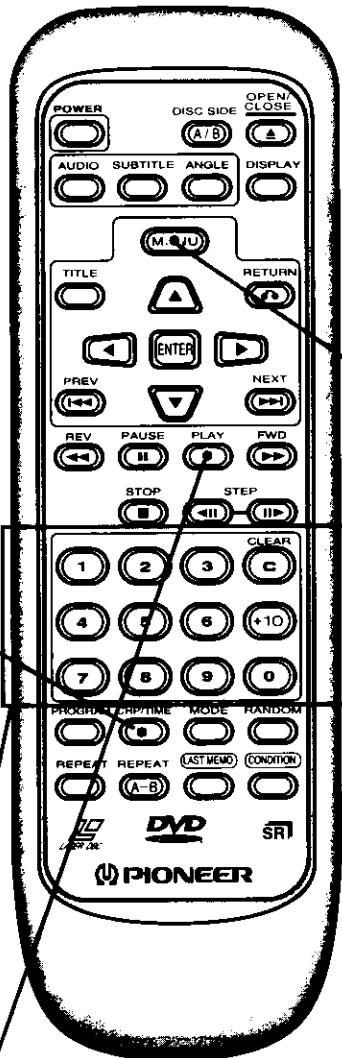

### Chapter Number Search with Menu

You can perform this with DVDs only.

① Press **CHP/TIME**.

- When in the Stop mode, proceed to step 3.

② Press **MENU**.

- Chapter menu is displayed.

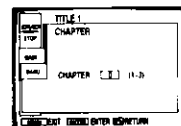

③ Make a selection following on-screen indications.

- With certain titles, there may be no menu display. In this case, perform the operations described at left.

### Time Number Search/Frame Number Search

① Press **CHP/TIME** twice.



- With DVDs or LDs that have no chapters, time is displayed after pressing the button once.

② Select the desired time number/frame number with the number buttons.

Example 1: To select 21 minutes 43 seconds, press **2** > **1** > **4** > **3**.

Example 2: To select frame number 423, press **4** > **2** > **3**.

- With DVDs, you cannot search for chapters that overlap titles.

③ Press **PLAY**.

- Playback starts from the selected elapsed play time or selected frame.

#### Notes

- ◆ Time Search is not possible with CDs.
- ◆ With DVDs, Search may not be possible with certain titles. In this case, the **S** mark is displayed.
- ◆ When performing DVD or Video CD Time Search, playback may start from a slightly different time than that specified.
- ◆ When a DVD is not playing (in the STOP mode), Time Search is not possible.
- ◆ During Video CD PBC play, search operations described above are not possible.

- To clear Title and Chapter/Track/Time/Frame indications when they are flashing, press the **C** twice.
- Depending on the title, you can also make a selection using a menu. To do this, press the **MENU** button when indications are displayed to call up a menu, and select the desired title.



## Playback in a Desired Order (Program Play)

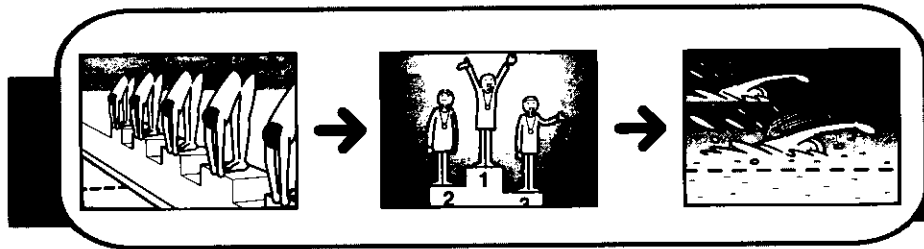

## Programming (DVD)

① Press **PROGRAM**.

② Select the program type with the number buttons and press **ENTER**.

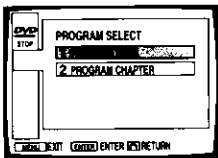

- If you select a title, move directly to step ③, and input the title number.
- If you select a chapter, the title number is indicated, and the chapter input menu is displayed. If the title number indicated is the one desired, move directly to step ③. If you want to change the title number, press the **HELD** button, and then use the number buttons or **LEFT**/**RIGHT** buttons to change the number as desired.

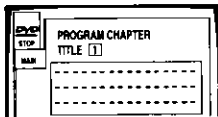

③ Program titles or chapters using the number buttons.

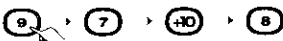

When programming 9, 7, 18.

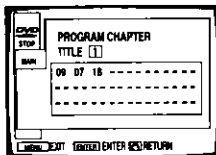

④ Press **ENTER**.

- Playback starts in the set order.

## Confirming, adding to, and canceling programs

① Press **PROGRAM**.

② With DVDs, select the type of program and press **ENTER**.

- You can confirm programs by performing the above operations.

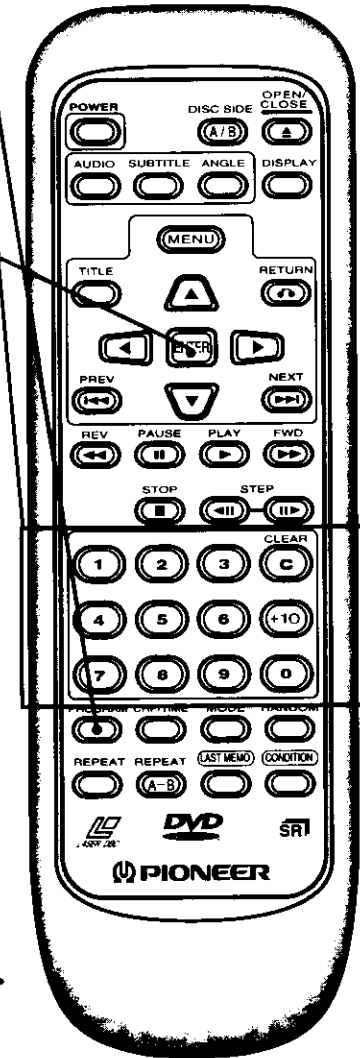

③ To add to programs, make selections with the number buttons.

④ To cancel a program, select the desired program with **LEFT**/**RIGHT** and press **CLEAR**.

## Program setting (Video CDs, CDs, LDs)

① Press **PROGRAM**.

② Programming tracks 9, 7 and 18 in order.



Press the number buttons in order.

- With double-sided LDs, program the disc side together with each track number. For example, for track 9 on side B,



③ Press **ENTER**.

- Playback starts in the specified track order.

## To cancel an entire program

During STOP, press **CLEAR**.

- The entire program for the disc loaded in the disc table is cleared.

## Stopping program play

Press **STOP**.

- Program play stops.

### Notes

- ◆ You cannot program when playing a Video CD (during PBC).
- ◆ When moving chapters, a chapter not programmed may appear on screen, but this is not a malfunction.
- ◆ With DVDs, programming may not be possible with certain titles. In this case, the **!** mark is displayed.
- ◆ With DVDs, you cannot program chapters that are in different titles.

- You can program up to 24 steps.
  - If you press the wrong number button, press **CLEAR** and then press the correct number button.
  - Program play is not possible with discs that have no chapter numbers recorded on them.
- Pressing PAUSE during programming:**  
If you press PAUSE instead of a number button, **||** is displayed indicating that a pause has been programmed.



# Repeat Play



## Repeat play of a chapter/track

Press once during playback of the chapter or track you want to repeat.

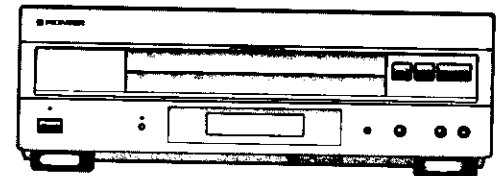

## Repeat play of a specified section.

Press at the beginning and end of the section you want to repeat.

## Repeat play of a title

Press twice.

- With DVDs, the title continues playing until the end, and then playback starts once more from the beginning of that title.
- With CDs and Video CDs, the entire disc is repeated
- With LDs, a single side is repeated.

## Repeat play of double-sided LDs

Press three times

- Both sides are repeated, starting on Side A.

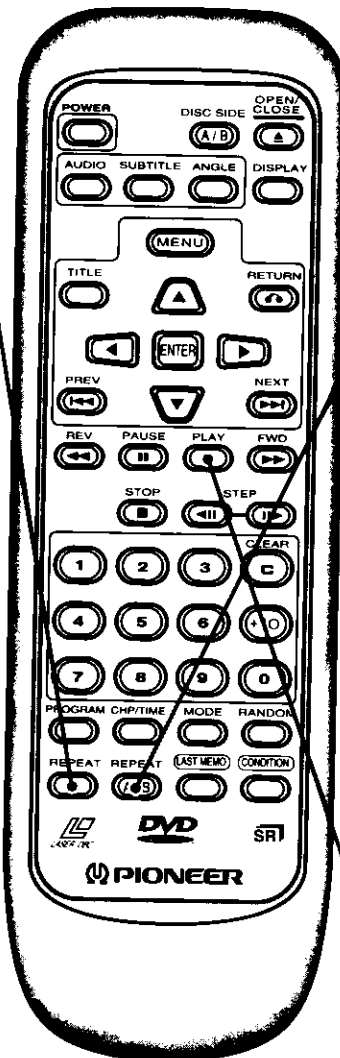

## Return to a specified location

① Press at the desired location.

② When you want to return to the selected location, press .

- Press to clear a specified location.



- Press to cancel Repeat play. The Repeat play mode is canceled, but playback continues.
- With DVDs, everything in the same title is repeated.
- During program play, press and the program is repeated.

### Notes

- ◆ With DVDs, Repeat play may not be possible with certain titles. In this case, the mark is displayed.
- ◆ During Video CD PBC play, repeat play is not possible. To perform Repeat play, start playback without displaying a menu (refer to page 18), and press .

DVD



# Still/Step Slow Playback

PLAY/PAUSE ►/|| button

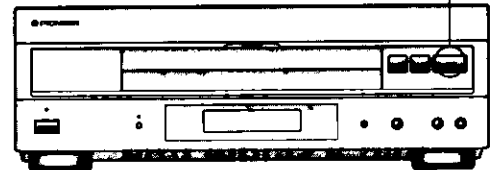

Detailed Operation

## Viewing one frame at a time with Step Playback

1 Press

2 Press the or button.

- : Each time you press it, you move ahead one frame.
- : Each time you press it, you move back one frame. (LDs)  
Each time you press it, you move back a little. (DVDs)

## Slow playback

During play, continue pressing the or button.

: Playback is slow.

During slow playback, you can adjust playback speed with the and buttons.

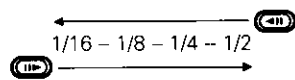

: Slow playback is in the reverse direction.



- To return to normal playback, press (or the PLAY/PAUSE ►/|| button on the player)

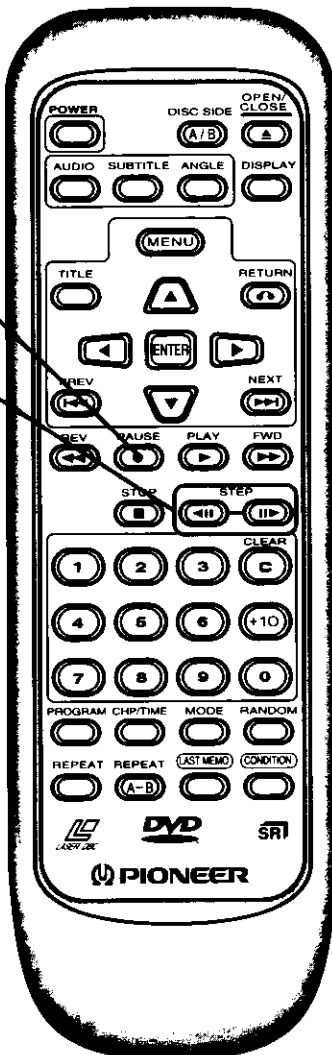

## Viewing a Still Frame

Press .

- Press the PLAY/PAUSE ►/|| button on the front of the player.
- With LDs or DVDs, if still images are unclear, refer to "Field" on page 32, and perform the necessary settings.

### Notes

- There is no sound when viewing still frames or when advancing one frame at a time.
- Pause may not be possible with certain discs. In this case, the mark is displayed.
- Slow playback may not be smooth with some Video CDs.
- With LDs, play automatically stops if still frame display continues for 20 minutes.

# Random Play



## With DVDs

### Random play of chapters within a single title

Press and then press .

- "RANDOM CHP" is displayed on the screen, and chapters within a single title are played in random order.

### Random play of titles

Press twice, and then press .

- "RANDOM TITLE" is indicated on the screen, and titles are played in random order.

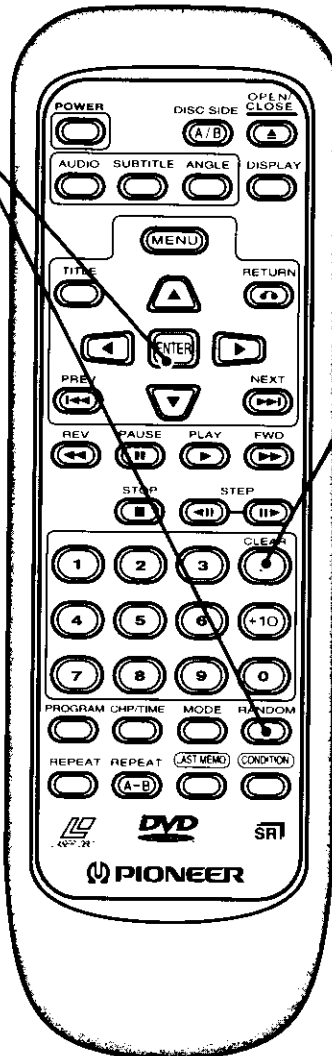
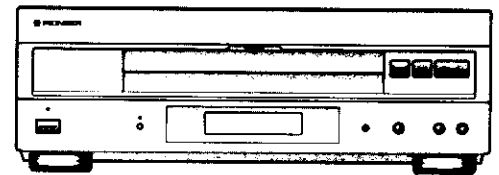

## Stopping Random play

Press .

- This returns you to normal playback of chapters/tracks in order from the chapter/track currently playing.

## With LDs

Press .

- "RANDOM" is indicated on the screen, and chapters are played in random order.

### For random play of side B on an LD:

- Press , and then press after side B has been selected.

## With CDs and Video CDs

Press .

- "RANDOM" is indicated on the screen, and tracks are played in random order.

### During random play:

- Press and the player selects and starts playing the next track.
- Press and the current track starts playing again from the beginning.

### Notes

- ◆ Random play is not possible with LDs not featuring chapters.
- ◆ With Video CDs, Random play is not possible during playback with the menu displayed (PBC playback). To perform Random play, start playback without displaying a menu (refer to page 18), and press .
- ◆ Random play of programmed chapters is not possible.
- ◆ With DVDs, random play is not possible with certain titles.
- ◆ Random play cannot be repeated.



## Setting

Multi-Aspect Setting for Wide Screen TV Software .....	26
Memorizing Settings for Often Viewed DVDs (Condition Memory) .....	27
Selecting Languages (Multi-Language) .....	28
Changing Audio Type .....	28
Selecting Subtitle Language (Multi-Language Subtitles) .....	29
Viewing from a Desired Camera Angle (Multi-Angle) .....	29
Viewing Information .....	30
Changing Picture and Sound Quality .....	31
Quick LD Side Changing(Quick Turn) .....	34
Selecting a Desired Background Color .....	34
Outline of GUI (Graphical User Interface) Operation .....	35



# Multi-Aspect Setting for Wide Screen TV Software

Certain DVDs feature image data recorded with the "squeeze" recording system for wide screen viewing. When watching this kind of DVD on a conventional TV, the picture may appear vertically squeezed. If this occurs, you can use the Multi-Aspect function to achieve a normal picture.

Setting is possible when a DVD is loaded.

1. Press **(MENU)** when the player is in the **STOP** mode.

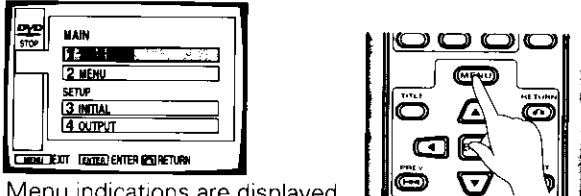

• Main Menu indications are displayed.

6. Select the desired mode (Pan & Scan, Letterbox, Wide) with **(▲)** **(▼)**.

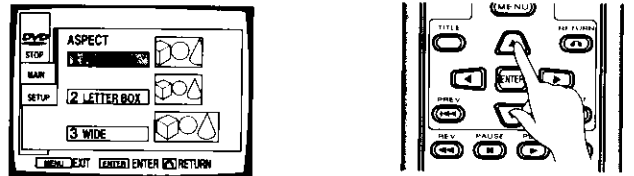

2. Select initial setting with **(▲)** **(▼)**.



7. Press **(ENTER)**.

• Switch to the desired screen.

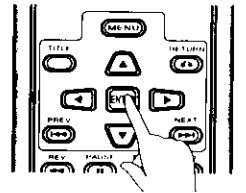

3. Press **(ENTER)**.

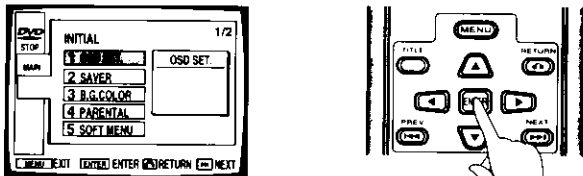

• Initial setting indications are displayed.

4. Select Multi Aspect with **(▲)** **(▼)**.

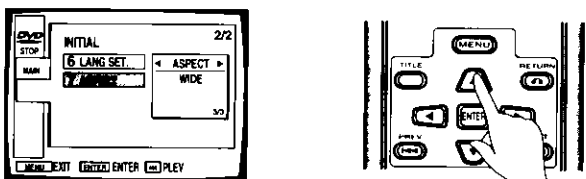

5. Press **(ENTER)**.

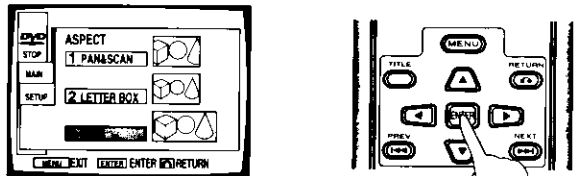

• Aspect indications are displayed.

With DVDs enabling switching between aspect ratios, select the appropriate one for your TV.

Disc	Aspect switching	Wide TV (16:9)	Regular TV (4:3)
16:9	Wide		
	Pan & Scan		
4:3	Letterbox		

Selecting  in the chart above assures correct aspect ratio for the TV used.

Whether or not aspect ratio can be changed depends on the disc. Confirm by referring to the disc's jacket.

With disc not enabling aspect ratio changing, make adjustments with the TV.

**Note**

◆ If there is a power outage or the power cord is disconnected while power to the player is ON, memorized settings are erased. When disconnecting the power cord, be sure to press POWER button on the main unit and the remote control until "OFF" is no longer indicated in the display. After that, press the POWER switch on the main unit to shutdown.

● The width-to-height ratio of conventional TVs is 4:3, while the width-to-height ratio of wide screen and Hi-Vision TVs is 16:9. This width-to-height ratio is called the aspect ratio.

# Memorizing Settings for Often Viewed DVDs (Condition Memory)

You can store settings for DVDs you often watch in memory. Settings remain in memory even if you remove the disc from the player, or switch power to the player OFF. If you load a disc that has its settings memorized, the Condition indicator lights. When you start playing the disc, the memorized settings are automatically recalled.

The Condition indicator in the display section lights. You can memorize details for the following five settings.

- Multi-Aspect (page 26)
- Multi-language (page 28)
- Multi-language subtitles (page 29)
- Cinema mode/Animation mode (page 31)
- Location (page 43)

## Press during Play.

"CONDITION" is indicated in the display.

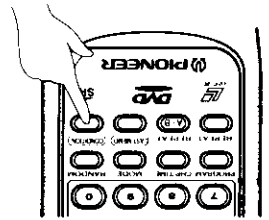

## When a memorized disc is loaded

"CONDITION" is indicated, and previous settings are displayed.

## Erasing memorized settings

Load a memorized disc, and during "CONDITION" is indicated, press . The recorded details for that disc are erased.



- Settings are stored in memory for use any time.
- You can store settings for up to 30 DVDs in memory. If you memorize settings for more than 30 DVDs, previously memorized settings are erased in order from the least recently memorized settings.
- To make changes to Aspect ratio, Cinema mode/Animation mode, subtitle language, and language settings, press  during playback.
- This player memorizes multi-language subtitles and multi-languages as languages not numbers. With DVDs that have multiple settings for the same language, playback starts from the first number.



◆ **Note** If there is a power outage or the power cord is disconnected while power to the player is ON, memorized settings are erased. When disconnecting the power cord, be sure to press POWER button on the main unit and the remote control until "OFF" is no longer indicated in the display. After that, press the POWER switch on the main unit to shutdown.

# Selecting Languages (Multi-Language)

Dolby Digital, PCM, and other audio data is recorded on DVDs in a number of languages, letting you choose the desired language.

1. Press  during playback.

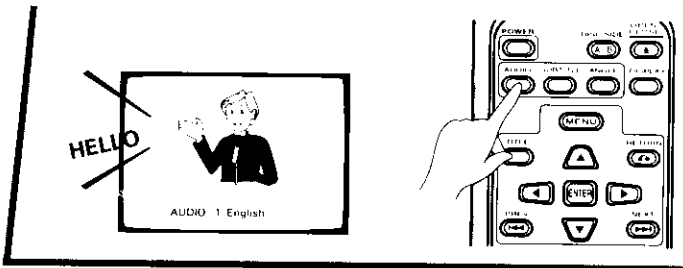

**Note**

- ◆ You cannot switch languages if there is only one language recorded on the disc.
- ◆ Language number and setting differ with each disc, so refer to the disc's instructions.
- ◆ Some titles may not enable switching between languages. If this happens, the  mark is displayed.

2. Press  to select the desired language.

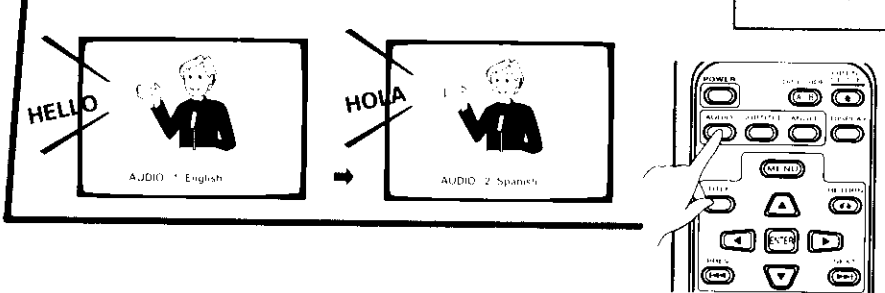

- Depending on the title, you can also make a selection using a menu. To do this, press the  button when indications are displayed to call up a menu, and select the desired title.



# Changing Audio Type

1. Press  during playback.

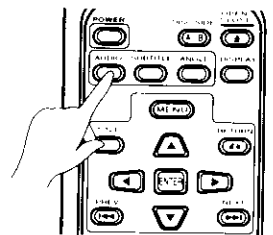
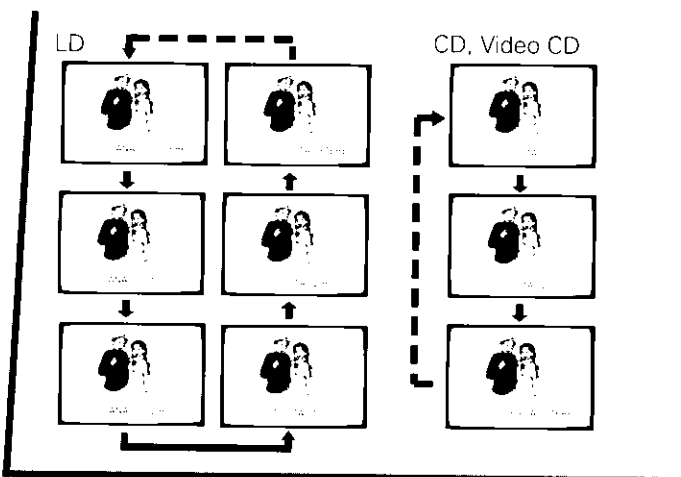

- Audio type changes each time you press the button.

**Notes**

- ◆ You cannot select digital audio if digital audio data is not recorded on the LD.
- ◆ You cannot switch audio type when using digital output (optical, coaxial) (DORF output).
- ◆ With LDs, switching to the CX System is possible with some discs. In this case, you can perform switching with this operation.

- With karaoke and other software, set the appropriate audio type for singing and accompaniment after referring to information on the disc jacket or accompanying material.

# Selecting Subtitle Language (Multi-Language Subtitles)

You can select a desired subtitle language with DVDs that have subtitle data in multiple languages recorded on them.

1. Press  during playback.

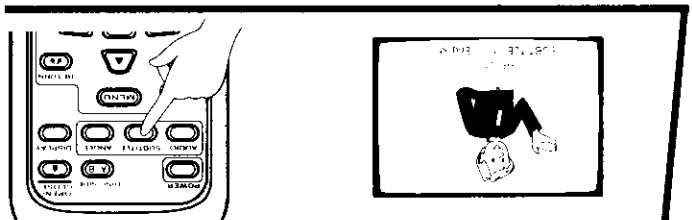

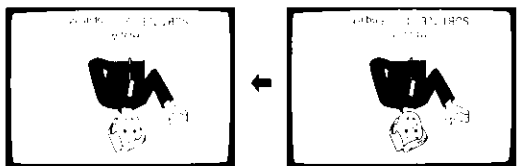

2. Press  to select the desired language.



### Notes

- ◆ You cannot switch subtitle languages with discs that do not have subtitle data recorded on them, or discs that feature subtitle data in only one language.
- ◆ Some titles may not enable switching between subtitle languages. If this happens, the  mark is displayed.



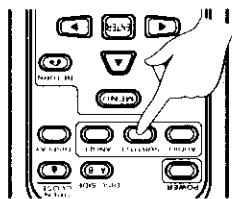

- To clear subtitles during playback, when there's a display press  after first pressing . You can also clear subtitles by selecting OFF in the subtitle menu display.
- If the basic subtitle is set to "OFF" in the initial setting menu, you can cancel subtitles.
- Depending on the title, you can also make a selection using a menu. To do this, press the  button when indications are displayed to call up a menu, and select the desired title.







# Viewing from a Desired Camera Angle (Multi-Angle)

With DVDs featuring recordings of images shot from different angles, you can choose a desired viewing angle.

## To confirm whether multi-angle information is recorded on a disc

The disc jacket bears the  mark. When a disc played on this player has sections that include multi-angle information, displays the  mark.

### Setting without displaying angle mark

1. Press  button.
2. Press the  button. The angle mark menu is displayed.
3. Press the  button. The initial setting menu is displayed.
5. Press the  button. Shows the screen menu.



- You can use the Multi-Angle function only with discs featuring recordings of images shot from different camera angles.
- During Multi-Angle playback, the Angle indicator on the player lights.
- Depending on the title, you can also make a selection using a menu. To do this, press the  button when indications are displayed to call up a menu, and select the desired title.

1. Press  during playback.

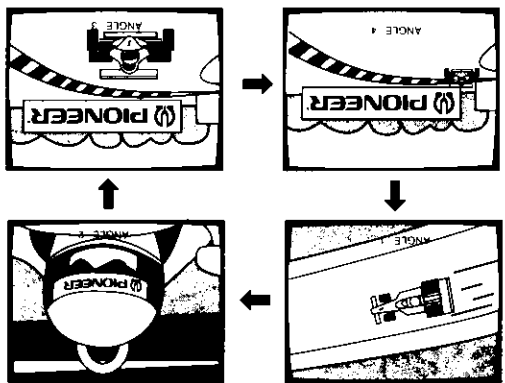

- The camera angle changes each time you press the button.
- You can also make your selection from a menu.

### Note

- ◆ Some titles may not enable switching between angles. If this happens, the  mark is displayed.

# Viewing Information

Press  during playback.

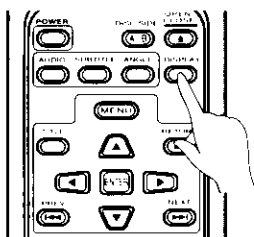

### Notes

- ◆ To prevent TV screen burn-in, the display automatically switches OFF after about 80 minutes.
- ◆ Not displayed with LDs that do not have a TOC (refer to page 55) or after playback of side B finishes. There is also no display if Quick Turn is switched ON.

- Each time you press , setting change as follows.
- If you press during the Stop mode, all the disc's information is displayed.

## < DVD >

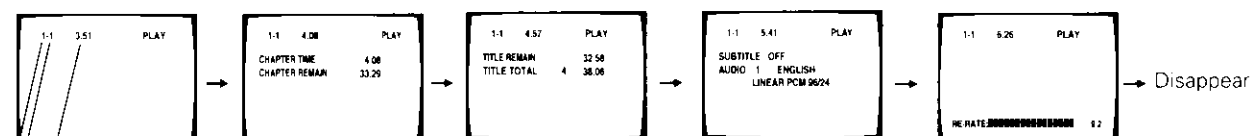

Elapsed time  
Chapter number  
Title number

Chapter time:  
Elapsed time of the chapter currently playing  
Chapter remain:  
Remaining time of the chapter currently playing

Title remain:  
Remaining time of the title currently playing  
Title total:  
Total chapter number and total play time of the title currently playing

Subtitles:  
Subtitle information  
Audio:  
Audio information

Play rate:  
Level meter showing play rate

## < LD >

CLV: Extended play disc

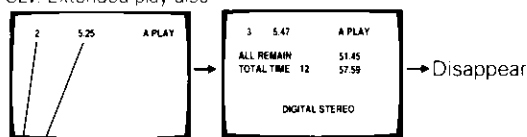

Elapsed time  
Chapter number

All remain:  
Remaining time from the current location on the disc playing  
Total time:  
Total chapter number and total disc play time

CAV: Standard play disc

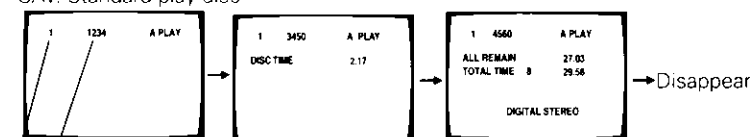

Frame number  
Chapter number

Disc time:  
Elapsed time from start of disc

All remain:  
Remaining time from the current location on the disc playing  
Total time:  
Total chapter number and total disc play time

## < CD >

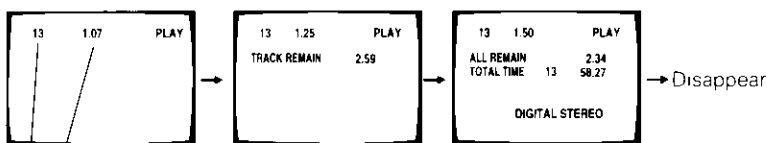

Elapsed time  
Track number

Track remain:  
Remaining time of the track currently playing

All remain:  
Remaining time from the current location on the disc playing  
Total time:  
Total track number and total disc play time

## < Video CD >

(PBC off)

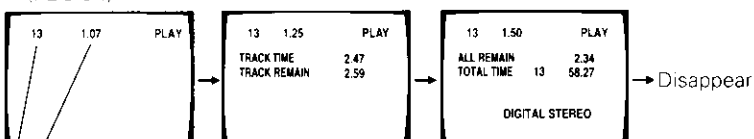

Elapsed time  
Track number

Track time:  
Elapsed time of the track currently playing  
Track remain:  
Remaining time of the track currently playing

All remain:  
Remaining time from the current location on the disc playing  
Total time:  
Total track number and total disc play time

(PBC on)

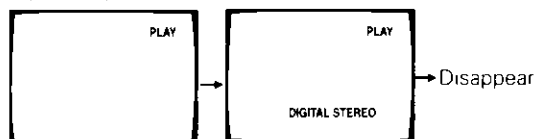

# Changing Picture and Sound Quality



Each time you press , settings change as follows.

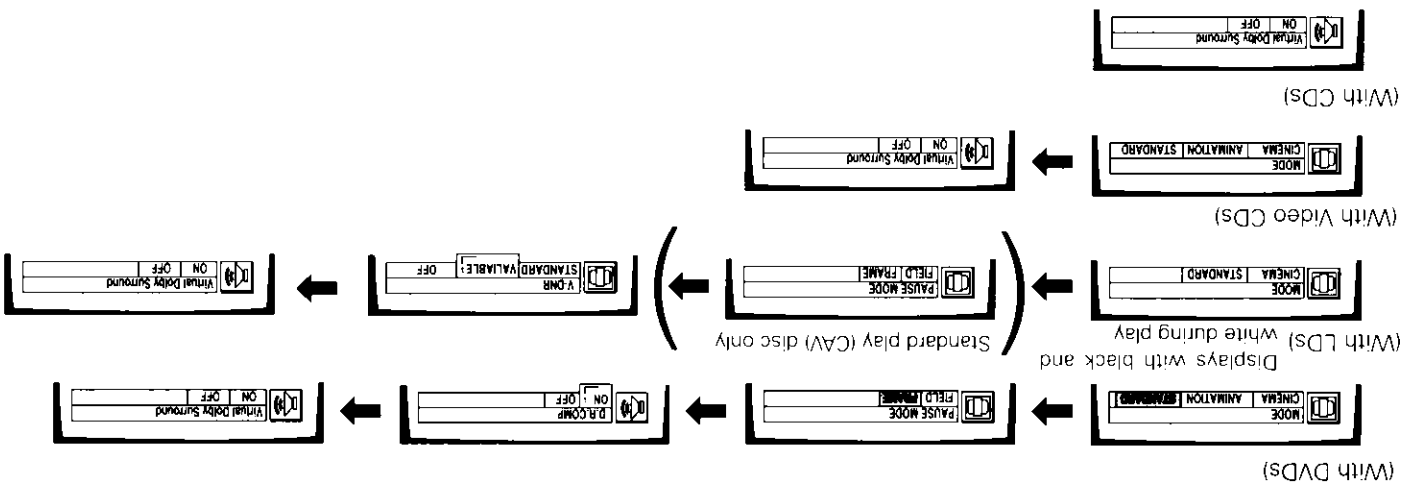

1. Press  during play and select

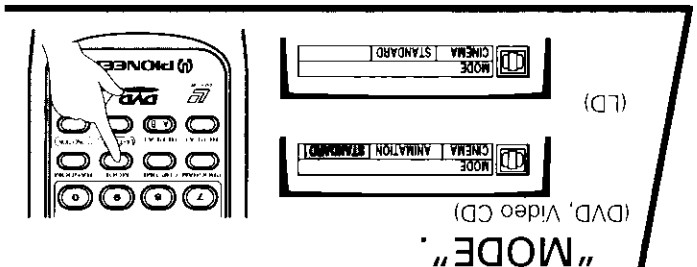

2. Select the desired mode with the  and  buttons.

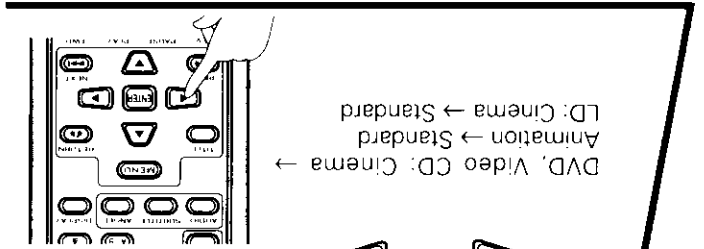

**Cinema:** Picture quality: Provides clear picture with clear black and white definition.  
**Animation:** Picture quality: Provides beautiful images with bright, clear colors.  
**Standard:** Picture quality: Returns you to standard picture and function settings.

- You cannot use the Animation mode for the video part of LDs and DVDs.
- You can use the same setting for DVD video part as for LDs.

**Note** ◆ Picture quality may be poor depending on the software and the TV used. In this case, select the Standard mode.

## Changing Picture and Sound Quality

### Changing Still Frame conditions (PAUSE MODE)

DVD



During Still Frame play, switch to Field if the picture is out of focus.

1. During play, press , and select PAUSE MODE.

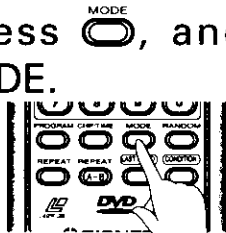
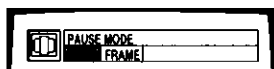

2. Select Field or Frame with and buttons.

The setting changes each time you press a button.

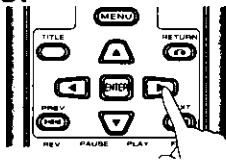

With LDs, this functions only during play of standard (CAV) discs. With long-play (CLV) discs, still picture becomes field, and cannot be switched.

### Changing sound quality (D.R.COMP)

DVD

D.R.COMP stands for Dynamic Range Compression. On the DVDs, sound has a wide dynamic range. Use D.R.COMP is sounds such as dialog are hard to hear on your stereo system or TV speakers.

1. Press during play, and select D.R.COMP.

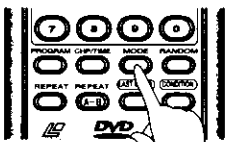
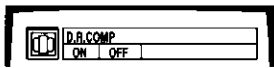

2. Switch ON or OFF with the and buttons.

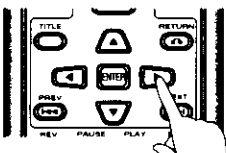

3. If you select ON, press .

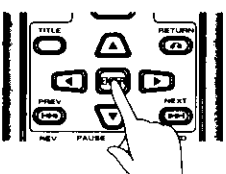
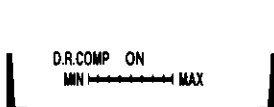

4. Adjust the degree of change with the and buttons.

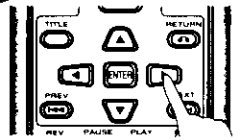
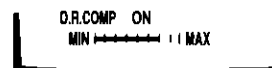

5. Press .

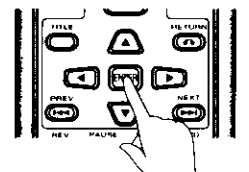

or Pressing the or button at step 4 switches between ON and OFF.



## Switches to a more spacious sound (Virtual Dolby Surround)

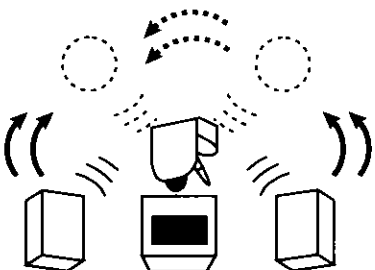

SRS Labs, Inc.'s Trusurround system (Trusurround) has been adopted as virtual technology. Trusurround is a trademark of SRS Labs, Inc. in the United States and selected foreign countries. Trusurround is incorporated under license from SRS Labs, Inc. Permission for use of Trusurround technology has been registered through SRS Labs, Inc.

1. Press **⏻** during play, and select Virtual Dolby Surround.

2. Select ON with the **▶** and **◀** button.

## Adjusting brightness (luminance) and color (V-DNR: Variable Digital Noise Reduction)

When playing an LD or CD, this function reduces noise and color smearing. The player lets you adjust luminance (Y) and color (C) separately.

1. Press **⏻** twice during play, and select V-DNR.

2. Select Standard, Variable or OFF with the **▶** and **◀** buttons.

3. When you have selected Variable, press **ENTER**.

Switches to Y (Luminance) and C (Color) adjustment display.

4. Select Y or C with the **▽** and **▲** buttons.

Adjust the degree of effect with the **▶** and **◀** buttons.

The flashing side can be adjusted.

5. Press **ENTER**.

## Quick LD Side Changing (Quick Turn)

This function shortens the time required to change from A to the B side, or from the B to the A side when playing an LD.

1. Press **(MENU)** when play has stopped.

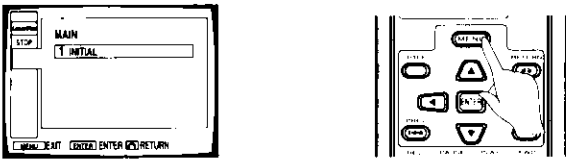

2. Press **(ENTER)**.



3. Select Quick Turn with the **(▲)** and **(▼)** buttons.

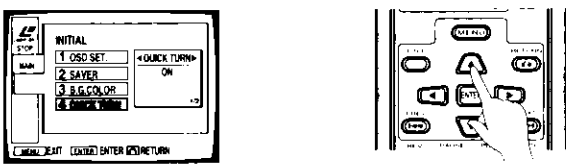

4. Press **(ENTER)**.

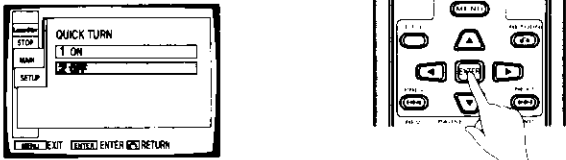

Displays the selection menu of Quick Turn.

5. Select ON with the **(▲)** and **(▼)** buttons and press **(ENTER)**.

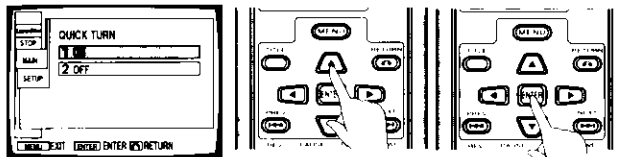

Quick Turn is set to ON.

### Note

When Quick Turn is ON, on-screen display of remaining and total play time cannot be used.

## Selecting a Desired Background Color

You can select a color for menu displays and the screen when the player is not playing. You can set a color each for DVDs, LDs, and CDs (Video CDs).

1. Press **(MENU)** when the player is not playing.



(With a DVD)

2. With the **(▲)** **(▼)** buttons, select "INITIAL" and press **(ENTER)**.



3. Select "B.G. COLOR" with the **(▲)** **(▼)** buttons, and press **(ENTER)**.



4. Select the desired color with the **(▲)** **(▼)** buttons, and adjust the color with the **(◀)** **(▶)** buttons.

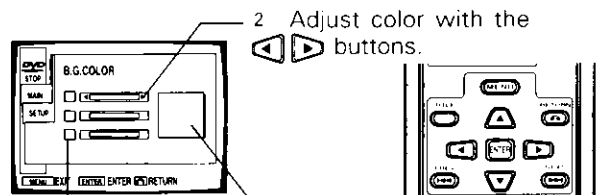

1 Select a color with the **(▲)** **(▼)** buttons.

2 Adjust color with the **(◀)** **(▶)** buttons.

Changes to the selected color.

5. Press the **(ENTER)** button.



# Outline of GUI (Graphical User Interface) Operation

DVD

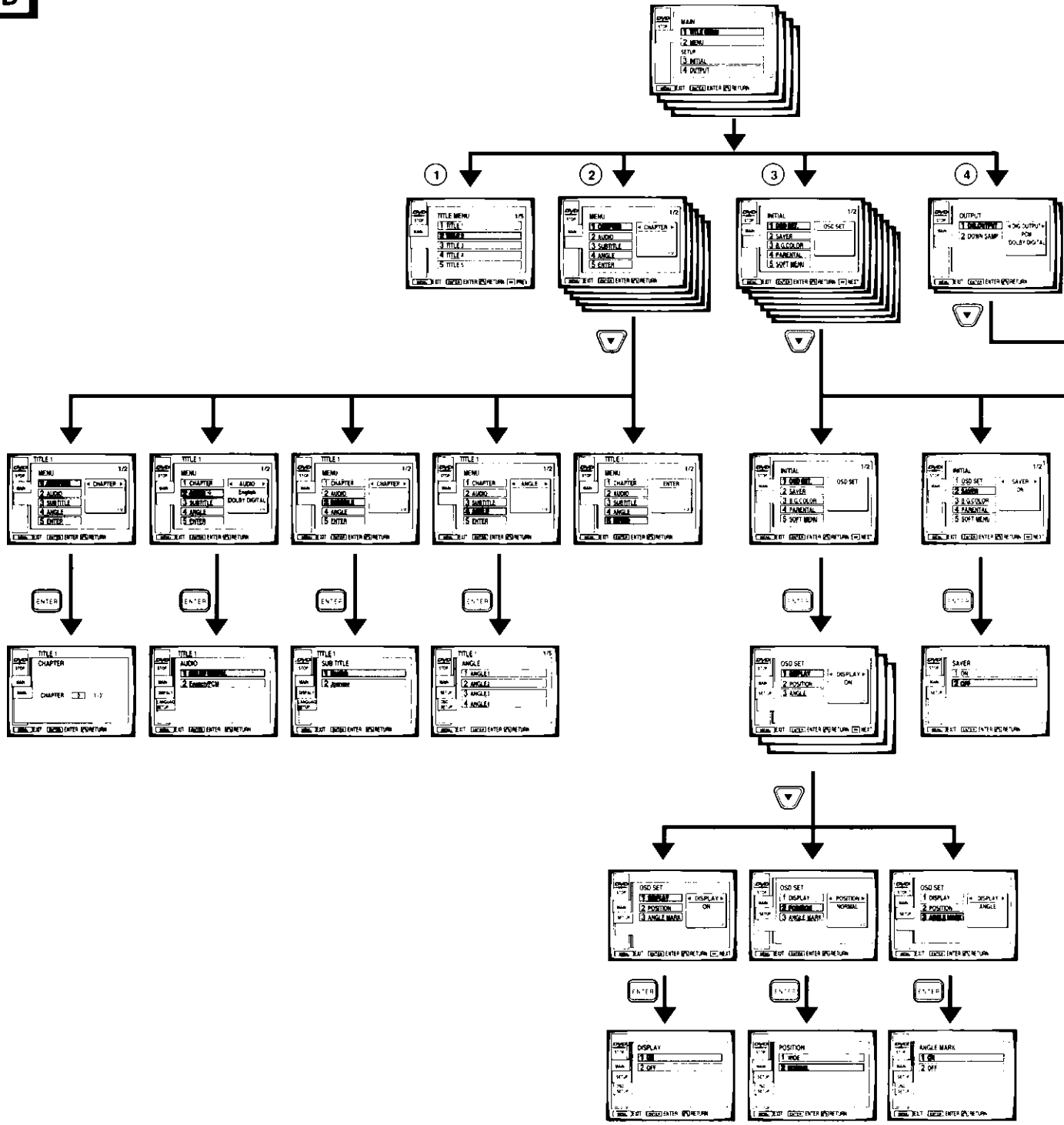

Outline of GUI (Graphical User Interface) Operation

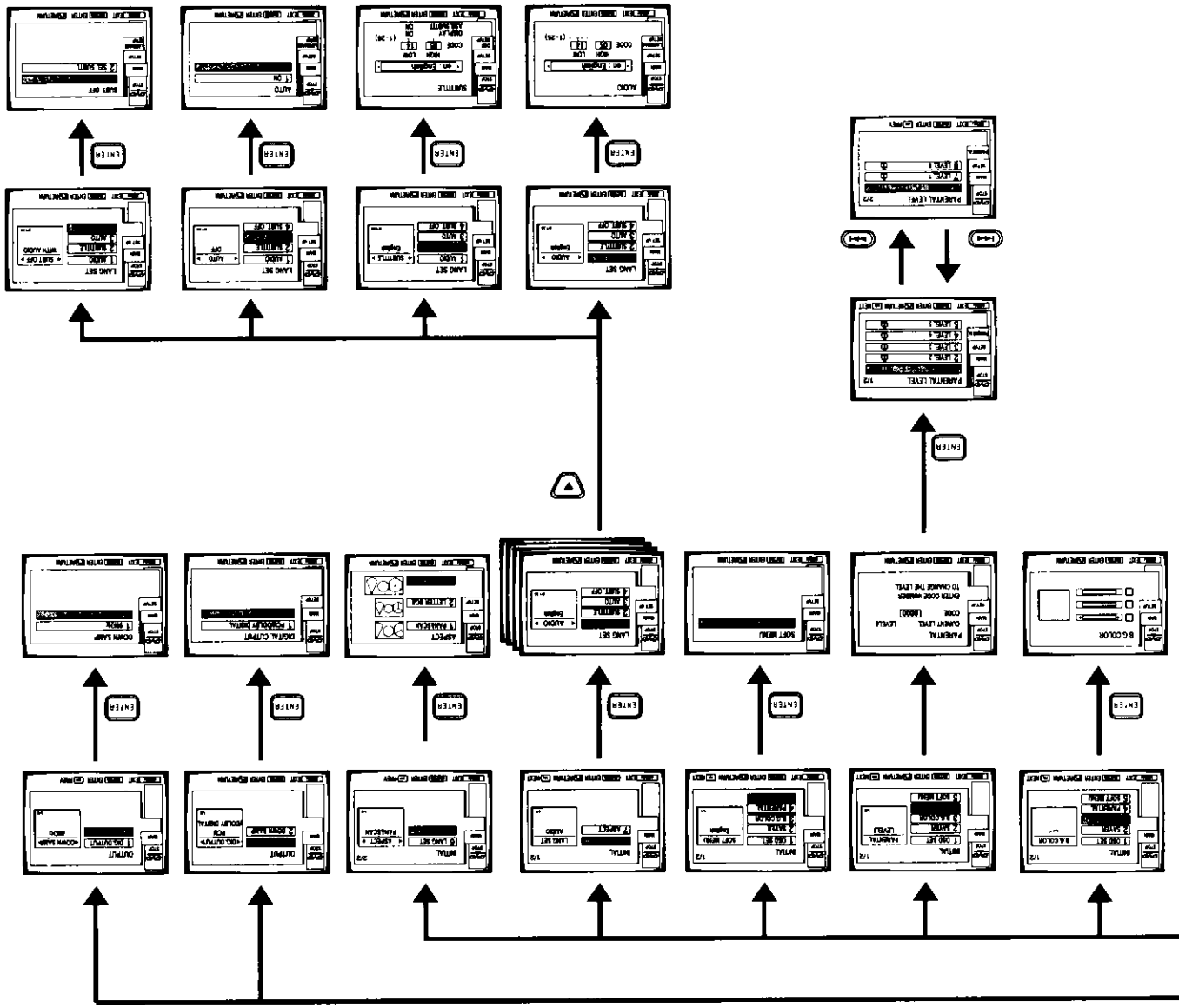

Outline of GUI (Graphical User Interface) Operation



Outline of GUI (Graphical User Interface) Operation

CD, Video CD

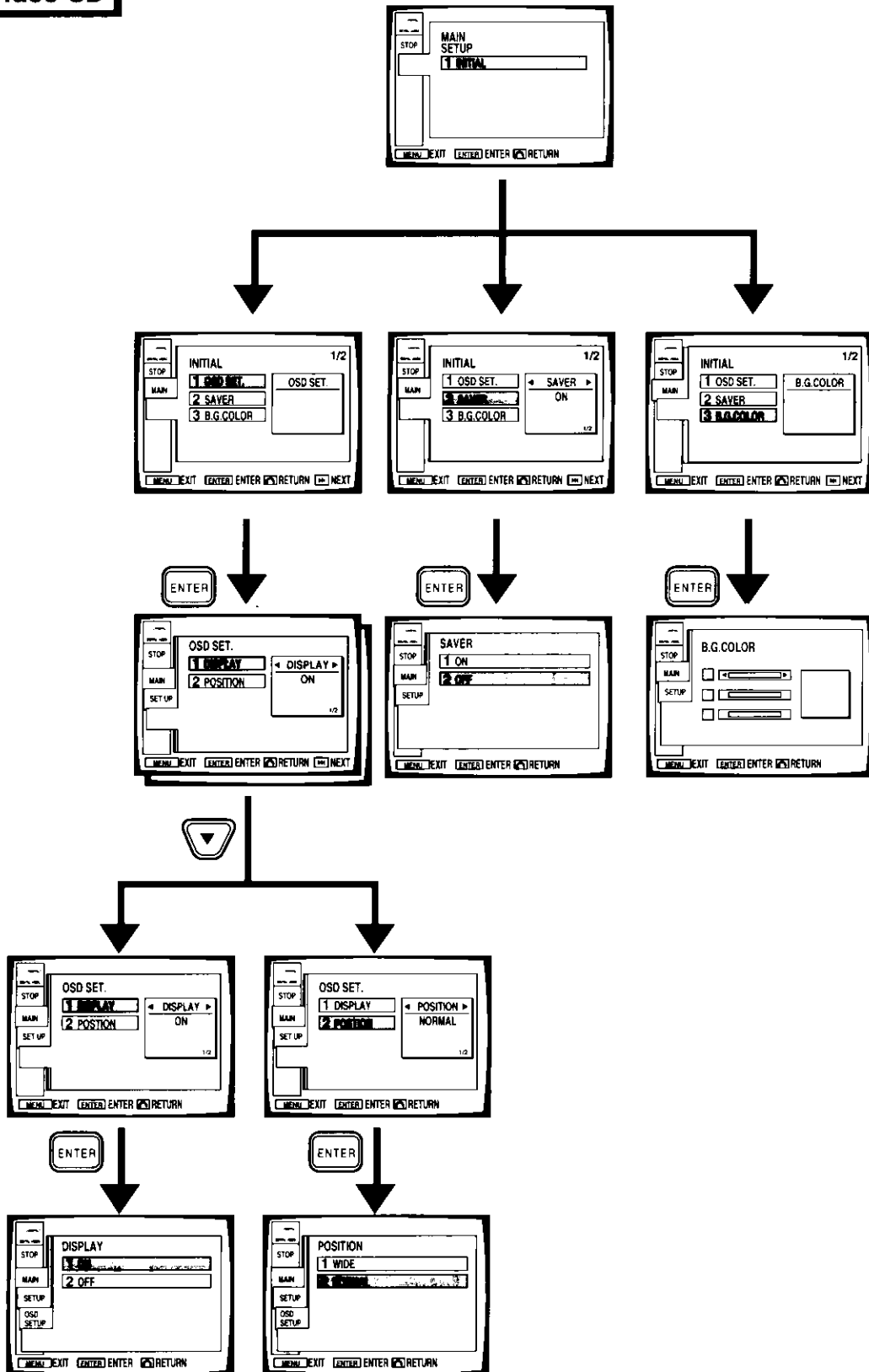

# Button operation within each menu

Button name

Button shape

Operation

MENU button



To leave the menu screen (settings are

RETURN button



To return one menu screen back (Set up operation is completed. However, search cannot be performed.)

Digit buttons



Selection and conclusion (In the set up menu, some items only operate for selection.)

Selection



ENTER button



Setting and implementation (playback mode is engaged after title or chapter change)

To go to previous menu screen



NEXT button



To go to next menu screen

To go to menus (setting selected before moving to a new menu will be invalidated)



AUDIO button

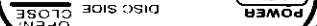

SUBTITLE button



ANGLE button



MENU button



ENTER button



RETURN button



PREVIOUS button



DIRECTION button



NEXT button



CHP/TIME button

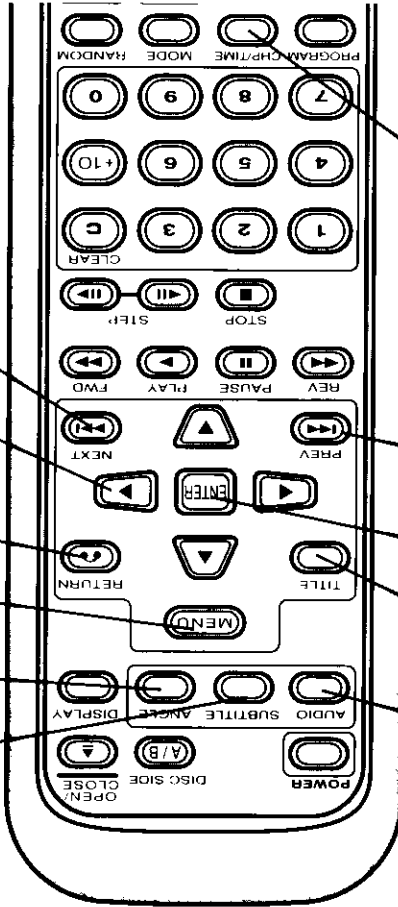

Outline of GUI (Graphical User Interface) operation

Examples of screen indicators and operation

Ex.1: Display content within menus/Button operation (Ex: DVDs)

Title name(Only displayed when information is include on disc)

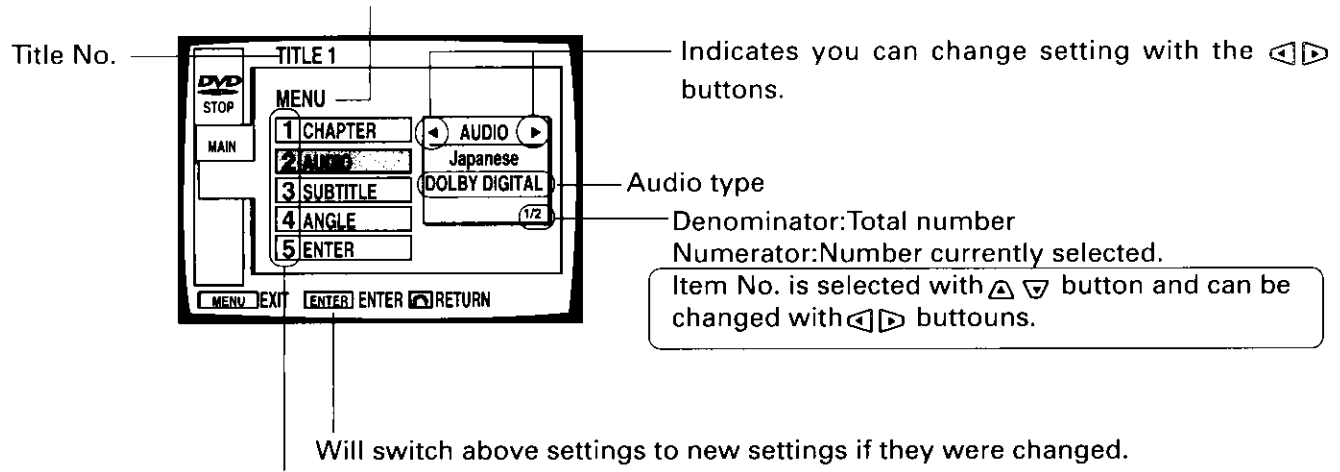

Selection item No.

When selection is made by pressing a **digit button** or the ▲ or ▼ button, and then pressing the **ENTER button**, the selection screens for the various set-up items will be displayed. Selecting 5[ENTER], however, will select the new setting changes and close the screen.

Ex.2: Display content within set up menus/Button operation (Ex: DVDs)

Current settings

Item numbers can be selected with the ▲▼ buttons and settings changed with the ◀▶ buttons.

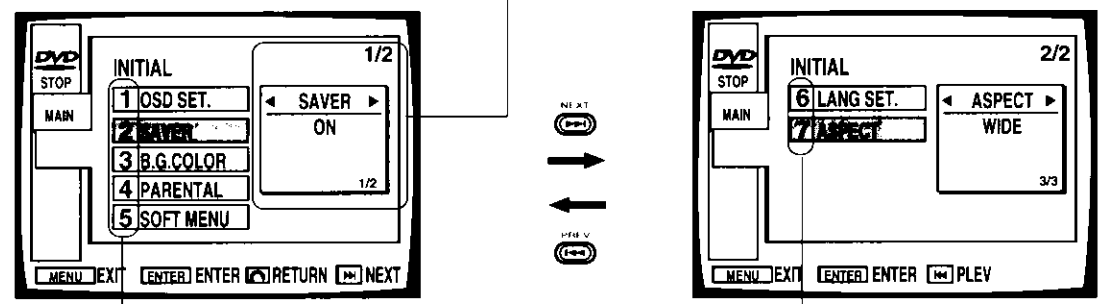

Selection can also be made with the digit buttons.



## About the main menu (EX: DVDS)

Outline of GUI (Graphical User Interface) Operation

The main menu is the menu used for selecting the Title menu screen, Menu screen and Set up screen.

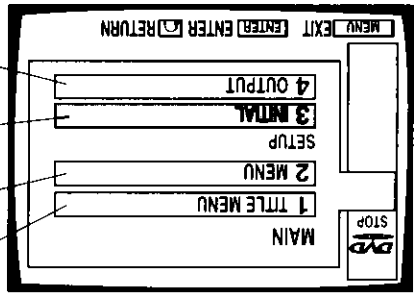

- In the Title menu screen:** Titles can be selected and played back. (Title search)
- In the Menu screen:** Chapters (songs), subtitles, audio and angles within a title can be selected.
- In the initial setting menu:** You can perform on-screen setting of each function.
- In the output setting menu:** You can select the audio signal or video signal output from the player's digital output jack.

## About the title menu

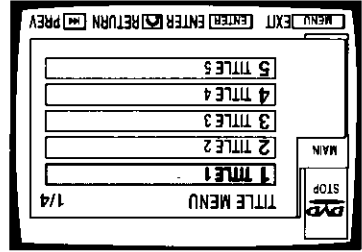

Titles can be selected and played back. This selection screen is the same as the one in "Direct Search with Title Numbers" on page 19.

## Menu screen contents

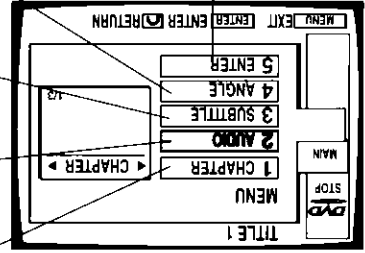

- In the Chapter screen:** One chapter (song) within a title can be selected and played back.  
To go to the Chapter screen
  - In the Audio screen:** Audio contents can be selected on discs that include more than one audio language or audio type.  
To go to the Audio screen
  - In the Subtitle screen:** Subtitle contents can be selected on discs that include subtitle information.  
To go to the Subtitle screen
  - In the Angle screen:** The scene angle that you want can be selected on discs that include scenes that have been filmed from various angles.  
To go to the Angle screen
- Completes the setting of changes to the above items.

## Outline of GUI (Graphical User Interface) Operation

### Initial setting menu

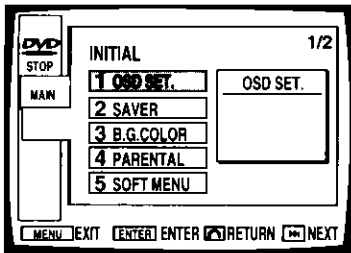

Use to change a wide range of settings. On the next page, the details of each item are provided.

### Output setting menu

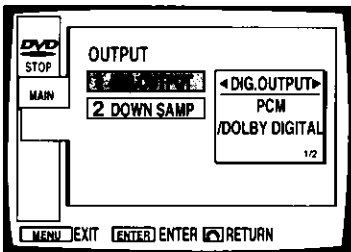

Use when you have selected audio output or video output from the player via the digital output jack. Change the setting to match your amplifier or monitor.

On the next page, the details of each item are provided.



### Settings Chart



Class	Initial setting		Language setting	
	Item	Details	Initial settings (factory settings)	Settings status
OSD setting	Display	Switches between display of operation indications (Play, Stop etc.) (ON), and no display of indications (OFF).	ON	OFF
	Position	When watching regular software on a wide TV, operation indications may be displayed outside the area of the screen, so you can't see them. Changing the on-screen location of the indications lets you see them even when watching a wide TV.	Normal When using a regular (4:3) TV.	Wide When using a wide TV (not compatible with menu display)
	Angle mark	When displayed to clearly indicate when the scene playing has various recorded angles.	ON	OFF
	Saver	Leaving a still image on screen for a prolonged period can result in screen "burn". This player features a screen saver function that prevents screen indications. It is recommended to leave this function ON.	ON	OFF
	Background color	Lets you select background color for menus and for screen color when no software is playing. You can set R (red), G (green), and B (blue) independently. Setting for each color is possible in 21 steps.	Blue	Switchable
	Parental control	You can use this handy function if the disc features recorded parental lock coding. With parental lock discs, this function works by skipping violent or other scenes you don't want your children to see. For details, read the disc's instructions. Once the secret number has been set, the restricted viewing level remains the same until the number is reset. Try not to forget the secret number. If you do, you must return to the initial settings. (see page 44)	Level 8	Switchable between 1~8
	Software menu	This lets you select a desired language for menus on discs that have them in multiple languages.	English	Selection possible depend on the disc
	Quick Turn	This shortens the time required to change from A to the B side, or from the B to the A side when playing an LD. If you use this function, display of remaining and total time are not possible.	ON	OFF
Language setting	Audio	This lets you select and set the usual language for movies in the same way as for subtitles. Even if you change the language during play, or change discs, the language changes to the one set.	English	Select one from 136 languages. (See how to set the language on the next page.)
	Subtitle	This lets you select and set the usual language for subtitles. Even if you change the subtitle language during play, or change discs, the subtitle language changes to the one set.	English	Select one from 136 languages. (See how to set the language on the next page.)
	Auto	This sets basic language and basic subtitle language to the same language beforehand. When the basic language and basic subtitle language are not identical, if you switch "DISPLAY" OFF and "ASSIST" ON in the subtitle menu, it's the same as switching Auto OFF. With Auto on, the original language and subtitle language are automatically selected. When Language Selection may not operate in this way with certain discs. You can select a language (see page 28) and select a subtitle language (see page 29) part way through a movie. OFF Subtitle and dialog languages are those selected.	ON	OFF
	Subtitle OFF	Even when subtitles are switched OFF, they may still appear, depending on the disc. Language link: The language becomes the one you selected. Subtitle selection: Subtitles are in the selected language.	Subtitle selection	Language link
	Class	Item	Details	Initial settings (factory settings)



## Outline of GUI (Graphical User Interface) Operation

Class	Item	Details	Settings status		
			Initial settings (factory settings)		
	<b>Aspect</b>	When watching wide mode software, this lets you adjust aspect ratio to suit your TV.	<b>Wide</b>	<b>Pan &amp; Scan</b>	<b>Letterbox</b>
<b>Output setting</b>	<b>Digital output</b>	You can switch between audio output from the player's digital output jack or the digital coaxial PCM/DIG jack. Dolby Digital (sound system used at cinemas etc.) and Linear PCM (the same digital signal as CDs) are the two standards for DVDs.	<b>PCM/DOLBY DIGITAL</b> Automatically selects between Dolby Digital and linear PCM to match the audio signal. This is when using an amp with a Dolby Digital (AC-3) decoder.	<b>PCM</b> Dolby Digital and linear PCM signals are output in line with the linear PCM standard. This is when using a regular amp or Dolby Pro Logic amp.	
	<b>Down sampling</b>	<p><b>96 kHz:</b> With PCM audio sources that have a sampling frequency of 96 kHz, this assures high sound quality. With audio sources that have a sampling frequency of 48 kHz, play is performed with sampling frequency unchanged at 48 kHz.</p> <p><b>48 kHz:</b> During play, this compresses sampling frequency of 96 kHz discs to 48 kHz. 48 kHz discs are played as they are at a sampling frequency of 48 kHz.</p> <ul style="list-style-type: none"> <li>You can select the sampling frequency to match that of the audio signal recorded on a disc. Simultaneous switching between Analog output/Digital output is performed to match your selected sampling frequency.</li> <li>Some DVD format discs feature copy protect. With this kind of disc, when a sampling frequency of 96kHz is selected, no signal is output from the digital output. If you want to play this type of disc with digital output, select a sampling frequency of 48kHz from the menu.</li> </ul>	<b>96 kHz</b>	<b>48 kHz</b>	

**To return to the initial settings if they have been changed since you purchased the player, perform the following procedures.**

If power to the player is ON, switch it OFF. While power is OFF, press the  button while pressing the  button.



# Setting the Basic Language and Subtitle Language



## Basic language

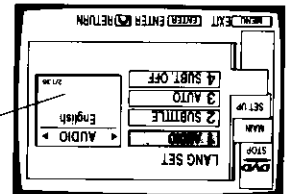

Change in order with the and buttons on the remote control.

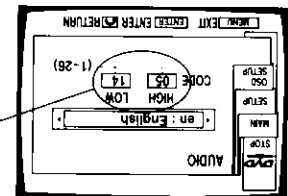

With the remote control number buttons, input the appropriate upper and lower language code input numbers as shown in the chart below.

## Basic subtitle language

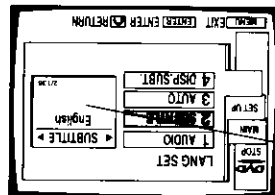

Press the remote control and buttons to make it flash, and then you can switch indication display ON or OFF with the and buttons. A subtitle function for the hard of hearing.

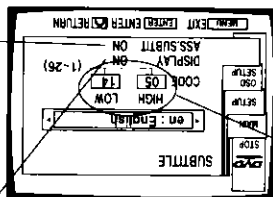

## Language code chart

Language	Language code	Input code (upper)	Input code (lower)
Japanese	ja	10	01
English	en	05	14
French	fr	06	18
German	de	04	05
Italian	it	05	19
Spanish	es	09	20
Dutch	nl	14	12
Russian	ru	18	21
Chinese	zh	26	08
Korean	ko	11	15
Greek	el	05	12
Afar	aa	01	01
Abkhazian	ab	01	02
Afrikaans	af	01	06
Amharic	am	01	13
Arabic	ar	01	18
Assamese	as	01	19
Aymara	ay	01	25
Azerbaijani	az	01	26
Bashkir	ba	02	01
Belorussian	be	02	05

## Outline of GUI (Graphical User Interface) Operation

Language	Language code	Input code (upper)	Input code (lower)
Bulgarian	bg	02	07
Bihari	bh	02	08
Bislama	bi	02	09
Bengali, Bangla	bn	02	14
Tibetan	bo	02	15
Breton	br	02	18
Catalan	ca	03	01
Corisian	co	03	15
Czech	cs	03	19
Welsh	cy	03	25
Danish	da	04	01
Bhutani	dz	04	26
Esperanto	eo	05	15
Estonian	et	05	20
Basque	eu	05	21
Persian	fa	06	01
Finnish	fi	06	09
Fiji	fj	06	10
Faroese	fo	06	15
Frisian	fy	06	25
Irish	ga	07	01

## Outline of GUI (Graphical User Interface) Operation

Language	Language code	Input code (upper)	Input code (lower)
Scottish Gaelic	gd	07	04
Galician	gl	07	12
Guarani	gn	07	14
Gujarati	gu	07	21
Hausa	ha	08	01
Hindi	hi	08	09
Croatian	hr	08	18
Hungarian	hu	08	21
Armenian	hy	08	25
Interlingua	ia	09	01
Interlingue	ie	09	05
Inupiak	ik	09	11
Indonesian	in	09	14
Icelandic	is	09	19
Hebrew	iw	09	23
Yiddish	ji	10	09
Javanese	jw	10	23
Georgian	ka	11	01
Kazakh	kk	11	11
Greenlandic	kl	11	12
Cambodian	km	11	13
Kannada	kn	11	14
Kashmiri	ks	11	19
Kurdish	ku	11	21
Kirghiz	ky	11	25
Latin	la	12	01
Lingala	ln	12	14
Laotian	lo	12	15
Lithuanian	lt	12	20
Latvian, Lettish	lv	12	22
Malagasy	mg	13	07
Maori	mi	13	09
Macedonian	mk	13	11
Malayalam	ml	13	12
Mongolian	mn	13	14
Moldavian	mo	13	15
Marathi	mr	13	18
Malay	ms	13	19
Maltese	mt	13	20
Burmese	my	13	25
Nauru	na	14	01
Nepali	ne	14	05
Norwegian	no	14	15
Occitan	oc	15	03
(Afan) Oromo	om	15	13
Oriya	or	15	18
Panjabi	pa	16	01

Language	Language code	Input code (upper)	Input code (lower)
Polish	pl	16	12
Pashto, Pushto	ps	16	19
Portuguese	pt	16	20
Quechua	qu	17	21
Rhaeto-Romance	rm	18	13
Kirundi	rn	18	14
Rumanian	ro	18	15
Kinyarwanda	rw	18	23
Sanskrit	sa	19	01
Sindhi	sd	19	04
Sango	sg	19	07
Serbo-Croatian	sh	19	08
Singhalese	si	19	09
Slovak	sk	19	11
Slovenian	sl	19	12
Samoan	sm	19	13
Shona	sn	19	14
Somali	so	19	15
Albanian	sq	19	17
Serbian	sr	19	18
Siswati	ss	19	19
Sesotho	st	19	20
Sundanese	su	19	21
Swedish	sv	19	22
Swahili	sw	19	23
Tamil	ta	20	01
Telugu	te	20	05
Tajik	tg	20	07
Thai	th	20	08
Tigrinya	ti	20	09
Turkmen	tk	20	11
Tagalog	tl	20	12
Setswana	tn	20	14
Tongan	to	20	15
Turkish	tr	20	18
Tsonga	ts	20	19
Tartar	tt	20	20
Twi	tw	20	23
Ukrainian	uk	21	11
Urdu	ur	21	18
Uzbek	uz	21	26
Vietnamese	vi	22	09
Volapük	vo	22	15
Wolof	wo	23	15
Xhosa	xh	24	08
Yoruba	yo	25	15
Zulu	zu	26	21

# Set Up

## Other Information

Connecting the Player	
Connection example 1. To a TV with video input.....	48
Connection example 2. To an amp with Dolby Digital (AC-3) inputs .....	49
Connection example 3. AV amp.....	50
<b>Names and Functions</b>	
Front panel.....	51
Rear panel.....	51
Display window.....	52
Remote control.....	53
<b>Troubleshooting</b>	
.....	54
Terms.....	55
Specifications.....	57

Set-Up  
Other Information

# Connecting the Player

## Precautions when connecting the player

Some discs will be copy protected at the direction of the copyright owners. For best playback, make sure the DVD player is connected either directly to the television or through an A/V selector and not through a VCR.

### Input/output plug (pin cable)

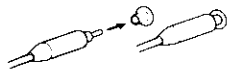

Match jack color (white, red, yellow) and plug color.

### Optical cable

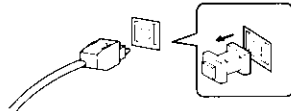

### S video cable



### Connection example 1.

To a TV with video input

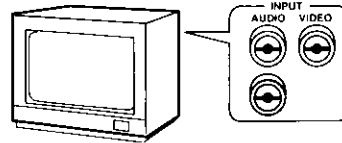

If your TV has a video input, and it is available for use, this is the easiest way to hook up the player.

Please also refer to the manual for the TV (monitor TV) that you are making connection to.

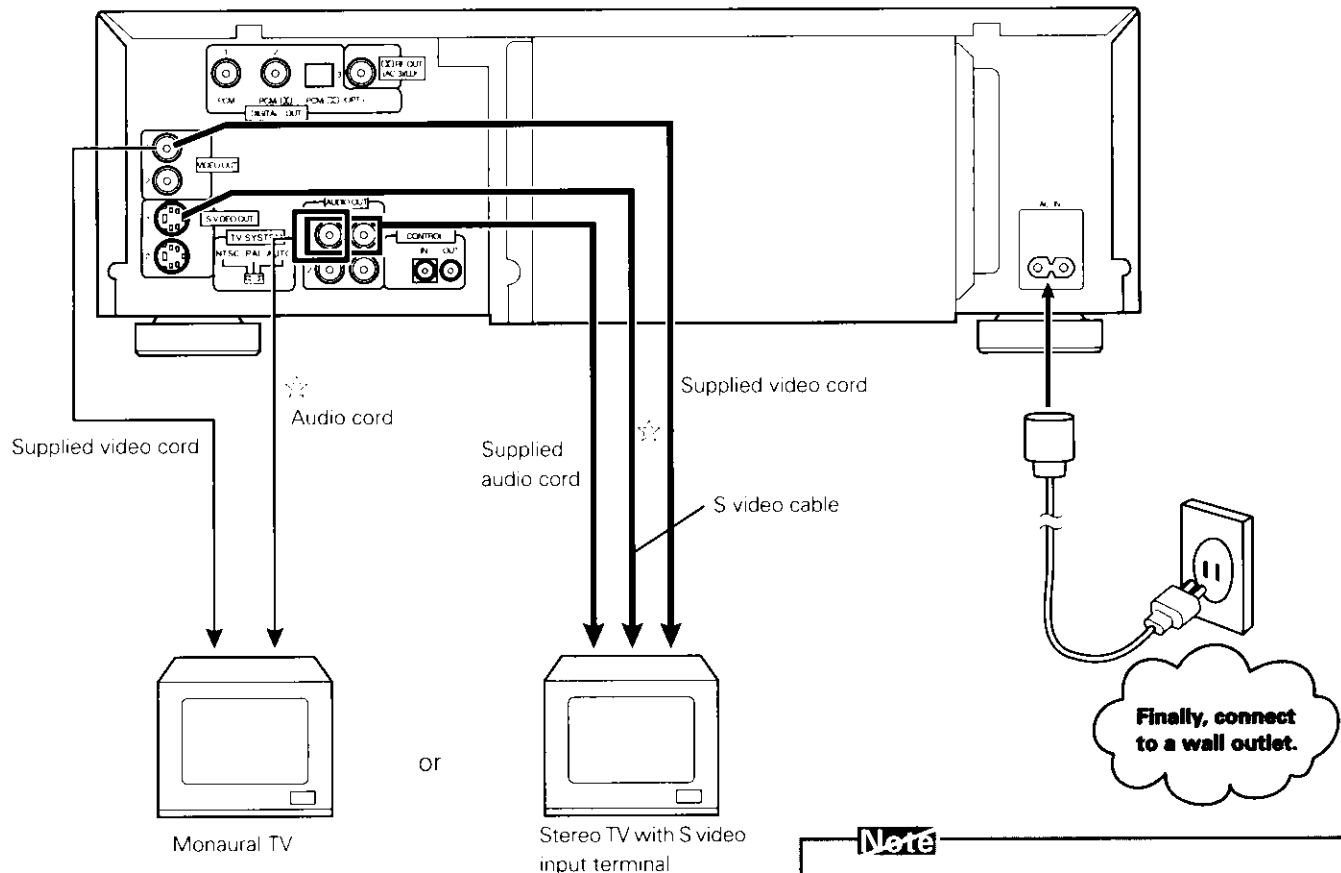

### Note

☆ indicates the use of separately sold cords.



## Connection example 2. To an amp with Dolby Digital (AC-3) input

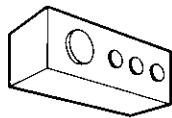

AV amplifier or AV receiver enabling Dolby Digital (AC-3) digital input and RF input in the same function

- Connect this player's digital output PCM/DIGITAL jack to the Dolby Digital input jack of an amp with Dolby Digital capability. Use coaxial digital output or optical digital output depending on the amp's inputs.
- Connect this player's DIGITAL RF output (for LD) jack to the Dolby Digital (AC-3) RF input jack on an amplifier or a receiver with Dolby Digital capability.
- Digital output of LD analog audio is not possible, so also connect this player's audio output jack and the amp audio input jack. **PCM/DIGITAL**

**When using an optical cable, perform the settings in the "Digital output" section on page 44, making sure to select PCM/DIGITAL.**

You can enjoy Dolby Digital sound by connecting either PCM/DIGITAL optical jack or coaxial jack.

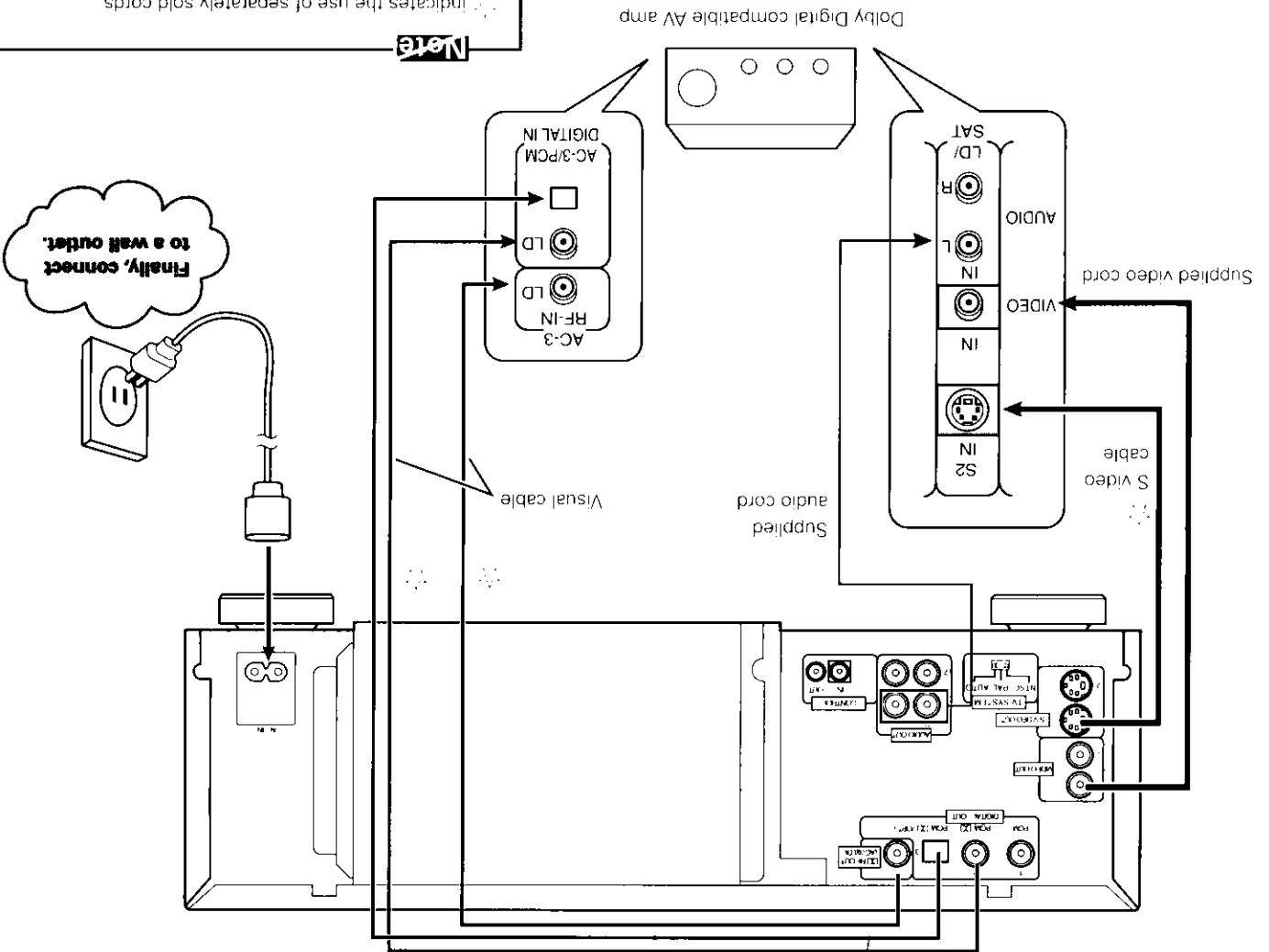

**Note**  
Ⓜ indicates the use of separately sold cords.

Some DVD format discs feature copy protect. With this kind of disc, when a sampling frequency of 96 kHz is selected, no signal is output from the digital output (see page 44).

When playing a disc with this player, switch the function to the connected input jack on the player. In the case of diagram above, select LD/SAT terminals.

### Connection example 3.

#### AV amplifier

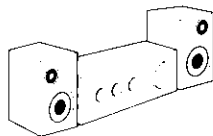

By connecting to a regular AV amp or stereo amp, you can enjoy playback with improved sound quality.

- Connect this player's audio output jacks to an amp's CD, LD, AUX or other audio input jacks. (Do not connect to PHONO jacks.)
- Connect this player's video output jack to the amp's video input jack.

#### Note

☆ indicates the use of separately sold cords.

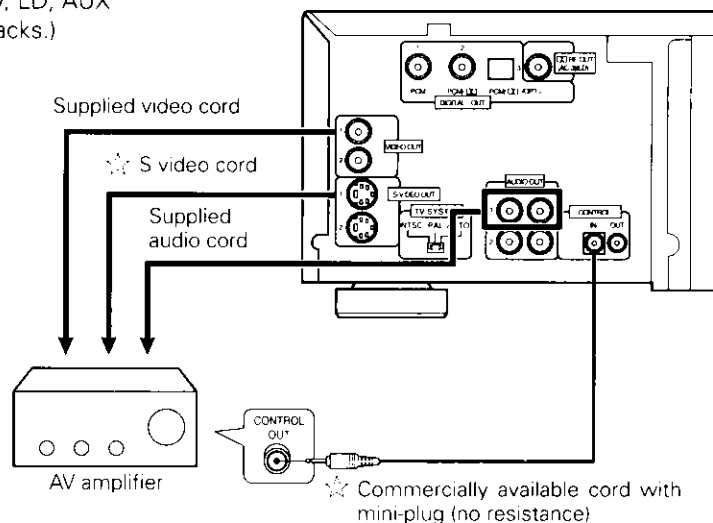

- **When connecting to a component bearing the Pioneer SR mark.**  
If you use a commercially available cord with mini plugs (no resistance) to connect this player's control input jack to the control output jack of the component bearing the SR mark, you can control the player as though it were a component in a system (system control).
- If you connect for system control, you cannot operate the player directly by pointing the remote control at it and pressing buttons.
- When controlling the unit as part of a system, be sure to connect to the amplifier with audio cord even if you are using only digital components.
- If your AV amplifier is a Dolby Pro Logic decoder, you can enjoy surround sound.
- For more details, refer to the connected component's operating instructions.

# Names and Functions

## Front panel

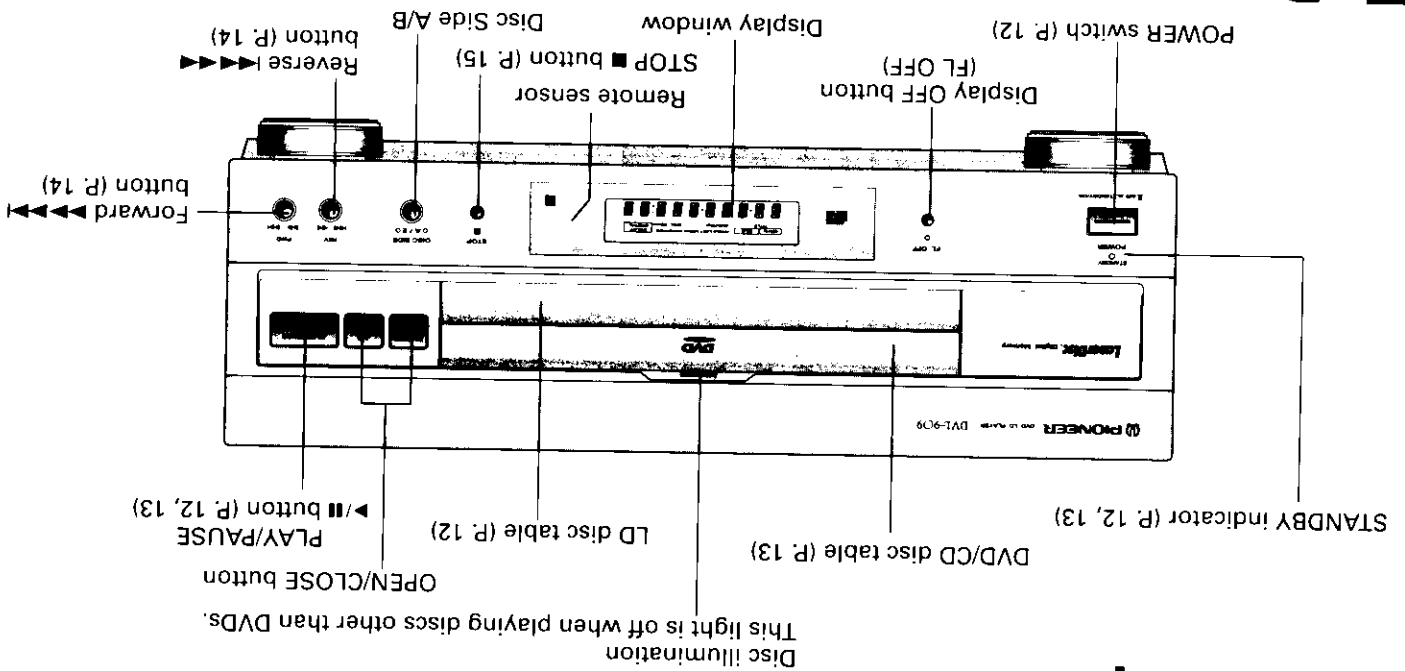

## Rear panel

Your amp		Optical Digital Output	
Regular digital amplifier	Coaxial	Coaxial	Connect to the PCM jack, and select PCM from a menu.
Regular digital amplifier	Optical	Optical	Connect to the optical jack, and select PCM from the menu.
AC-3 compatible amplifier	Coaxial	Coaxial	Connect to the PCM/DOLBY jack, and select PCM/DOLBY DIGITAL from the menu.
AC-3 compatible amplifier	Optical	Optical	Connect to the optical jack, and select PCM/DOLBY DIGITAL from the menu.

**Digital Output Jack (Coaxial)**  
This is used for output of the digital audio signal recorded on CDs, Video CDs and digital audio LDs. Depending on the components connect, noise may be generated.

**Digital Output**  
When connecting to an AC-3 compatible component, use the PCM/DOLBY jack. Use the PCM jack for all other components. (Refer to the chart on the right.)

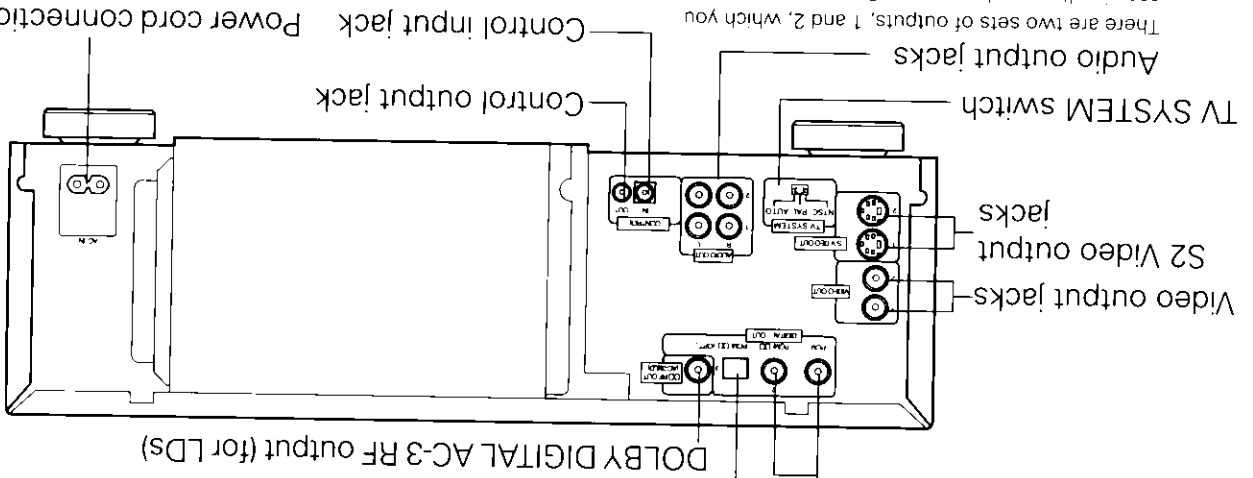

There are two sets of outputs, 1 and 2, which you can simultaneously connect. Connect 1 to the TV, and 2 to your AV amp.

## Names and Functions

### ■ Display window

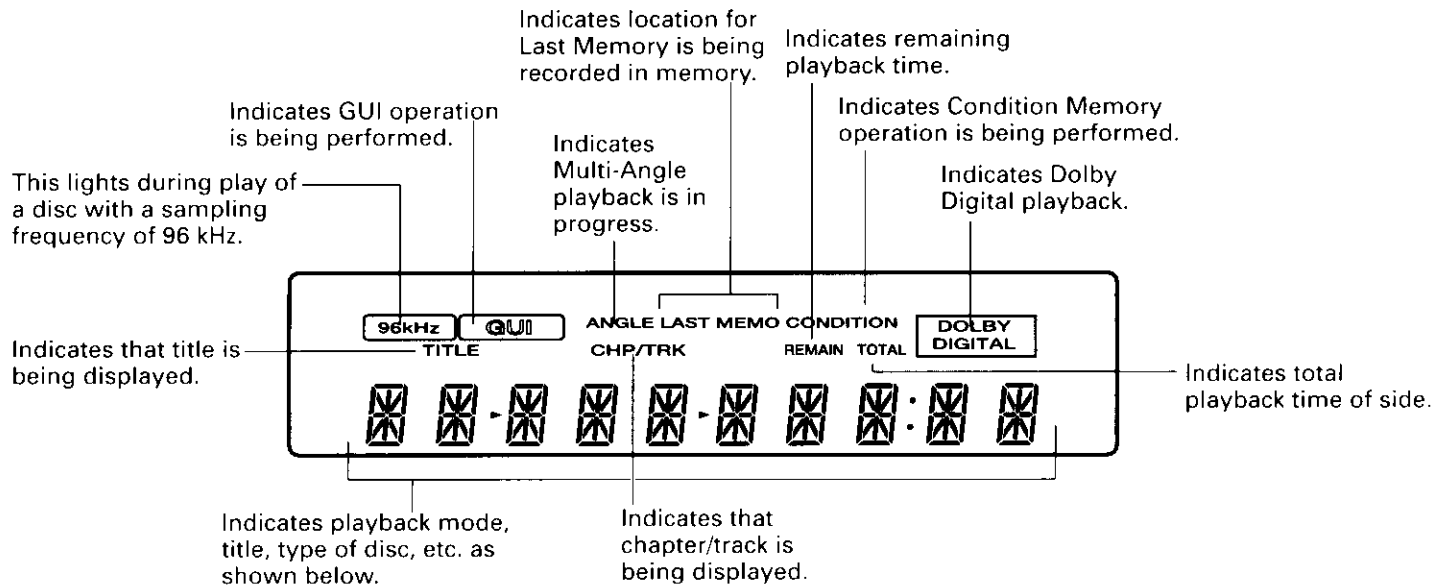

LD	:Laser Disc	STOP	:Stop
CD	:Compact disc	PAUSE	:Pause
CDV	:CD video	NO DISC	:No disc
DVD	:DVD	-- OFF --	:Power is turned off
VCD	:Video CD	MENU	:Menu mode
PBC PLAY	:During Video CD PBC play	TITLE	:Title menu
OPEN	:Disc table is opening or is open	CHAPTER	:Chapter menu
CLOSE	:Disc table is closing	SUB-TITLE	:Subtitle menu
RDM	:Random playback	SETUP	:Set-up menu
PROGRAM	:Program mode	AUDIO	:Audio menu
PGM	:Program playback	COND-MEM	:Condition Memory
R-TRK	:Repeat mode	LAST-MEM	:Last Memory
R-A	:Start point of 2 point repeat playback		
R-AB	:2 point repeat playback		
R-TTL	:Repeat playback of the title		
R-CHP	:Repeat playback of the chapter		
R-SID	:Both sides of LD repeat playback		
STEREO	:Stereo		
PLAY	:Playback		

# Remote control

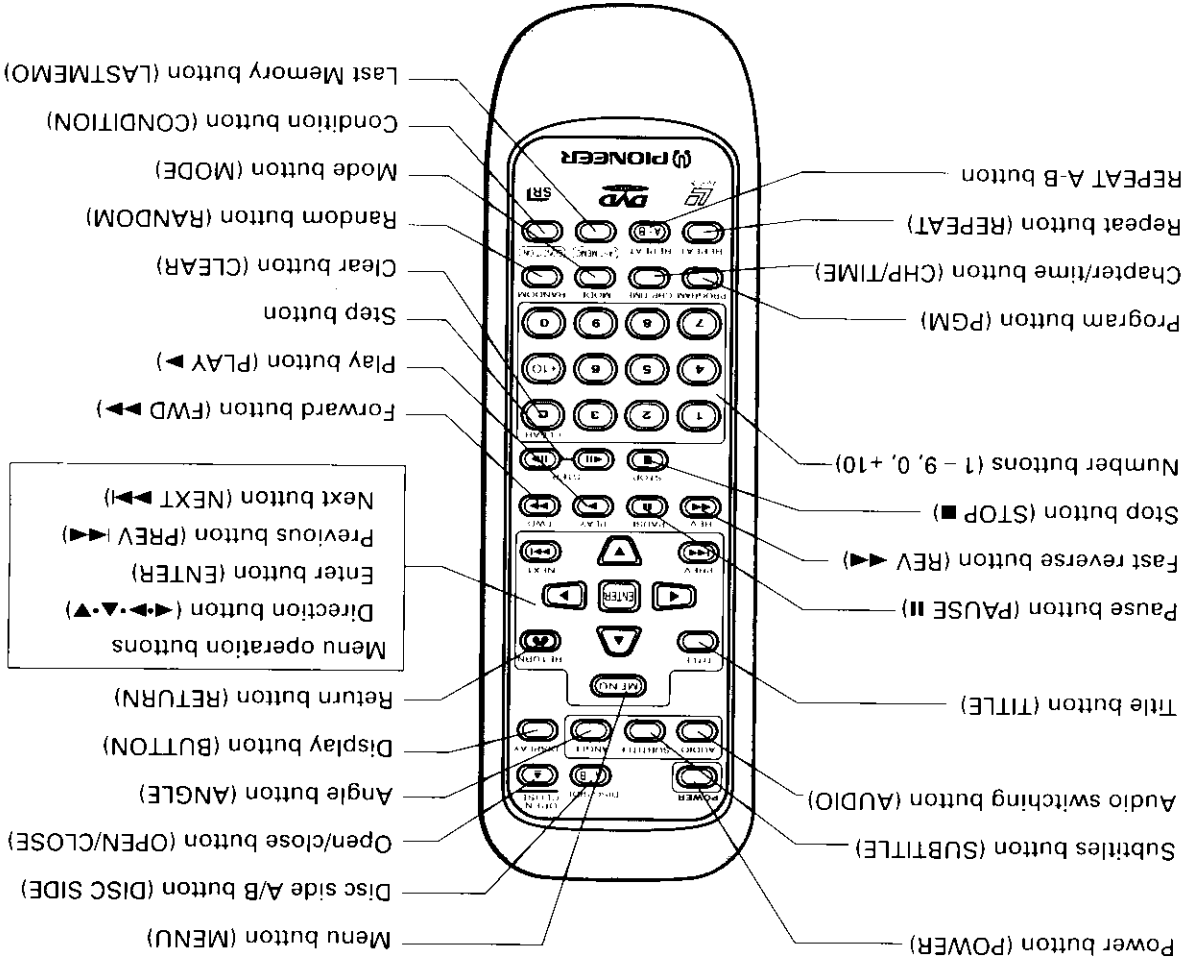

## Remote control operation

When operating the remote control, point it at the remote sensor located on the player's front panel. The remote control can be used up to 23 feet (7 m) from the player and within a 30° angle each side of the sensor.

- Exposing the remote sensor to direct sunlight or strong light may cause faulty operation.
- If the CONTROL IN jack on the player's rear panel is connected to another component, point the remote control at that component for operation. Operation is not possible when pointed at this player. (Refer to page 50.)
- When using the remote control, first press the POWER switch to turn on the player's power.

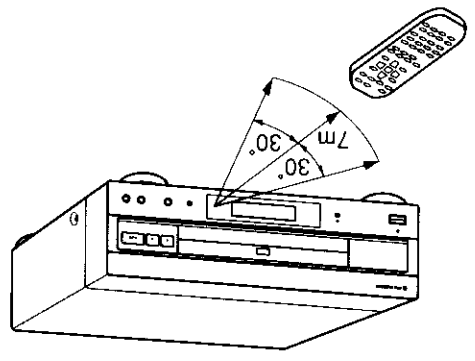

# Troubleshooting

Incorrect operations are often mistaken for trouble and malfunctions. If you think that there is something wrong with this component, check the points below. Sometimes the trouble may lie in another component. Inspect the other components and electrical appliances being used. If the trouble cannot be rectified even after exercising the checks listed below, ask your nearest PIONEER authorized service center or your dealer to carry out repair work.

	Symptom	Possible causes	Reference page
Operation	1. The disc table doesn't stay in even when it is closed.	<ul style="list-style-type: none"> <li>● The disc is dirty.</li> <li>● The disc is not correctly loaded in the disc table.</li> <li>● The region number is different.</li> </ul>	<p>p.6</p> <p>p.7</p> <p>p.56</p>
	2. Playback is not possible.	<ul style="list-style-type: none"> <li>● There's condensation inside the player.</li> <li>● SECAM system discs cannot be played.</li> </ul>	<p>p.5</p> <p>p.7</p>
	3. The picture is unclear during DVD play.	<ul style="list-style-type: none"> <li>● This player is compatible with copy guard analog copy protect technology. Some discs may feature a copy protect signal. Playing this kind of disc with some TVs may result in horizontal lines in part of the picture and other picture defects, but this does not mean the player is malfunctioning.</li> </ul>	
	4. If I record a DVD on a VCR and play it back, or play a DVD through a VCR, the picture is unclear.	<ul style="list-style-type: none"> <li>● This player is compatible with copy guard analog copy protect technology. Some discs may feature a copy protect signal. If you record this kind of disc on a VCR and play it back, or play this kind of disc through a VCR, the copy guard system prevents normal playback.</li> </ul>	p.3
	5. The  mark appears on screen.	<ul style="list-style-type: none"> <li>● The selected operation is not possible with that disc.</li> </ul>	
	6. The picture stops, and operation buttons do not function.	<ul style="list-style-type: none"> <li>● Press the STOP (■) button, and then press PLAY again.</li> </ul>	
	7. There's no picture. There's no color.	<ul style="list-style-type: none"> <li>● Check the TV SYSTEM switch setting.</li> </ul>	p.3
Remote control	8. The remote control doesn't operate.	<ul style="list-style-type: none"> <li>● The rear panel control input jack on the player is being used.</li> <li>● You are too far from the player. Or the angle between the remote control and the remote control reception window is too large.</li> <li>● The remote control's batteries are dead.</li> <li>● Some TVs with wireless remote capability operate incorrectly with this player's remote control.</li> </ul>	p.50
	9. TV and other components operate incorrectly.		
Audio	10. There's no sound. Sound is distorted.	<ul style="list-style-type: none"> <li>● Plugs are not pushed in sufficiently, or plugs are disconnected.</li> <li>● Connection plugs and jacks are dirty.</li> <li>● The player is connected to a stereo amp's PHONO input jack.</li> <li>● Audio cable connection is incorrect.</li> <li>● Play is paused.</li> <li>● Stereo amp operation is incorrect. (In particular, check that input selection for CD, LD etc. is correct.)</li> <li>● Digital output is set for 96kHz. Digital output may not be possible with certain discs.</li> </ul>	
	11. DVD sound volume level is low.	<ul style="list-style-type: none"> <li>● DVD sound volume level may sound lower than other discs, but this is due to the disc's recording system, and is not due to the player malfunctioning.</li> </ul>	

## Caution:

Abnormal functioning of this unit may be caused by static electricity, or other external interference. To restore normal operation, unplug the AC power cord and then plug it in again.

# Terms

## Dolby Digital (AC-3)\*

The maximum 5.1 channels of audio used in the surround system (Surround Digital) for movie theaters is digital data compressed by AC-3.



For DVD discs, the digital output PCM/Dolby (coaxial or optical) must be connected to the amplifier or processor's digital input AC-3/PCM jack. For LD discs, the AC-3 RF OUT (LD) jack must be connected to the amplifier's AC-3 RF IN jack.

## Virtual Dolby Surround\*\* (Surround)

Sound can be enjoyed virtually when a 2 channel output player is used. To virtualize the audio output, refer to "Switches to a more spacious sound" on page 33.

## PCM

PCM stands for Pulse Code Modulation and is digital audio. The digital audio of CD, LD or DVD discs is PCM.

## Title number

Title numbers refer to titles of movies etc. As DVD discs have a large capacity, many movies can be recorded on one disc. For example, when 3 different movies are recorded on a disc, they are divided into TITLE 1, TITLE 2 and TITLE 3. Playback can be operated by selecting the title number.

## Chapter number

Chapter numbers are the numbers assigned to sections on a title of the disc, similar to chapters in a book. If the disc includes these numbers, you can locate the section you want very quickly using chapter search and other functions. Some discs may not include chapter numbers.

## Frame number

This is the number recorded in each frame on a CAV disc. You can use frame numbers for such operations as Frame Search for a desired frame.

## Time number

The time number is the playback lapse time of a title in the disc from its beginning. The scene you want to locate can be searched for with the time number using the time number function etc.

\* Manufactured under license from Dolby Laboratories. "Dolby", "AC-3" and the double-D symbol are trademarks of Dolby Laboratories. Confidential Unpublished Works © 1992-1997 Dolby Laboratories, Inc. All rights reserved.

## LD (Laserdisc)

Depending on the signal recording method used, there are two types of Laserdiscs; Standard play discs (CAV) and Extended play discs (CLV).

## CAV

CAV disc jackets or labels are marked with "Standard play disc/CAV" or "Standard Play".

## CLV

CLV disc jackets or labels are marked with "Extended play disc/CLV" or "Extended Play".

## Laserdiscs with digital audio

These type of discs are recorded with digital audio signals in addition to the analog audio signals. This allows you to enjoy high quality digital sound along with the laser disc's high quality picture.

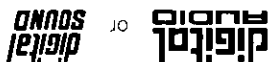

## Multi audio discs with digital sound

These type of discs are recorded with different types of digital audio and analog audio content.

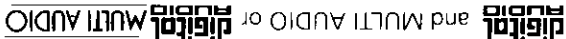

Digital audio or analog audio can be enjoyed by switching between them.

## Parental level

This function was suggested by parents. Parental level restrictions are restrictions incorporated into scenes that parents do not wish their children to view.

## TOC

TOC (Table Of Contents) information is data other than audio signal data, recorded at the beginning of a disc. As the name implies, it's like the list of contents in a book, with information such as the number of songs and playback time. ● Some LDs also feature a TOC. ● LDs and DVDs with a TOC belong to the "optical digital audio video disc system" family of discs.

\*\* SRS Labs, Inc.'s Trusurround system has been adopted as virtual technology. Trusurround is a trademark of SRS Labs, Inc. SRS and the SRS symbol are registered trademarks of SRS Labs, Inc. in the United States and selected foreign countries. Trusurround is incorporated under license from SRS Labs, Inc. Permission for use of Trusurround technology has been registered through SRS Labs, Inc.

## Terms

### Video CDs

These discs provide MD quality sound, and VHS quality video images. Thanks to MPEG1, the digital signal compression system, a single disc provides up to 74 minutes of continuous digital audio and video. There are also Video CDs with Playback Control (PBC) that let you select playback of desired scenes using menus, and view still images.

### Playback Control (PBC)

This refers to signals recorded on a Video CD (Version 2.0) enabling playback control.

You can use menus recorded on discs with PBC for easy, interactive Search for desired scenes, and playback.

You can also enjoy viewing high-resolution/standard resolution still images.

### High-resolution images

If the high-resolution still images are recorded in the Video CD, you can enjoy viewing them with four times the resolution of moving images.

### Screen saver

When a still picture is displayed for a long period a phenomena known as "screen burn" may occur.

To avoid this, computers are equipped with screen savers.

### Multi-angle

When you watch regular TV programs you are watching the image filmed through the TV camera. Because of this the picture is displayed on your TV from the view point of the TV camera's position. In a TV studio the image is filmed by many cameras at the same time, and one of those images is selected by the program director and transmitted to your household TV. If all the filmed images were transmitted to your TV you would be able to select the camera image you want. Some DVD discs are recorded with the angles of all camera's used for filming and these can be selected using this player. These types of discs are called multi-angle discs.

### Subtitle

Subtitles are language titles superimposed on movies etc. Up to 32 different subtitle languages can be recorded on a DVD disc. The subtitle function can be used to select the language of your choice.

### Aspect ratio

Aspect ratio refers to the length to height ratio of TV screens. The ratio of a normal TV is 4:3, while the ratio of a Hi-vision TV or wide TV is 16:9. This allows you to enjoy a picture with a wider perspective.

### Condition memory

"Condition" refers to the various mode settings etc. On this player, various conditions, such as those set during playback etc. can be memorized. This function allows you to play back the same disc at any time without having to reset the condition settings.

### Regional restriction codes (region number)

Regional restriction codes are built-in to DVD players and DVD discs for each sales region. If the regional code of the DVD player does not match one of the regional codes of the DVD disc, playback will not be possible. At this time an indicator will appear on the screen.

The region number is described on the rear panel.

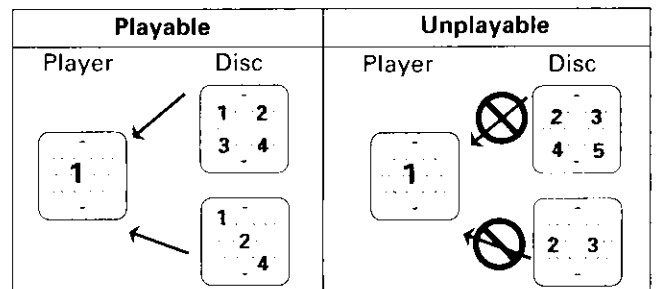

### Optical digital output

Normally, audio is converted to an electric signal and transmitted through an electric wire from the player to the amplifier etc. Changing this signal to a digital signal and transmitting it through an optical fibre cable is called optical digital output. (Optical digital input is the side receiving the signal such as the amplifier etc.)

You can switch the setting of the optical digital output.

- PCM/☐: Choose this setting when connecting to the Dolby Digital (AC-3) optical digital input of an amp equipped with a Dolby Digital (AC-3) decoder.
- PCM: Choose this setting when connecting to the optical digital input of a regular amp, a Dolby Pro Logic amp etc.

### Dynamic range

Dynamic range refers to the difference between the maximum conversion level for transmission/conversion of distortion free signals and noise and/or the minimum level limited by the equipment's characteristics. Decibel units (dB) are used.



# Specifications

## General

System ..... DVD system, LaserVision Disc system and Compact Disc digital audio system  
 Laser ..... Semiconductor laser: wavelength 650 nm, 780 nm  
 Power requirements: ..... AC 110 - 127/220 - 240 V, 50/60 Hz  
 Power consumption ..... 57 W  
 Weight ..... 8.9 kg  
 Dimensions ..... 420 (W) x 464 (D) x 146 (H) mm  
 (Not including protruding cables, etc.)  
 Operating temperature ..... +5°C to +35°C  
 Operating humidity ..... 5% to 85% (no condensation)

## Video Output (2 pairs)

Jacks ..... RCA jacks  
 Output level ..... 1 Vp-p (75  $\Omega$  when loaded, synchronous negative)  
 Y (luminance) - Output level ..... 1 Vp-p (75  $\Omega$ )  
 C (color) - Output level ..... 286 mVp-p (75  $\Omega$ )  
 S-Video jacks ..... S VIDEO jacks

## S-Video Output level (2 pairs)

Jacks ..... RCA jacks  
 Output level ..... 1 Vp-p (75  $\Omega$  when loaded, synchronous negative)  
 Y (luminance) - Output level ..... 1 Vp-p (75  $\Omega$ )  
 C (color) - Output level ..... 286 mVp-p (75  $\Omega$ )  
 S-Video jacks ..... S VIDEO jacks

## Audio Output (2 pairs)

Output level ..... 200 mVrms (1 kHz, -20 dB)  
 During digital audio output ..... 200 mVrms (1 kHz, -20 dB)  
 Number of channels ..... 2  
 Jacks ..... RCA jacks

## Digital audio characteristics

Frequency response	4 Hz to 22 kHz (DVD fs: 48 kHz)
S/N ratio	115 dB (EIAJ)
Dynamic range	97 dB (EIAJ)
Total harmonic distortion	0.003 %
Wow and flutter	Limit of measurement ( $\pm 0.001$ % W, PEAK) or lower (EIAJ)

## Other Terminals

Optical digital output (PCM/DD) ..... RCA jack  
 Coaxial digital output (PCM/DD) ..... RCA jack  
 Coaxial digital output (PCM) ..... RCA jack  
 AC-3 RF output (for LD) ..... RCA jack  
 CONTROL IN ..... Minijack (3.50)  
 CONTROL OUT ..... Minijack (3.50)

## Accessories

Remote control unit ..... 1  
 AA/R6P dry cell batteries ..... 2  
 Audio cord ..... 1  
 Video cord ..... 1  
 Power cord ..... 1  
 Operating instructions ..... 1  
 Warranty card ..... 1  
 (With region number "1" models only)

## NOTE:

The specifications and design of this product are subject to change without notice, due to improvement.