

LDP-1600P

SERVICE MANUAL

*AEP Model
UK Model*

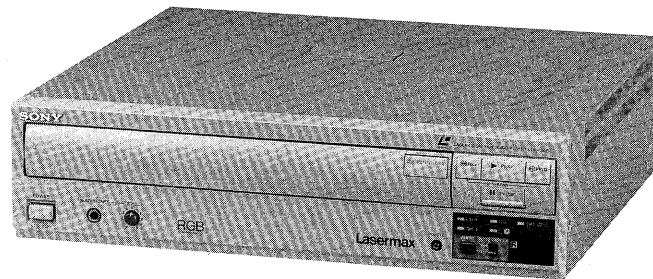

Lasermax

R.G.B output is added in LDP-1600P as compared with LDP-1550P. By this change, VP-10 board is changed sharply.(VP-11 board)

The electrical and mechanical specifications of LDP-1600P are almost identical to those of LDP-1550P.

This manual contains only the points which differ from LDP-1550P. Refer to the LDP-1550P service manual for related information not contained in this manual.

SPECIFICATIONS

Playback system

Disc format	Laser Vision
Pick-up method	Laser beam (reflective)
Laser	Diode laser ($\lambda = 7800\text{\AA}$)
Videodisc	12" and 8"
Maximum playing time	CAV: 36 min/side CLV: 60 min/side
Spindle revolution	CAV: 1500 r.p.m. CLV: 1500 to 570 r.p.m.
Access time	CAV: 2 sec (by frame) 10 sec (by chapter) CLV: 10 sec

Video

CVBS output	CCIR standards, PAL colour 1.0 V p-p, 75 ohms unbalanced, sync negative
Video bandwidth	RGB: 5 MHz CVBS: 3 MHz

Audio

Output	Line out: Less than 2 kilohms 0 dBV (100% MOD, 1 kHz, 47 kilohms terminated) unbalanced Headphones: 8 ohms -20 dBV max.
Signal-to-noise ratio	CX ON: 70 dB CX OFF: 56 dB
Frequency response	20 Hz to 20kHz

Video/Audio (TV connector)

CVBS output	1.0 Vp-p, 75 ohms unbalanced
RGB output	0.7 Vp-p, 75 ohms unbalanced
Audio	-1.8 dBV
Status	+11 V DC
RGB status	+2.5 V DC

General

Power requirements	220/240V AC, selectable, 50/60 Hz
Power consumption	36 W
Operating temperature	5°C to 35°C (40°F to 95°F)
Operating humidity	25% to 80%
Storage temperature	-20°C to 60°C (-4°F to 140°F)
Dimensions	Approx. 424 × 116 × 405 mm (w/h/d) (16 ³ / ₄ × 4 ⁵ / ₈ × 16 inches)
Weight	Approx. 10.7 kg (23 lb 9 oz)
Supplied accessory	AC power cord
Optional accessories	Interface Manual LDM-1550 Rack Mount Kit RMM-201B Remote Control Unit RM-2001 External Sync Lock Board DB-1550P

Note

This appliance conforms with EEC Directives 76/889 and 82/499 regarding interference suppression.



L VIDEODISC PLAYER
LaserVision
SONY®

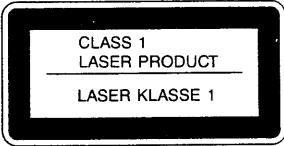

This videodisc player is classified as CLASS 1 LASER PRODUCT. The CLASS 1 LASER PRODUCT label is located on the rear panel of the player.

DANGER
Invisible laser radiations when open and interlock failed or defeated. Avoid direct exposure to beam.

CLASS I LASER PRODUCT

CLASS 3A LASER

CAUTION

The operating voltage of this unit is preset at the factory to 240 V AC. If you operate the unit on 220 V AC, disconnect the AC power cord and set the voltage selector located on the rear panel to 220 V AC.

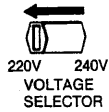

FOR THE CUSTOMERS IN THE UNITED KINGDOM

THIS APPARATUS MUST BE EARTHED

IMPORTANT

The wires in this mains lead are coloured in accordance with the following code:

- Green-and-yellow : Earth
- Blue : Neutral
- Brown : Live

As the colours of the wires in the mains lead of this apparatus may not correspond with the coloured markings identifying the terminals in your plug proceed as follows:

The wire which is coloured green-and-yellow must be connected to the terminals in the plug which is marked by the letter E or by the safety earth symbol \perp or coloured green or green-and-yellow. The wire which is coloured blue must be connected to the terminal which is marked with the letter N or coloured black. The wire which is coloured brown must be connected to the terminal which is marked with the letter L or coloured red.

Features

RGB output

The LDP-1600P is equipped with RGB output which makes possible superb picture quality at the full bandwidth of 5 MHz in all modes.

CVBS output

The LDP-1600P is also equipped with CVBS output. This is a PAL encoded version of the RGB output signal or the direct output signal which is selectable on the board switch.

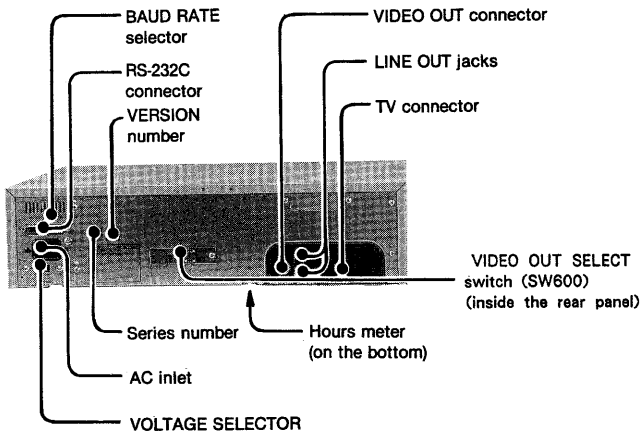

TV connector

21-pin (CENELEC standard) connector for video and audio signal outputs.

If your monitor TV has a connector of the same type, connect the cable (with the square 21-pin plugs) to this connector to supply the video and audio signals to the monitor TV with a single cable.

Pin assignment

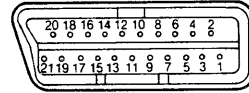

Pin No.	Signal	Pin No.	Signal	Pin No.	Signal
1	Audio B	8	Status (+11V)	15	Red
2	NC	9	Green (G)	16	RGB Status (+2.5V)
3	Audio A	10	NC	17	Video (G)
4	Audio (G)	11	Green	18	NC
5	Blue (G)	12	NC	19	Video
6	NC	13	Red (G)	20	NC
7	Blue	14	NC	21	GND

NC: no connection

VIDEO OUT SELECT switch (SW600)

Factory preset position is OFF. By turning ON SW600, the direct video signal (composite video signals) can be output from BNC VIDEO out connector on FWD PLAY. Besides, when this switch is ON, in the moment of changing FWD PLAY to a trick play (or a trick play to FWD PLAY), the color framing goes out of order.

SECTION 3 DIAGRAMS

3-1. LOCATION OF THE PRINTED CIRCUIT BOARDS

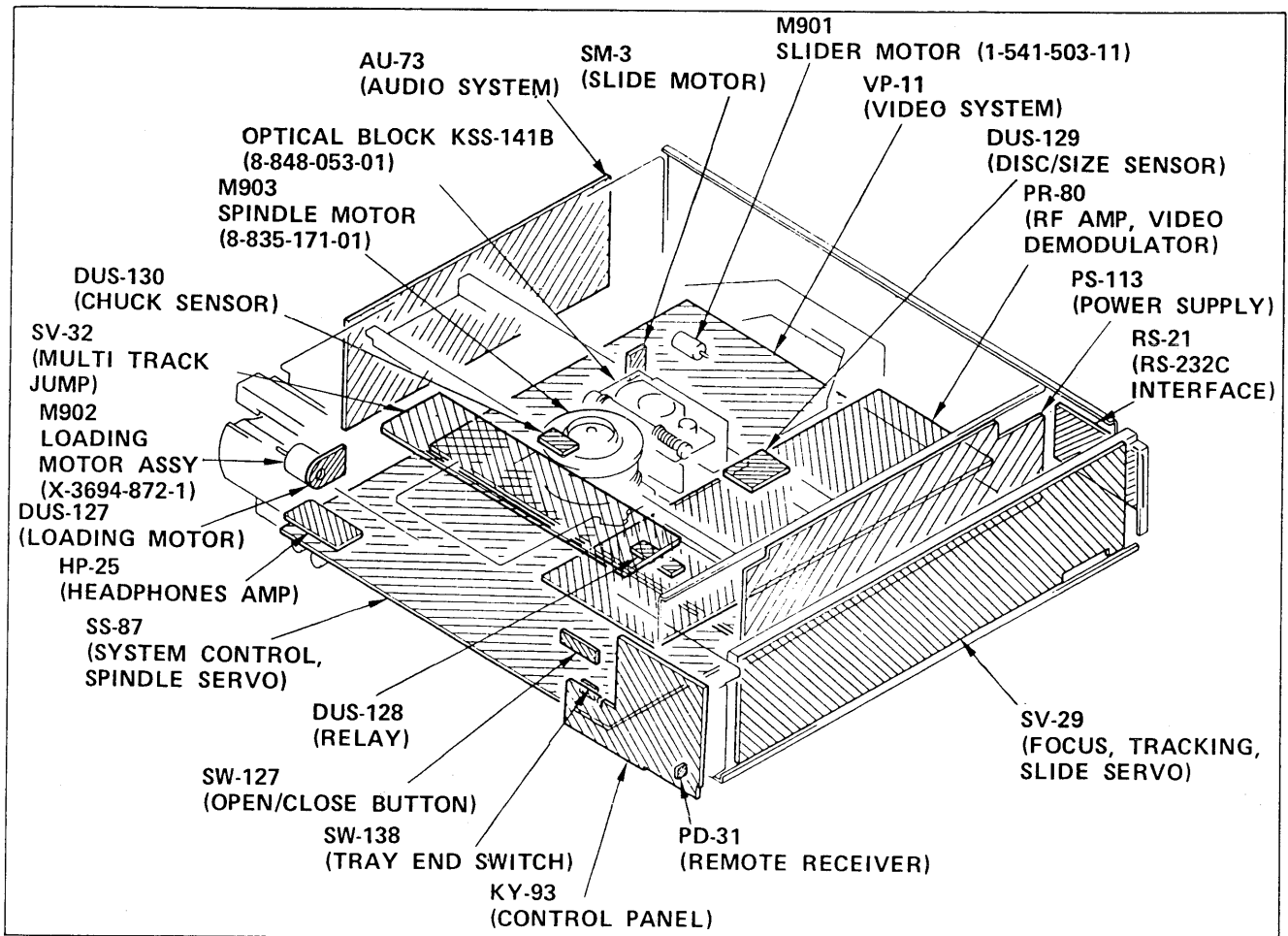

3-2. OVERALL BLOCK DIAGRAM

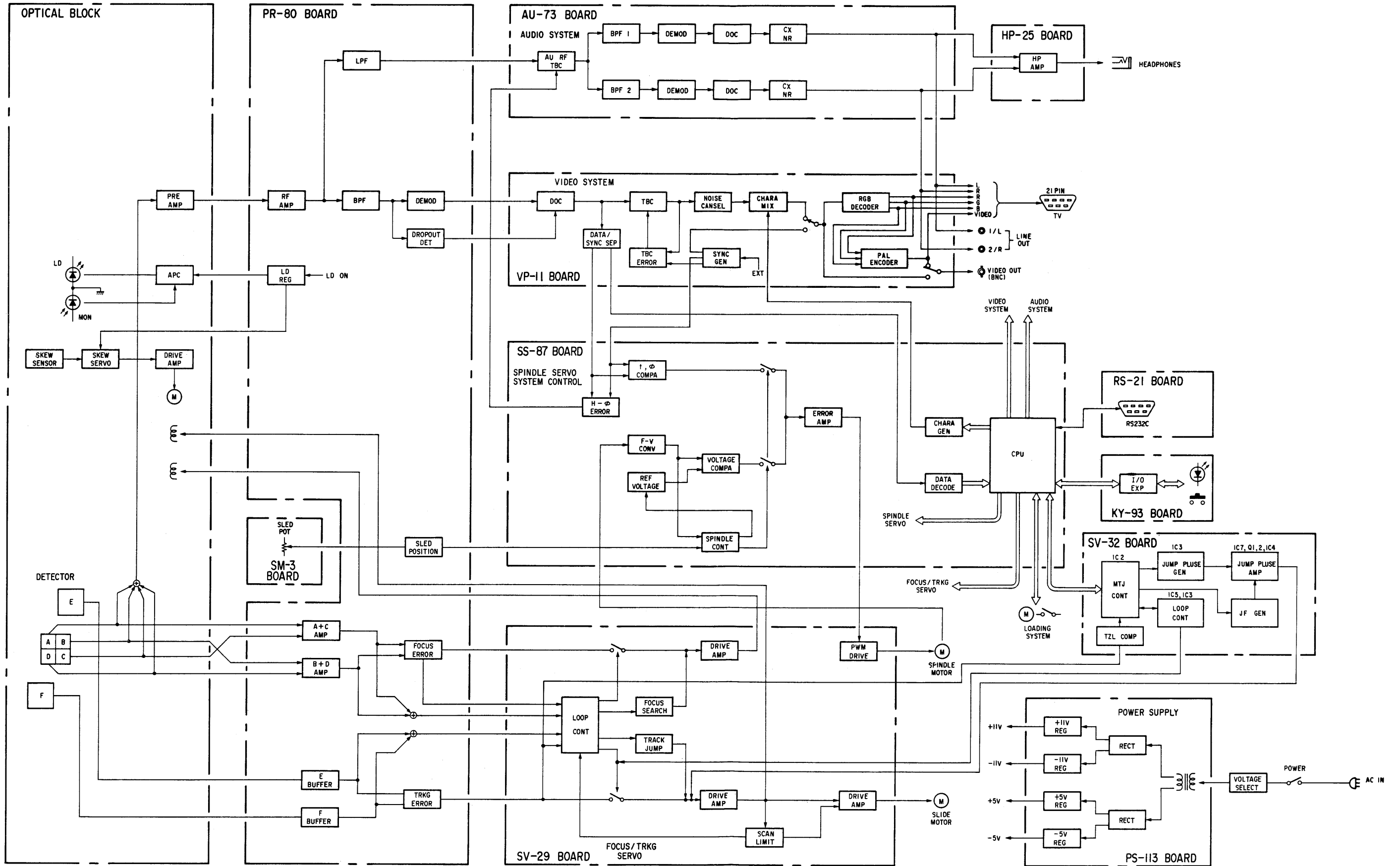

3-3. VIDEO SYSTEM BLOCK DIAGRAM

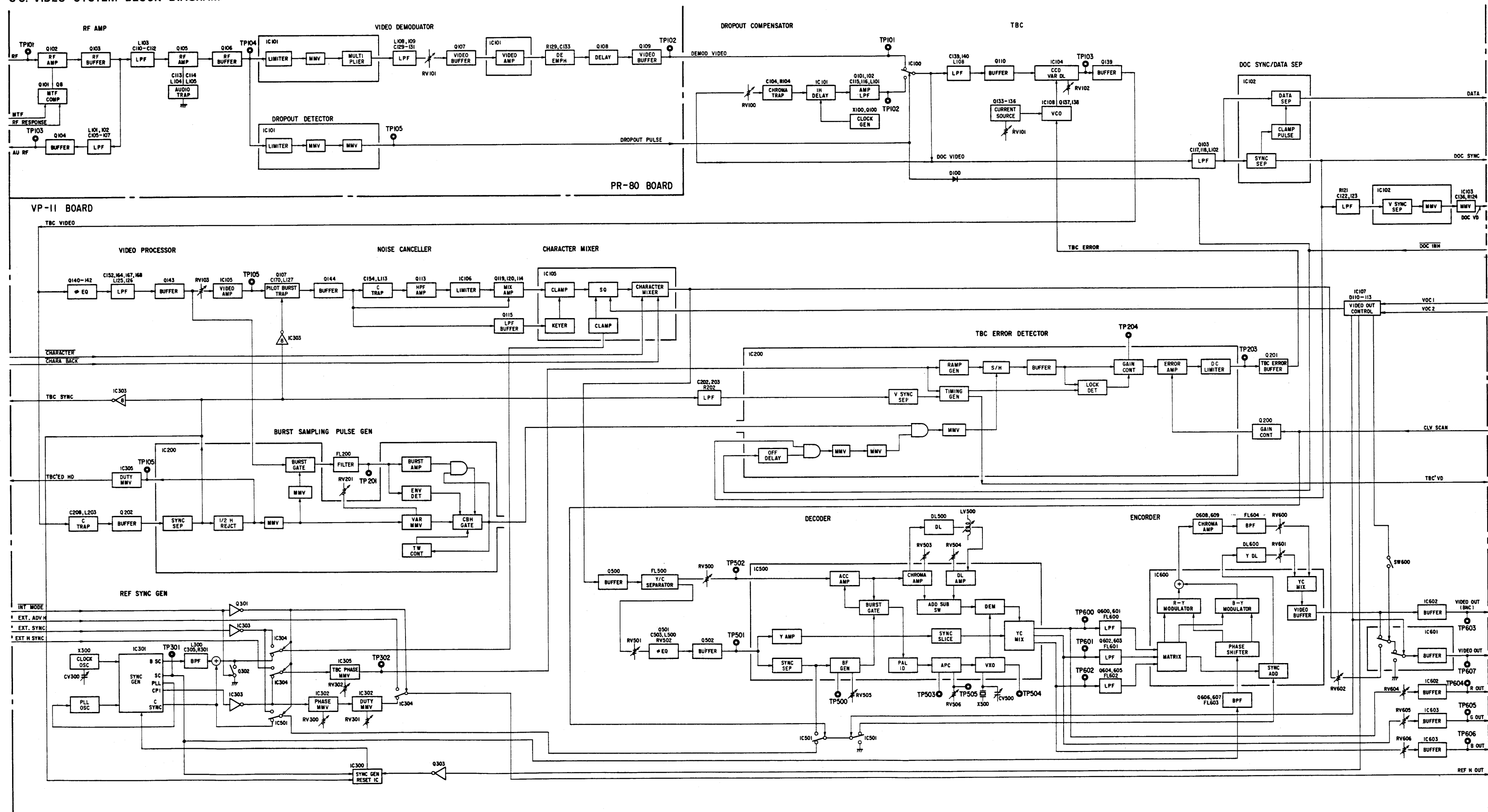

SECTION 4

PRINTED WIRING BOARDS AND SCHEMATIC DIAGRAM

4-1. FRAME SCHEMATIC DIAGRAM

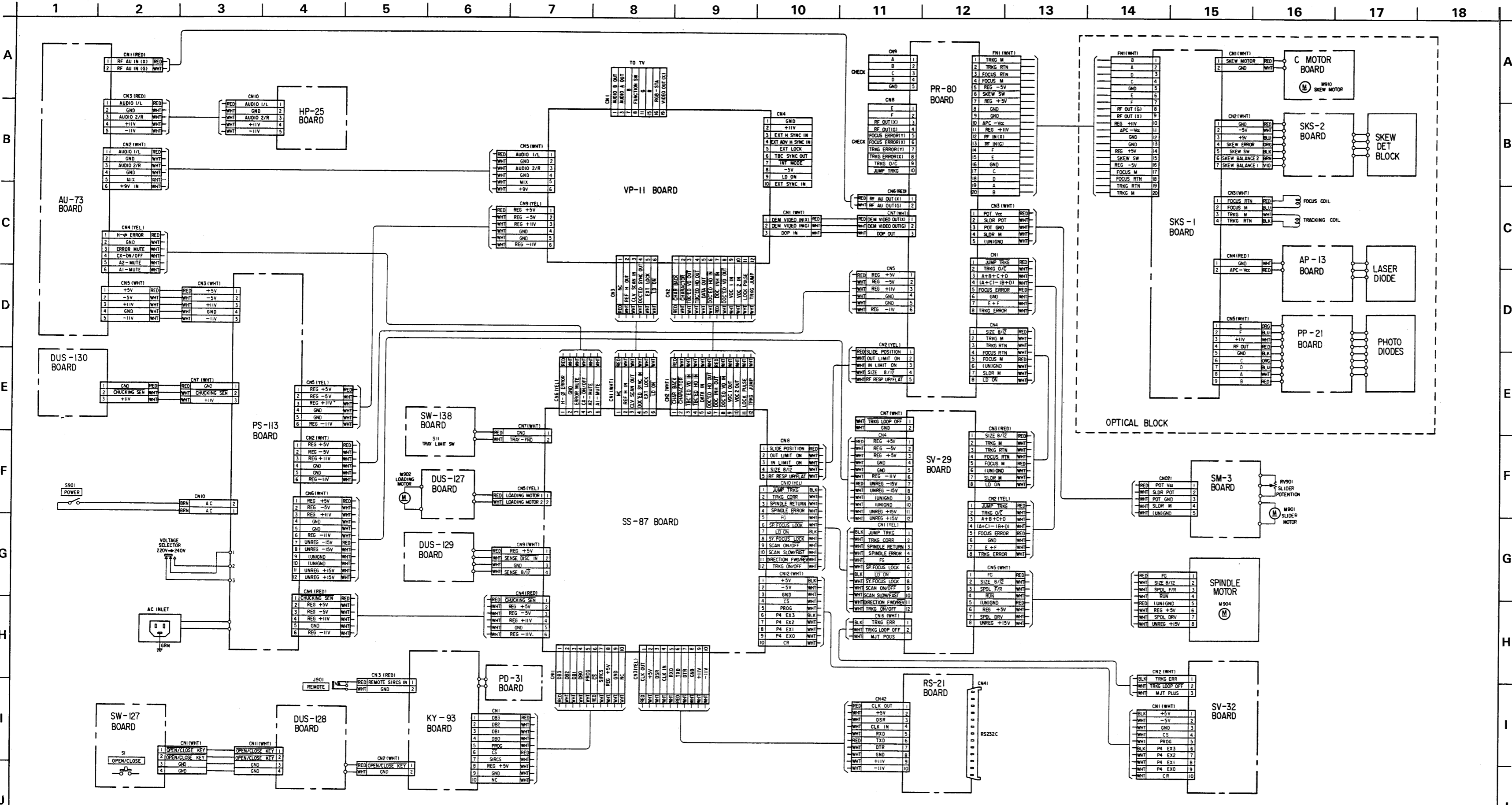

4-2. VP-11 (VIDEO SYSTEM) PRINTED WIRING BOARD

-Ref.No.VP-11 BOARD : 2,000 series-

For printed wiring boards :

- : indicates a lead wire mounted on the component side.
- : indicates a lead wire mounted on the printed side.
- ▨ : Pattern from the side which enables seeing.
- : Circled numbers refer to waveforms.

For schematic diagram :

- All resistors are in ohms, 1/4W unless otherwise noted. kΩ : 1000 Ω, MΩ : 1000k Ω.
- All capacitors are in μF unless otherwise noted. pF : μ F 50V or less are not indicated except for electrolytics and tantalums.
- All variable and adjustable resistors have characteristic curve B, unless otherwise noted.
- : panel designation.
- △ : internal component.
- △ : adjustment for repair.
- : B+ line.
- : B- line.
- Volts are dc between measurement points and ground unless otherwise noted.
- Readings are taken with playback a color-bar signal on the reference disc.
- Readings are taken with a digital multimeter (DC10M Ω).
- Voltage variations may be noted due to normal production tolerances.
- ▨ : IN/OUT direction of B line (+, -).
- Circled numbers refer to waveforms.

When indicating parts by reference number, please include the board name.

Note: The components identified by mark △ or dotted line with mark △ are critical for safety. Replace only with part number specified.

VP-11 BOARD

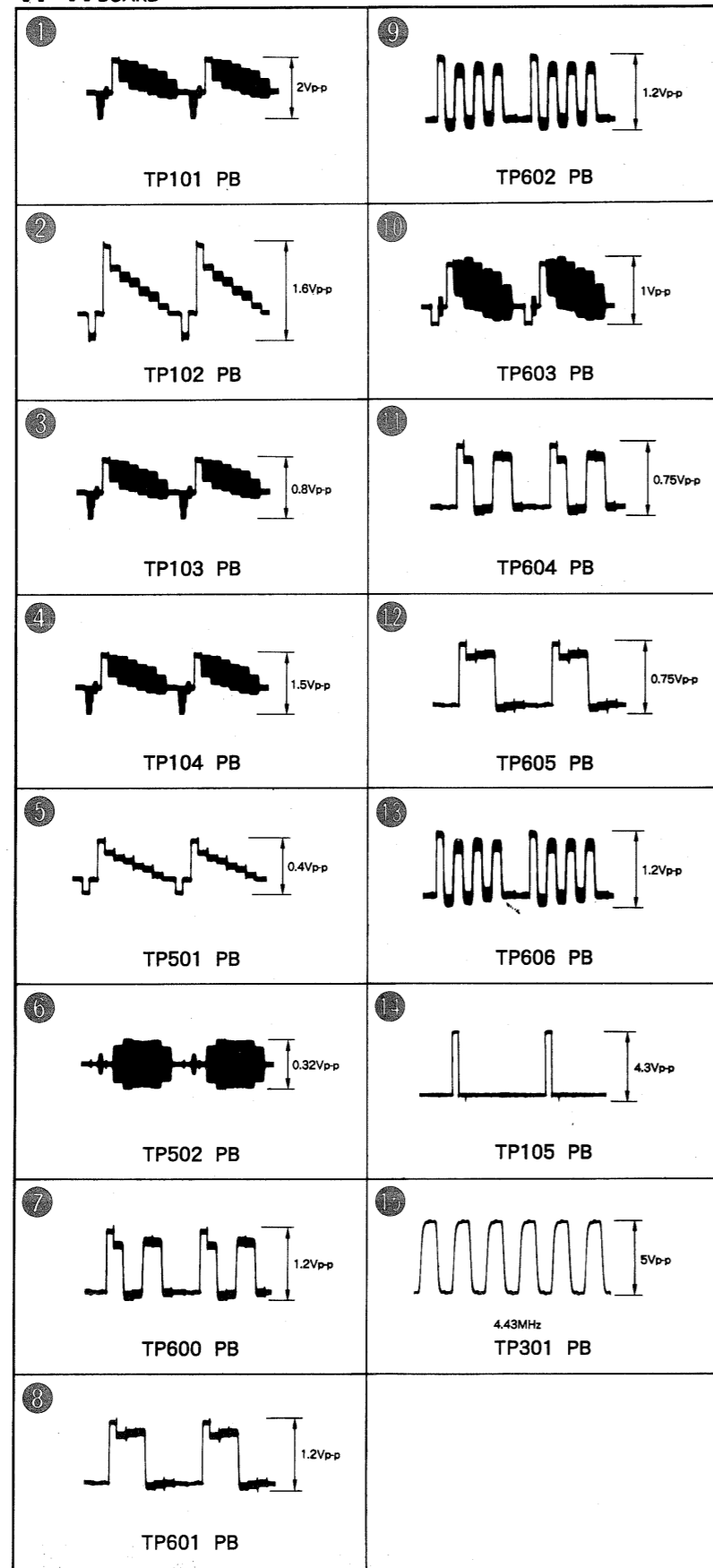

VP-11 BOARD

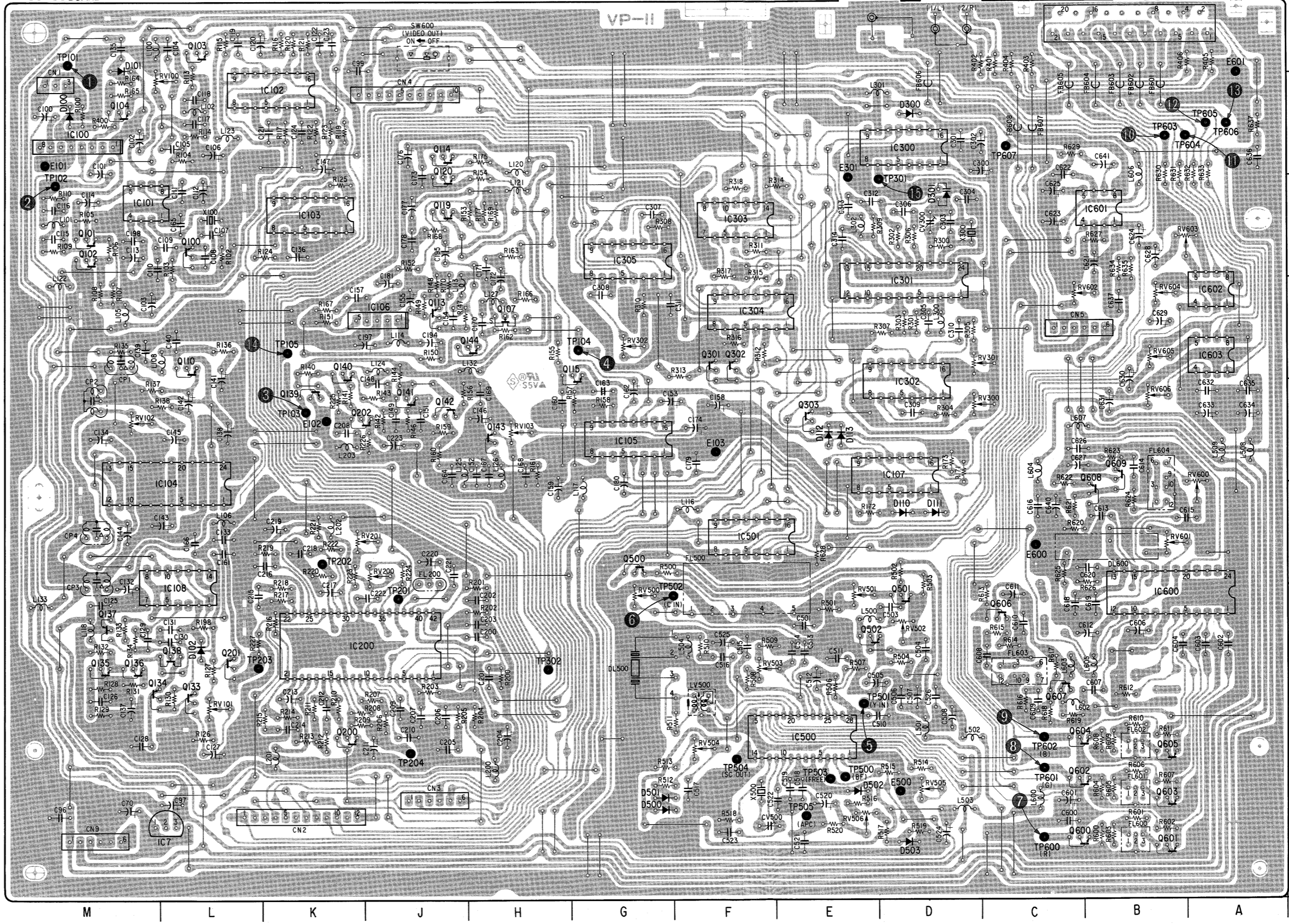

VP-11 BOARD		VP-11 BOARD	
CN001	M-8	RV100	M-8
CN002	K-1	RV101	L-2
CN003	J-1	RV102	M-5
CN004	J-8	RV103	H-5
CN005	C-6	RV200	J-4
CN009	M-1	RV201	K-4
		RV300	D-5
CN1001	C-9	RV301	D-6
		RV302	G-6
CV300	D-7	RV500	G-3
CV500	F-1	RV501	E-3
		RV502	D-3
D100	E-8	RV503	F-3
D101	M-9	RV504	F-2
D102	L-3	RV505	D-2
D110	D-4	RV506	E-1
D111	D-4	RV600	A-4
D112	E-5	RV601	B-4
D113	E-5	RV602	C-6
D300	D-8	RV603	A-7
D301	D-7	RV604	B-6
D500	G-1	RV605	B-6
D501	G-1	RV606	B-5
D502	E-1		
D503	D-1	TP101	M-9
		TP102	M-8
IC007	L-1	TP103	K-5
IC100	M-8	TP104	H-6
IC101	M-7	TP105	K-6
IC102	K-8	TP201	J-3
IC103	K-7	TP202	K-4
IC104	L-4	TP203	L-3
IC105	G-5	TP204	J-2
IC106	J-6	TP301	E-7
IC107	D-5	TP302	H-3
IC108	L-3	TP500	E-2
IC200	K-3	TP501	E-2
IC300	D-8	TP502	G-3
IC301	D-6	TP503	E-2
IC302	D-5	TP504	F-2
IC303	F-7	TP505	E-1
IC304	F-6	TP600	C-2
IC305	G-7	TP601	C-2
IC500	E-2	TP602	C-2
IC501	F-4	TP603	B-8
IC600	B-3	TP604	A-8
IC601	B-7	TP605	A-8
IC602	A-6	TP606	C-8
IC603	A-6	TP607	C-8
LV500	F-2	E101	M-8
		E102	K-5
Q100	L-7	E301	E-7
Q101	M-7	E500	D-1
Q102	M-7	E600	C-4
Q103	L-9	E601	A-9
Q104	M-8		
Q107	H-6		
Q110	L-6		
Q111	J-6		
Q113	J-6		
Q114	J-8		
Q115	H-6		
Q119	J-7		
Q120	J-7		
Q133	L-2		
Q134	M-2		
Q135	M-3		
Q136	M-3		
Q137	M-3		
Q138	L-3		
Q139	K-5		
Q140	K-6		
Q141	J-5		
Q142	J-5		
Q143	H-5		
Q144	J-6		
Q200	K-2		
Q201	L-3		
Q202	K-5		
Q301	F-6		
Q302	F-6		
Q303	F-6		
Q500	G-4		
Q501	D-3		
Q502	E-3		
Q600	C-1		
Q601	B-1		
Q602	C-2		
Q603	B-1		
Q604	C-2		
Q605	B-2		
Q606	C-3		
Q607	C-2		
Q608	B-4		
Q609	B-5		

—Ref.No.VP-11 BOARD : 2,000 series—

A
B
C
D
E
F
G
H
I
J
K
L
M
N

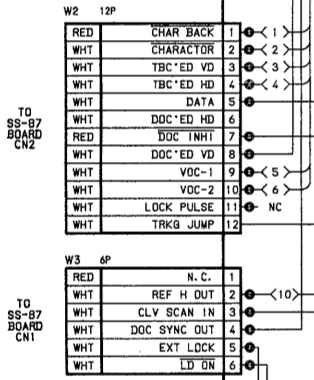
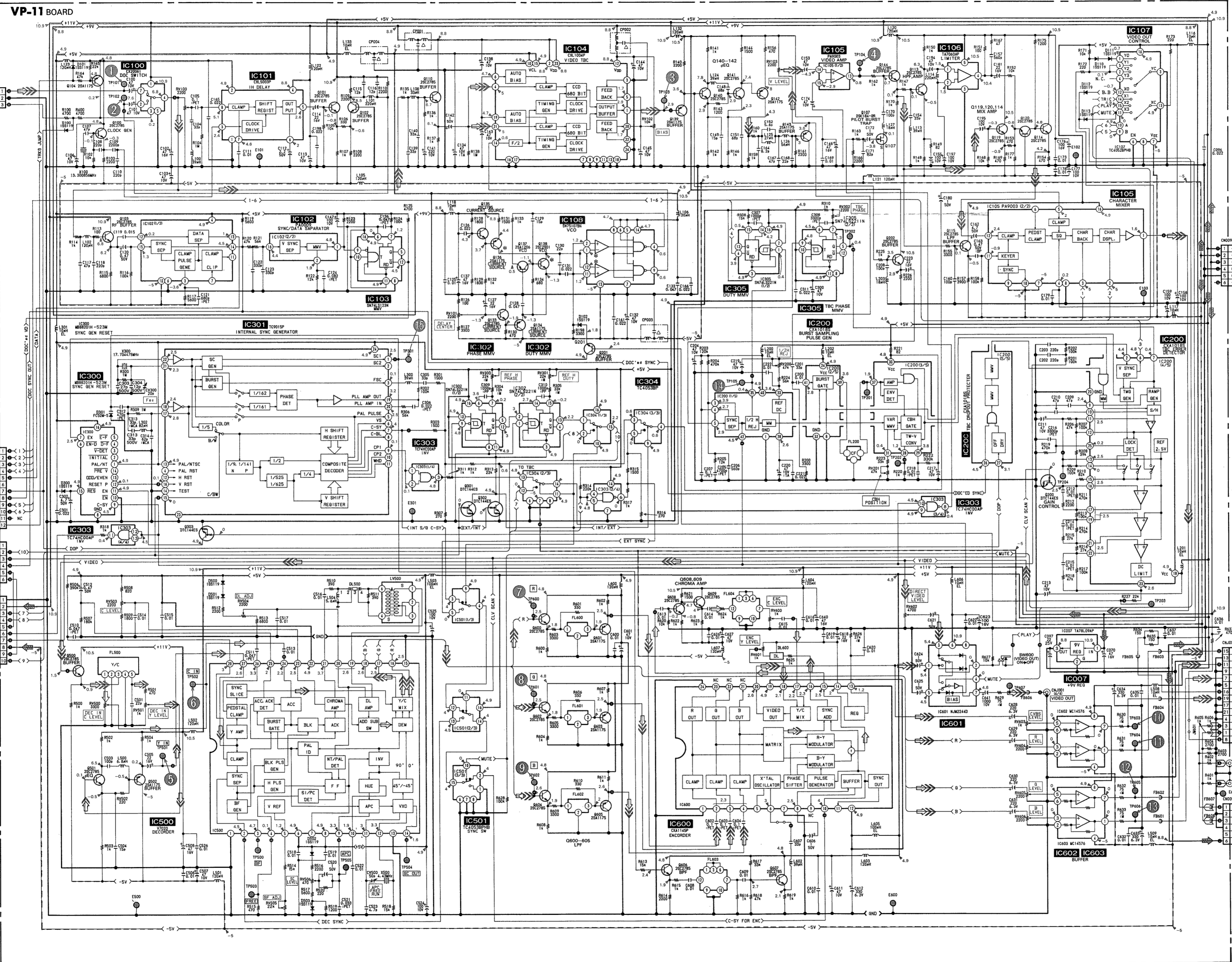

- SEMICONDUCTORS**
- | | |
|------------|-----------|
| TA78L009AP | 25C2785 |
| DTC114ES | 2SK184-GR |
| 2SA733-K | FC52M-5 |
| 2SA1206 | 1SS119 |
| 25C2901 | |

• Signal Path.
 ⊕ : IN/OUT direction of B line (+, -).
 ⊕ : PB VIDEO Signal.
 ⊕ : PB Y Signal.
 ⊕ : PB CROMA Signal.
 ⊕ : PB AUDIO Signal.



A
B
C
D
E
F
G
H
I
J
K
L
M
N

When indicating parts by reference number, please include the board name.

[DIFFERENCE OF MECHANICAL PARTS AND ACCESSORIES]

No.	DESCRIPTION	MODEL	LDP-1550P Part No.	LDP-1600P Part No.	Page on LDP-1550P Service Manual
1	PANEL ASSY, FRONT		X-3688-260-1	X-3694-880-1	91
14	PANEL ASSY, FRONT		A-6408-095-A	deleted	91
61	BEARING (NO FLANGE), BALL		3-694-820-01	3-656-990-00	94
160	PANEL (P), REAR		* 3-710-305-11	* 3-710-305-21	98
162	LABEL, CLASS 1		* 4-885-838-00	not supplied	98
164	RS-21 BOARD		* 1-618-835-11	changed to the next	98
164	RS-21 BOARD, COMPLETE		—————	* A-6421-200-A	—
171	VP-10 BOARD, COMPLETE		A-6421-203-A	changed to the next	98
171	VP-11 BOARD, COMPLETE		—————	A-6421-285-A	—
209	MOTOR ASSY (LOADING) (M902)		X-3694-872-1	changed to the next	100
209	MOTOR, DC (DNR-8300A) (LOADING) (M902)		—————	1-542-502-11	—
224	BRACKET ASSY, S		* X-3694-805-2	X-3694-805-1	100
	MISCELLANEOUS				
M902	MOTOR ASSY (LOADING)		X-3694-872-1	changed to the next	122
M902	MOTOR, DC (DNR-8300A) (LOADING)		—————	1-542-502-11	—
	ACCESSORIES AND PACKING MATERIALS *****				
	INDIVIDUAL CARTON		* 3-694-973-11	* 3-710-384-01	122
	MANUAL, INSTRUCTION		△ 3-769-820-11	3-786-850-11	122

- Items marked "★" are not stocked since they are seldom required for routine service. Some delay should be anticipated when ordering these items.

The components identified by mark  or dotted line with mark  are critical for safety. Replace only with part number specified.

SECTION 6 ELECTRICAL PARTS LIST

NOTE:

The components identified by mark or dotted line with mark are critical for safety. Replace only with part number specified.

When indicating parts by reference number, please include the board name.

- Due to standardization, replacements in the parts list may be different from the parts specified in the diagrams or the components used on the set.
- RESISTORS
All resistors are in ohms
METAL: Metal-film resistor
METAL OXIDE: Metal Oxide-film resistor
F: nonflammable
- Items marked "★" are not stocked since they are seldom required for routine service. Some delay should be anticipated when ordering these items.
- -XX, -X mean standardized parts, so they may have some difference from the original one.
- SEMICONDUCTORS
In each case, U: μ , for example:
UA.....: μA, UPA.....: μPA,
UPB.....: μPB, UPC.....: μPC,
UPD.....: μPD
- CAPACITORS
MF: μF , PF: $\mu\mu F$
- COILS
MMH: mH, UH: μH

Ref.No	Part No.	Description	Remark	Ref.No	Part No.	Description	Remark
*A-6421-285-A	VP-11 BOARD, COMPLETE	(Ref. No 2,000 series.)		C145	1-124-446-11	ELECT 47MF	20% 10V
*****				C146	1-124-589-11	ELECT 47MF	20% 10V
*3-710-317-01	PLATE, GROUND			C147	1-124-443-00	ELECT 100MF	20% 10V
<u>CAPACITOR</u>				C148	1-162-219-31	CERAMIC 68PF	5% 50V
C070	1-124-589-11	ELECT	47MF 20% 10V	C149	1-162-203-31	CERAMIC 15PF	5% 50V
C096	1-161-494-00	CERAMIC	0.022MF 25V	C151	1-162-219-31	CERAMIC 68PF	5% 50V
C097	1-126-233-11	ELECT	22MF 20% 25V	C152	1-162-196-31	CERAMIC 5.6PF	10% 50V
C100	1-124-589-11	ELECT	47MF 20% 10V	C153	1-124-589-11	ELECT 47MF	20% 10V
C101	1-124-446-11	ELECT	47MF 20% 10V	C154	1-162-211-31	CERAMIC 33PF	5% 50V
C102	1-124-477-11	ELECT	47MF 20% 16V	C155	1-124-443-00	ELECT 100MF	20% 10V
C103	1-124-446-11	ELECT	47MF 20% 10V	C157	1-162-291-31	CERAMIC 560PF	10% 50V
C104	1-162-211-31	CERAMIC	33PF 5% 50V	C158	1-124-584-00	ELECT 100MF	20% 10V
C105	1-136-165-00	FILM	0.1MF 5% 50V	C159	1-124-584-00	ELECT 100MF	20% 10V
C106	1-124-446-11	ELECT	47MF 20% 10V	C160	1-162-282-31	CERAMIC 100PF	10% 50V
C107	1-162-215-31	CERAMIC	47PF 5% 50V	C161	1-161-494-00	CERAMIC 0.022MF	25V
C108	1-162-286-31	CERAMIC	220PF 10% 50V	C162	1-126-163-11	ELECT 4.7MF	20% 50V
C109	1-161-375-00	CERAMIC	0.0022MF 20% 16V	C163	1-124-270-11	ELECT 0.47MF	20% 50V
C110	1-162-286-31	CERAMIC	220PF 10% 50V	C164	1-162-198-31	CERAMIC 8.2PF	10% 50V
C111	1-161-379-00	CERAMIC	0.01MF 20% 16V	C165	1-161-494-00	CERAMIC 0.022MF	25V
C112	1-124-925-11	ELECT	2.2MF 20% 50V	C166	1-161-494-00	CERAMIC 0.022MF	25V
C113	1-124-446-11	ELECT	47MF 20% 10V	C167	1-162-215-31	CERAMIC 47PF	5% 50V
C114	1-124-234-00	ELECT	22MF 20% 16V	C168	1-162-207-31	CERAMIC 22PF	5% 50V
C115	1-162-201-31	CERAMIC	12PF 5% 50V	C169	1-161-379-00	CERAMIC 0.01MF	20% 16V
C116	1-162-201-31	CERAMIC	12PF 5% 50V	C170	1-162-282-31	CERAMIC 100PF	10% 50V
C117	1-162-215-31	CERAMIC	47PF 5% 50V	C171	1-162-280-31	CERAMIC 82PF	10% 50V
C118	1-162-286-31	CERAMIC	220PF 10% 50V	C172	1-126-160-11	ELECT 1MF	20% 50V
C119	1-130-485-00	MYLAR	0.015MF 5% 50V	C173	1-161-379-00	CERAMIC 0.01MF	20% 16V
C120	1-124-465-00	ELECT	0.47MF 20% 50V	C174	1-124-589-11	ELECT 47MF	20% 10V
C121	1-130-469-00	MYLAR	680PF 5% 50V	C176	1-126-101-11	ELECT 100MF	20% 16V
C122	1-162-288-31	CERAMIC	330PF 10% 50V	C177	1-124-443-00	ELECT 100MF	20% 10V
C123	1-162-288-31	CERAMIC	330PF 10% 50V	C178	1-161-379-00	CERAMIC 0.01MF	20% 16V
C124	1-136-164-00	FILM	0.082MF 5% 50V	C179	1-161-379-00	CERAMIC 0.01MF	20% 16V
C125	1-161-379-00	CERAMIC	0.01MF 20% 16V	C180	1-126-160-11	ELECT 1MF	20% 50V
C126	1-161-494-00	CERAMIC	0.022MF 25V	C181	1-126-233-11	ELECT 22MF	20% 25V
C127	1-126-233-11	ELECT	22MF 20% 25V	C194	1-124-589-11	ELECT 47MF	20% 10V
C128	1-161-021-11	CERAMIC	0.047MF 10% 25V	C195	1-124-443-00	ELECT 100MF	20% 10V
C129	1-162-203-31	CERAMIC	15PF 5% 50V	C197	1-124-584-00	ELECT 100MF	20% 10V
C130	1-162-207-31	CERAMIC	22PF 5% 50V	C198	1-161-494-00	CERAMIC 0.022MF	25V
C131	1-161-494-00	CERAMIC	0.022MF 25V	C200	1-161-379-00	CERAMIC 0.01MF	20% 16V
C132	1-124-446-11	ELECT	47MF 20% 10V	C201	1-162-211-31	CERAMIC 33PF	5% 50V
C133	1-161-021-11	CERAMIC	0.047MF 10% 25V	C202	1-162-286-31	CERAMIC 220PF	10% 50V
C134	1-131-381-00	TANTALUM	47MF 20% 10V	C203	1-162-286-31	CERAMIC 220PF	10% 50V
C136	1-130-491-00	MYLAR	0.047MF 5% 50V	C204	1-124-589-11	ELECT 47MF	20% 10V
C137	1-124-477-11	ELECT	47MF 20% 16V	C205	1-130-479-00	MYLAR 0.0047MF	5% 50V
C138	1-124-446-11	ELECT	47MF 20% 10V	C206	1-162-291-31	CERAMIC 560PF	10% 50V
C139	1-162-211-31	CERAMIC	33PF 5% 50V	C207	1-136-165-00	FILM 0.1MF	5% 50V
C140	1-162-211-31	CERAMIC	33PF 5% 50V	C208	1-162-282-31	CERAMIC 100PF	10% 50V
C141	1-126-176-11	ELECT	220MF 20% 10V	C209	1-162-215-31	CERAMIC 47PF	5% 50V
C142	1-124-499-11	ELECT	1MF 20% 50V	C210	1-162-215-31	CERAMIC 47PF	5% 50V
C143	1-124-446-11	ELECT	47MF 20% 10V	C211	1-124-446-11	ELECT 47MF	20% 10V
C144	1-124-446-11	ELECT	47MF 20% 10V	C212	1-130-483-00	MYLAR 0.01MF	5% 50V
				C213	1-124-446-11	ELECT 47MF	20% 10V
				C214	1-130-483-00	MYLAR 0.01MF	5% 50V

VP-11

<u>Ref.No</u>	<u>Part No.</u>	<u>Description</u>	<u>Remark</u>	<u>Ref.No</u>	<u>Part No.</u>	<u>Description</u>	<u>Remark</u>
<u>DIODE</u>							
D100	8-719-911-19	DIODE 1SS119		IC302	8-759-902-21	IC SN74LS221N	
D101	8-719-911-19	DIODE 1SS119		IC303	8-759-202-11	IC TC74HCOOP	
D102	8-719-911-19	DIODE 1SS119		IC304	8-759-208-10	IC TC4053BPHB	
D110	8-719-911-19	DIODE 1SS119		IC305	8-759-902-21	IC SN74LS221N	
D111	8-719-911-19	DIODE 1SS119		IC500	8-752-030-75	IC V7020	
D112	8-719-911-19	DIODE 1SS119		IC501	8-759-208-10	IC TC4053BPHB	
D113	8-719-911-19	DIODE 1SS119		IC600	8-759-605-84	IC CXA1145P	
D300	8-719-911-19	DIODE 1SS119		IC601	8-759-710-58	IC NJM2244D	
D301	8-719-907-19	DIODE FC52M-5		IC602	8-759-030-67	IC MC14576	
D500	8-719-911-19	DIODE 1SS119		IC603	8-759-030-67	IC MC14576	
D501	8-719-911-19	DIODE 1SS119		<u>COIL</u>			
D502	8-719-911-19	DIODE 1SS119		L100	1-408-416-00	INDUCTOR	39UH
D503	8-719-911-19	DIODE 1SS119		L101	1-410-336-11	INDUCTOR	220UH
<u>DELAY LINE</u>				L102	1-408-422-00	INDUCTOR	120UH
DL500	1-415-122-91	DELAY LINE, 1H (PAL)		L105	1-408-422-00	INDUCTOR	120UH
DL600	1-415-238-00	DELAY LINE		L106	1-408-422-00	INDUCTOR	120UH
<u>FERRITE BEAD</u>				L108	1-410-515-11	INDUCTOR	33UH
FB601	1-543-236-11	BEAD, FERRITE		L113	1-408-416-00	INDUCTOR	39UH
FB602	1-543-236-11	BEAD, FERRITE		L114	1-410-336-11	INDUCTOR	220UH
FB603	1-543-236-11	BEAD, FERRITE		L116	1-408-409-00	INDUCTOR	10UH
FB604	1-543-236-11	BEAD, FERRITE		L117	1-408-409-00	INDUCTOR	10UH
FB605	1-543-236-11	BEAD, FERRITE		L118	1-408-409-00	INDUCTOR	10UH
FB606	1-543-236-11	BEAD, FERRITE		L120	1-408-422-00	INDUCTOR	120UH
FB607	1-410-396-41	INDUCTOR	0.45UH	L121	1-408-422-00	INDUCTOR	120UH
FB608	1-410-396-41	INDUCTOR	0.45UH	L122	1-408-422-00	INDUCTOR	120UH
<u>FILTER</u>				L123	1-408-422-00	INDUCTOR	120UH
FL200	1-567-657-11	FILTER, CERAMIC (SFS-MC TYPE)		L124	1-408-416-00	INDUCTOR	39UH
FL500	1-235-833-11	YC MODULE		L125	1-408-414-00	INDUCTOR	27UH
FL600	1-409-447-11	COIL, TRAP		L126	1-408-418-00	INDUCTOR	56UH
FL601	1-409-447-11	COIL, TRAP		L127	1-408-412-00	INDUCTOR	18UH
FL602	1-409-447-11	COIL, TRAP		L132	1-408-422-00	INDUCTOR	120UH
FL603	1-235-181-00	FILTER, BAND PASS		L133	1-408-409-00	INDUCTOR	10UH
FL604	1-235-181-00	FILTER, BAND PASS		L200	1-408-409-00	INDUCTOR	10UH
<u>IC</u>				L201	1-408-409-00	INDUCTOR	10UH
IC07	8-759-278-09	IC TA78L009AP		L202	1-408-409-00	INDUCTOR	10UH
IC100	8-752-006-10	IC CX20061		L203	1-408-412-00	INDUCTOR	18UH
IC101	8-752-321-89	IC CXL5003P		L300	1-408-416-00	INDUCTOR	39UH
IC102	8-759-912-64	IC PA0009		L301	1-408-409-00	INDUCTOR	10UH
IC103	8-759-901-23	IC SN74LS123N		L302	1-410-520-11	INDUCTOR	82UH
IC104	8-752-320-31	IC CXL1004P		L500	1-410-507-11	INDUCTOR	6.8UH
IC105	8-759-912-67	IC PA9003		L501	1-408-422-00	INDUCTOR	120UH
IC106	8-759-200-60	IC TA7060AP		L502	1-408-422-00	INDUCTOR	120UH
IC107	8-759-208-08	IC TC4052BPHB		L503	1-408-421-00	INDUCTOR	100UH
IC108	8-759-950-07	IC SN75107BN		L504	1-410-506-11	INDUCTOR	5.6UH
IC200	8-752-030-44	IC CXA1018S		L508	1-408-409-00	INDUCTOR	10UH
IC300	8-759-938-56	IC MB88201H-523M		L509	1-408-409-00	INDUCTOR	10UH
IC301	8-759-207-28	IC TC9015P		L600	1-408-422-00	INDUCTOR	120UH
				L602	1-408-416-00	INDUCTOR	39UH
				L603	1-408-422-00	INDUCTOR	120UH
				L604	1-408-422-00	INDUCTOR	120UH
				L605	1-408-421-00	INDUCTOR	100UH
				L606	1-408-409-00	INDUCTOR	10UH

When indicating parts by reference number, please include the board name.

Ref.No	Part No.	Description	Remark	Ref.No	Part No.	Description	Remark
L607	1-408-422-00	INDUCTOR 120UH		R102	1-249-429-11	CARBON 10K 5%	1/4W
		VARIABLE COIL		R103	1-249-421-11	CARBON 2.2K 5%	1/4W
				R104	1-247-903-00	CARBON 1M 5%	1/4W
LV500	1-415-651-11	COIL (DELAY ADJUSTMENT)		R105	1-249-429-11	CARBON 10K 5%	1/4W
		TRANSISTOR		R106	1-249-411-11	CARBON 330 5%	1/4W
Q100	8-729-178-54	TRANSISTOR 2SC2785		R107	1-249-417-11	CARBON 1K 5%	1/4W
Q101	8-729-178-54	TRANSISTOR 2SC2785		R108	1-249-421-11	CARBON 2.2K 5%	1/4W
Q102	8-729-178-54	TRANSISTOR 2SC2785		R109	1-249-421-11	CARBON 2.2K 5%	1/4W
Q103	8-729-178-54	TRANSISTOR 2SC2785		R110	1-249-421-11	CARBON 2.2K 5%	1/4W
Q104	8-729-173-38	TRANSISTOR 2SA733-K		R113	1-249-405-11	CARBON 100 5%	1/4W
Q107	8-729-218-43	TRANSISTOR 2SK184-GR		R114	1-249-417-11	CARBON 1K 5%	1/4W
Q110	8-729-178-54	TRANSISTOR 2SC2785		R115	1-249-427-11	CARBON 6.8K 5%	1/4W
Q113	8-729-178-54	TRANSISTOR 2SC2785		R116	1-249-441-11	CARBON 100K 5%	1/4W
Q114	8-729-178-54	TRANSISTOR 2SC2785		R117	1-249-426-11	CARBON 5.6K 5%	1/4W
Q115	8-729-178-54	TRANSISTOR 2SC2785		R119	1-249-426-11	CARBON 5.6K 5%	1/4W
Q119	8-729-178-54	TRANSISTOR 2SC2785		R120	1-249-437-11	CARBON 47K 5%	1/4W
Q120	8-729-178-54	TRANSISTOR 2SC2785		R121	1-249-438-11	CARBON 56K 5%	1/4W
Q133	8-729-178-54	TRANSISTOR 2SC2785		R122	1-249-430-11	CARBON 12K 5%	1/4W
Q134	8-729-173-38	TRANSISTOR 2SA733-K		R123	1-249-421-11	CARBON 2.2K 5%	1/4W
Q135	8-729-178-54	TRANSISTOR 2SC2785		R124	1-249-441-11	CARBON 100K 5%	1/4W
Q136	8-729-173-38	TRANSISTOR 2SA733-K		R125	1-249-425-11	CARBON 4.7K 5%	1/4W
Q137	8-729-103-19	TRANSISTOR 2SA1206-K1		R126	1-249-405-11	CARBON 100 5%	1/4W
Q138	8-729-190-12	TRANSISTOR 2SC2901		R127	1-249-423-11	CARBON 3.3K 5%	1/4W
Q139	8-729-173-38	TRANSISTOR 2SA733-K		R128	1-249-420-11	CARBON 1.8K 5%	1/4W
Q140	8-729-178-54	TRANSISTOR 2SC2785		R129	1-249-420-11	CARBON 1.8K 5%	1/4W
Q141	8-729-178-54	TRANSISTOR 2SC2785		R130	1-249-413-11	CARBON 470 5%	1/4W
Q142	8-729-173-38	TRANSISTOR 2SA733-K		R131	1-249-419-11	CARBON 1.5K 5%	1/4W
Q143	8-729-173-38	TRANSISTOR 2SA733-K		R132	1-249-417-11	CARBON 1K 5%	1/4W
Q144	8-729-178-54	TRANSISTOR 2SC2785		R133	1-249-417-11	CARBON 1K 5%	1/4W
Q200	8-729-900-89	TRANSISTOR DTC144ES		R134	1-249-415-11	CARBON 680 5%	1/4W
Q201	8-729-178-54	TRANSISTOR 2SC2785		R135	1-249-417-11	CARBON 1K 5%	1/4W
Q202	8-729-178-54	TRANSISTOR 2SC2785		R136	1-249-417-11	CARBON 1K 5%	1/4W
Q301	8-729-900-89	TRANSISTOR DTC144ES		R137	1-249-417-11	CARBON 1K 5%	1/4W
Q302	8-729-900-89	TRANSISTOR DTC144ES		R138	1-247-903-00	CARBON 1M 5%	1/4W
Q303	8-729-900-89	TRANSISTOR DTC144ES		R140	1-249-421-11	CARBON 2.2K 5%	1/4W
Q500	8-729-178-54	TRANSISTOR 2SC2785		R141	1-249-417-11	CARBON 1K 5%	1/4W
Q501	8-729-178-54	TRANSISTOR 2SC2785		R142	1-249-417-11	CARBON 1K 5%	1/4W
Q502	8-729-173-38	TRANSISTOR 2SA733-K		R143	1-249-418-11	CARBON 1.2K 5%	1/4W
Q600	8-729-178-54	TRANSISTOR 2SC2785		R144	1-249-419-11	CARBON 1.5K 5%	1/4W
Q601	8-729-173-38	TRANSISTOR 2SA733-K		R146	1-249-417-11	CARBON 1K 5%	1/4W
Q602	8-729-178-54	TRANSISTOR 2SC2785		R147	1-249-417-11	CARBON 1K 5%	1/4W
Q603	8-729-173-38	TRANSISTOR 2SA733-K		R148	1-249-417-11	CARBON 1K 5%	1/4W
Q604	8-729-178-54	TRANSISTOR 2SC2785		R149	1-249-404-00	CARBON 82 5%	1/4W
Q605	8-729-173-38	TRANSISTOR 2SA733-K		R150	1-249-417-11	CARBON 1K 5%	1/4W
Q606	8-729-178-54	TRANSISTOR 2SC2785		R151	1-249-405-11	CARBON 100 5%	1/4W
Q607	8-729-178-54	TRANSISTOR 2SC2785		R152	1-249-429-11	CARBON 10K 5%	1/4W
Q608	8-729-178-54	TRANSISTOR 2SC2785		R153	1-249-413-11	CARBON 470 5%	1/4W
Q609	8-729-178-54	TRANSISTOR 2SC2785		R154	1-249-413-11	CARBON 470 5%	1/4W
		RESISTOR		R155	1-249-423-11	CARBON 3.3K 5%	1/4W
R100	1-249-425-11	CARBON 4.7K 5%	1/4W	R156	1-249-413-11	CARBON 470 5%	1/4W
				R157	1-249-424-11	CARBON 3.9K 5%	1/4W
				R158	1-249-441-11	CARBON 100K 5%	1/4W
				R159	1-249-417-11	CARBON 1K 5%	1/4W

When indicating parts by reference number, please include the board name.

VP-11

Ref.No	Part No.	Description	Remark	Ref.No	Part No.	Description	Remark
R160	1-249-417-11	CARBON	1K 5% 1/4W	R308	1-249-431-11	CARBON	15K 5% 1/4W
R161	1-249-421-11	CARBON	2.2K 5% 1/4W	R309	1-247-903-00	CARBON	1M 5% 1/4W
R162	1-249-417-11	CARBON	1K 5% 1/4W	R310	1-249-417-11	CARBON	1K 5% 1/4W
R163	1-249-417-11	CARBON	1K 5% 1/4W	R311	1-249-417-11	CARBON	1K 5% 1/4W
R164	1-249-437-11	CARBON	47K 5% 1/4W	R312	1-249-417-11	CARBON	1K 5% 1/4W
R165	1-249-433-11	CARBON	22K 5% 1/4W	R313	1-249-433-11	CARBON	22K 5% 1/4W
R166	1-249-421-11	CARBON	2.2K 5% 1/4W	R314	1-247-887-00	CARBON	220K 5% 1/4W
R167	1-249-401-11	CARBON	47 5% 1/4W	R315	1-249-419-11	CARBON	1.5K 5% 1/4W
R168	1-249-429-11	CARBON	10K 5% 1/4W	R316	1-249-410-11	CARBON	270 5% 1/4W
R169	1-249-413-11	CARBON	470 5% 1/4W	R317	1-249-417-11	CARBON	1K 5% 1/4W
R170	1-249-417-11	CARBON	1K 5% 1/4W	R318	1-249-417-11	CARBON	1K 5% 1/4W
R171	1-249-429-11	CARBON	10K 5% 1/4W	R400	1-249-425-11	CARBON	4.7K 5% 1/4W
R172	1-249-409-11	CARBON	220 5% 1/4W	R401	1-249-417-11	CARBON	1K 5% 1/4W
R173	1-249-409-11	CARBON	220 5% 1/4W	R402	1-249-417-11	CARBON	1K 5% 1/4W
R175	1-249-418-11	CARBON	1.2K 5% 1/4W	R403	1-249-422-11	CARBON	2.7K 5% 1/4W
R177	1-249-417-11	CARBON	1K 5% 1/4W	R404	1-249-422-11	CARBON	2.7K 5% 1/4W
R198	1-249-423-11	CARBON	3.3K 5% 1/4W	R405	1-249-417-11	CARBON	1K 5% 1/4W
R200	1-249-423-11	CARBON	3.3K 5% 1/4W	R406	1-249-417-11	CARBON	1K 5% 1/4W
R201	1-249-441-11	CARBON	100K 5% 1/4W	R500	1-249-417-11	CARBON	1K 5% 1/4W
R202	1-249-441-11	CARBON	100K 5% 1/4W	R501	1-249-413-11	CARBON	470 5% 1/4W
R203	1-247-881-00	CARBON	120K 5% 1/4W	R502	1-249-417-11	CARBON	1K 5% 1/4W
R204	1-247-895-00	CARBON	470K 5% 1/4W	R503	1-249-417-11	CARBON	1K 5% 1/4W
R205	1-249-430-11	CARBON	12K 5% 1/4W	R504	1-249-417-11	CARBON	1K 5% 1/4W
R206	1-249-437-11	CARBON	47K 5% 1/4W	R506	1-247-893-11	CARBON	390K 5% 1/4W
R207	1-249-441-11	CARBON	100K 5% 1/4W	R507	1-247-885-00	CARBON	180K 5% 1/4W
R208	1-249-436-11	CARBON	39K 5% 1/4W	R508	1-249-416-11	CARBON	820 5% 1/4W
R209	1-249-441-11	CARBON	100K 5% 1/4W	R509	1-249-420-11	CARBON	1.8K 5% 1/4W
R210	1-249-440-11	CARBON	82K 5% 1/4W	R510	1-249-412-11	CARBON	390 5% 1/4W
R211	1-247-895-00	CARBON	470K 5% 1/4W	R511	1-249-412-11	CARBON	390 5% 1/4W
R212	1-249-421-11	CARBON	2.2K 5% 1/4W	R512	1-249-421-11	CARBON	2.2K 5% 1/4W
R213	1-249-441-11	CARBON	100K 5% 1/4W	R513	1-249-427-11	CARBON	6.8K 5% 1/4W
R214	1-247-895-00	CARBON	470K 5% 1/4W	R514	1-249-431-11	CARBON	15K 5% 1/4W
R215	1-249-434-11	CARBON	27K 5% 1/4W	R515	1-249-413-11	CARBON	470 5% 1/4W
R216	1-249-434-11	CARBON	27K 5% 1/4W	R516	1-249-421-11	CARBON	2.2K 5% 1/4W
R217	1-249-441-11	CARBON	100K 5% 1/4W	R517	1-249-426-11	CARBON	5.6K 5% 1/4W
R218	1-249-437-11	CARBON	47K 5% 1/4W	R518	1-249-431-11	CARBON	15K 5% 1/4W
R219	1-247-895-00	CARBON	470K 5% 1/4W	R519	1-249-418-11	CARBON	1.2K 5% 1/4W
R220	1-249-417-11	CARBON	1K 5% 1/4W	R520	1-249-409-11	CARBON	220 5% 1/4W
R221	1-249-404-00	CARBON	82 5% 1/4W	R600	1-249-417-11	CARBON	1K 5% 1/4W
R222	1-247-891-00	CARBON	330K 5% 1/4W	R601	1-249-411-11	CARBON	330 5% 1/4W
R223	1-249-435-11	CARBON	33K 5% 1/4W	R602	1-249-417-11	CARBON	1K 5% 1/4W
R224	1-249-438-11	CARBON	56K 5% 1/4W	R603	1-249-423-11	CARBON	3.3K 5% 1/4W
R225	1-249-417-11	CARBON	1K 5% 1/4W	R604	1-249-417-11	CARBON	1K 5% 1/4W
R226	1-249-421-11	CARBON	2.2K 5% 1/4W	R605	1-249-423-11	CARBON	3.3K 5% 1/4W
R227	1-249-433-11	CARBON	22K 5% 1/4W	R606	1-249-411-11	CARBON	330 5% 1/4W
R300	1-247-903-00	CARBON	1M 5% 1/4W	R607	1-249-417-11	CARBON	1K 5% 1/4W
R301	1-249-419-11	CARBON	1.5K 5% 1/4W	R608	1-249-417-11	CARBON	1K 5% 1/4W
R302	1-249-441-11	CARBON	100K 5% 1/4W	R609	1-249-423-11	CARBON	3.3K 5% 1/4W
R303	1-249-419-11	CARBON	1.5K 5% 1/4W	R610	1-249-411-11	CARBON	330 5% 1/4W
R304	1-215-445-00	METAL	10K 1% 1/6W	R611	1-249-417-11	CARBON	1K 5% 1/4W
R305	1-215-457-00	METAL	33K 1% 1/6W	R613	1-249-431-11	CARBON	15K 5% 1/4W
R306	1-249-438-11	CARBON	56K 5% 1/4W	R614	1-249-421-11	CARBON	2.2K 5% 1/4W
R307	1-249-410-11	CARBON	270 5% 1/4W	R615	1-249-417-11	CARBON	1K 5% 1/4W

When indicating parts by reference number, please include the board name.

Ref.No	Part No.	Description	Remark	Ref.No	Part No.	Description	Remark
R616	1-249-417-11	CARBON	1K 5% 1/4W	X300	1-567-344-21	VIBRATOR, CRYSTAL (VCO) 17.734475MHz	
R617	1-249-435-11	CARBON	33K 5% 1/4W	X500	1-527-345-61	OSCILLATOR, CRYSTAL 4.43MHz	
R618	1-249-437-11	CARBON	47K 5% 1/4W	*****			
R619	1-249-417-11	CARBON	1K 5% 1/4W				
R620	1-249-429-11	CARBON	10K 5% 1/4W				
R621	1-249-419-11	CARBON	1.5K 5% 1/4W				
R622	1-249-417-11	CARBON	1K 5% 1/4W				
R623	1-249-417-11	CARBON	1K 5% 1/4W				
R624	1-249-417-11	CARBON	1K 5% 1/4W				
R625	1-249-417-11	CARBON	1K 5% 1/4W				
R626	1-215-455-00	METAL	27K 1% 1/6W				
R627	1-249-429-11	CARBON	10K 5% 1/4W				
R628	1-249-441-11	CARBON	100K 5% 1/4W				
R629	1-215-394-00	METAL	75 1% 1/6W				
R630	1-215-394-00	METAL	75 1% 1/6W				
R631	1-215-394-00	METAL	75 1% 1/6W				
R632	1-215-394-00	METAL	75 1% 1/6W				
R633	1-215-394-00	METAL	75 1% 1/6W				
R634	1-249-407-11	CARBON	150 5% 1/4W				
R635	1-249-407-11	CARBON	150 5% 1/4W				
R637	1-249-413-11	CARBON	470 5% 1/4W				
<u>VARIABLE RESISTOR</u>							
RV100	1-228-991-00	RES, ADJ, CARBON	2.2K				
RV101	1-228-991-00	RES, ADJ, CARBON	2.2K				
RV102	1-228-994-00	RES, ADJ, CARBON	10K				
RV103	1-228-991-00	RES, ADJ, CARBON	2.2K				
RV200	1-228-996-00	RES, ADJ, CARBON	47K				
RV201	1-228-996-00	RES, ADJ, CARBON	47K				
RV300	1-228-995-00	RES, ADJ, METAL GLAZE	22K				
RV301	1-228-995-00	RES, ADJ, METAL GLAZE	22K				
RV302	1-228-991-00	RES, ADJ, CARBON	2.2K				
RV500	1-228-992-11	RES, ADJ, CARBON	3.3K				
RV501	1-228-990-00	RES, ADJ, CARBON	1K				
RV502	1-249-409-11	CARBON	220 5% 1/4W				
RV503	1-228-991-00	RES, ADJ, CARBON	2.2K				
RV504	1-228-991-00	RES, ADJ, CARBON	2.2K				
RV505	1-228-995-00	RES, ADJ, CARBON	22K				
RV506	1-228-989-00	RES, ADJ, CARBON	470				
RV600	1-228-990-00	RES, ADJ, CARBON	1K				
RV601	1-228-990-00	RES, ADJ, CARBON	1K				
RV602	1-228-993-00	RES, ADJ, CARBON	4.7K				
RV603	1-228-990-00	RES, ADJ, CARBON	1K				
RV604	1-228-991-00	RES, ADJ, CARBON	2.2K				
RV605	1-228-991-00	RES, ADJ, CARBON	2.2K				
RV606	1-228-991-00	RES, ADJ, CARBON	2.2K				
<u>SWITCH</u>							
SW600	1-554-377-00	SWITCH, SLIDE (VIDEO OUTPUT SELECTOR)					
<u>CRYSTAL</u>							
X100	1-567-652-11	VIBRATOR, CRYSTAL	13.300856MHz				

When indicating parts by reference number, please include the board name.

SECTION 8 ELECTRICAL ADJUSTMENTS

8-5-3. DOC Video Level Adjustment

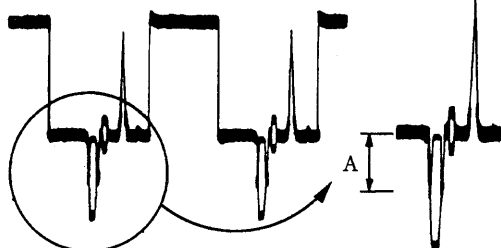
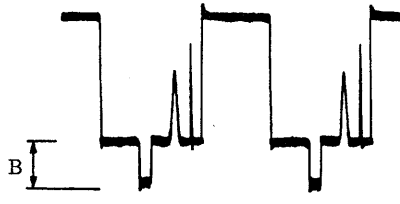
Conditions	Specifications	Adjustment
<ul style="list-style-type: none"> Search for chapter 15 of a Ref. disc. 	<p>TP101/VP-11</p>  <p>TP102/VP11</p>  <p style="text-align: center;">Make A=B (Equalize SYNC levels)</p>	RV100/VP-11

8-5-4. CCD Bias Adjustment

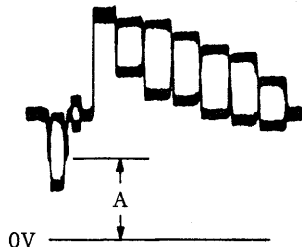
Conditions	Specifications	Adjustment
<ul style="list-style-type: none"> Search for chapter 22 of a Ref. disc. (color bar) 	<p>TP103/VP-11</p>  <p style="text-align: center;">A = 2.65 ± 0.1V</p>	RV102/VP-11

8-5-5. Direct Video Level Adjustment (1)

Conditions	Specifications	Adjustment
<ul style="list-style-type: none"> Search for chapter 22 of a Ref. disc. (color bar) Normal play mode or STILL mode. 	<p>IC105 pin ① /VP-11</p>  <p style="text-align: center;">A = 2.3Vp-p ± 0.1V</p>	RV103/VP-11

8-5-5. Direct Video Level Adjustment (2)

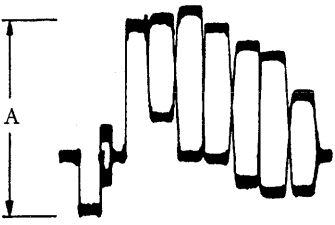
Conditions	Specifications	Adjustment
<ul style="list-style-type: none"> • Search for chapter 22 of a Ref. disc. (Color bar) • Normal play mode. • Put on SW600. <p>Note : Perform this adjustment after adjusting Direct Video Level Adjustment (1).</p>	<p>VIDEO OUT CONNECTOR (BNC) (75 Ω Terminated)</p>  <p>$A = 1.0V_{p-p} \pm 0.05V$</p>	RV602/VP-11

8-5-6. TBC Centering Adjustment

Conditions	Specifications	Adjustment
<ul style="list-style-type: none"> • Search for chapter 16 of a Ref. disc. • Short-circuit TP203 and TP204. 	<p>TP101/VP-11</p>  <p>TP104/VP-11</p> <p>(CHOP mode)</p> <p>$A = 11 \pm 0.5 \mu S$</p>	RV101/VP-11

8-5-7. TBC 1/2 H Rejecter Adjustment

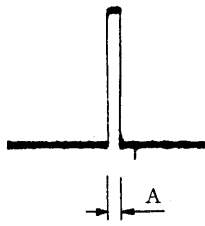
Conditions	Specifications	Adjustment
<ul style="list-style-type: none"> • Playing back a Ref. disc. 	<p>TP105/VP-11</p>  <p>$A = 4 \pm 0.2 \mu S$</p>	RV200/VP-11

8-5-8. CBH Position Adjustment

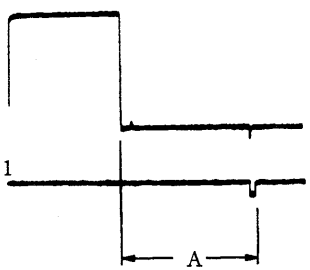
Conditions	Specifications	Adjustment
<ul style="list-style-type: none"> Playing back a Ref. disc. 	TP105/VP-11  $A = 5.3 \pm 0.3 \mu S$ (Center of shaking)	RV201/VP-11

8-5-9. B. B SC Adjustment

Conditions	Specifications	Adjustment
<ul style="list-style-type: none"> Power ON state. 	TP301/VP-11 $4,433,619 \pm 5 Hz$	CV300/VP-11

8-5-10. B. B H Sync Adjustment

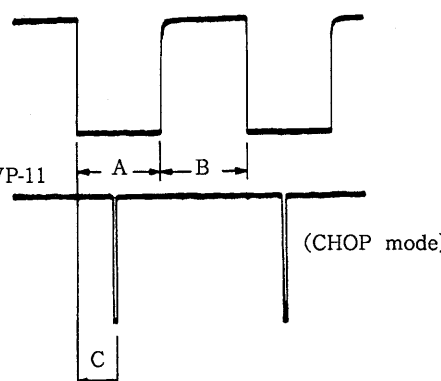
Conditions	Specifications	Adjustment
<ul style="list-style-type: none"> Power ON state. 	CN3 pin ②/VP-11  $A = B$ $C = 14 \pm 1 \mu S$	Duty Adjustment RV301/VP-11 Phase Adjustment RV300/VP-11

8-5-11. Burst Flag Position Adjustment

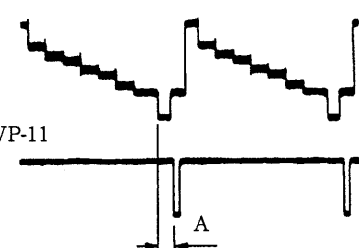
Conditions	Specifications	Adjustment
<ul style="list-style-type: none"> FWD normal play or STILL mode. 	TP501/VP-11  $A = 5.6 \pm 0.1 \mu S$	RV505/VP-11

8-5-12. Decoder Y Gain Adjustment

Conditions	Specifications	Adjustment
<ul style="list-style-type: none"> Search for chapter 15 of a Ref. disc. 	TP600/VP-11  $A = 1.1 \begin{matrix} +0.1 \\ -0 \end{matrix} \text{ V}_{p-p}$	RV501/VP-11

8-5-13. Chroma Input Level Adjustment

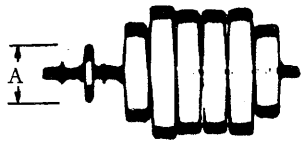
Conditions	Specifications	Adjustment
<ul style="list-style-type: none"> Search for chapter 22 of a Ref. disc. (color bar) 	TP502/VP-11  $A = 143 \pm 10 \text{ mV}$	RV500/VP-11

8-5-14. Decoder SC Level, Frequency Adjustment

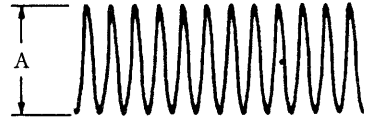
Conditions	Specifications	Adjustment
<ul style="list-style-type: none"> Search for chapter 22 of a Ref. disc. (color bar) Normal play mode. Apply +5V $\begin{pmatrix} +0V \\ -2V \end{pmatrix}$ to TP503. 	TP504/VP-11  $A = 400 \text{ mV} \pm 20 \text{ mV}$ $F_{sc} = 4,433,619 \pm 20 \text{ Hz}$	Level RV506/VP-11 Frequency CV500/VP-11

8-5-15. Encoder Burst Level Adjustment

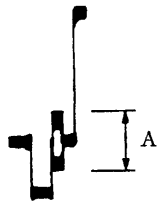
Conditions	Specifications	Adjustment
<ul style="list-style-type: none"> Search for chapter 16 of a Ref. disc. FWD Normal play mode. SW600 ON/OFF 	Video out connector (75 Ω terminated)  Make A levels on SW600 ON and on SW600 OFF equal.	RV600/VP-11

VP-11 BOARD (COMPONENT SIDE)

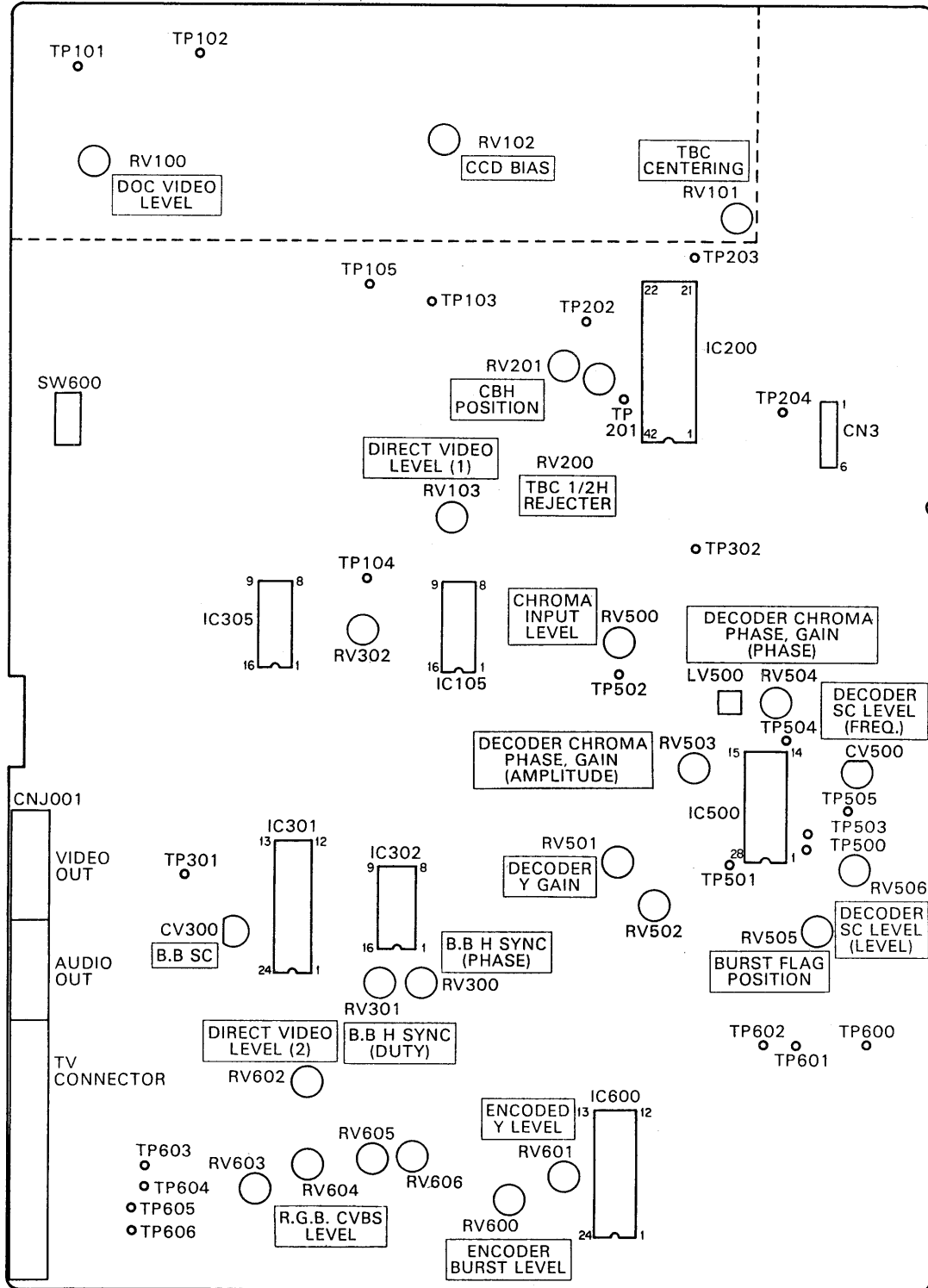

—Continued on next page—



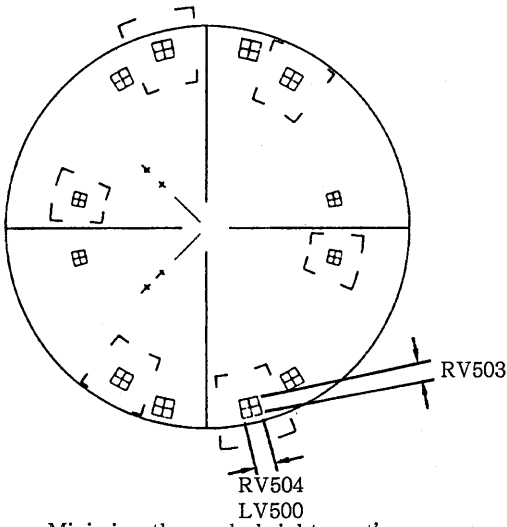

8-5-16. Decoder Chroma Phase, Gain Adjustment

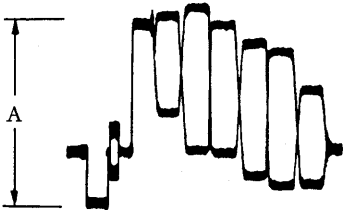
Conditions	Specifications	Adjustment
<ul style="list-style-type: none"> • Search for chapter 16 of a Ref. disc. (color bar) • FWD normal play. • Put off SW600. • Equalize the burst level by adjusting GAIN volume on the vectorscope (75%). 	 <p data-bbox="575 842 923 902">Minimize the each bright spot's spread and get it into □.</p>	<p data-bbox="1075 318 1353 345">Amplitude : RV503/VP-11</p> <p data-bbox="1075 349 1305 376">Phase : RV504/VP-11</p> <p data-bbox="1154 380 1302 407">LV500/VP-11</p>

8-5-17. Encoded Y Level Adjustment

Conditions	Specifications	Adjustment
<ul style="list-style-type: none"> • Search for chapter 22 of a Ref. disc. (color bar) • Normal play mode. • Put off SW600. 	<p data-bbox="461 1055 854 1119">Video out connector (BNC) (75 Ω terminated)</p>  <p data-bbox="679 1380 825 1406">A = 1.0 ± 0.05V</p>	<p data-bbox="1075 1055 1225 1081">RV601/VP-11</p>

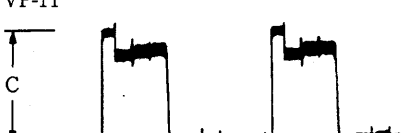
8-5-18. R. G. B. CVBS Level Adjustment

Conditions	Specifications	Adjustment
<ul style="list-style-type: none"> • Search for chapter 22 of a Ref. disc. (color bar) • Normal play mode. • 21pin (CENELEC standard) connector should be terminated by the specified impedance. 	<p>TP603/VP-11</p>  <p>TP604/VP-11</p>  <p>TP605/VP-11</p>  <p>TP606/VP-11</p>  <p> $A = 1.0 \pm 0.05V_{p-p}$ $B = C = D (= 0.7V \pm 0.05V_{p-p})$ The difference between B, C, and D should be controlled within 3%. </p>	<p>A : RV603/VP-11</p> <p>B : RV604/VP-11</p> <p>C : RV605/VP-11</p> <p>D : RV606/VP-11</p>

8-5-19. Skew Servo Adjustment

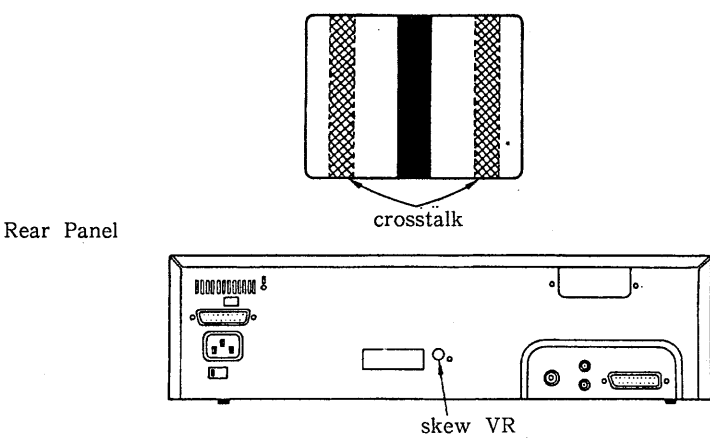
Conditions	Specifications
<ul style="list-style-type: none"> • Search for frame 17,264 of a Ref. disc. (STILL mode) 	<p>Remove the blind lid on the rear panel, and adjust a skew VR on the optical block ass'y so that the left and right sides crosstalk is not appeared on the monitor picture.</p>  <p>Rear Panel</p> <p>skew VR</p>

LDP-1600P

SONY® SERVICE MANUAL

AEP Model
UK Model

SUPPLEMENT-1

File this supplement-1 with the service manual.

Subject : SECTION 5 EXPLODED VIEWS Additions

 : Additions

20

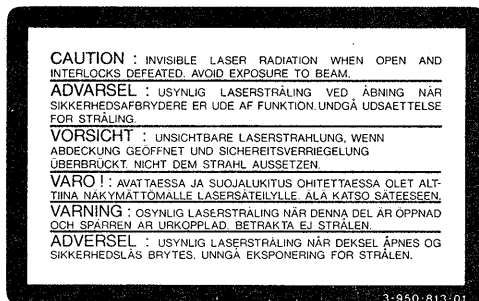

21

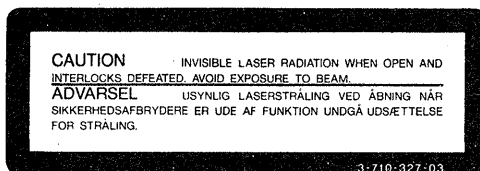

22

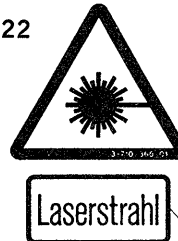

23

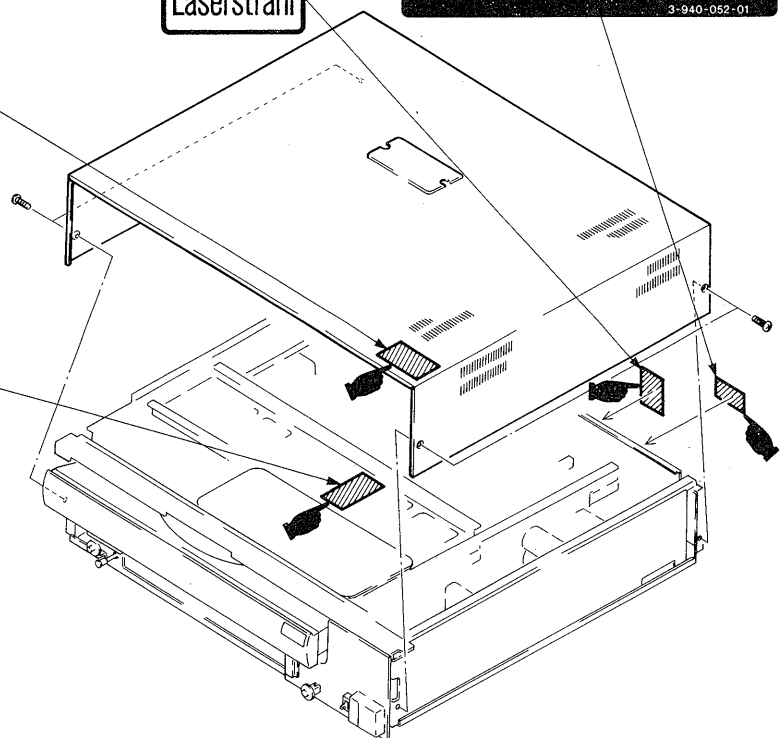
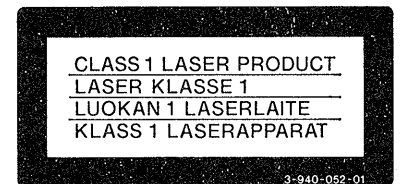

Ref. No.	Part No.	Description	Remark
20	3-950-813-01	LASER CAUTION LABEL	
21	3-710-327-03	LASER CAUTION LABEL	
22	3-710-365-01	LASER CAUTION LABEL	
23	3-940-052-01	LASER CLASS (1) LABEL	