

CD CDV LD Player

Operating Instructions

EN

MDP-550

WARNING

To prevent fire or shock hazard, do not expose the unit to rain or moisture.

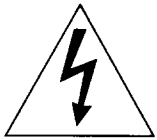
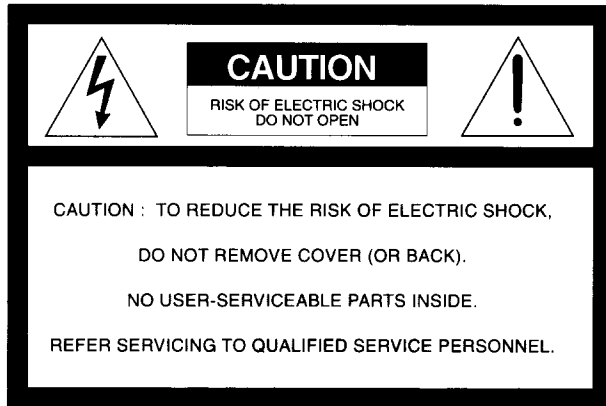

This symbol is intended to alert the user to the presence of uninsulated "dangerous voltage" within the product's enclosure that may be of sufficient magnitude to constitute a risk of electric shock to persons.



This symbol is intended to alert the user to the presence of important operating and maintenance (servicing) instructions in the literature accompanying the appliance.

CAUTION

To prevent electric shock, do not use this polarized AC plug with an extension cord, receptacle or other outlet unless the blades can be fully inserted to prevent blade exposure.

CAUTION

The use of optical instruments with this product will increase eye hazard. As the laser beam used in this player is harmful to the eyes, do not attempt to disassemble the cabinet. Refer servicing to qualified personnel only.

Precautions

Safety

- Operate the unit only on 120V AC, 60 Hz.
- If anything falls into the cabinet, unplug the unit and have it checked by qualified personnel before operating it any further.
- One blade of the plug is wider than the other for safety reasons and will fit into the power outlet only one way. If you are unable to insert the plug fully into the outlet, contact your Sony dealer.
- Unplug the unit from the wall outlet if you do not intend to use it for an extended period of time. To disconnect the cord, pull it out by the plug, never by the cord.

Installing

- Allow adequate air circulation to prevent internal heat buildup.
- Do not place the unit on surfaces (rugs, blankets, etc.) or near materials (curtains, draperies) that may block the space under the unit.
- Do not install the unit near heat sources such as radiators or air ducts, or in a place subject to direct sunlight, excessive dust, mechanical vibration or shock.
- Do not install the unit in an inclined position. It is designed to be operated in a horizontal position only.
- Do not place heavy objects on the unit.
- If the unit is brought directly from a cold to a warm location, moisture may condense inside it. When you first install the unit, or when you move it from a cold to a warm location, wait for about one hour before operating the unit.

Information

For customers in the USA

This equipment has been tested and found to comply with the limits for a Class B digital device, pursuant to Part 15 of the FCC Rules. These limits are designed to provide reasonable protection against harmful interference in a residential installation. This equipment generates, uses, and can radiate radio frequency energy and, if not installed and used in accordance with the instructions, may cause harmful interference to radio communications. However, there is no guarantee that interference will not occur in a particular installation. If this equipment does cause harmful interference to radio or television reception, which can be determined by turning the equipment off and on, the user is encouraged to try to correct the interference by one or more of the following measures:

- Reorient or relocate the receiving antenna.
- Increase the separation between the equipment and receiver.
- Connect the equipment into an outlet on a circuit different from that to which the receiver is connected.
- Consult the dealer or an experienced radio/TV technician for help.

You are cautioned that any changes or modifications not expressly approved in this manual could void your authority to operate this equipment.

Owner's record

The model number is located at the rear and front of the unit and the serial number on the top. Record the serial number in the space provided below. Refer to them whenever you call upon your Sony dealer regarding this product.

Model No. MDP-550

Serial No. _____

If you have any questions or problems concerning your unit, please contact your nearest Sony dealer.

Getting Started

- 5 Step 1: Unpacking
 - 5 Step 2: Inserting batteries into the remote commander
 - 6 Step 3: Connecting the player
-

Basic Operations

- 8 Playing a disc
- 10 Resuming LD playback (Auto Resume)
- 11 Quick-starting LD playback (Quick Start)
- 12 Searching for a particular point on the disc
- 13 Using the sound control functions
- 14 Understanding on-screen indications

Additional Operations

- 16 Specifying a chapter or track directly (Chapter/Track Search)
- 17 Searching by frame number or time (Frame/Time Search)
- 18 Viewing frame-by-frame action
- 19 Viewing at varying speeds (Multi Speed)
- 20 Playing in a specified order (Program Play)
- 22 Playing a section repeatedly (Repeat Play)
- 23 Playing karaoke

EN

Additional Information

- 25 Troubleshooting
- 26 Specifications
- 27 Optical discs

- 29 **Index to parts and controls**
- 31 **Index**

Welcome!

Thank you for purchasing the Sony Laser Disc (LD) player.

The MDP-550, an easy-to-operate laser disc player, allows you to:

- Play many types of optical discs, LDs, CDs and CDVs
- Play a double sided LD without turning it over
- Continue an LD from the exact point at which you stopped—Auto Resume
- Scan scenes at variable speeds—Shuttle ring
- Freeze frame or play at variable speeds with CAV LDs—Still/Step and Multi Speed Play
- Use your remote commander (Unicommander ®) to control Sony TVs
- Play karaoke (sing along with a disc) using a microphone and digital echo

Compatible color systems

This LD player plays video discs recorded in the NTSC color system.

Step 1

Unpacking

Check that you have the following items:

- Remote commander (Unicommander® RMT-M33A)

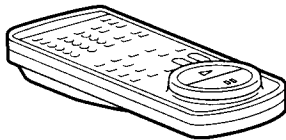

- Audio/Video cable

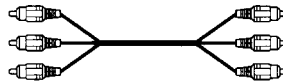

- Two size AA (R6) batteries

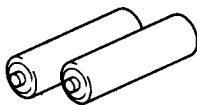

- AC power cord



Getting Started

Step 2

Inserting batteries into the remote commander

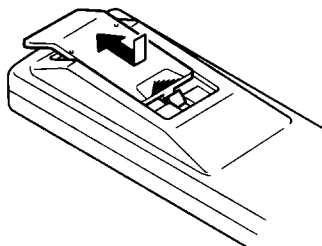

- 1 Turn the commander over, and remove the cover.

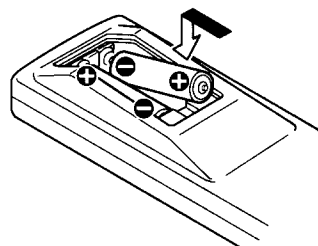

- 2 Check the polarities and position two size AA (R6) batteries correctly.

3 Close the cover.

Notes

- With normal use, the batteries should last for approximately six months.
- Use two size AA (R6) batteries.
- If you use the batteries incorrectly, they may leak or explode. See notes below for correct usage.
 - Insert the batteries with correct polarity as shown above.
 - Do not use a new battery together with an old one.
 - Do not use different types of batteries together.
 - Do not recharge the batteries.
 - If you are not going to use the remote commander for an extended period of time, remove the batteries to avoid possible damage from battery leakage.
 - If battery leakage should occur, wipe off the leakage from the battery compartment, then insert new batteries.
- Do not let direct sunlight or powerful artificial light such as spot light fall directly on the remote sensor on the front panel of the player. Such light interferes with the signals from the remote commander, causing the remote commander to fail to operate correctly.

Step 3

Connecting the player

Television hook-up

To play LDs or CDVs, hook up a television to the LD Player. Take out the supplied audio/video cable (yellow, red and white plugs). Use this to connect the player to the television. Once you have hooked-up the television, set the input selector on the TV to "Video." Before connecting or disconnecting any of the cables, turn off all equipment. If your TV has an S video input jack, using a YC-15V S Video Connecting Cable instead of the supplied video cable to connect the player will give you a better picture.

Notes

- Make sure all equipment is turned off before connecting or disconnecting any cables.
- Connection methods may differ; when in doubt about a connection, consult the TV or VCR manufacturer's manual.
- If the sound or picture is disturbed by noise, try moving the equipment farther apart.
- Firmly insert plugs into the jacks. A loose connection may cause noise.
- To prevent interference with TV broadcast reception, turn off all equipment connected but not currently in use.
- If your TV only has a monaural phono jack for audio input, use a VMC-910/915 Connecting Cable (not supplied).
- If you connect the CONTROL S IN jack to the CONTROL S output jack on your TV, etc. using an RK-G69 Connecting Cable (not supplied), you can control this player with the remote commander pointed at the TV, etc.
- If you plug one end of the cable into the CONTROL S IN jack on the player and leave the other end unplugged, the remote commander cannot control the player.

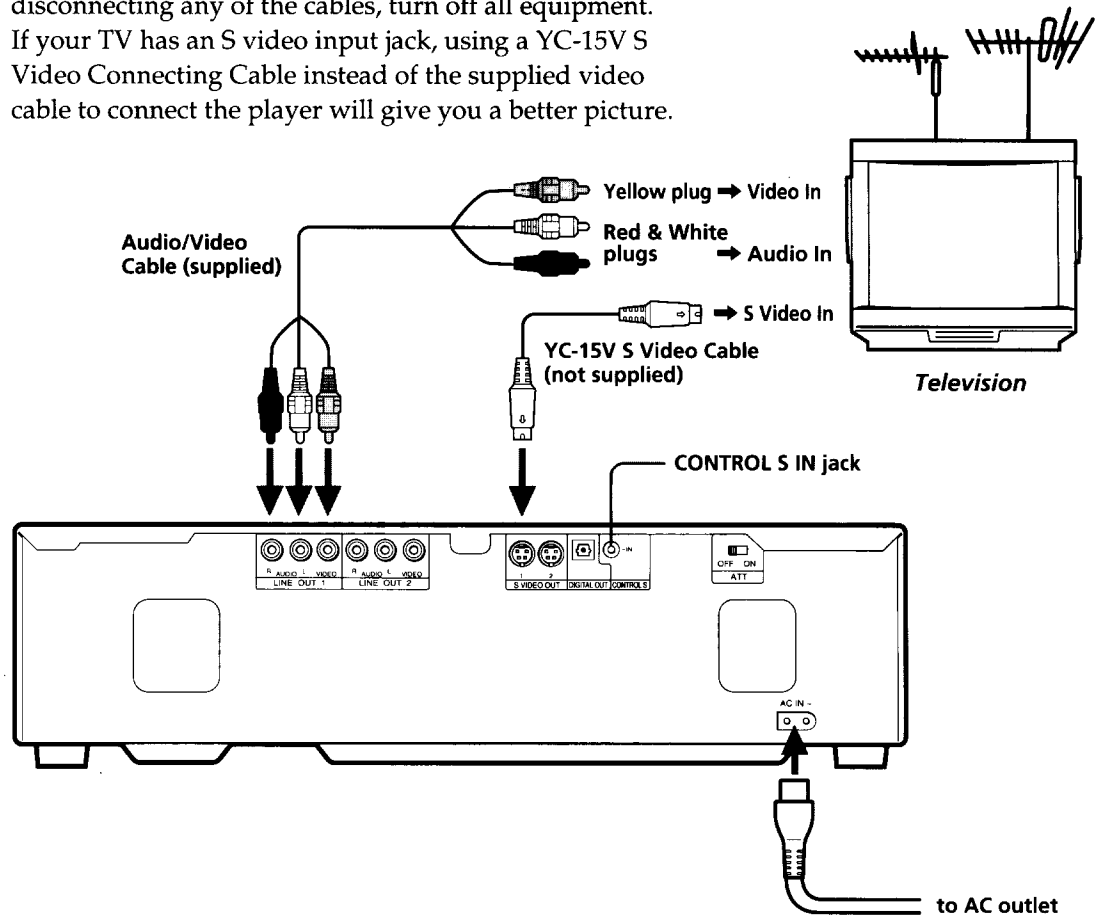

Television/VCR hook-up

Connect the LD player to the VCR's inputs when:

- the video inputs of the TV are already used for the VCR or a similar machine.
- the TV has only an antenna input.

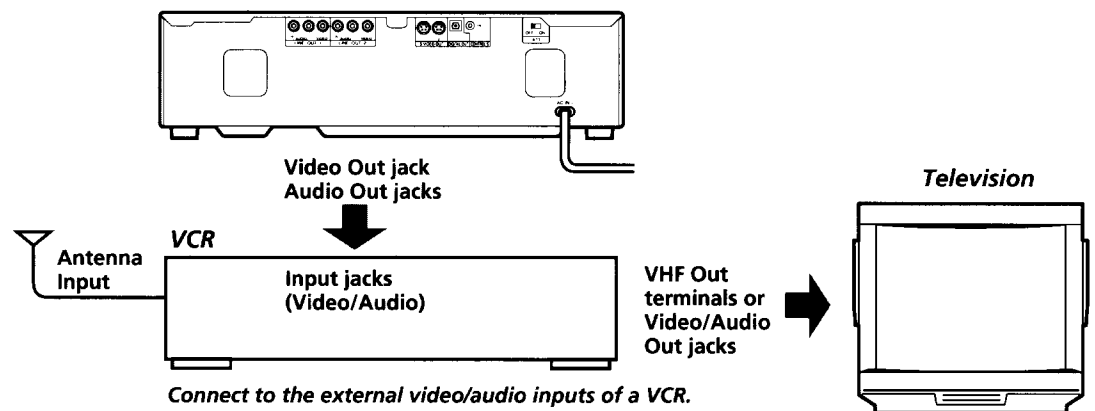

Audio equipment hook-up

To achieve full stereo sound from your LD Player, hook up a stereo system following the diagram below. Use an RK-C310 (or RK-C315) Audio Connecting Cable (not supplied) to connect the LD Player to your amplifier or receiver. Before connecting or disconnecting any cables, turn off all equipment.

Notes

- Make sure all equipment is turned off before making any of the above connections.
- Firmly insert plugs into the jacks. A loose connection may cause noise.
- When listening to a radio broadcast, turn off the LD Player to get better reception.

To achieve digital sound

Optical fiber digital audio output enables a high quality sound reproduction. If your amplifier has an optical input connector, or if you have a D/A converter unit with optical input, connect the player to the amplifier or D/A converter using an Optical Fiber Audio Cable POC-15 (not supplied).

- You can get digital audio output from CDs, CDVs, and most LDs. When you play an LD which does not have digital sound tracks, you cannot get any sound from the DIGITAL OUT (OPTICAL) connector.
- Sound from a microphone is not output from the DIGITAL OUT (OPTICAL) connector. When you play karaoke with a microphone, connect the player using an Audio Cable (red & white plugs).

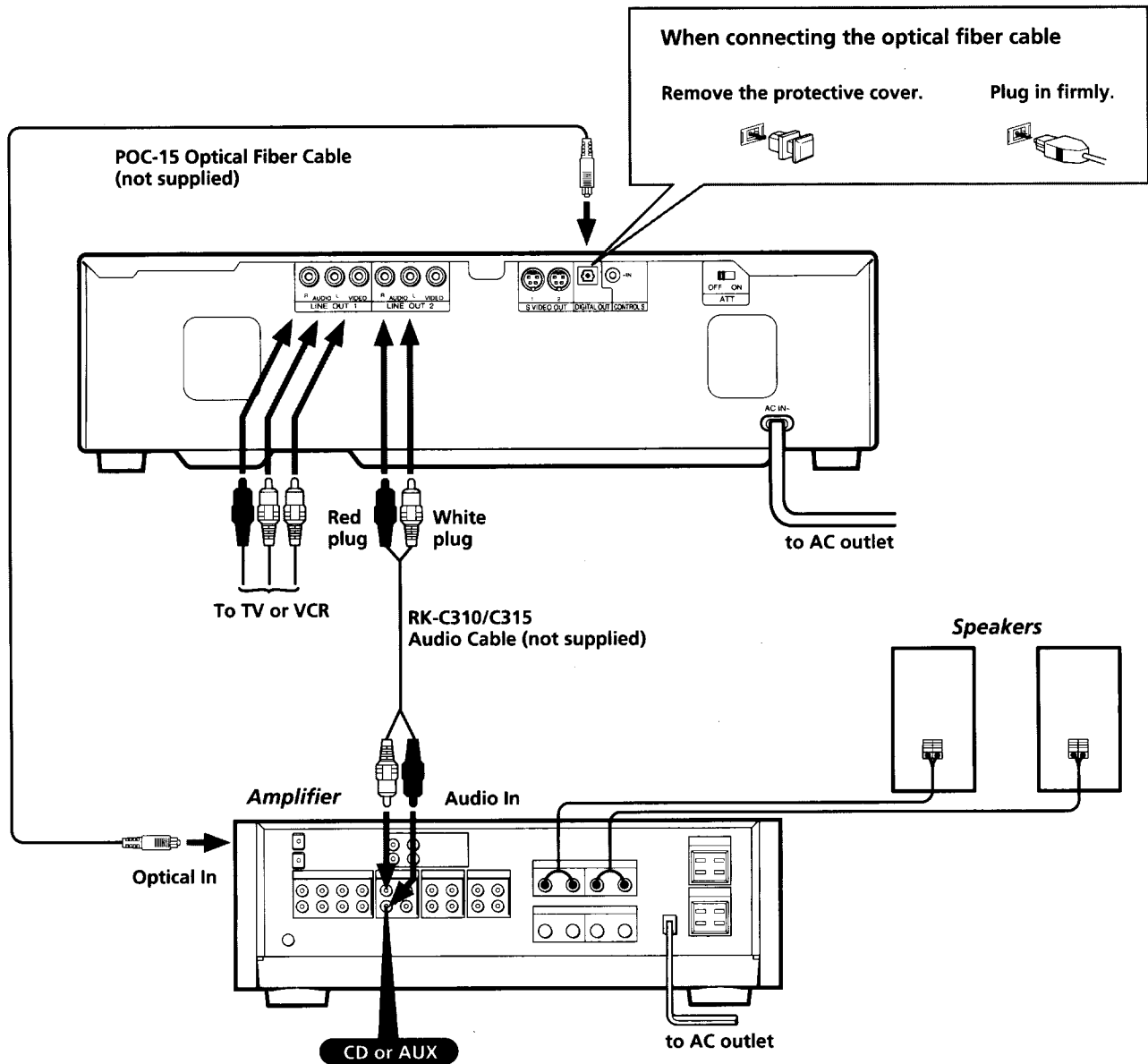

Basic Operations

Playing a disc

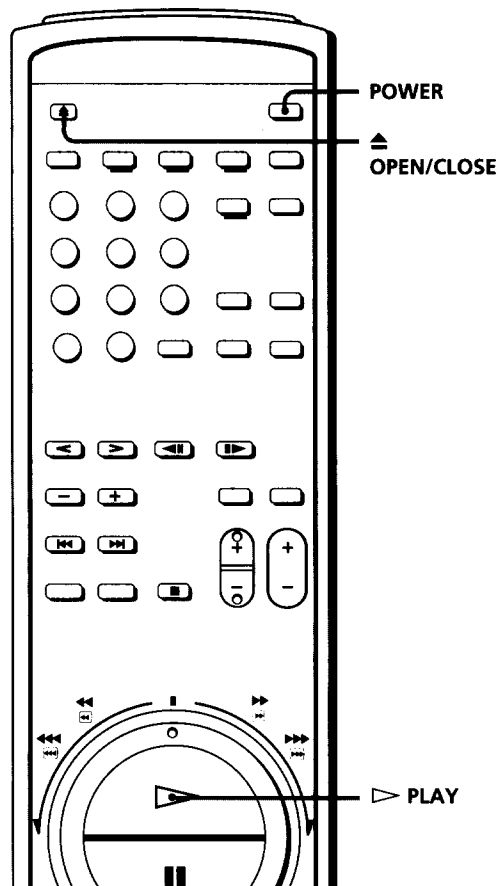

Tip

- You can also turn on the player by pressing \triangle OPEN/CLOSE on the player.

Notes

- If you place more than one disc on the disc tray, or if the disc is not seated properly, the disc may not start playing, and may damage the disc or player.
- Do not lift up or transport the player while a disc is loaded as doing so may damage your disc or player.
- Do not use a CD stabilizer when playing a CD as doing so may damage your disc or player.
- When you press \mathbb{I} PAUSE, the picture goes blank when playing a CLV LD or CDV, and the picture freezes when playing a CAV LD (see "Viewing frame-by-frame action" on page 18).

This section shows you how to play an LD, CD or CDV.

Before you start...

- Connect the player to your TV and set the input selector on the TV to "Video" (see "Connecting the player" on page 6).
- If you use a stereo system, turn on the amplifier and set its input selector to an external input such as "CD" or "AUX" to listen to the sound of the player.

Loading and playing a disc

- Press POWER to turn on the player.**
You can also directly turn on the player by pressing \triangleright PLAY on the player or remote commander.
- Press \triangle OPEN/CLOSE to open the disc tray.**
The front cover of the player automatically slides down and the disc tray comes out.
- Place a disc on the disc tray.**

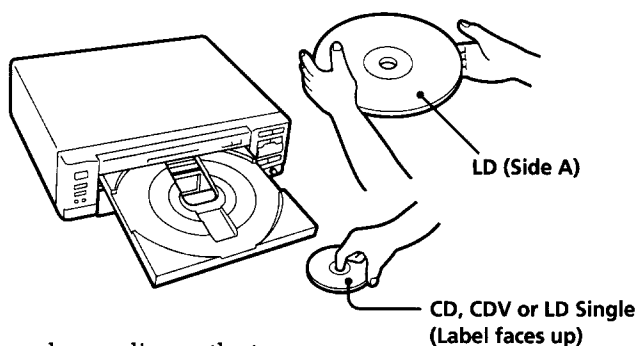

Place only one disc on the tray, carefully fitting it in the circle on the tray.

- Press \triangleright PLAY (or DISC SIDE A).**
The disc tray closes and the upper side of the disc starts playing. You can also start playing by pressing the disc tray to close it.
When playback of the upper side of an LD (side A) ends, the other side (side B) starts playing automatically.

To	Press
Stop play	\blacksquare STOP
Pause play	\mathbb{I} PAUSE
Resume play after pause	\mathbb{I} PAUSE or \triangleright PLAY
Scan forward or backward	\lll/\ggg SCAN on the player or rotate the SHUTTLE ring
Skip chapters or tracks	\lll/\ggg ACS/AMS
Remove the disc	\triangle OPEN/CLOSE

Tips

- When playing a double-sided LD, the player determines that the upper side of the disc is side "A" and the other side is "B," regardless of the label "A" or "B" printed on the disc.
- When playback of LD side B ends, the player stops.
- When playing a CD or CDV, the DISC SIDE B button does not function.
- If the sound is distorted or the picture flickers when listening through your TV speakers, set the ATT switch to ON to lower the output level.

Tips

- The AV calendar shows the chapters/tracks remaining on the disc. As chapters/tracks are played, the corresponding numbers on the calendar disappear.
- When there is no disc in the player, "NO DISC" appears on the front panel display.

Notes

- The AV calendar is available when you play LDs containing TOC (Table of Contents) data, CDs or CDVs. When you use the AV calendar with those LDs, press the QUICK START button to turn off the button indicator before you start playing (see "Quick-starting LD playback" on page 11 for details). When you play CDs or CDVs, the QUICK START indicator goes off automatically and the AV calendar always appears.
- If you turn off the front panel display, the blue screen which appears when you stop playing or do a search on an LD (or pause a CLV LD) turns gray.

To start playing from the beginning of either LD side

Press DISC SIDE A to play the upper side of the LD from the beginning. Press DISC SIDE B to play the other side of the LD from the beginning.

To play only one side of an LD

Press 1/SIDE/ALL twice. "ONE SIDE" appears briefly.

Press ▷ (Play) or DISC SIDE A/B.

The selected side of the LD is played once.

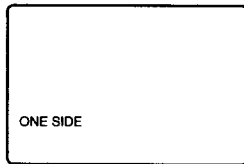

To pause playing just before starting

Press || PAUSE instead of pressing ▷ PLAY, after you place the disc on the tray.

The disc tray closes and the player waits at the start of the disc until you press ▷ PLAY or || PAUSE. If you want to start from side B of an LD, press || PAUSE, then DISC SIDE B.

To stop playing and turn off the player

Press POWER.

You can resume playback from the point at which you stopped by simply pressing ▷ PLAY (see "Resuming LD playback" on page 10).

To stop playing and remove the disc

Press ▲ OPEN/CLOSE.

Remove the disc and press ▲ again to close the empty tray.

Reading the front panel display

The illustration below is an example of what is displayed on the front panel of the player. For more information about the AV calendar, see the tips and note on the left hand of this page and "Quick-starting LD playback" on page 11.

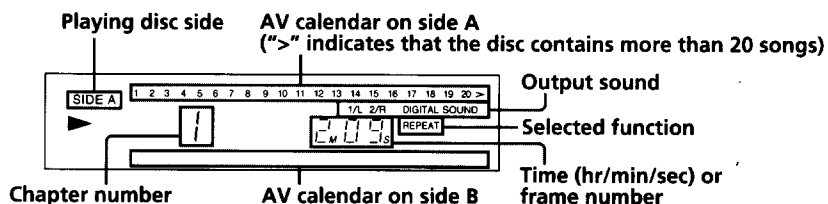

Turning off and on the front panel display

You can turn off the front panel display if you feel the display glaring while you view a movie in a dark room. Each time you press the FL DISPLAY button on the player, the display turns off/on.

Resuming LD playback (Auto Resume)

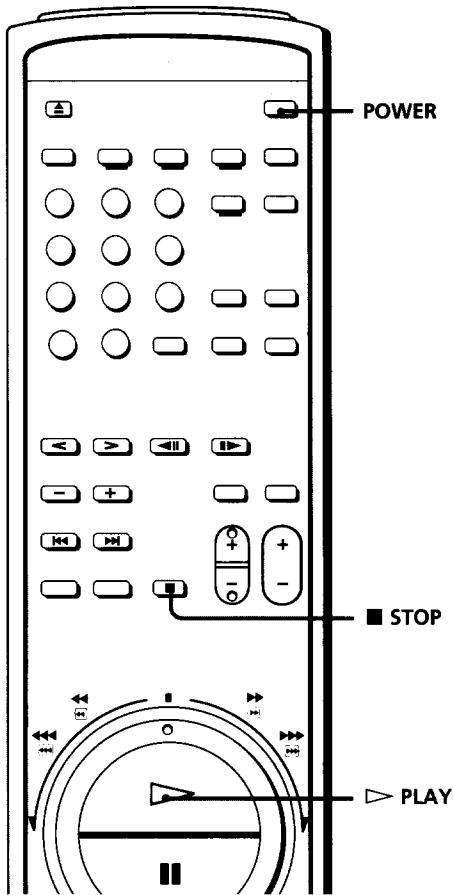

Tips

- Each time you stop playing, the point where you stopped is stored.
- The point at which you stopped playing is cleared when:
 - you completely open the disc tray, press DISC SIDE A/B or ◀◀/▶▶ ACS/AMS.
 - you do a Chapter Search or Frame/Time Search.
 - you press PROGRAM.
 - you unplug the player.

If you press ▲ OPEN/CLOSE to close the disc tray when it is open halfway, the point at which you stopped is retained.

Notes

- Playback may resume at a point slightly different from the point at which you stopped playback.
- The point at which you stopped is not stored if you stop playback during a Chapter Search or Frame/Time Search, or while in program mode.
- If you press ▷ PLAY when the power is off, the player turns on automatically. If a disc is loaded, playback resumes where you last stopped.

This function operates automatically only for LDs. Once you stop playing an LD by pressing ■ STOP or POWER, the player stores the point you stopped at so that you can continue viewing from the same point.

1 Press ■ STOP (or POWER) to stop playback.

The AUTO RESUME indicator on the player lights up and the point you stopped at is stored (if you press POWER, the indicator lights up briefly, then goes off with the power).

2 Press ▷ PLAY.

The player searches for the scene at which you stopped playing, then playback starts.

To pause playing just before starting

If the player is turned on, press || PAUSE instead of ▷ PLAY.

If the player is turned off, press POWER or ▷ PLAY to turn on the player, then press || PAUSE.

To view from the beginning of the LD

Press DISC SIDE A to start playing from the beginning of side A.

Press DISC SIDE B to start playing from the beginning of side B.

The point at which you stopped is cleared.

Quick-starting LD playback (Quick Start)

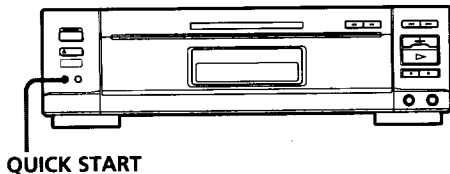

Notes

- Once the player has read TOC data of an LD after you turned off the Quick Start function, you cannot turn on the Quick Start function until you open the disc tray or turn off the player.
- When you play a CD or CDV, the Quick Start function is automatically turned off.

Tip

- TOC data contains some information on the disc including amount of chapters, total playing time, and information about each chapter.

The Quick Start function remarkably shortens the starting time of an LD by skipping the TOC data read procedure. When the QUICK START button indicator on the player is lit, the Quick Start function is active and you can start playing the LD very quickly.

Selecting Quick Start on/off

When you turn on the player, the QUICK START button indicator always lights up and the Quick Start function is turned on. If you turn off the Quick Start function, the player reads TOC data on the current side of the LD when the disc starts playing, allowing you to use several functions (see table below).

To turn off (or, then on) the Quick Start function

Press QUICK START on the player while the player is stopped. Each time you press QUICK START, the QUICK START button indicator is turned off/on.

Indicator	The player starts playing an LD
On	Without reading TOC data, to save time
Off	Reading TOC data, so that you can use the functions shown below: <ul style="list-style-type: none">• AV calendar• Remaining time of the current chapter• Total remaining time on the current disc side• Total elapsed time for CAV discs• Total playing time of chapters you programmed

Searching for a particular point on the disc

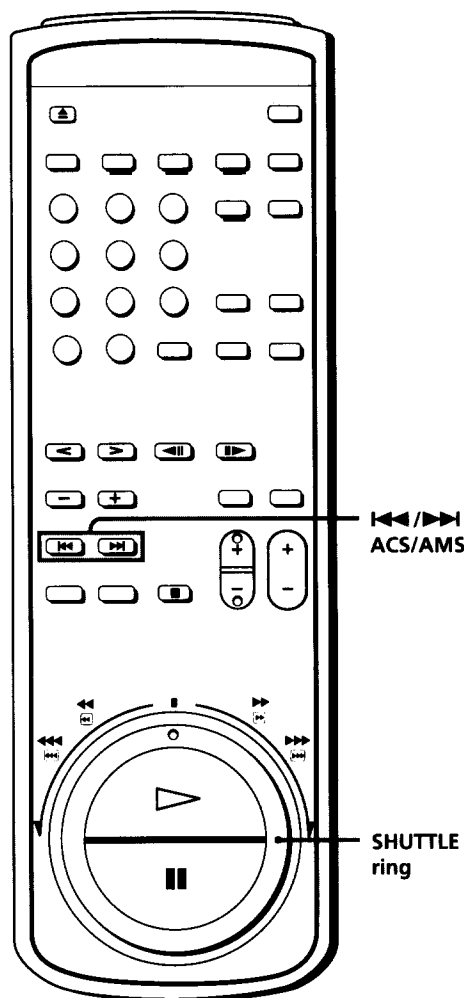

You can locate a particular point on a disc by scanning scenes at variable speed or skipping chapters/tracks.

Scanning a disc quickly (Variable Speed Scan)

Rotate the SHUTTLE ring on the remote commander while playing a disc.

The scanning speed changes from about $\times 10$ to $\times 30$ times the normal speed corresponding to the degree you rotate the the SHUTTLE ring. To resume normal playback, release the SHUTTLE ring.

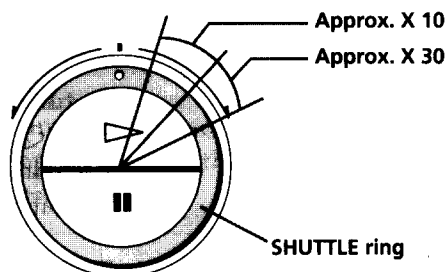

You can also scan a disc by holding down the \lll or \ggg SCAN button on the player while playing the disc. The scanning speed is constant at 10 times the normal speed.

To	Hold down
Scan forward	\ggg SCAN
Scan backward	\lll SCAN

To resume normal playback, release \lll/\ggg SCAN.

Skipping chapters or tracks (Skip Search)

Press or hold down \lll/\ggg ACS/AMS on the player or remote commander.

To go to the beginning of	Press
Next chapter/track	\ggg ACS/AMS once
Current chapter/track	\lll ACS/AMS once
Previous chapter/track	\lll ACS/AMS twice before the picture or sound resumes

Hold down \ggg or \lll to skip chapters/tracks continuously.

Notes

- A certain amount of visual noise and instability is inevitable when scanning an LD.
- When scanning a CLV LD or CDV, speed varies between the beginning and end of a side.

Tips

- ACS/AMS stands for Automatic Chapter Sensor/Automatic Music Sensor.
- In addition to normal play mode, you can do Variable Speed Scan and Skip Search while in Freeze Frame, Repeat or Pause mode. After the scan or search, playback continues in the same mode.
- You can also do a Skip Search while using Multi Speed.

Using the sound control functions

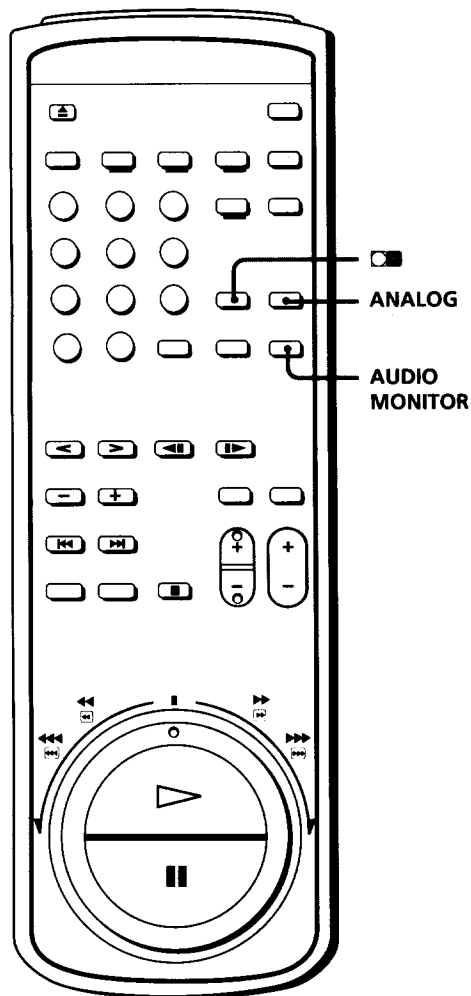

Playing a stereo disc or Second Audio Program (SAP) disc

When playing SAP discs such as bilingual discs, you can alternate the sound output using the AUDIO MONITOR button.

To alternate the sound output

Press AUDIO MONITOR while playing the disc.

Each time you press AUDIO MONITOR, the on-screen indication changes as follows:

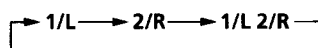

The indication appears on the screen briefly, then disappears.

Indication	From stereo disc	From SAP disc
1/L	Left channel	Sound track 1 (Left channel)
2/R	Right channel	Sound track 2 (Right channel)
1/L 2/R	Stereo (Both channels)	Sound track 1 (Left channel) Sound track 2 (Right channel)

When you select 1/L (or 2/R), the sound of the left (or right) channel is output from both speakers.

Listening to analog sound on an LD

If your LD contains digital soundtracks, the player automatically outputs digital sound. To listen to sound recorded on analog soundtracks, use the ANALOG button.

Press ANALOG while playing the disc.



"♪ ANALOG" appears on the screen briefly and analog sound is output.

To return to digital sound

Press ANALOG again.

"♪ DIGITAL" appears on the screen.

Playing discs with a (CX) logo

LDs bearing the  logo are recorded with the CX noise reduction system, which gives lower noise level and higher dynamic range on analog sound. The player detects most  discs and activates the CX noise reduction system automatically when outputting analog sound. If your  LD does not contain a code to activate the CX noise reduction system, you can activate the CX noise reduction system manually while playing analog sound.

To activate the CX noise reduction system manually

Press the  button. "CX ON" appears, and the CX noise reduction system is activated.

Notes

- The output level may differ between digital and analog sound.
- When using the DIGITAL OUT (OPTICAL) connector, you cannot alternate sound output (always 1/L 2/R).

Understanding on-screen indications

You can view the operating status of the player or disc information on the TV screen.

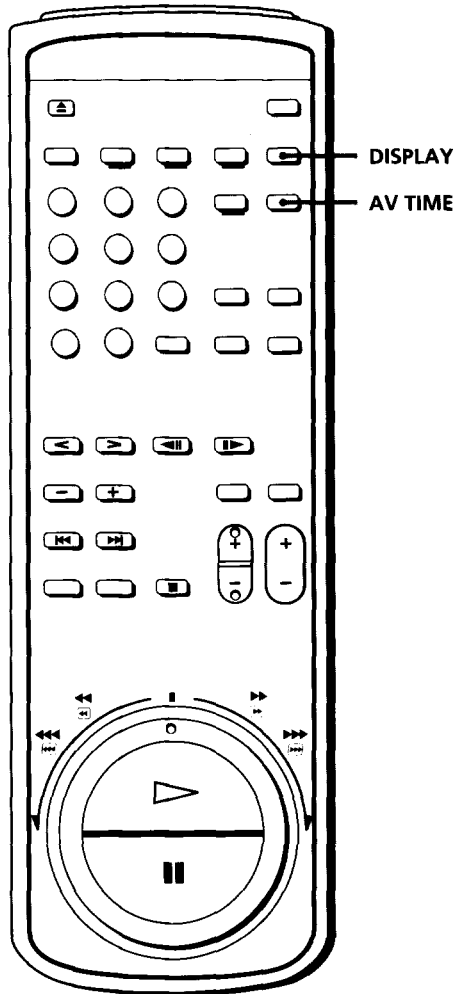

Displaying on-screen indications

Press DISPLAY.

The operating status of the player is displayed on the screen.

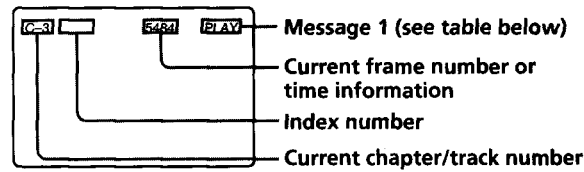

Press DISPLAY again.

Operating status and disc information are displayed on the screen.

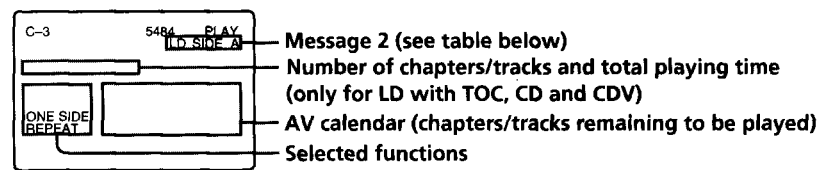

Press DISPLAY once again to turn off the indications.

Notes

- The AV calendar (display of remaining chapter numbers) for LDs is only available when:
 - the LD contains TOC data.
 - you have turned off the QUICK START button indicator on the player.
- When playing an LD which does not contain chapters, the chapter number does not appear.
- When playing a CLV LD which does not contain time data to the second, a two-digit number such as "22:", meaning 22 minutes, appears.
- Messages concerning sound control functions such as "1/L, 2/R" or "DIGITAL, ANALOG" appear only briefly when you press the AUDIO MONITOR or ANALOG button.

Message 1

Display	Current status of the player
OPEN	Disc tray open
CLOSE	Disc tray closed
PLAY	Playing a disc
STOP	Playback stopped
PAUSE	Playback temporarily stopped
◀◀ / ▶▶	Speed scanning (slow)
◀◀◀ / ▶▶▶	Speed scanning (fast)
SEARCH	Searching

Message 2

Display	Currently playing
LD SIDE A	Side A of LD
LD SIDE B	Side B of LD
CD	CD
CDV	CDV
1/L	First soundtrack/left channel
2/R	Second soundtrack/right channel
♪ DIGITAL	Digital sound
♪ ANALOG	Analog sound

Checking the elapsed or remaining time of the disc

You can check the elapsed or remaining time on the TV screen.

Press DISPLAY, then press AV TIME repeatedly.

Each time you press AV TIME, the on-screen display changes as follows. To use AV TIME while playing an LD containing TOC data, press QUICK START on the player to turn off the quick start function (see "Quick-starting LD playback" on page 11).

Notes

- When playing an LD which does not contain TOC data, or playing with the QUICK START button indicator on the player lit, you can only view the total elapsed time (for CLV disc) or current frame number (for CAV disc).
- The display does not show remaining time for chapters or tracks numbered 51 or greater.
- When playing a CDV, these figures refer only to the current section (audio or video) being played.

LDs with TOC

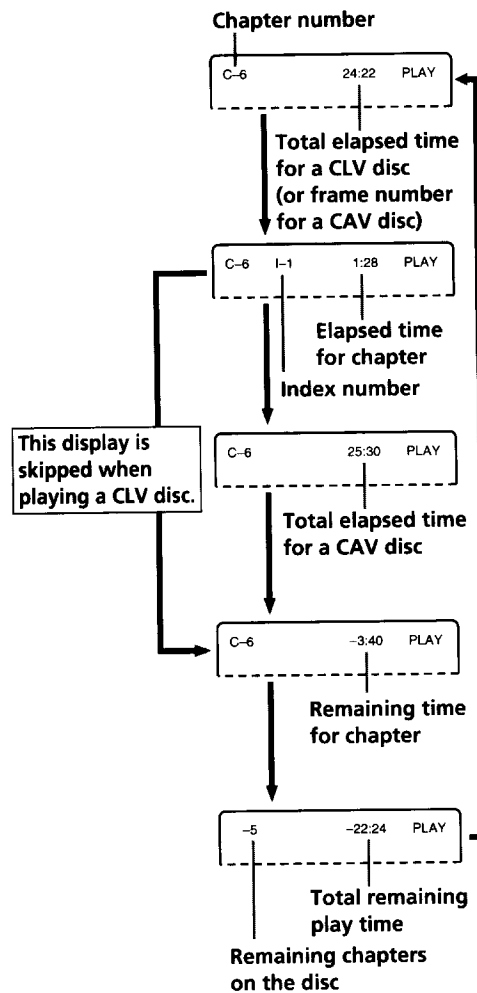

CDs/CDVs

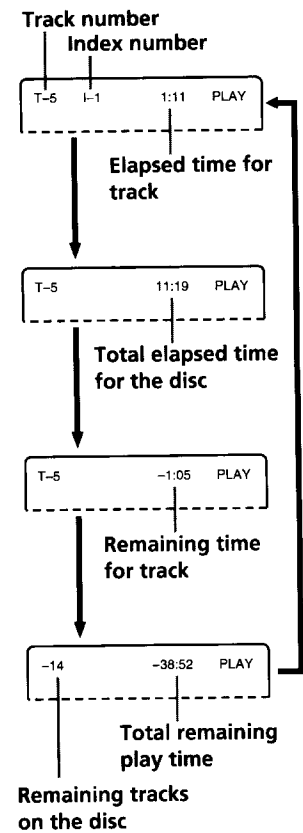

Additional Operations

Specifying a chapter or track directly (Chapter/Track Search)

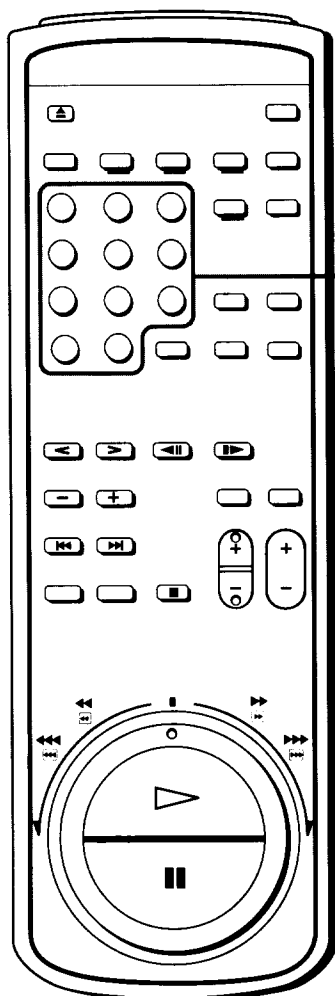

Number buttons

Tip

- In addition to normal play mode, you can do Chapter/Track Search while in Multi Speed, Freeze Frame, Repeat or Pause mode. When the specified chapter or track is located after the search, playback continues in the same mode.

Note

- Chapter Search does not function correctly if the LD does not contain chapter numbers, or if the chapter number entered does not exist.

LDs are divided into sections called "chapters." CDs and CDVs are divided into sections called "tracks." Simply enter the desired chapter/track number to go to a chapter or track and start playing it immediately.

Locating a particular chapter/track

Press one of the number buttons to enter the chapter/track number. The player goes to the chapter/track you entered, then playback starts.

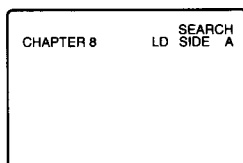

To play a chapter on the opposite side of the LD, press DISC SIDE B (or A), then enter the chapter number.

To enter a number greater than 10, press $\oplus 10$, then one of the $\odot - 9$ buttons. If you press $\oplus 10$ by mistake, press CLEAR, then enter the correct number.

To	Press
Enter 14	$\oplus 10$, then $\odot 4$
Enter 25	$\oplus 10$, $\oplus 10$, then $\odot 5$
Enter 30	$\oplus 10$, $\oplus 10$, $\oplus 10$, then $\odot 0$

To check the current chapter/track number on the screen

Press DISPLAY to display the chapter/track number. The number appears in the upper left-hand corner of the screen. If the LD does not contain chapter numbers, no number is displayed.

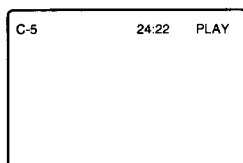

To play only one chapter/track

Press 1/SIDE/ALL once. "SINGLE" appears briefly. Enter the chapter/track number using the number buttons. The chapter or track is played once.

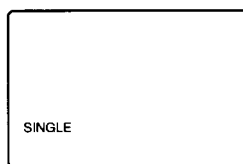

Searching by frame number or time (Frame/Time Search)

Video scenes are counted as a series of still pictures or "frames." When playing a CAV (standard-play) LD, the player keeps track of the number of frames. So, you can locate a scene on the CAV disc by specifying the frame number. When playing a CLV (extended-play) LD, the player keeps track of the elapsed playing time. So, you can locate a particular point on the CLV LD by specifying the total elapsed time.

Entering the frame number or elapsed time

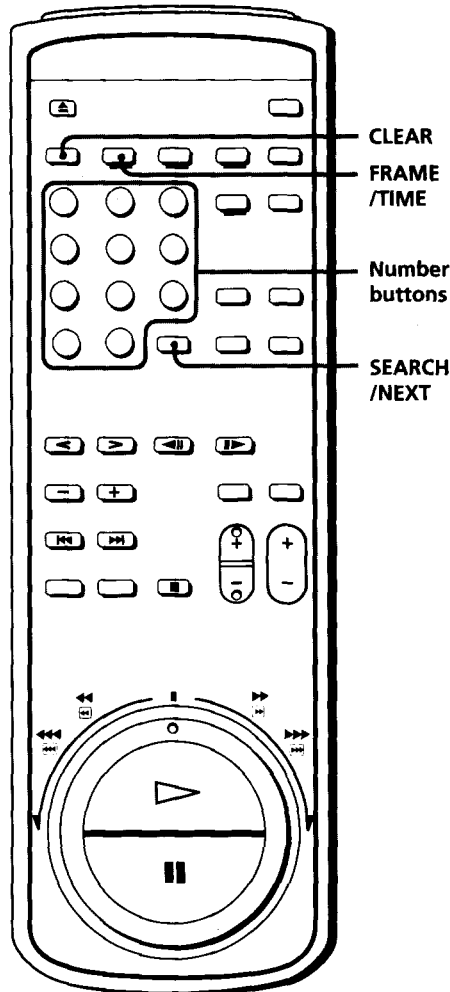

1 Press FRAME/TIME.

When playing	Indication
CAV LD	FRAME 00000
CLV LD	TIME 0:00:00

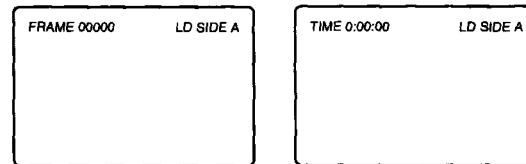

2 Enter the multi-digit number corresponding to the frame or time you want to locate.

To locate frame number 12340 on a CAV LD, press the number buttons in the order, ①, ②, ③, ④ and ①.

To locate the 12 minutes, 5 second point on a CLV LD, press the number buttons in the order, ①, ②, ① and ⑤.

If you enter the wrong number, press FRAME/TIME to clear the number, then enter the correct number.

3 Press SEARCH/NEXT.

The player searches for the frame or time you entered, then playback starts.

To check the frame number or time on the screen

Press DISPLAY.

The current frame number or time is displayed on the screen.

To cancel Frame/Time Search

Press CLEAR before pressing SEARCH/NEXT.

Tip

- In addition to normal play mode, you can do Frame/Time Search while in Multi Speed, Freeze Frame, Repeat or Pause mode. When the specified chapter or track is located after the search, playback continues in the same mode.

Note

- If you enter a frame/time number which does not exist on the disc, the last scene on the current side of the LD is played.

Viewing frame-by-frame action

You can use this function only for CAV LDs. During any scene, you can freeze play into a still picture, and then advance or reverse the action frame-by-frame.

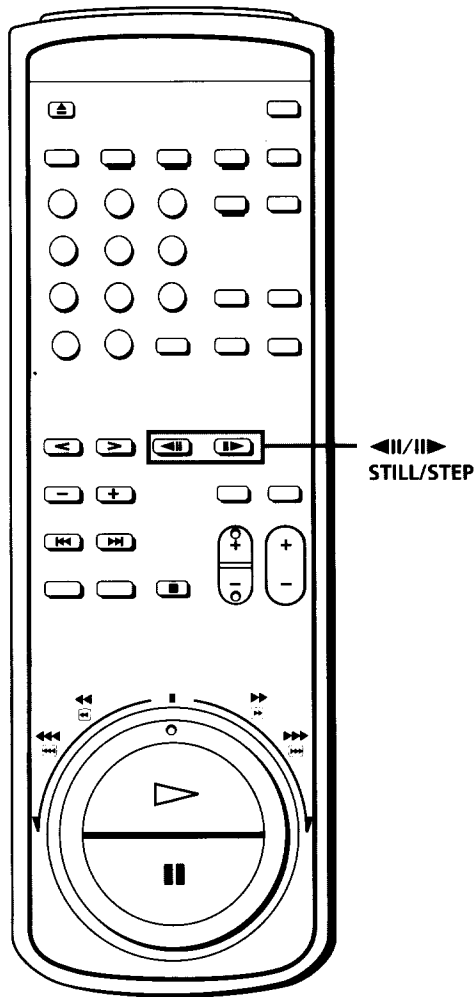

Freezing the action (Freeze Frame)

Press **||** PAUSE or one of the **◀||/||▶** STILL/STEP buttons while playing a CAV LD.

The sound mutes and the picture freezes.

To resume normal playback

Press **▷** PLAY.

Playing frame-by-frame (Step Play)

1 Press one of the **◀||/||▶** STILL/STEP buttons while playing a CAV LD.

The sound mutes and the picture freezes.

2 Press **◀||** or **||▶** repeatedly to advance or reverse the action frame-by-frame.

Hold down **◀||** or **||▶** to view continuous frame-by-frame action.

To resume normal playback

Press **▷** PLAY.

Viewing at varying speeds (Multi Speed)

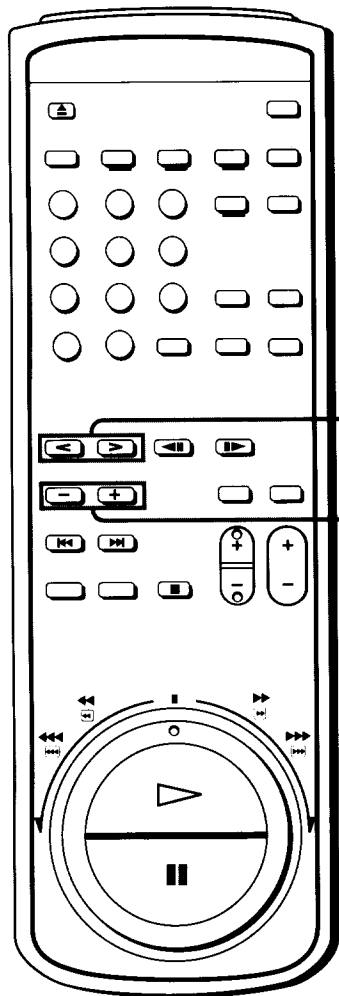

You can use this function only for CAV LDs. You can find a scene by playing a disc forward or in reverse at varying speeds.

Varying the direction and speed

- 1 Press MULTI SPEED < or > while playing a CAV LD to select the direction.**

Reverse: <

Forward: >

The playing speed and direction appear on the screen.

- 2 Press SPEED SET + or - to select the speed.**

To reduce speed: -

To increase speed: +

To resume normal playback

Press ▷ PLAY.

To check the direction and speed of playback

Press DISPLAY.

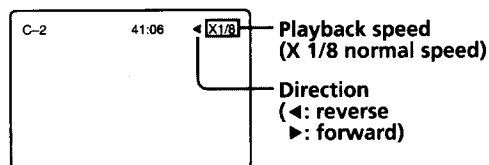

Notes

- The sound mutes except when playing at normal (x1) speed.
- If an automatic picture stop code (found on educational discs) is encountered during x1 or less variable speed play, the unit automatically stops at that frame. To resume playback, press ▷ PLAY, MULTI SPEED (< or >), or rotate the SHUTTLE ring.

Playing in a specified order (Program Play)

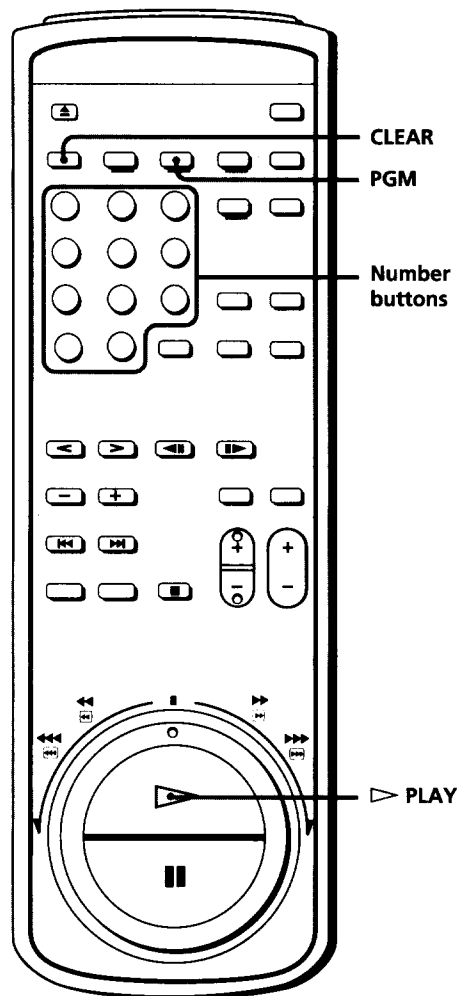

You can specify up to 25 chapters or tracks on a disc to be played in any order you like, regardless of disc side, even while the disc is being played. The chapters/tracks are played continuously in the order you specify.

Specifying chapters/tracks

1 Press PGM.

"PROGRAM" appears on the screen.
"PGM" flashes in the front panel display.

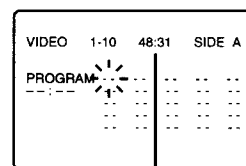

Total playing time of the disc (see note on the left)

2 Press the number buttons to specify chapters on the current disc side, or tracks on a CD or CDV, in the order you want them to play.

If you enter a wrong number, press CLEAR. With each press, the last chapter/track you entered is deleted.

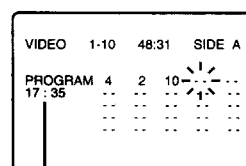

Total playing time of the program (see next page)

3 To enter chapters from the other disc side, press DISC SIDE B (or A), then press the number buttons to specify the chapters in the order you want them to play.

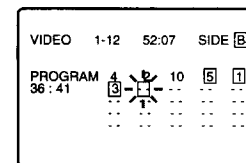

4 Repeat steps 2 (and 3) until you finish specifying chapters/tracks.

5 Press ▷ PLAY.

On-screen indications disappear and the program you made starts playing.
"PGM" on the front panel display stops flashing and lights up.

To change an entry (while "PGM" is flashing in the front panel)

Press SEARCH/NEXT or BACK repeatedly until the number you want to change flashes on the screen, then enter the correct number. If "PGM" is not flashing in the front panel display, press PGM to make the sign "PGM" flash, then use SEARCH/NEXT or BACK.

To clear all the entries together

Press CLEAR while "PGM" is flashing in the front panel display. If "PGM" is not flashing in the front panel display, press PGM to make the sign "PGM" flash, then press CLEAR.

To make a new program

Clear all the entries, then press PGM and specify chapters/tracks from the beginning.

Note

- Total playing time of the disc appears when the player has read TOC data of the disc. To make the player read TOC data of an LD, see "Checking the total playing time of the program" on page 21.

To enter a number greater than 10

Press $\oplus 10$, then one of the number buttons. If you press $\oplus 10$ by mistake, press $\oplus 10$ repeatedly until "--" flashes, then enter the correct number.

To	Press
Enter 15	$\oplus 10$, then 5
Enter 30	$\oplus 10$, $\oplus 10$, $\oplus 10$, then 0

Note

- The total playing time is not available with LDs not containing TOC data, even if you turn off the Quick Start function.

Checking the total playing time of the program

When you make a program on a CD or CDV, the total playing time of the program is always displayed on the screen and front panel display. If you want to check the total playing time while specifying chapters on an LD, you must make the player read TOC data of the LD following the procedures below before you start programming.

- 1 Press QUICK START on the player to turn off the indicator while the player is stopped.
- 2 Press \triangleright PLAY.
The player starts playing the disc and reads TOC data from side A. The AV calendar on side A appears on the front panel display. If you also want to select chapters on side B, press DISC SIDE B. The player starts playing side B and reads TOC data from side B. The AV calendar on side B appears on the front panel display.

Now you can make a program while viewing its total playing time.

If you enter II PAUSEs in the program

You can enter II PAUSEs among chapter/tracks you specify, to make the player automatically pause during playback of the program. If you enter a II PAUSE, the total playing time is re-counted from --:-- (zero).

To check the contents of the program

Press DISPLAY twice while playing the program.

The numbers of programmed chapters/tracks appear on the screen. The flashing number indicates the chapter/track currently being played.

To skip chapters/tracks while playing the program

Press \lll / \ggg ACS/AMS.

Each time you press \lll / \ggg ACS/AMS, the player skips one chapter/track within the program.

To play the program repeatedly

Press REPEAT.

"REPEAT" appears on the screen briefly and the player plays the program repeatedly.

Canceling program play

Press CLEAR.

The player resumes normal playback from the current chapter/track.

Tips

- You can advance to forward chapters/tracks in the program by rotating the SHUTTLE ring clockwise. However, you can not go back to previous chapters/tracks by rotating the SHUTTLE ring counterclockwise.
- The program you made is not cleared even after canceling program play. Press PGM to enter the program mode, then press \triangleright PLAY to play the same program again.
- The program is cleared when:
 - you press clear while "PGM" is flashing in the front panel display.
 - you press \blacktriangle OPEN/CLOSE.
 - you turn off the player.

Playing a section repeatedly (Repeat Play)

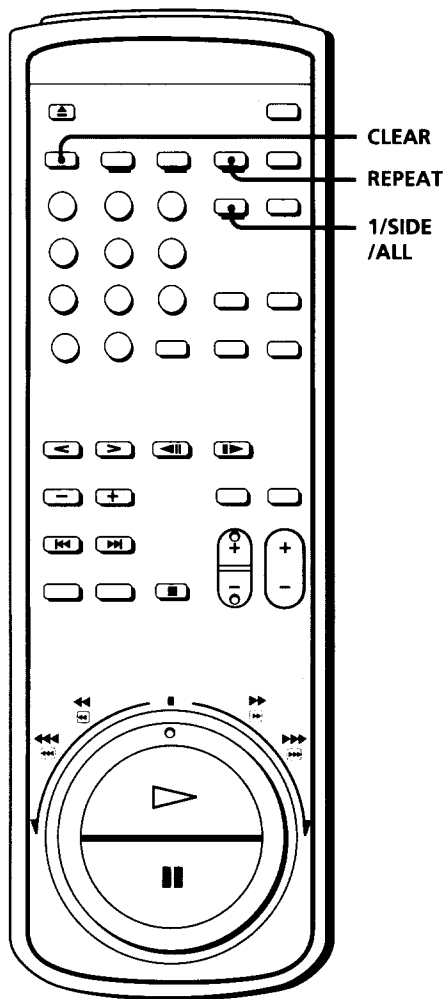

Repeat play allows you to play the disc over and over. You can replay both sides, a single side or one chapter of an LD, and a whole disc or a single track on a CD, or a portion you specified on the disc.

Repeating the whole disc (All Disc Repeat)

Press REPEAT.

"REPEAT" appears on the screen briefly. "REPEAT" lights up on the front panel display. When playing an LD, the player plays through both sides of the LD repeatedly. When playing a CD or CDV, the player plays all the tracks on the disc repeatedly.

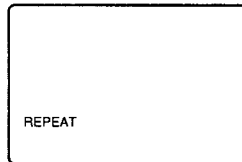

Repeating the selected side of the LD (One Side Repeat)

Press 1/SIDE/ALL twice, then press REPEAT.

"ONE SIDE" and "REPEAT" appear on the screen briefly. "REPEAT 1 SIDE" lights up on the front panel display. The player plays the selected disc side repeatedly.

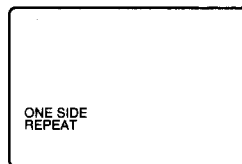

Repeating the selected chapter/track (Single Repeat)

Press 1/SIDE/ALL once, then press REPEAT.

"SINGLE" and "REPEAT" appear on the screen briefly. "REPEAT 1" lights up on the front panel display. The player plays the selected chapter/track repeatedly.

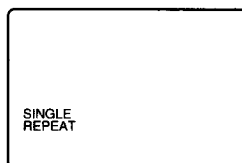

To check the repeat status

Press DISPLAY twice.

Canceling Repeat Play

Press CLEAR.

Playing karaoke

This section gives you short instructions for playing "karaoke" (singing along with a disc).

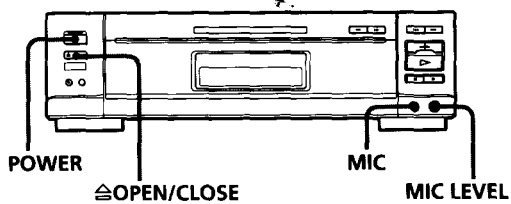

Starting karaoke

- 1** Set the MIC LEVEL control on the player to MIN, then plug a microphone into the MIC jack.

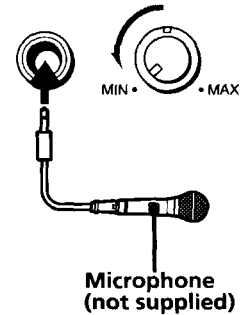

- 2** Press POWER to turn on the player.

- 3** Turn on the TV and stereo system.

TV:

Set to "Video."

Stereo system:

Turn on the amplifier or receiver and select CD or AUX for audio output.

- 4** Press \triangle OPEN/CLOSE.

The disc tray comes out.

- 5** Place a disc on the disc tray.

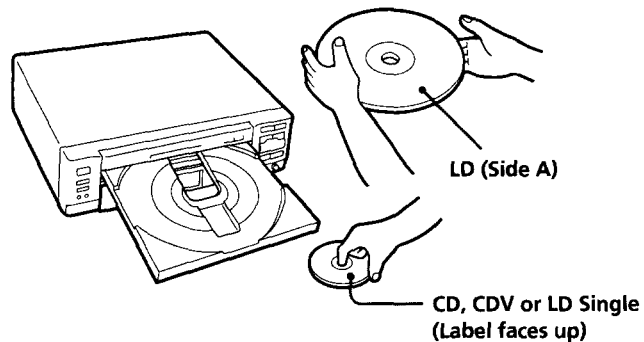

Place only one disc on the tray, carefully fitting it in the circle on the tray.

Notes

- If you insert more than one disc, or if the disc is not seated properly, the disc may not start playing, and may damage the disc or player.
- When playing a double-sided LD, the player determines that the upper side of the disc is side "A" and the other side is "B," regardless of the label "A" or "B" printed on the disc.

Playing karaoke (continued)

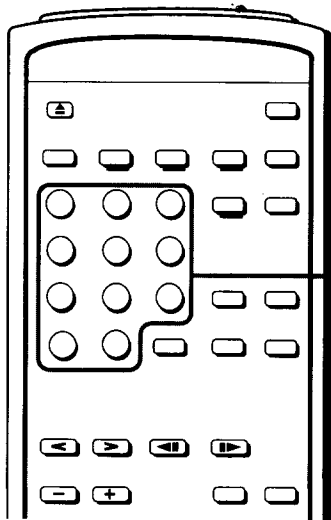

Number buttons

- 6 Press one of the number buttons on the remote commander to choose the song you want to play.**
The disc tray automatically closes and the song starts playing. To choose a song on side B of the LD, press DISC SIDE B, then press the number button.

- 7 Set the ON/OFF switch on the microphone to ON and turn the MIC LEVEL control to adjust the microphone volume.**



- 8 Turn the ECHO control to adjust the strength of echo.**

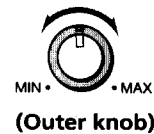

Now you can enjoy playing karaoke.

Tips

- If howling occurs
 - Move the microphone away from the speakers.
 - Lower the microphone volume or echo level.
 - Lower the volume.
- If the sound is distorted or the picture flickers when listening through your TV speakers, set the ATT switch at the rear of the player to ON to lower the output level.
- Program Play gives you non-stop karaoke entertainment (see “Playing in a specified order” on page 20).

Note

- Use the ANALOG or AUDIO MONITOR button to select the sound. When you play MULTI AUDIO karaoke LDs, the player automatically outputs the backup sound without vocals. Use the ANALOG button to listen to the original vocals recorded in analog tracks. If you use other types of discs such as multiplex karaoke CDs, use the AUDIO MONITOR button to select whether to output only the backup sound or sound with the original vocals (see “Using the sound control functions” on page 13).

To enter a number greater than 10

To	Press
Enter 14	$\oplus 10$, then 4
Enter 25	$\oplus 10$, $\oplus 10$, then 5
Enter 30	$\oplus 10$, $\oplus 10$, $\oplus 10$, then 0

Additional Information

Troubleshooting

	Symptom	Remedy
Power	No Power	<ul style="list-style-type: none"> • Connect the AC power cord securely.
Playback	Playback does not start	<ul style="list-style-type: none"> • Insert the disc correctly. When playing a CD, CDV or LD single, place it with the label facing up. • Select the disc side on which signals are recorded. • If there may be moisture condensation within the player, wait for about one hour before operating the player. • Clean the disc.
	LD does not start playing from the beginning of the disc side	<ul style="list-style-type: none"> • Press DISC SIDE A (or B) to start playing from the beginning of the disc side.
Picture	No picture, but "▶" lights up on the front panel display	<ul style="list-style-type: none"> • Connect the TV correctly. • Switch on the TV and set the input selector on the TV to "Video."
	Poor picture	<ul style="list-style-type: none"> • Connect the TV correctly. • Clean the disc.
	Visual noise while scanning a disc	<ul style="list-style-type: none"> • A certain amount of visual noise and instability is inevitable while scanning a disc.
	Freeze Frame does not operate	<ul style="list-style-type: none"> • Use a CAV disc. Freeze Frame does not operate on CLV LDs, CDVs or VSDs.
Sound	No sound	<ul style="list-style-type: none"> • Connect the TV or amplifier correctly. • Turn up the volume on the TV or amplifier. • Switch on the amplifier and set the input selector to "CD" or "AUX." • Playback at normal speed. No sound is output while in Pause, Still/Step mode, or using Multi Speed other than at normal (×1) speed.
Karaoke	No sound from microphone	<ul style="list-style-type: none"> • Switch the microphone on. • Turn up the MIC LEVEL control on the player • Use an Audio Cable (red & white plugs) to connect the player. Microphone sound is not output from the DIGITAL OUT (OPTICAL) connector.
	Distorted sound	<ul style="list-style-type: none"> • Set the ATT switch at the rear of the player to ON.
	Howling occurs	<ul style="list-style-type: none"> • Move the microphone away from the speakers. • Lower the volume. • Lower the microphone volume or echo level.
Others	Remote Commander does not operate	<ul style="list-style-type: none"> • Turn on the player. • Point the remote commander at the remote sensor on the player. • Remove any obstacles between the remote commander and the sensor. • Insert the batteries correctly. • Replace both the batteries with new ones if they are weak.

Specifications

System

- Type**
CD/CDV/LD player
- Signal readout**
Optical (Laser beam reflection)
- Signal format system**
EIA standard, NTSC color system
- Playing time**
See "Optical discs" on page 27.

Digital audio specifications

- Signal-to-noise ratio**
More than 115 dB (EIAJ)*
- Dynamic range**
More than 99 dB (EIAJ)
- Wow and flutter**
Below measurement limit
(+0.001 % W.PEAK)(EIAJ)

Video specifications

- Horizontal video resolution**
425 lines
- Signal-to-noise ratio**
More than 50 dB

* Measured according to EIAJ (Electric Industries Association of Japan) standards.

Input and Output

LINE OUT 1,2

VIDEO output, Phono jack (1)
Output signal: 1 Vp-p, 75 ohms, unbalanced
AUDIO output, Phono jacks (2)
Stereo L, R
Analog: 200 mVrms
(1 kHz, 40 % modulation)
Digital: 200 mVrms
(1 kHz, -20 dB)

S VIDEO OUT 1,2

Luminance: 1 Vp-p, 75 ohms, unbalanced, sync negative
Chrominance: 0.286 Vp-p, 75 ohms, unbalanced

DIGITAL OUT (OPTICAL)

-18 dBm, wavelength 660 nm

Mic jack

Standard jack
1 mV
(Impedance below 1 kilohm)

General

- Power requirements**
120 V AC, 60 Hz
- Power consumption**
45 W
- Operating temperature**
5 °C to 35 °C (41 °F to 95 °F)
- Ambient humidity**
5 % to 90 %
- Dimensions**
Approx. 430 × 116 × 433 mm
(17 × 4 5/8 × 17 inches)
(w/h/d)
including projecting parts and controls
- Mass**
Approx. 7.5 kg (16 lb 8oz)



Supplied accessories

Remote Commander RMT-M33A (1)
size AA (R6) batteries (2)
Audio/Video Cable
(phono plug 3 ↔ phono plug 3) (1)
AC power cord (1)

Design and specifications are subject to change without notice.

Optical discs

The MDP-550 can play all three types of optical discs currently available for home entertainment, laser discs (LD, recorded in NTSC standard), compact discs (CD) and compact disc videos (CDV).*

Disc class	Disc logo	Disc type	Size	Sides	Play time	
Laser Discs For movies, operas, and concerts	 	LD Single	8 in. (20 cm)	Single	CAV	14 min
					CLV	20 min
		8-inch LD	8 in. (20 cm)	Double	CAV	28 min
					CLV	40 min
		12-inch LD	12 in. (30 cm)	Double	CAV	1 hr
					CLV	2 hr
Compact Discs For music		CD Single	3 in. (8 cm)	Single	20 min	
		CD	5 in. (12 cm)	Single	74 min	
Compact Disc Videos For music videos and educational material (Digital Audio)	 	CDV	5 in. (12 cm)	Single	Video+Audio	5 min
					Audio	20 min
		VSD	5 in. (12 cm)	Single	Video+Audio 5 min	

Multi audio discs



Discs with these logos contain separate analog and digital tracks which may differ in content.

* The MDP-550 cannot play the following discs or functions:

- CED, VHD discs or PAL video discs
- CD-ROM, CD-Graphics, Video CD, Photo CD, CD-I discs
- Aluminum-lined discs or MD (MiniDisc) discs
- Graphic functions of LD-G discs

Optical disc maintenance

Holding CDs or CDVs

Hold CDs or CDVs by putting your index finger through the center hole and grasping the edge of the disc with the thumb and other fingers as shown in the illustration.

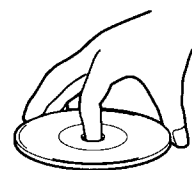

Holding LDs

Hold LDs by grasping the outside edge with both hands as illustrated.

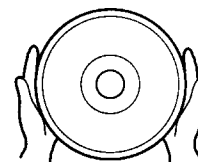

Light exposure

Do not expose the disc to direct sunlight or heat sources such as hot air ducts, or leave the disc in a car parked in direct sunlight where there can be a considerable rise in temperature.

Cracked or damaged discs

Do not play cracked or damaged discs, or try to play discs that have been repaired with adhesive glues.

Keeping the disc surface clean

Clean the surface of the disc before playing, using a soft, dry, cleaning cloth. Wipe the disc from the center out. Do not use solvents such as benzene, paint thinner, commercially available cleaners, or anti-static spray intended for LP record discs.

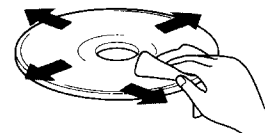

To prevent marring, after playing, remove the disc and put it back into its jacket. Putting your fingers on, or adhering anything to the surface of the disc such as sticky note pad paper or adhesive tape will deteriorate the quality of the playing surface, and thus the output quality.









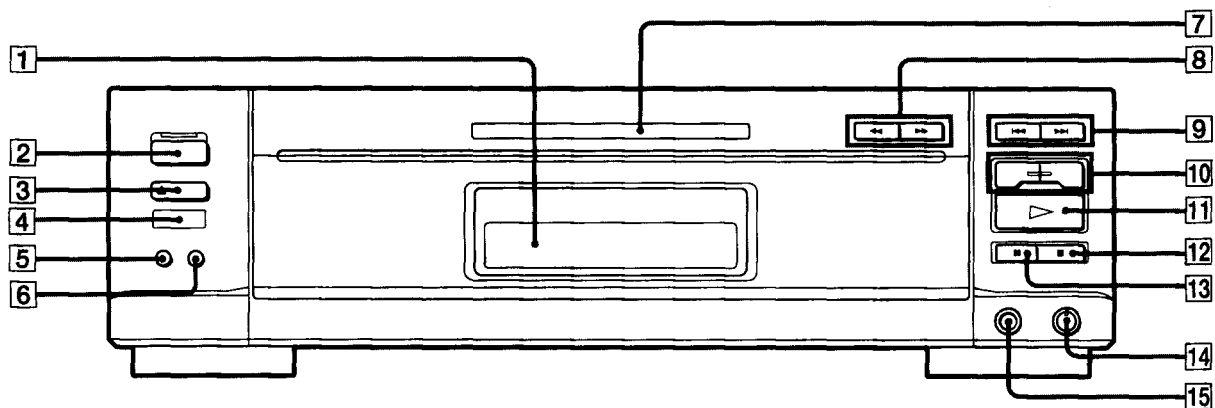

Index to parts and controls

See the pages indicated in () for details.

Front



- 1** Front panel display (9)
- 2** POWER switch and indicator (8)
ON: Green
OFF: Off
- 3**  OPEN/CLOSE button (8)
- 4** Remote sensor (25)
- 5** QUICK START button and indicator (11)
- 6** FL DISPLAY button (9)

- 7** AUTO RESUME indicator (10)
- 8**  /  SCAN buttons (12)
- 9**  /  ACS/AMS buttons (12)
- 10** SIDE A/B buttons and indicators (9)
- 11**  (Play) button (8)
- 12**  (Stop) button (8)
- 13**  (Pause) button (8)
- 14** ECHO/MIC LEVEL controls (23)
- 15** MIC jack (23)

Index to parts and controls (continued)

Remote commander

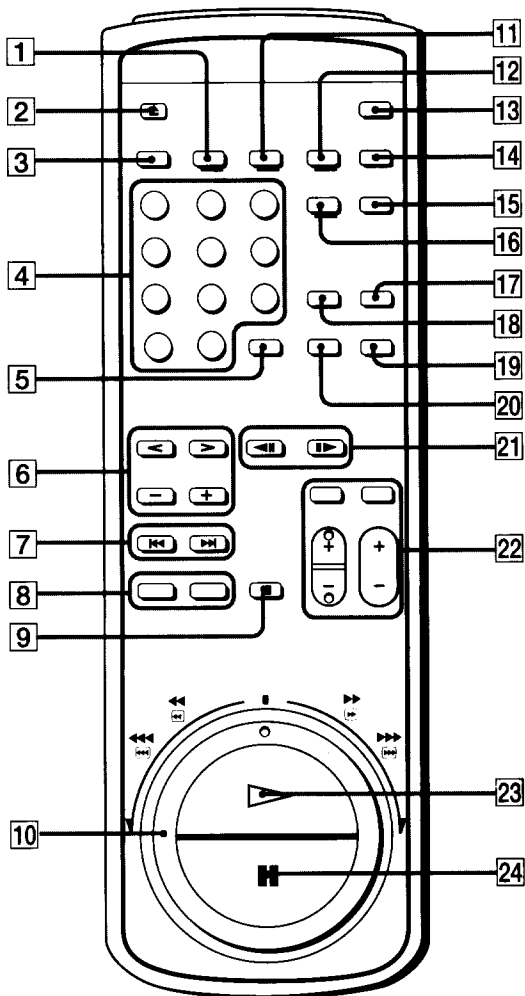

- 1 FRAME/TIME button (17)
- 2 ▲ OPEN/CLOSE button (8)
- 3 CLEAR button (17) (20) (22)
- 4 Number buttons (16) (17) (20) (24)
- 5 SEARCH/NEXT button (17) (20)
- 6 MULTI SPEED </>, SPEED SET +/- buttons (19)
- 7 <<</>>> ACS/AMS buttons (12)
- 8 DISC SIDE A/B buttons (9)
- 9 ■ STOP button (8)
- 10 SHUTTLE ring (12)
- 11 PGM button (20)
- 12 REPEAT button (22)
- 13 POWER switch (8)
- 14 DISPLAY button (14)
- 15 AV TIME button (15)
- 16 1/SIDE/ALL button (9) (16) (22)
- 17 ANALOG button (13)
- 18 ◻ (CX) button (13)
- 19 AUDIO MONITOR button (13)
- 20 BACK button (20)
- 21 <||/||> STILL/STEP buttons (18)
- 22 TV control buttons
(available for TVs which have ■ mark)
- 23 ▷ PLAY button (8)
- 24 || PAUSE button (8)

A function activated by pressing a button with an orange mark (illustrated as "◻") can be canceled by pressing the CLEAR button.

Index

A, B

- Accessories supplied 5
- ACS/AMS 12
- All disc repeat 22
- ATT switch 24
- Auto resume 10
- AV calendar 9, 14

C

- CAV disc 17
- CDV disc 27
- CLV disc 17
- Chapter search 16
- Checking operating status
 - on the front panel 9
 - on TV screen 14
- Connecting
 - an amplifier 7
 - a microphone 23
 - a TV or a VCR 6
 - with optical fiber cable 7
 - with S video cable 7

D

- Disc
 - classification 27
 - maintenance 28

E

- Entering a number over 10 16

F, G, H, I, J

- Frame search 17
- Freeze frame 18

K

- Karaoke 23

L

- Loading a disc 8

M, N

- Multi speed play 19

O

- One side repeat 22
- Opening the disc tray 8
- Optical disc types 27

P

- Play 8
 - at various speeds 19
 - either side of an LD 9
 - frame-by-frame 18
 - freeze frame 18
 - pause 8
 - programed chapters/tracks 20
 - resume 10
 - stop 8
- Power 8
 - turning on/off 8
- Program play 20

Q

- Quick start 11, 21

R

- Repeat play 22
 - current chapter/track 22
 - one side of an LD 22
 - whole disc 22
- Remote commander 5, 25
 - inserting batteries 5

S

- Searching
 - by chapter/track number 16
 - by frame/time number 17
 - by variable speed scan 12
 - skipping chapters/tracks 12
- Single repeat 22
- Skip search 12
- Sound
 - alternating 13
 - analog 13
 - digital 13
 - on SAP discs 13
 - with CX noise reduction system 13
- Step play 18

T, U

- Time search 17
- TOC data 11
- Track search 16
- Troubleshooting 25

V, W, X, Y, Z

- Variable speed scan 12