

CD CDV LD Player

MDP-600

MDP-A1

Operating Instructions

Before operating the unit, please read this manual thoroughly and retain it for future reference.

For the Customers in the USA

Owner's Record

The model number is located on the rear panel. The serial number is located on the top of front panel. Record the model number and the serial number in the space provided below. Refer to them whenever you call upon your Sony dealer regarding this product.

Model No. _____ Serial No. _____

WARNING

To prevent fire or shock hazard, do not expose the unit to rain or moisture.

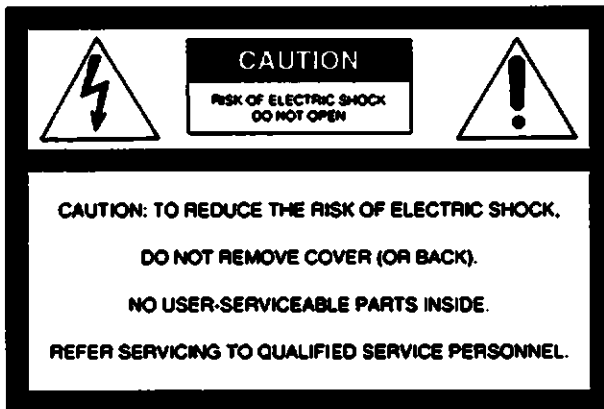

This symbol is intended to alert the user to the presence of uninsulated "dangerous voltage" within the product's enclosure that may be of sufficient magnitude to constitute a risk of electric shock to persons.



This symbol is intended to alert the user to the presence of important operating and maintenance (servicing) instructions in the literature accompanying the appliance.

For detailed safety precautions, see the leaflet "IMPORTANT SAFEGUARDS".

INFORMATION

You are cautioned that any changes or modifications not expressly approved in this manual could void your authority to operate this equipment.

NOTE: This equipment has been tested and found to comply with the limits for a Class B digital device, pursuant to Part 15 of the FCC Rules. These limits are designed to provide reasonable protection against harmful interference in a residential installation. This equipment generates, uses, and can radiate radio frequency energy and, if not installed and used in accordance with the instructions, may cause harmful interference to radio communications. However, there is no guarantee that interference will not occur in a particular installation. If this equipment does cause harmful interference to radio or television reception, which can be determined by turning the equipment off and on, the user is encouraged to try to correct the interference by one or more of the following measures:

- Reorient or relocate the receiving antenna.
- Increase the separation between the equipment and receiver.
- Connect the equipment into an outlet on a circuit different from that to which the receiver is connected.
- Consult the dealer or an experienced radio/TV technician for help.

CAUTION

The use of optical instruments with the product will increase eye hazard.

As the laser beam used in this videodisc player is harmful to the eyes, do not attempt to disassemble the cabinet. Refer servicing to qualified personnel only.

NOTICE FOR THE CUSTOMERS IN CANADA

This apparatus complies with the Class B limits for radio noise emissions set out in radio Interference Regulations.

CAUTION:

TO PREVENT ELECTRIC SHOCK, DO NOT USE THE POLARIZED AC PLUG WITH AN EXTENSION CORD, RECEPTACLE OR OTHER OUTLET UNLESS THE BLADES CAN BE FULLY INSERTED TO PREVENT BLADE EXPOSURE.

Table of Contents

	About Operating Voltage	4
Introduction	About These Instructions	5
	What to Do First	6
	The Principles of Operation	6
	Introduction to Your Player	7
Installation and Connection	Front and Rear Panel Controls and Supplied Accessories	8
	Controls on the Remote Commander	10
	How to Connect the Television	11
	How to Connect Audio Equipment	13
To Play a Laser Disc	How to Load and Play an LD (Laser Disc)	14
	Understanding Displays and Messages When Playing LDs	17
	How to Search Using Variable Speed Play (for CAV discs)	18
	How to Search by Chapter Numbers	19
	How to Search by Frame Number or Time—Frame/Time Search	20
	How to Replay the Same LD Selections	21
	How to Play Only Certain Chapters—Programmed Play	23
	How to Play Frame-by-Frame (for CAV discs)	25
	How to Continue Play from the Point You Stopped at—Memory Play ...	25
To Play a Compact Disc	How to Load and Play a CD (Compact Disc)	26
	Understanding Displays and Messages When Playing CDs	28
	How to Locate a Certain Track	29
	How to Search by Elapsed Playing Time—Time Search	30
	How to Replay the Same CD Selections	31
	How to Play Only Certain Tracks—Programmed Play	32
To Play a Compact Disc Video	How to Load and Play a CDV (Compact Disc Video) or VSD (Video Single Disc)	33
	Understanding Displays and Messages When Playing CDVs or VSDs	34
To Play Any Disc	How to Have the Disc Play Within a Set Period of Time	35
	How to Display the Elapsed Playing Time — Time Counter	36
	How to Program the Player to Pause or Scan Automatically	37
	How to Play Selections in Random Order—Shuffle Play	38
To Play Karaoke	42
Additional Information	Troubleshooting	44
	Optical Disc Maintenance	45
	Player Maintenance and Safety	45
	Glossary	46
	Specifications	47
Index	Specifications	Back cover

About Operating Voltage

Before operating the Multi Disc Player, make sure that the operating voltage of your unit is identical with that of your local power supply.

How to Determine the Correct Operating Voltage

- **MDP-600**

The MDP-600 operates at 120 V AC 60 Hz only and does not have a voltage selector.

- **MDP-A1**

The MDP-A1 has a voltage selector.

Before operating the unit, find out the local voltage, and if necessary reset the selector at the rear of the Multi Disc Player to the voltage corresponding to your local power supply (120, 220 or 240 volts AC). The voltage selector of this unit is set to 120 V AC originally. When using in Malaysia, reset the selector to 240 V AC.

To reset the voltage selector, disconnect the power cord and turn the selector with a blade screwdriver so that the arrow on the rear panel points to the appropriate voltage.

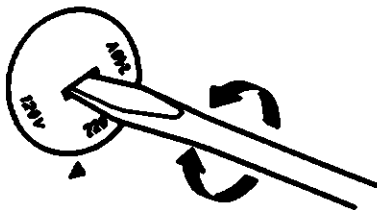

How to Use the AC Power Plug Adaptor (supplied with the MDP-A1)

- If the AC plug on your Multi Disc Player does not fit into the wall outlet, attach the supplied AC plug adaptor.

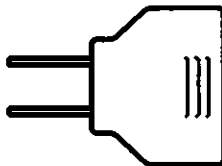

If you have any questions or problems concerning your unit, please contact your nearest Sony dealer.

Introduction

This introduction explains the organization of this manual and the principles of operation of the Multi Disc Player (MDP).

About These Instructions

Consumer electronics manuals have been notorious for being hard to comprehend. Having recognized this fact, we have made an attempt with this manual to avoid the usual pitfalls by trying to not pretend that the equipment being described is as simple as a bread toaster. Most likely this is your first Multi Disc Player and may be the only one you will own. With that in mind, we have striven to write the instructions in straight-forward English while trying to keep the procedures simple and systematic.

Differences between the MDP-600 and MDP-A1

This manual covers both the MDP-600 and MDP-A1. Their differences are as follows:

Front panel

- (LD) QUICK START button and indicator In the MDP-600 the button is referred to as the QUICK START button, however, in the MDP-A1 the button is referred to as the LD QUICK START button. In this manual, we use QUICK START.

Rear panel

- Voltage selector The MDP-A1 has a voltage selector (see page 4).
- RFU OUT connectors The MDP-A1 has RFU connectors (see page 9).
- AC IN connector Each model has a different AC IN connector.

The illustrations of the rear panel in this manual are of the MDP-A1.

Supplied accessories

- Remote Commander RMT-M19A is supplied with the MDP-600. RMT-M19B is supplied with the MDP-A1. RMT-M19B has the DISC/TV button.
 - AC power cable Each model has different plugs.
 - AC plug adaptor Supplied with the MDP-A1 only (see page 4).
-

Because the Multi Disc Player is capable of playing laser discs (LDs), compact discs (CDs), and compact disc videos (CDVs), these instructions are divided into the equivalent of three "manuals"—one for each type of disc—with a fourth section providing instructions common to all discs and the fifth section for enjoying Karaoke.

The following summarizes what you'll find in this manual.

To Play a Laser Disc (LD)

This section covers all functions associated with playing LDs (page 14). Unique to LD play are STILL/STEP, MULTI SPEED play, MEMORY play and FRAME/TIME search. The MDP-600/A1 allows you to playback both sides of an LD without replacing it. The (LD) Quick Start function shortens the waiting time before an LD starts playing.

To Play a Compact Disc (CD)

This section explains the operation of CDs and compares most closely to CDV audio operations (page 26).

To Play a Compact Disc Video (CDV)

This section covers procedures for CDV operation and shares many functions with CD play (page 33). There are no functions unique to CDV play in this Multi Disc Player.

To Play Any Disc (LD, CD, CDV)

Most of the procedures in this section fall into the advanced category (page 35) and are collected here because they are common to LD, CD and CDV play.

To Play Karaoke

This section is a short instruction for Karaoke playing (page 42).

What to Do First

Once you have read through this page, read "Principles of Operation" (page 6), then go ahead and connect up the Multi Disc Player to your television and/or stereo system using the connection diagrams on pages 11, 12 and 13. After you have done this, you will be ready to play a disc. We suggest an LD or CD. Begin with the section, "How to Load and Play an LD (or a CD)".

The Principles of Operation

Beyond the play of discs, the functions of the Multi Disc Player range from simple to advanced. Some functions vary depending on what type of disc (laser disc, compact disc, or compact disc video) you are playing. Nevertheless, keep in mind that the majority of the buttons have been designed to achieve a comparable effect for each type of disc you are playing. Therefore, the following paragraphs can briefly summarize what the basic Multi Disc Player functions allow you to do. (Control names that differ from the function name appear in uppercase letters.)

Primary Functions

are so-called because they entail the traditional functions of all disc players.

Variable Speed

group operations according to the fact that they let you vary play speed, therefore, easily locate ("search") scenes or tracks as you watch or listen.

Repeatable Functions

are memory functions that let you play selections repeatedly, according to a play list or randomly. Playback can be started from the point you stopped. Because the system finds and plays selections according to your request, some repeatable functions also serve as "search" functions.

Auxiliary Functions

are additional functions that simply add to what you can do with the Multi Disc Player.

Primary Functions

Variable speed Functions

Repeatable Functions

Auxiliary Functions

Power
Open/Close
Play
Pause
Stop
Side A (B)

Variable Speed Scan
(SHUTTLE RING)
Still/Step Scan
(STILL/STEP)
Variable Speed Play
(MULTI SPEED,
SPEED SET)

Pre-Programmed Play
(AUTO PGM, PGM)
Intro Scan (INTRO)
Random Play
(SHUFFLE)
Chapter/Track Search
(ACS/AMS)
Frame/Time Search
(FRAME/TIME)
Memory Play
(MEMORY PLAY)
Auto Pause
(AUTO PAUSE)
Repeat Play
(1/SIDE/ALL, REPEAT,
REPEAT A↔B)





Picture Enhance Functions:
(PICTURE ENHANCE)
Sound Quality Functions:
(AUDIO MONITOR,
ANALOG, CX)
On-Screen Display
(DISPLAY)
Audio/Video Time Counter
(AV TIME)
Karaoke Functions:
(ECHO/MIC LEVEL)

Introduction to Your Player

The MDP-600/A1 Multi Disc Player integrates the functions of three machines into one: laser disc, compact disc, and compact disc video player. The entertainment potential afforded by the combined capabilities of this multi-faceted machine amounts to some 40 to 45 functions. Below follows an explanation of the kinds of discs the Multi Disc Player plays.

The MDP-600/A1 Plays Three Classes of Optical/Digital Discs*

The MDP-600/A1 Multi Disc Player plays all three types of optical discs currently available for home entertainment. The following table illustrates their types and features.

Disc Class	Disc Logo	Disc Type	Size	Play Side	Play Time	
Laser Discs For movies, operas, and concerts	 LASER DISC  LASER DISC	LD Single	8 in. (20 cm)	Single Side	CAV	14 min
					CLV	20 min
		8-inch LD	8 in. (20 cm)	Double Side	CAV	28 min
					CLV	40 min
		12-inch LD	12 in. (30 cm)	Double Side	CAV	1 hr
					CLV	2 hr
Compact Discs For music	 COMPACT DISC DIGITAL AUDIO	CD Single	3 in. (8 cm)	Single Side	20 min	
		CD	5 in. (12 cm)	Single Side	74 min	
Compact Disc Videos For music videos and educational material (Digital Audio)	 CD VIDEO	CDV	5 in. (12 cm)	Single Side	Video+Audio	5 min
					Audio	20 min
	 VIDEO SINGLE DISC	VSD	5 in. (12 cm)	Single Side	Video + Audio	5 min

Multi Audio Discs



On laser discs bearing this logo, the analog tracks are recorded in multiplex, and the digital tracks are recorded in stereo.

* These apply only to those discs recorded in the NTSC standard. The MDP-600/A1 cannot play CED, VHD discs or PAL video discs, CD-ROM, CD-GRAPHICS, CD-I discs or aluminum-lined discs.

Installation and Connection

Front and Rear Panel Controls and Supplied Accessories

Front Panel

FL DISPLAY button

Each time you press the button, the front panel display turns on/off.

QUICK START (MDP-600)

LD QUICK START (MDP-A1) button and indicator
To turn off the indicator, press the button while in the stop mode. (See page 16.)

POWER (ON/OFF) button and indicator

ON: Green
OFF: Off (MDP-600)
Red (MDP-A1)

Remote Commander Sensor

PHONES jack and LEVEL control

To listen with headphones, plug stereo headphones into the PHONES jack. Adjust the volume with the LEVEL control.

Front Cover

Automatically slides down when you press the OPEN/CLOSE (▲) button, and the disc tray comes out.

◀▶ SCAN buttons

Press the right button to scan forward; press the left button to scan backward.

◀▶▶▶ ACS/AMS buttons

Press the right button to advance one chapter/track; Press the left button to go back a chapter/track.

SIDE A/SIDE B button and indicators

Press the upper or lower side of the button to select the playing side of an LD.

▲ OPEN/CLOSE button

▶ PLAY button

|| PAUSE button

■ STOP button

MIC jack and ECHO/MIC LEVEL controls

To play Karaoke, plug a microphone into the MIC jack. Adjust the microphone volume and echo level with the controls.

Front Panel Display

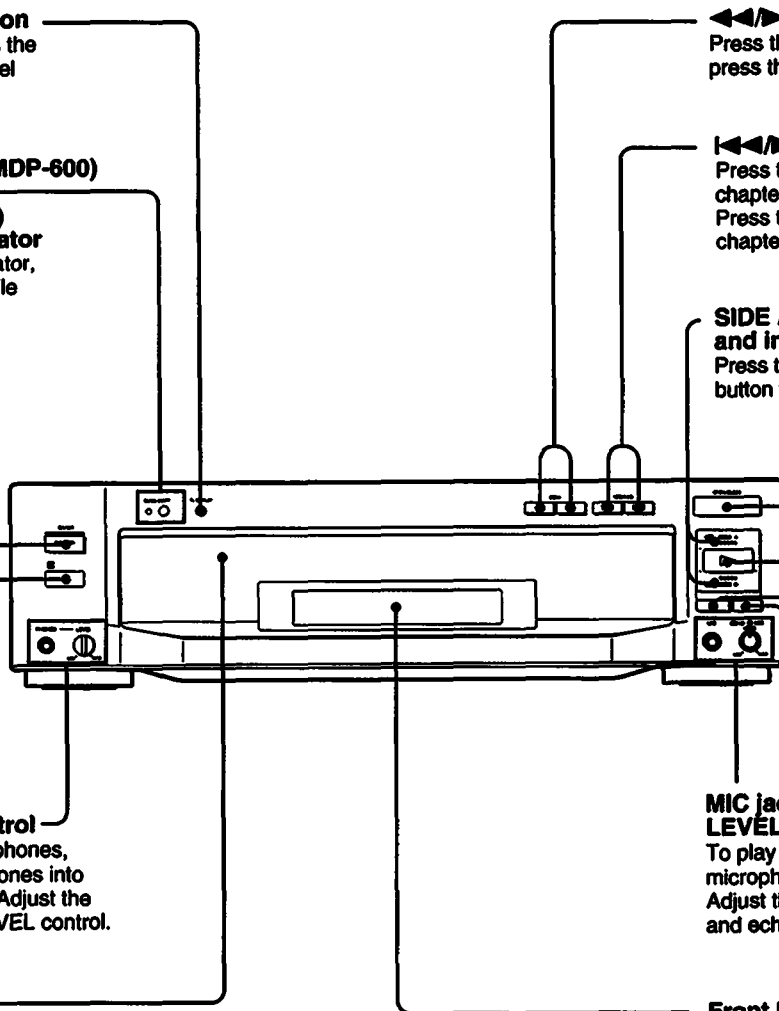

Rear Panel

S VIDEO OUT 1, 2

Connect the YC-15V Cable (not supplied).

LINE OUT 1, 2

Audio Connectors

ATT (Attenuator) switch

Distorted singing sounds can be corrected by setting this switch to ON. This will lower the volume.

Voltage selector
With the MDP-A1 only
(See page 4.)

RFU OUT Audio/Video Connectors

These connectors are on the MDP-A1 only. Connect the RFU adaptor when your TV does not have Audio/Video inputs (see page 12).

AUDIO OUT (MONO) jack

(phono jack)

RFU DC OUT jack

(mini mini jack)

This jack supplies power to the RFU adaptor.

VIDEO OUT jack (phono jack)

LINE OUT 1, 2

Video Connectors

DIGITAL OUT

Fiber Optical Connector

AC IN connector
Connect the AC power cable (supplied).

CONTROL S IN jack (mini type)

Use this jack if your TV etc. has a CONTROL S output jack.

- By connecting this jack to the CONTROL S output jack on your TV, you can control this player with the Remote Commander pointed at the TV.
- Connect the RK-G69 cable (not supplied).
- If you plug one end of the cable into the player and leave the other end unplugged, the Remote Commander will not work.

AC IN-

MDP-600

Accessories

Make sure the shipping box contains the following accessories:

RMT-M19A Remote Commander
(RMT-M19B supplied with the MDP-A1)

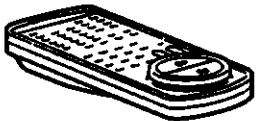

Two AA (R6) batteries



Audio/Video connecting cable
(phono 3 ↔ phono 3)



AC plug adaptor
supplied with the MDP-A1
(See page 4.)

AC power cable

The plugs for the AC power cable of the MDP-A1 differ from the plugs of the MDP-600 (shown below).



Controls on the Remote Commander

You can use the Remote Commander (Remote) to control the player or the identical buttons on the player itself.

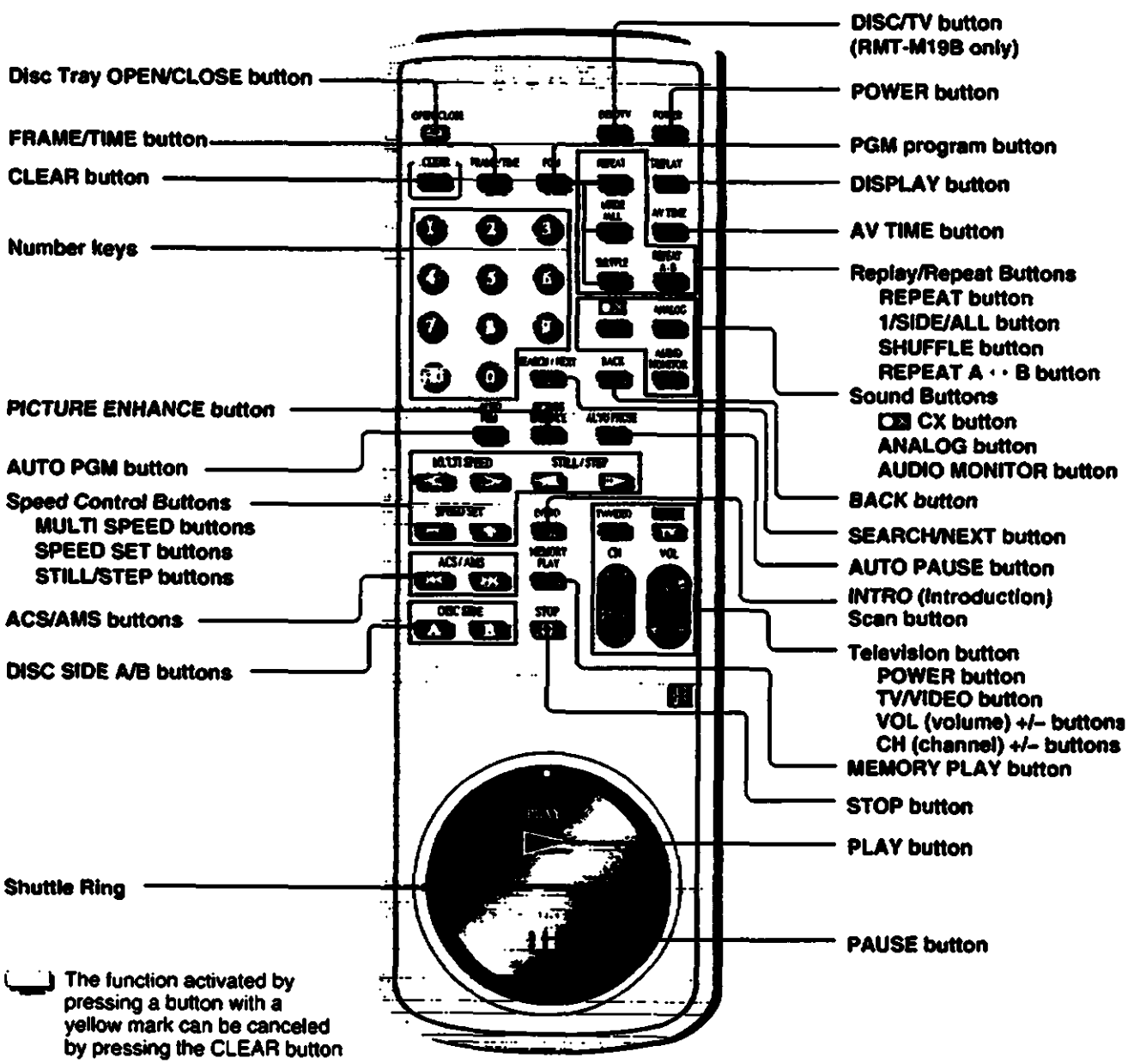

To Activate the Remote Commander

Open the back cover, and insert two size AA (R6) batteries according to the polarity indicated in the illustration. The batteries will last for about 6 months. If the range of the Remote Commander becomes noticeably short, replace all the batteries with new ones. If the Remote Commander is not to be used for a long time, remove the batteries to avoid damage from possible battery leakage.

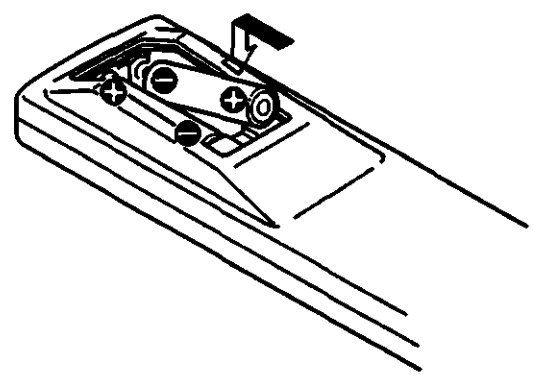

Insert two size AA (R6) batteries

Remote Commander Precautions

- Do not let sunlight or powerful artificial light fall directly on the Remote Commander sensor on the front panel (of the player) as it may interfere with Remote Commander operation.
- Use size AA (R6) batteries only.

How to Connect the Television

To play LDs or CDVs, hook up a television to the Multi Disc Player. Take out the supplied audio/video connecting cable (yellow, red and white plugs). Use this to connect the player to the television.* Once you have hooked-up the television, set the input selector on the TV to "Video". Before connecting or disconnecting any of the cables, turn off all equipment.

Television Hook-Up

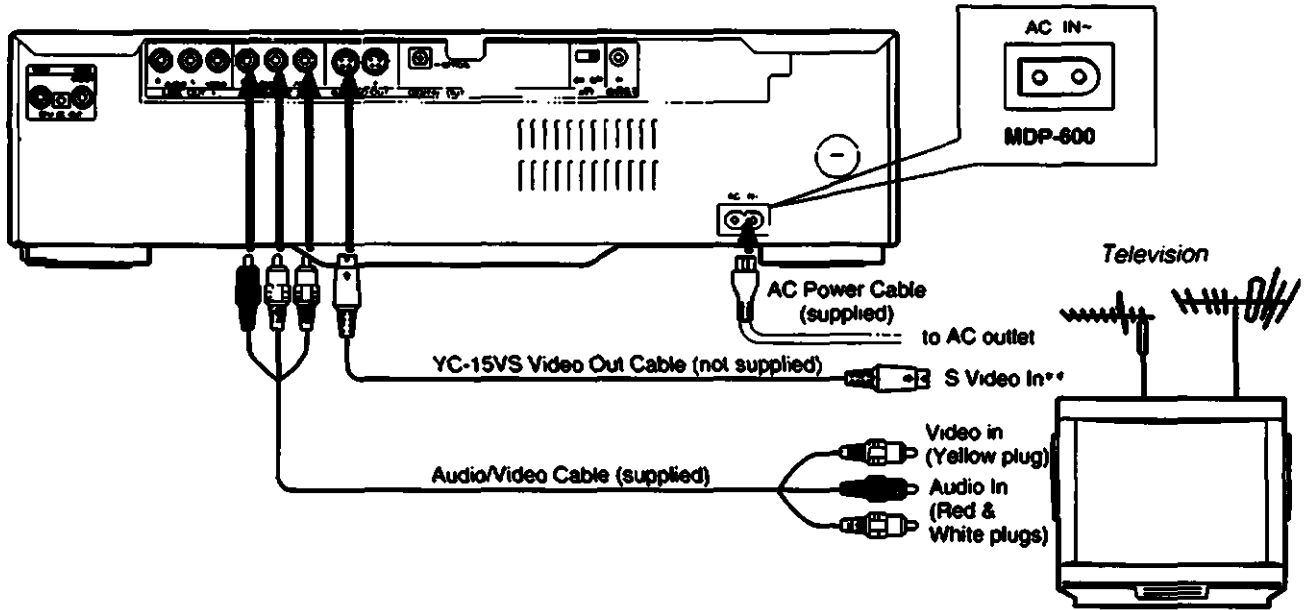

Television/VCR Hook-Up

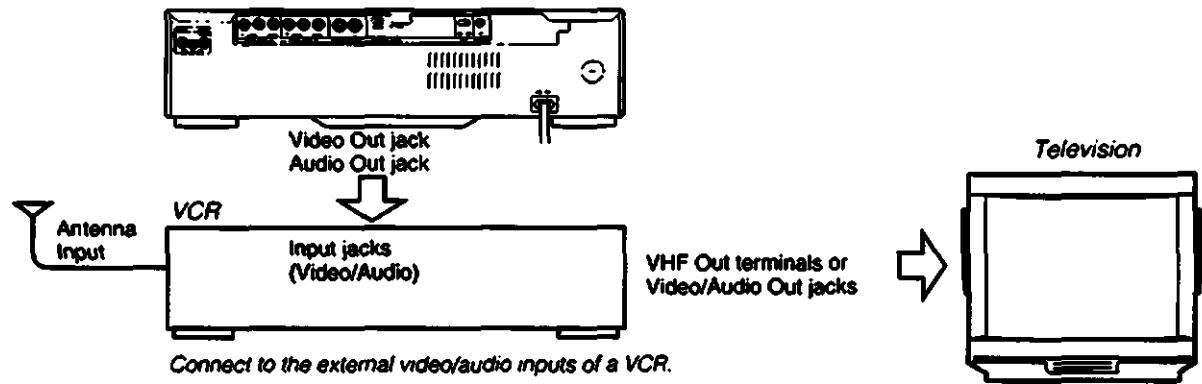

Connecting Precautions:

- Make sure all equipment is turned off before connecting or disconnecting any cables.
- Connection methods may differ; when in doubt about a connection consult the TV or VCR manufacturer's manual.
- If the sound or picture is disturbed by noise, try moving the equipment farther apart.
- Firmly insert plugs into the jacks. A loose connection may cause noise.
- To prevent later interference with TV broadcast reception, turn off all equipment connected but not currently in use.

- * If the TV only has a monaural phono jack for audio input, use a VMC-910MS/915MS Connecting Cable (not supplied).
- ** If your TV has an S Video Input jack, obtain a YC-15V S Video Connecting Cable, and use this instead of the supplied video cable to connect your television to the S VIDEO OUT connector on the Multi Disc Player.

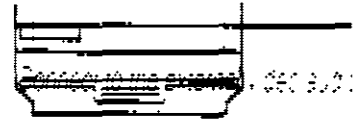
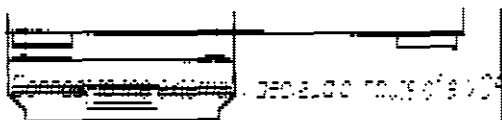

If Your TV Does Not Have Audio/Video Inputs (MDP-A1 only)

For connection, use the optional RFU-90UC (RFU adaptor).

The audio signal of the disc is reproduced in monoaural when connected to the TV via the RFU-90UC. To enjoy the disc in stereo, connect the player to an audio system (page 13).

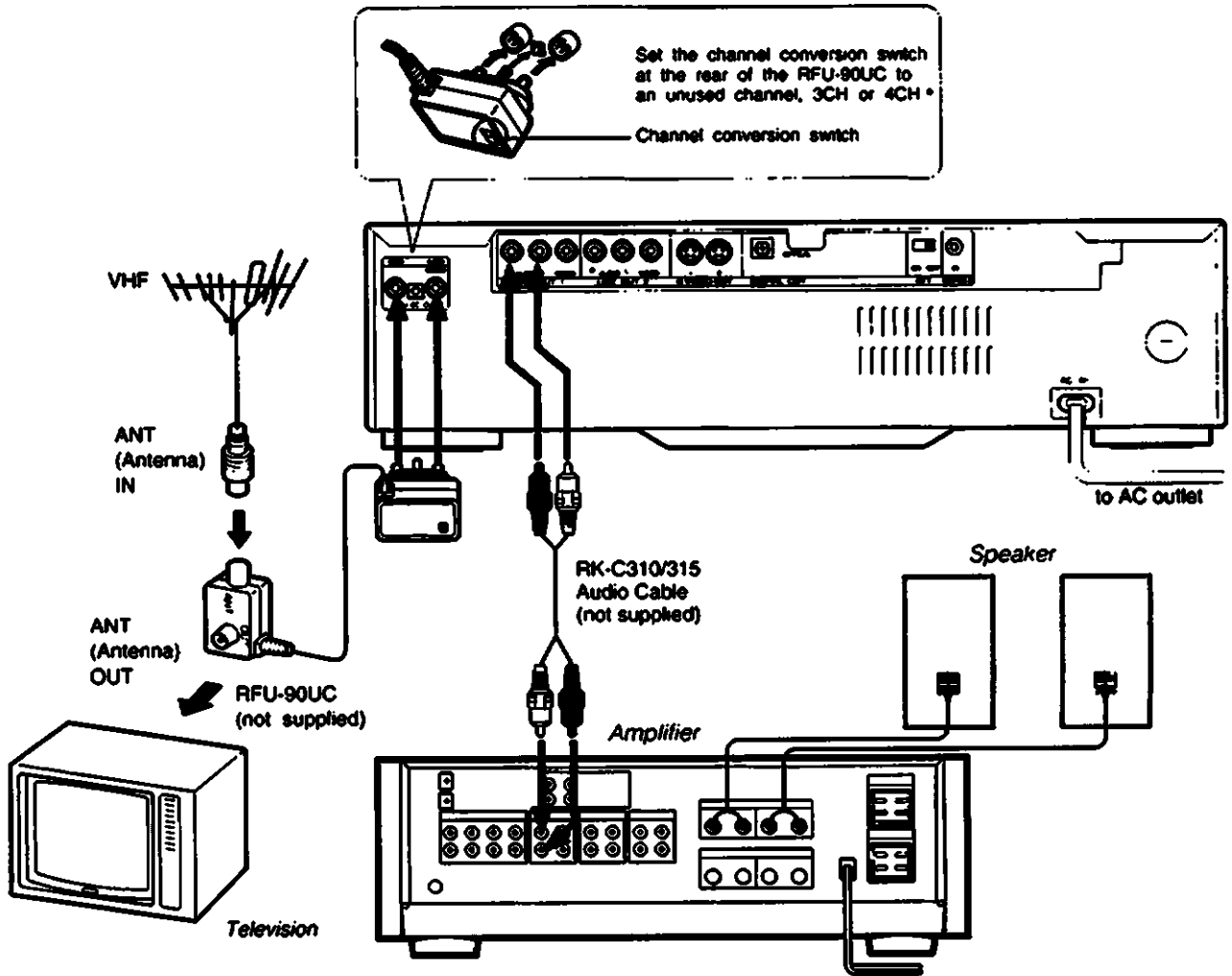

Note on Connection:

One of the most important of your Multi Disc Player is its digital stereo sound (from either LD's or CD's). To get the advantage of stereo sound, hook your player's L/R audio outputs to a stereo audio system or stereo TV. In addition, by using the video output jack, you will get a noticeably better picture. To connect this player to a TV without AV inputs, use an RFU-90UC adaptor (not supplied). However, if you connect your Player this way, you will not get stereo sound, and the picture quality will not be as good as it could be.

• Why is it necessary to select 3 or 4?

The Multi Disc Player sends its output to the TV as a VHF broadcast signal. Selection an unused channel avoids interfering with regular broadcasts. When watching regular TV programs, turn the player off or press the DISC/TV button on the Remote Commander so that you can obtain a better picture. If TV picture quality is not satisfactory, refer to the manufacturer's manual and adjust the reception.

When watching TV broadcast.

Always turn off the Multi Disc Player to get better reception.

During FM or AM reception

Turn off the power of the Multi Disc Player to prevent the possibility of noise interference.

How to Connect Audio Equipment

To achieve full stereo sound from your Multi Disc Player, hook up a stereo system following the diagram below. Use an RK-C310 (or RK-C315) audio connecting cable (not supplied) to connect the Multi Disc Player to your amplifier or receiver. Before connecting or disconnecting any of the below cables, turn off all equipment.

To Achieve Digital Sound

Digital sound recordings afford high quality sound reproduction, (see Glossary, page 46). If your amplifier also has a fiber optical connector, or if you have a D/A converter unit with optical input, according to the diagram below, connect the POC-15 Audio Fiber Optical Cable (not supplied) between the DIGITAL OUT connector on the Multi Disc Player and the amplifier or D/A converter. Note that digital signals are always output from the Multi Disc Player except when you play discs that are not digitally recorded. Such discs output analog sound from LINE OUT only.

Sound from a microphone cannot be output from the DIGITAL OUT connector. To output sound from a microphone, connect the player to the amplifier with an Audio Cable (Red & White plugs).

Audio Equipment Hook-Up

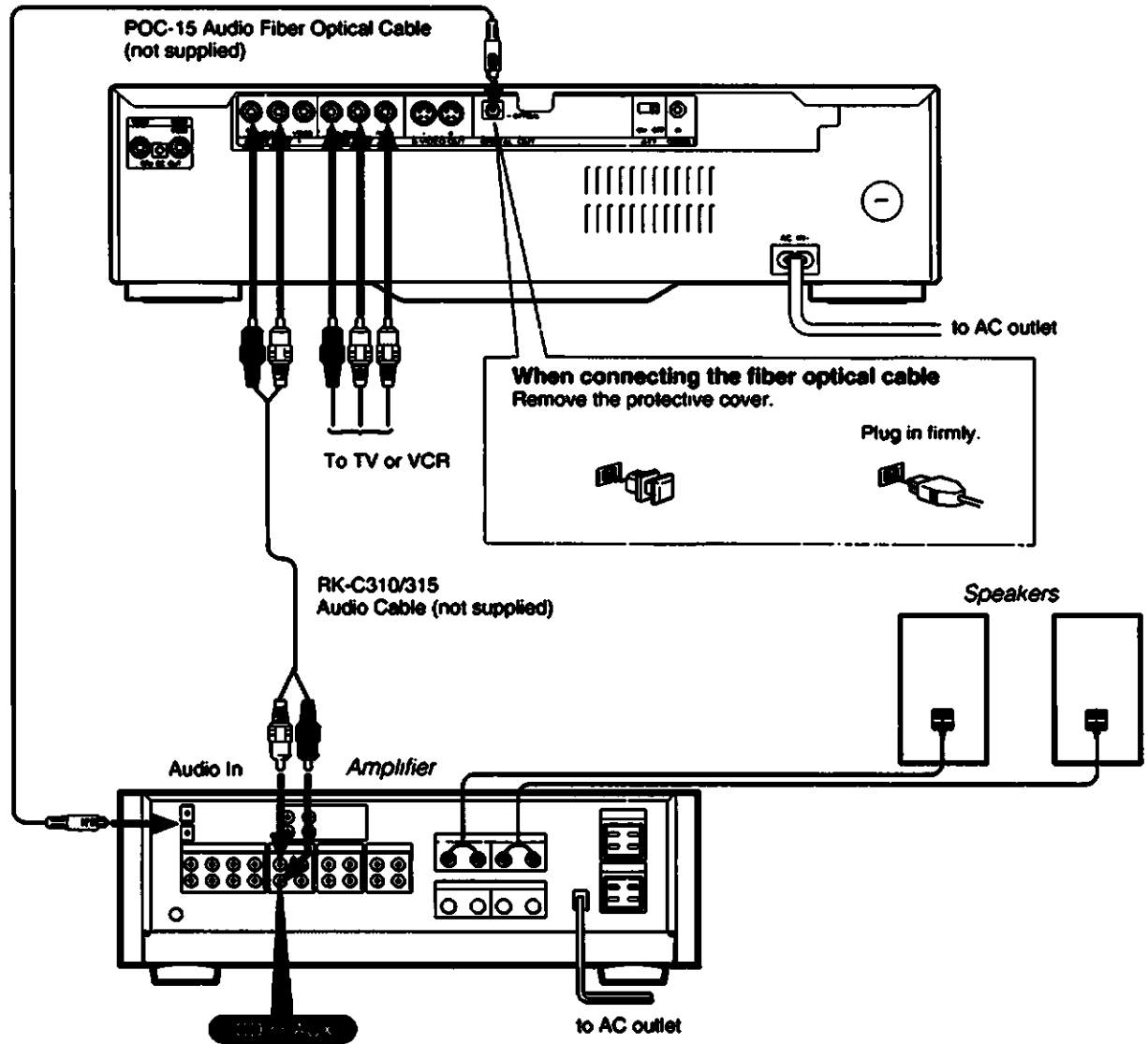

Connection Precautions

- Make sure all equipment is turned off before making any of the above connections.
- Firmly insert plugs into the jacks. A loose connection may cause noise.
- When listening to a radio broadcast, switch off the Multi Disc Player to get better reception.

To Play a Laser Disc

This section shows you how to conduct all the procedures associated with playing LDs.

How to Load and Play an LD (Laser Disc)

After you have connected the Multi Disc Player to the TV and/or stereo system, you can begin playing a laser disc. Locate the POWER, OPEN/CLOSE, and PLAY buttons on the Remote Commander or the front panel of the player.

Do not transport the player while playing a disc as it may cause damage to the disc.

- 1 Turn on the multi disc player.

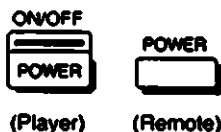

Press the POWER button on the player or Remote commander.

- 2 Turn on the TV and stereo system.

TV. Set the input selector on the TV to "Video". Stereo System. Turn on the amplifier or receiver and select CD or AUX for audio output.

- 3 Open the disc tray.

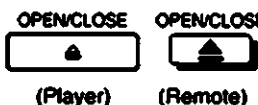

Press the OPEN/CLOSE (▲) button. The front cover of the player slides down and the disc tray comes out.

- 4 Place a disc on the tray.

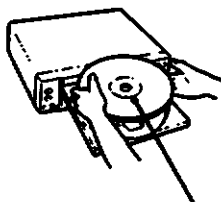

Carefully center a single disc on the tray. If you insert more than one disc, or if the disc is not seated properly, it may not play or it may damage the disc.

What is this indication?

NO DISC

Side A*

This indication appears in the front panel display when the tray is empty.

- 5 Start playback.

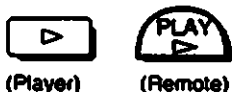

Press the PLAY (▶) button.** The disc tray closes and the upper side of the disc starts playing.

To Advance or Reverse



Hold down the SCAN (◀▶) button on the player or rotate the Shuttle Ring on the Remote.



(Remote)

To Advance or Go Back a Chapter at a Time

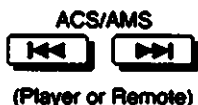

Press the ACS/AMS (◀▶) button.

* The player determines that the upper side of the disc is side "A," and the other side is "B," regardless of the label "A" or "B" printed on the disc.

** When playback of the upper side of the disc (side A) ends, the other side (side B) starts playing automatically. If nothing is recorded on side B, playback stops.

To Select the Disc Side



(Player)



(Remote)

Press (DISC) SIDE A to play the upper side of the disc from the beginning.

Press (DISC) SIDE B to play the other side of the disc from the beginning.*

To Interrupt Play



(Player)



(Remote)

Press PAUSE (II). The sound mutes, and the picture freezes when playing a CAV disc.** To resume playback, press PAUSE (II) or PLAY (▶).

To Stop Playback



(Player or Remote)

Press STOP (■).

To play again from the beginning of the disc, press PLAY (▶).

To Stop Play and Remove the Disc



(Player)



(Remote)

Press OPEN/CLOSE (⏏). Remove the disc and press ⏏ again to close the empty tray.

To Have the Player Pause Before Starting



(Player)



(Remote)

Press PAUSE (II) after doing step 4 on page 14.

The tray closes and the player waits at the start of the disc until you press PLAY (▶) or PAUSE (II). If you want to play side B, press (DISC) SIDE B, then PAUSE (II).

To Get Sharp/Soft Image

PICTURE ENHANCE



(Remote)

Press PICTURE ENHANCE on the Remote to select the mode. The selected mode appears on the TV screen (lower left-hand corner) for three seconds. Each time you press this button the mode changes in the order of STANDARD, SHARP and SOFT.

SOFT: Soft picture

Reduces screen noise

STANDARD: Standard picture

SHARP: Sharp picture

Refines the images

Even if you turn off the power, the mode will remain stored in the player's memory. If you unplug the power cord, the mode will return to STANDARD.

* When playback of side B ends, the player stops playing.

** When playing a CLV disc, the TV screen goes blank.

To Play a Stereo LD or a Second Audio Program (SAP) LD

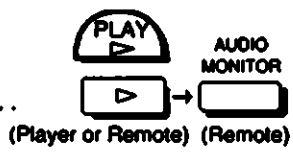

Press **PLAY (▶)**, then press the **AUDIO MONITOR** button on the Remote. This function alternates the sound output on a disc that has been recorded on two sound tracks, such as bilingual discs.

The procedure below indicates how the output and the display changes with each press. The active track appears for three seconds on the TV screen. It always appears in the front panel display.

Procedure	Screen message	Output Sound	
		Stereo Disc	SAP Disc
1 Press PLAY (▶) .	No message	Stereo (Both channels)	Soundtrack 1 (left channel) Soundtrack 2 (right channel)
2 Press AUDIO MONITOR .	1/L	Left channel	Soundtrack 1 (left channel)
3 Press AUDIO MONITOR again.	2/R	Right channel	Soundtrack 2 (right channel)
4 Press AUDIO MONITOR again to return to stereo status.	1/L 2/R	Stereo (Both channels)	Soundtrack 1 (left channel) Soundtrack 2 (right channel)





To Switch from Digital to Analog Sound



Press the **ANALOG** button on the Remote to switch the player to analog or digital sound. Digital affords a better quality sound reproduction. If the LD contains a digital sound signal, the player automatically sends that output to the amplifier or receiver. When you press the **ANALOG** button on the Remote, you can switch to analog sound. To return to digital sound, press the **ANALOG** button again. With certain discs there may be a difference in volume.

Discs with a  (CX) Label



Discs bearing the  label are recorded with the CX noise reduction system, which gives lower noise levels and higher dynamic range on analog sound. The player detects most  discs and activates the CX noise reduction system automatically. Press the  button on the Remote. "CX ON" will appear on the TV screen for three seconds. When playing a  disc which does not contain a code to activate the CX noise reduction system, press the  button. "CX ON" will appear and the noise reduction system will be activated.

Understanding Displays and Messages When Playing LDs

You can determine player operating status or disc information in one of two ways: (1) by displaying the information on the TV screen, or (2) by looking at the front panel display. Locate the DISPLAY button on the Remote Commander.

To View On-Screen Information...



Press **DISPLAY** on the Remote. Each time you press DISPLAY, messages appear on the TV screen as shown below. The tables below are keys to the messages that appear on the right of the screen.

Press DISPLAY once.

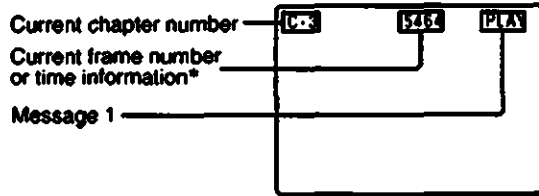

Press DISPLAY twice.

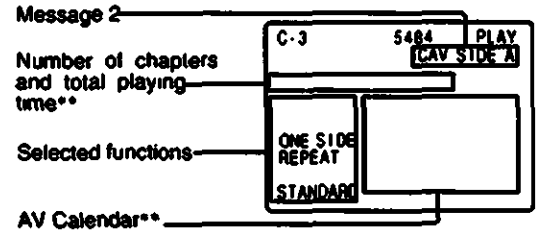

Message 1 (Examples)

Screen Display	Current Status of the Player
OPEN	Disc tray open
CLOSE	Disc tray closed
PLAY	Playing LD
STOP	Operation stopped
PAUSE	Operation momentarily stopped
Ⓢ / Ⓢ	Variable speed (Shuttle Ring) scan
SEARCH	Searching
▶ X 1/2	Scanning at 1/2-speed

Message 2 (Examples)

Screen Display	Currently Playing
CAV SIDE A	Standard-play disc side A
CAV SIDE B	Standard-play disc side B
CLV SIDE A	Extended-play disc side A
CLV SIDE B	Extended-play disc side B
1/L	First soundtrack/left channel
2/R	Second soundtrack/right channel
♪ DIGITAL	Digital sound
♪ ANALOG	Analog sound

To turn off the display, press DISPLAY again.

- * Discs not indicating time data to the second indicate instead as two-digit numbers such as, "22:".
- ** Appears when the QUICK START indicator is off (for an LD with TOC).

Reading the Front Panel Display

The illustration to the right is an example of what is displayed on the front panel of the player.

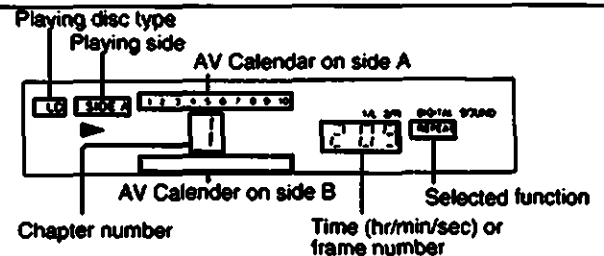

To View AV Calendar.....

When playing an LD containing TOC (Table of Contents) data, the AV Calendar is available. Press the QUICK START button on the player while in the stop mode to turn off the indicator beside the button, then press PLAY (▶). The AV Calendar on disc side A will be displayed. To view the AV Calendar on side B, press (DISC) SIDE B while the QUICK START indicator is off, the AV Calendar on disc side B will be displayed. The calendar shows information on the total number of selections on the disc or those programmed to play. As selections are played, the corresponding numbers in the AV Calendar disappear.

To Turn Off the Front Panel Display.....

Press FL DISPLAY on the player. Each time you press FL DISPLAY, the display turns on/off. When the front panel display is turned off, the blue TV screen during stop or search turns to gray.

How to Search Using Variable Speed Play (for CAV discs)

To find a scene, play the disc back or forward at varying speeds.* Use MULTI SPEED and SPEED SET for CAV standard-play LDs. Use the Shuttle Ring, which lets you scan gradually, for all discs. Locate the MULTI SPEED, SPEED SET, DISPLAY buttons and the Shuttle Ring on the Remote Commander.

To Change Speed and Direction (Multi Speed)

1 Press MULTI SPEED on the Remote to select the direction.



To reverse <
To advance >

2 Press SPEED SET on the Remote to select the speed.



To reduce speed -
To increase speed +
(You can press SPEED SET first, or do either step without the other.)

3 Press DISPLAY on the Remote.



The play speed and direction appear on screen.

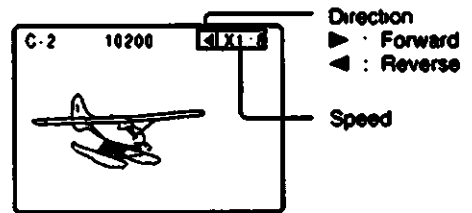

4 Press PLAY (▶).



Normal playback resumes.

Discs with Automatic Picture Stop Code

When an automatic picture stop code (found on educational discs) is encountered during X1 or less variable speed play, the unit automatically stops at that frame. To resume playback, press PLAY, MULTI SPEED, or turn the Shuttle Ring.

Extended-Play (CLV) or Non-CAV Discs

Variable Speed Play, Freeze Frame, and Step Play are not possible with CLV discs. When a MULTI SPEED button is pressed, the message "CLV SIDE A (or "B")" appears.

To Change Speed and Direction Gradually (Variable Speed Scan)**

Rotate the Shuttle Ring on the Remote in the forward or reverse direction.

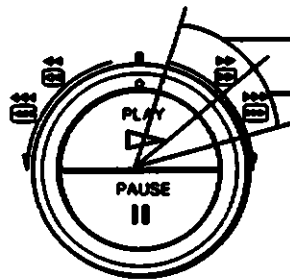

Scan at 10 times the normal speed

Scan at 30 times the normal speed

(Same speeds are available in the reverse direction.)

The play speed changes according to the degree you rotate the Shuttle Ring. The illustration indicates the approximate speeds.

By holding down SCAN (◀▶) on the player, you can scan scenes at a constant speed.

To Resume Normal Play

Release the Shuttle Ring or SCAN (◀▶) button.

* A certain amount of visual noise and instability is inevitable with all variable speed operations.

** Scanning speed varies as the laser beam moves away from the center of a CLV disc. The frames are skipped.

How to Search by Chapter Numbers

LDs are divided into sections called "chapters". Chapters are usually listed on the jacket or label of the disc. By entering the desired chapter number, you can have the player find the chapter and play it. Use ACS/AMS (◀◀▶▶) — Automatic Chapter Sensing/Automatic Music Sensing—to advance or reverse a chapter at a time. Locate the number keys and the ACS/AMS (◀◀▶▶) buttons on the Remote Commander.

To Locate a Particular Chapter (Chapter Search)

For example, to locate chapter 8, press "8" on the Remote.



Press one of the number keys on the Remote corresponding to the chapter you want to play.

The player starts searching for Chapter 8.

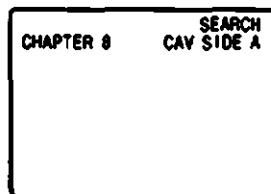

The player finds Chapter 8 and starts playing from the beginning of Chapter 8.

To Enter a Number Greater Than 10*

Do this to make a numerical sum. For example, to enter 14, press +10 and 4; to enter 30, press +10, +10, +10 and 0.



Press +10 and one of the number keys.



If you make a mistake while entering numbers, press +10 repeatedly until "CHAPTER 7-" disappears, then enter the correct numbers. The current chapter number appears in the front panel display.

To Check the Current Chapter Number



Press DISPLAY on the Remote to display the chapter number (upper left-hand corner) on screen. When the QUICK START indicator is off, you can also look at the AV Calendar (see page 17) for the chapters left to be played on the LD with TOC.

To Advance or Go Back a Chapter at a Time (Skip Search)



Press ACS/AMS (◀◀) once to return to the beginning of the current chapter.

Press ACS/AMS (▶▶) to advance to the beginning of the next chapter.

Press ACS/AMS (◀◀) twice before the picture reappears to return to the beginning of the previous chapter.

Press the ACS/AMS button repeatedly for continuous skip search.

To Resume Normal Play**

The player automatically resumes play from the beginning of the selected chapter.

* Chapter Search does not function properly if the disc does not contain chapter numbers, or the chapter number entered does not exist.

** In addition to normal play mode, you can conduct Chapter Search and Skip Search while in Freeze-Frame, Variable Speed Play, Repeat or Pause mode. When the specified chapter appears after the search, play continues in the same mode.

How to Search by Frame Number or Time—Frame/Time Search

Video scenes are counted as a series of still pictures or "frames". The player keeps track of the number of frames that have been played from the beginning of the disc to the current position. Similarly, the player also keeps track of the elapsed playing time from the beginning of the disc. To play from a particular frame or time, use the Frame/Time Search function. Locate the FRAME/TIME, SEARCH/NEXT buttons, and number keys on the Remote Commander.

On CAV (standard-play) discs, enter a frame number. On CLV (extended-play) discs, enter the time.*

To Enter the Elapsed Frame or Time

- 1 Press the FRAME/TIME button.

FRAME/TIME



The screen displays "00000" (for CAVs) or "0:00:00" (for CLVs).

CAV
(standard-play) disc

CLV
(extended-play) disc

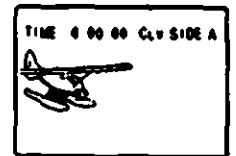

- 2 Enter the desired multi-digit number corresponding to the frame or time you want found.

Enter five digits for CAVs.
Enter four digits for CLVs displaying the time to the second.
Enter two digits for CLVs displaying the time to the minute.

Sample Entry for CAV Discs

To locate frame number 12340, press the number keys in the order on the right:



Sample Entry for CLV Discs

To locate the 12-minute, 5-second point, press the number keys in the order on the right:

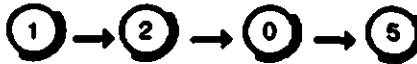

If you pressed the wrong key, press BACK to clear the number, then enter the correct number.

- 3 Press SEARCH/NEXT on the Remote

SEARCH/NEXT



Play starts from the time or frame specified in step 2.

To Check the Frame/Time Numbers

DISPLAY



The current frame or current time numbers appear on screen when you press DISPLAY. You can also find them on the front panel display.

To Cancel Frame/Time Search



Before pressing the SEARCH/NEXT button, press CLEAR. If you have already pressed the SEARCH/NEXT button, press STOP (■).

In addition to normal play mode, you can conduct Frame/Time Search while in Freeze-Frame, Variable Speed Play, Repeat or Pause mode. When the specified frame or time appears after the search, play continues in the same mode.

* "CAV" or "CLV" should be noted somewhere on the disc jacket.



How to Replay the Same LD Selections

These instructions show you how to program the player to play the same scenes over and over until you signal the repetition to stop. You can replay both sides, a single side, a single chapter or a section between one pair of points on the disc. Locate the REPEAT, 1/SIDE/ALL, and the REPEAT A↔B buttons on the Remote Commander.

To Repeat Both Sides of the Disc



Press REPEAT on the Remote. "REPEAT" lights up in the front panel display. When the player reaches the end of the disc side B, it returns to the beginning of the disc side A and starts playing again.

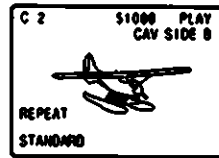

At the end of side B of the disc

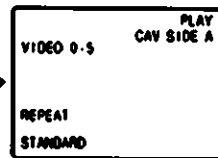

Returns to the beginning of the disc side A.

To Repeat the Current Side of the Disc (One Side Repeat)



Press 1/SIDE/ALL twice, then REPEAT on the Remote. "REPEAT" and "ONE SIDE" light up in the front panel display. When the player reaches the end of one side, it returns to the beginning and starts playing the side again.

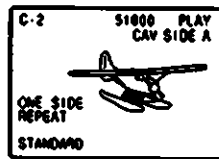

At the end of one side of the disc.

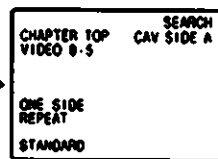

Returns to the beginning of the side.

To Repeat the Current Chapter (Single Repeat)

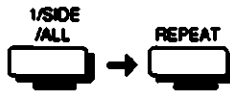

Press 1/SIDE/ALL once, then REPEAT on the Remote. "REPEAT" and "1" light up in the front panel display. The current chapter repeats continuously.

To Cancel Repeat Play



Press REPEAT.

To Cancel One Side Repeat



Press 1/SIDE/ALL once, then REPEAT.*

To Cancel Single Repeat



Press 1/SIDE/ALL twice, then REPEAT.*

* You can also cancel Repeat, One Side Repeat and Single Repeat by pressing CLEAR.

To Repeat One Section of the Disc

- 1 Go back to the start of the scene you want replayed. This marks where replay is to begin.
- 2 Press REPEAT A↔B on the Remote at the beginning of where you want replay to begin. The "REPEAT" and "A-" indication lights up, and "B" indication in the front panel display flashes.
- 3 Let the player run to the end of the scene you want repeated.
- 4 Press REPEAT A↔B again. This marks where replay is to end.

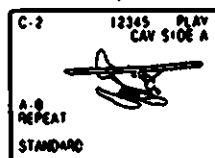
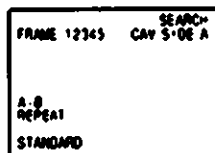

"REPEAT" and "A-B" light up in the front panel display. The player repeatedly plays the same scene between the two points selected.

To Cancel REPEAT A↔B

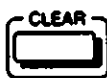

Press CLEAR.

To Return to a Specific Point (Memory Search)

- 1 Go back to the point you want to replay.
- 2 Press REPEAT A↔B on the Remote to mark the point.
- 3 Press CLEAR to turn off the indication "A-B REPEAT".
- 4 Press SEARCH/NEXT on the Remote at any point you like on the disc.

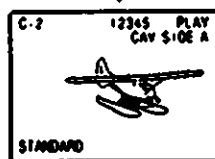
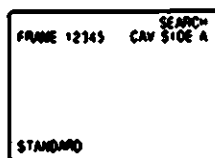
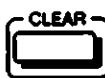

The player returns to the point you marked and starts playing.*

* The point marked "A" from where you can resume playback is stored in the player's memory until you open the disc tray or turn off the player. "A" is also cleared if you carry out a Frame/Time Search.

How to Play Only Certain Chapters—Programmed Play

You can choose, in any order you like, the chapters the Multi Disc Player plays. This play list is stored in the player until you either remove the disc or turn off the power. After playing all the selections, the player stops and waits for your next command. You can program up to 25 chapters for sides A and B combined. Locate the number keys, DISC SIDE A/B, PGM and PLAY buttons on the Remote Commander.

For example, you want to play chapters 1, 2, 3 on side A, chapter 10 on side B, then stop playing momentarily. Continuing with chapter 4 on side B, then back to side A to play 7 (in that order).

1 Press PGM.

"PROGRAM --:--" appears on screen.
"PGM" flashes in the front panel display.

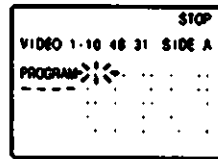

2 Press 1, 2 and 3.

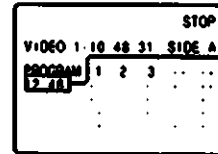

Total playing time* (See the section below, "To Check the Total Playing Time".)

3 Press DISC SIDE B, then +10, 0, PAUSE (II).

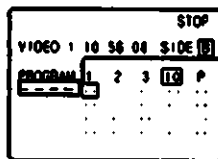

When you enter PAUSE (II), the display returns to "--:--" "P" indicates that a PAUSE (II) is entered.

4 Press 4, DISC SIDE A, then, 7.

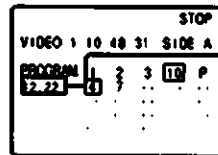

The total playing time of the programmed chapters entered after the PAUSE (II).

5 Press PLAY (▶).



To Check the Total Playing Time

You can check the total playing time of the programmed chapters on the LD containing TOC (Table of Contents) data. To display the total playing time of the programmed chapters, press the QUICK START button while in the stop mode to turn off the indicator, then press PLAY (▶) to display the AV Calendar before you press the PGM button. When you program chapters on side B while checking the total playing time, press (DISC) SIDE B to display the AV Calendar on side B before pressing the PGM button.

* If you enter 0 or chapter numbers 51 or greater, or if total playing time exceeds 100 minutes, the total playing time turns to "--:--".

To Start Over



Press **CLEAR**, then **PGM**. Enter the new chapter numbers.

To Change an Entry

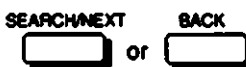

Press **SEARCH/NEXT** or **BACK** to advance or go back one entry. Enter the correct number.

To Enter a Number Greater Than 10

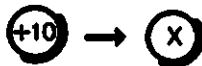

Press **+10** and one of the number keys, following the same procedure as on page 19.

To Cancel Programmed Play ...

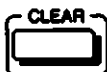

Press **CLEAR**.
The player resumes normal playback.

To Replay the Programmed Chapters



Press **REPEAT**.
"REPEAT" is displayed on the screen.

To Advance or Go Back a Chapter*



Press **ACS/AMS** (◀◀ or ▶▶).

To Check the Contents of the Program



Press **DISPLAY** twice.
The flashing number indicates the chapter now playing.

* The player does not go back to previous chapters if the Shuttle Ring is rotated to the left, although, it does advance to forward chapters if rotated to the right. To go back to preceding chapters press the ACS/AMS (◀◀) button.

How to Play Frame-by-Frame (for CAV discs)

Once you have found a particular scene, you can examine the progression of that scene by advancing or reversing the action one frame at a time (Step Play),* or freezing the action into a still picture (Freeze Frame).* Locate the PAUSE, and STILL/STEP buttons on the Remote Commander.

To Play One Frame at a Time (Step Play)

- 1 Press PAUSE (II) once.



The frame freezes.

- 2 Press STILL/STEP on the Remote repeatedly.
Hold down the button for continuous frame-by-frame action.



Each press shifts the image one frame backward or forward.

To reverse ◀
To advance ▶

In addition to pause mode, you can achieve Step Play while the player is in play mode by pressing one of the STILL/STEP buttons while the disc is playing.

To Freeze the Action (Freeze Frame)



Press PAUSE (II) once.

To Resume Normal Play.....



Press PLAY (▶).

Extended-Play (CLV) Discs.....

Freeze Frame and Step Play are not possible with CLV discs. When the PAUSE button is pressed, the screen goes blank and the message "CLV SIDE A (or B)" appears.

How to Continue Play from the Point You Stopped at — Memory Play —

This function can only be used for LDs, and in the continuous play mode. Even if you use the STOP (■) button to stop, you can still continue play from the point you stopped at. Locate the MEMORY PLAY button on the Remote Commander.

To Play Again from the Point You Stopped at.....



Press MEMORY PLAY while in the stop mode.

The player starts searching for the point you stopped at.

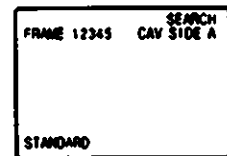

Play starts from the point you stopped at.

The point at which you stopped playing is stored in the player's memory until you press STOP (■) next. It is retained even if you turn off the power.** Press MEMORY PLAY. The player turns on and resumes playback from the point you stopped at.

* This function can only be performed on CAV discs.

** If you press ▲, the memory is cleared and this function is canceled.

To Play a Compact Disc

This section explains how to perform procedures associated with playing CDs.

How to Load and Play a CD (Compact Disc)

After you have connected the Multi Disc Player to the stereo system, you can begin playing a compact disc. Locate the POWER, OPEN/CLOSE and PLAY buttons on the Remote Commander or the front panel of the player.

1 Turn on the multi disc player.



(Player)



(Remote)

Press the POWER button on the player or Remote Commander.

2 Turn on the stereo system.

Turn on the amplifier or receiver and select CD, AUX or other desired audio input.

3 Open the disc tray.



(Player)



(Remote)

Press the OPEN/CLOSE (\triangle) button. The front cover of the player slides down and the disc tray comes out.

4 Place a disc on the tray.

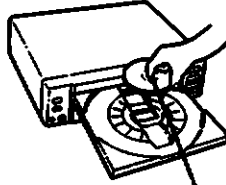

Label faces up.

Carefully center a single CD on the tray. * If you insert more than one disc, or the disc is not seated properly, it may not play or damage the unit.

What is this indication?

NO DISC

This indication appears in the front panel display when the tray is empty.

5 Start playback.



(Player)



(Remote)

Press PLAY (\triangleright).**

To Advance or Reverse



(Player)



(Remote)

Hold down the SCAN (\lll/\ggg) button on the player or rotate the Shuttle Ring on the Remote.

To Advance or Go Back One Track at a Time



(Player or Remote)

ACS/AMS

Press the ACS/AMS (\lll/\ggg) button.

To Interrupt Play



(Player)



(Remote)

Press PAUSE (\parallel).

To resume playback, press PAUSE (\parallel) or PLAY (\triangleright).

* Do not use a CD stabilizer as it may cause damage to your disc or player.

** You can start playing by pressing (DISC) SIDE A instead of PLAY (\triangleright). If you press (DISC) SIDE B, the player stops.

To Stop Playback



Press STOP (■).
To play again from the beginning, press PLAY (▶).

To Stop Play and Remove the Disc

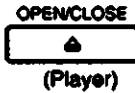

Press OPEN/CLOSE (⏏). Remove the CD and press ⏏ again to close the empty tray.

To Have the Player Pause Before Starting



Press PAUSE (⏏) after doing step 4 on page 26.
The tray closes and the player waits at the start of the disc until you press PLAY (▶) or PAUSE (⏏)

To Play a Stereo CD or a Second Audio Program (SAP) CD

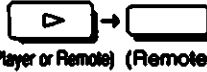

Press PLAY (▶), then press the AUDIO MONITOR button on the Remote.

The procedure below indicates how the output and the display change with each press. The active tracks appears for three seconds on the TV screen. It always appears in the front panel display.

Procedure	Screen message	Output Sound	
		Stereo Disc	SAP Disc
1 Press PLAY (▶).	No message	Stereo (Both channels)	Soundtrack 1 (left channel) Soundtrack 2 (right channel)
2 Press AUDIO MONITOR.	1/L	Left channel	Soundtrack 1 (left channel)
3 Press AUDIO MONITOR again.	2/R	Right channel	Soundtrack 2 (right channel)
4 Press AUDIO MONITOR again to return to stereo status.	1/L 2/R	Stereo (Both channel)	Soundtrack 1 (left channel) Soundtrack 2 (right channel)

Understanding Displays and Messages When Playing CDs

You can determine player operating status or disc information in one of two ways: (1) by displaying the information on the TV screen, or (2) by looking at the front panel display. Locate the DISPLAY button on the Remote Commander.

To View On-Screen Information



Turn on the television, and press DISPLAY on the Remote.
 Each time you press DISPLAY, messages appear on the TV screen as shown below. The table is a key to the messages that appear on the right of the screen.

Press DISPLAY once.

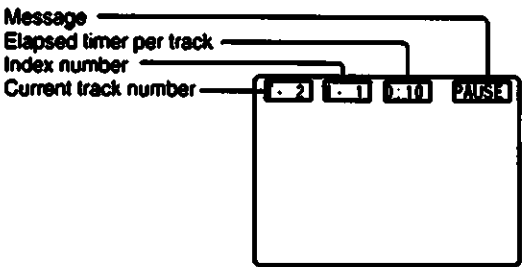

Press DISPLAY twice.

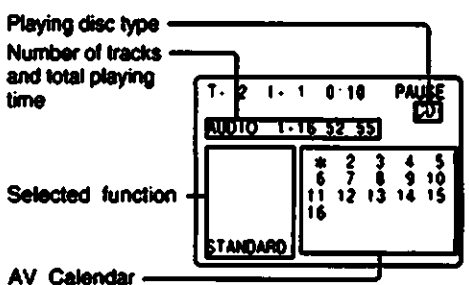

Message (Examples)

Screen Display	Current Status of the Player
OPEN	Disc tray open
CLOSE	Disc tray closed
PLAY	Playing CD
STOP	Operation stopped
PAUSE	Operation momentarily stopped
Ⓢ / Ⓢ	Variable Speed (Shuttle Ring) Scanning
SEARCH	Searching

To turn off the display, press DISPLAY again.

Reading the Front Panel Display

The illustration to the right is an example of what is displayed on the front panel of the player.

Finding Out Play Status

When playing a CD, the AV Calendar shows information on the total number of tracks on the disc or those programmed to play. As tracks are played, the corresponding numbers in the calendar disappear. If the CD contains more than 20 tracks, ">" appears to the right of the calendar.

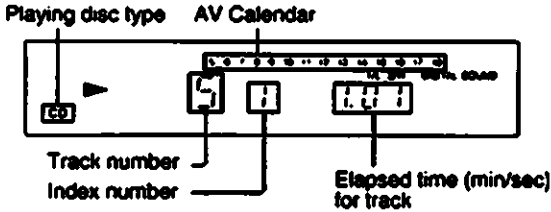

To Turn Off the Front Panel Display

Press FL DISPLAY on the player. Each time you press FL DISPLAY, the display turns on/off.

How to Locate a Certain Track

CDs are divided into sections called "tracks". To scan a disc and find a certain point regardless of tracks, use the Shuttle Ring. To find and play from the beginning of a certain track, use the number keys. In addition, use the ACS/AMS (◀◀/▶▶) buttons to advance or reverse one track at a time. Locate the number keys, Shuttle Ring, and ACS/AMS (◀◀/▶▶) buttons on the Remote Commander.

To Find a Certain Point on the Disc

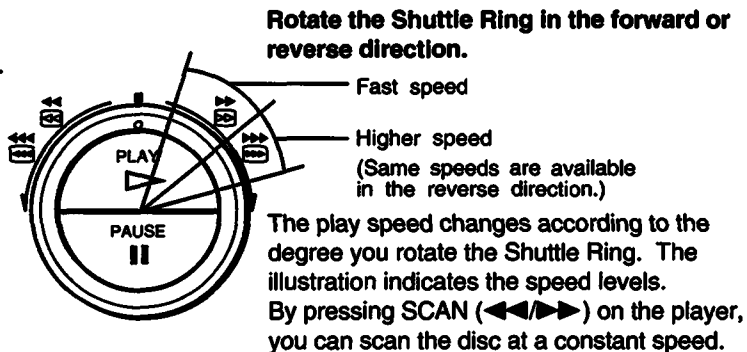

To Locate a Particular Track (Track Search)



Press one of the number keys on the Remote to enter the track number you want played.

To Enter a Number Greater Than 10



Press +10 and one of the number keys.

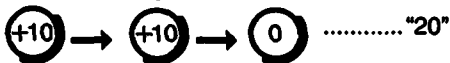

Do this to make a numerical sum. For example, to enter 18, press +10 and 8; to enter 20, press +10, +10 and 0.

If you make a mistake while entering a number, press +10 repeatedly until "9-" disappears, then enter the correct number.

To Check the Current Track Number

See the AV Calendar on the front panel display.

To Advance or Go Back One Track at a Time (Skip Search)



Press ACS/AMS (◀◀) once to return to the beginning of the current track. Press it again before the selection starts to return to the beginning of the previous track.

Press ACS/AMS (▶▶) to advance to the beginning of the next track.

Press the ACS/AMS button repeatedly for continuous skip search.

To Play a Single Track Once

1 Press the 1/SIDE/ALL button on the Remote.



"1" is displayed.

2 Enter the track number you want played.



When the track has been played, the player stops. To cancel the setting, press 1/SIDE/ALL again or CLEAR.

If you press the wrong number keys, simply press the correct ones.

How to Search by Elapsed Playing Time—Time Search

You can locate a particular point on a CD by specifying the elapsed playing time from the beginning of the disc. Locate the FRAME/TIME, SEARCH/NEXT and number keys on the Remote Commander.

To Enter the Elapsed Playing Time

1 Press the FRAME/TIME button.



"00.00" appears in the front panel display.

2 Enter the desired multi-digit number corresponding to the time you want found.*

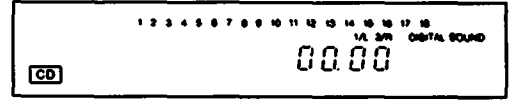

Enter four digits.

Sample Entry for CDs
To locate the 12-minute, 5-second point, press the number keys in the order on the right:

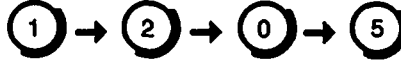

If you press the wrong key, press BACK to clear the number, then enter the correct number.

3 Press SEARCH/NEXT on the Remote.



Play starts from the time specified in step 2.

To Cancel Time Search

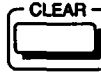

or



Before pressing the SEARCH/NEXT button, press CLEAR. If you have already pressed the SEARCH/NEXT button, press STOP (■).

In addition to normal play mode, you can conduct Time Search while in Repeat or Pause mode. When the specified time appears after the search, play continues in the same mode.

* If you enter a time number not contained on the disc, play stops.

How to Replay the Same CD Selections

You can program the player to play the same selections over and over until you signal the repetition to stop. You can replay the entire disc, a single track, or a section between one pair of points on the disc.

Locate the REPEAT, 1/SIDE/ALL, and the REPEAT A↔B buttons on the Remote Commander.

To Repeat the Entire Disc



Press REPEAT on the Remote.

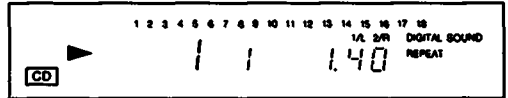

"REPEAT" lights up in the front panel display. The player plays all tracks on the CD. When the player reaches the end of the disc, it plays again.

To Repeat the Current Track (Single Repeat)

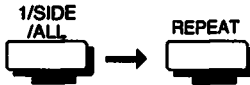

Press 1/SIDE/ALL, then REPEAT on the Remote.

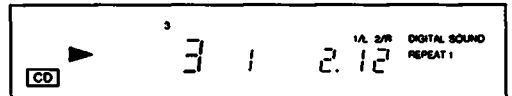

"REPEAT" and "1" light up in the front panel display. The current track repeats continuously.

To Cancel Repeat Play



Press REPEAT. "REPEAT" disappears.*

To Cancel Single Repeat

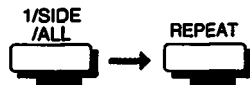

Press 1/SIDE/ALL and REPEAT.*

To Repeat One Section of the Disc

- 1 Go back to the start of the section you want replayed.
- 2 Press REPEAT A↔B on the Remote to mark the beginning of the section.
- 3 Let the player run to the end of the section you want repeated.
- 4 Press REPEAT A↔B again to mark the end of the section.



The "REPEAT" and "A-" indication lights up, and "B" indication begins flashing in the front panel display.

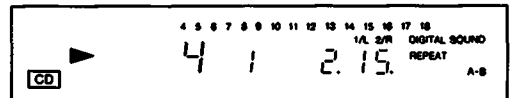

"REPEAT" and "A-B" light up in the front panel display. The player repeatedly plays the selection between the two selected points.

To Cancel REPEAT A↔B

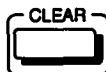

Press CLEAR.

* You can also cancel Repeat and Single Repeat by pressing CLEAR.

How to Play Only Certain Tracks—Programmed Play

You can program, in any order you like, the tracks the Multi Disc Player plays. This play list is stored in the player until you either remove the disc or turn off the power. Program up to 25 tracks. After playing all the selections, the player stops and waits for your next command. Locate the number keys, PGM, and PLAY buttons on the Remote Commander.

1 Press PGM.



"PGM" flashes in the front panel display.

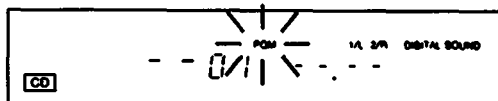

2 Press one of the number keys.



Press numbers for all the tracks you want played. For example, press 5, 4, 6 and 2 to play those tracks.

The total playing time of the programmed tracks is displayed on the front panel display.

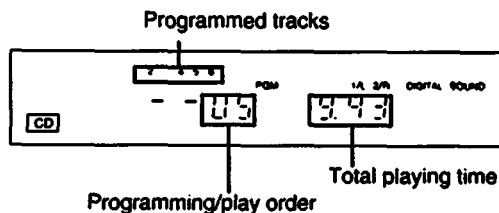

3 Press PLAY (▶).



To Start Over



Press CLEAR and PGM. Then, enter the correct track numbers.

To Change an Entry

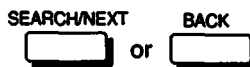

Press SEARCH/NEXT or BACK to advance or go back one entry. Enter the new number.

To Enter a Number Greater Than 10



Press +10 and one of the number keys following the same procedure as on page 29.

To Program a Pause



Press PAUSE at the point you want the program to stop playing. A PAUSE is counted as a selection.

To Cancel Programmed Play ...

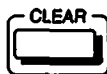

Press CLEAR. The player resumes normal playback.

To Replay the Same Programmed Tracks



Press REPEAT on the Remote. "REPEAT" is displayed in the front panel display.

To Advance or Go Back a Track*



Press ACS/AMS (◀◀ or ▶▶). The player moves to the preceding or following programmed tracks.

To Check the Contents of the Program (TV screen)



Press DISPLAY twice. The programmed track numbers are displayed on the TV screen. The flashing number indicates the current track. Once the track has been played, the track number in the front panel display (AV Calendar) disappears.

* The player does not go back to previous tracks if the Shuttle Ring is rotated to the left, although, it does advance to forward tracks if rotated to the right. To go back to preceding tracks, press the ACS/AMS (◀◀) button repeatedly.

To Play a Compact Disc Video

This section explains basic procedures for playing CDVs and VSDs. Since CDV and VSD play holds so many functions in common with CD and LD play, see other sections of this manual for details of applicable functions mentioned here.

How to Load and Play a CDV (Compact Disc Video) or VSD (Video Single Disc)

CDVs are divided into two sections: video and audio. The video section of the disc consists of 5 minutes of video play with digital audio output. The audio section consists of 20 minutes of solely digital audio output (playable on any CD player). Thus, the CDV has the function of both an LD and CD combined in one disc. The audio and the video sections of the CDV are assigned track numbers. The track on the video section tracks corresponds to the chapter on the LD and the same on the CD. You can regard VSDs as CDVs that have no audio tracks.

1 Turn on the TV, stereo system (if connected), and Multi Disc Player.

2 Place the disc on the tray.

3 Press PLAY (▶).

Play begins from the video section.

To start play from the audio section, using the number keys, enter the track number that starts the audio section.

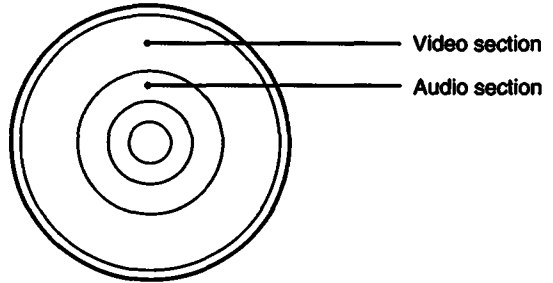

To Stop and Remove the Disc

OPEN/CLOSE



To Advance or Go Back a Track at a Time

ACS/AMS



To Interrupt Play



To Find a Certain Audio or Video Track



To Play Certain Video Tracks



To Repeat the Current Track



To Repeat All Selections



To Repeat a Section of the Disc



To Variable Speed Scan (Audio and Video)

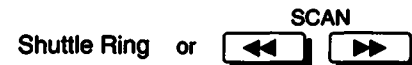

Understanding Displays and Messages When Playing CDVs or VSDs

You can determine player operating status or CDV information in one of two ways: (1) by displaying the information on the TV screen, or (2) by looking at the front panel display. Locate the DISPLAY and AV TIME buttons on the Remote Commander.

To View On-Screen Information . . .



Press DISPLAY on the Remote.
Each time you press DISPLAY, messages appear on the TV screen as shown below. The table is a key to the messages that appear on the right of the screen.

Press DISPLAY once.

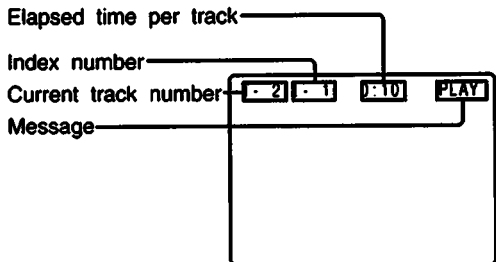

Press DISPLAY twice.

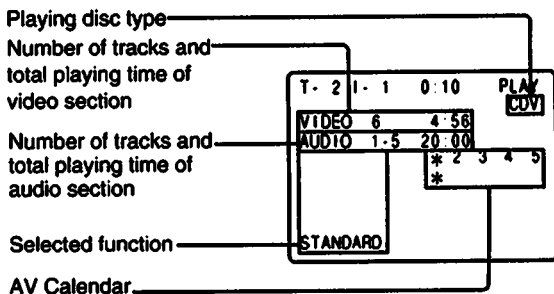

Message (Examples)

Screen Display	Current Status of the Player
OPEN	Disc tray open
CLOSE	Disc tray closed
PLAY	Playing CD
STOP	Operation stopped
PAUSE	Operation momentarily stopped
⏮ / ⏭	Variable Speed (Shuttle Ring) Scanning
SEARCH	Searching

To turn off the display, press DISPLAY again.

To Display Remaining Playback Time



Press AV TIME. See "How to Display the Elapsed Playing Time – Time Counter" on page 36.
Example. Press AV TIME three times.

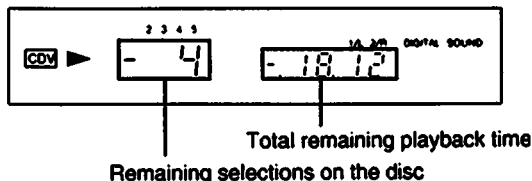

Finding Out Play Status

When playing a CDV, the AV Calendar on the front panel display shows information on the total number of selections. As selections are played, the corresponding numbers in the calendar disappear.

To Turn Off the Front Panel Display

Press FL DISPLAY on the player. Each time you press FL DISPLAY, the display turns on/off.

To Play Any Disc (Advanced Functions for LD, CD, or CDV Play)

This section explains advanced functions which apply to any one of the three types of discs.

How to Have the Disc Play Within a Set Period of Time

You can program the disc to play within a specified period of time. This is called "Auto Program Playback." Decide how long you want the disc to play and then enter half that amount of time. The player divides the selections on the disc into what it calls "Program A" and "Program B," playing both A and B for the amount of time entered. The player pauses between the two programs. The following procedure explains how to conduct Auto Program Playback on a CD, but you can also use the function for LDs with TOC and CDVs. (Auto Program does not function on LDs that do not contain TOC data.) Locate the AUTO PGM button and number keys on the Remote Commander.

To Ensure Correct Operation

When you play an LD with TOC, press the QUICK START button on the player while in the stop mode to turn off the indicator, then press PLAY (▶) to display the AV calendar before you press the AUTO PGM button. When you operate Auto Program on side B of the LD in the player, press (DISC) SIDE B to display the AV Calendar on side B before you press the AUTO PGM button.

To Play Selections Using Auto Program

- 1 Press AUTO PGM on the Remote.

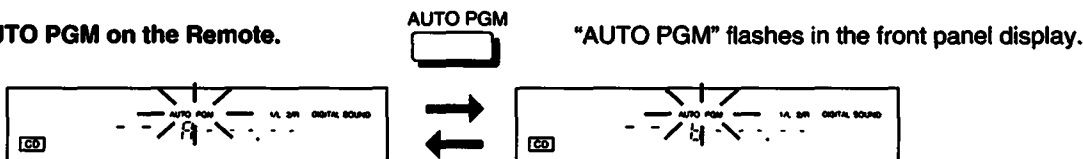

- 2 Enter the desired play time.
Using the number keys, enter the time.
For example, to enter 30 minutes, press +10 three times and 0.*

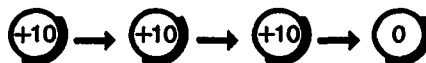

If you press the wrong number, simply press the correct one.

Program A and Program B appear alternately in the AV Calendar displays the contents of the two different programs: Program A and B, separated by a pause.

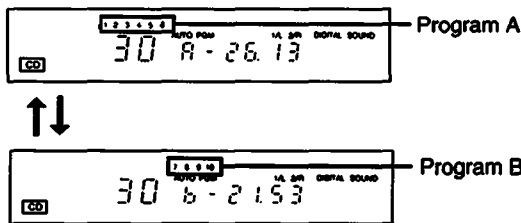

If you designate a play time shorter than half the length of the disc, some selections on the disc may not fit into the time span given and therefore may not play. On the other hand, if you designate a play time longer than the length of the disc, the whole program of selections may run on Program A, with none running on Program B. This is because Program A always has priority over B.

Example for a Forty-Minute Disc

Let's say your disc is 40 minutes long (see table below) and you designate playing time to run 15 minutes. Program A will run for 15 minutes (or less) and Program B will also run for 15 minutes (or less) for a total of about 30 minutes of play (see table below).

You enter	Program A plays	Program B plays	Total play time
15	15 min (or less)	15 min (or less)	30 min (or less)
30	30 min (or less)	10 min (about)	40 min
45	40 min (all selections)	0 min	40 min

- 3 Press PLAY (▶).



Program A selections start playing. The player pauses at the end of Program A and waits for you to press PLAY (▶) again for Program B.

- 4 Press PLAY (▶) again to play Program B.



To Resume Normal Play from Auto Program

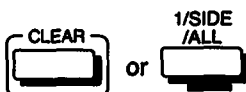

Press CLEAR or 1/SIDE/ALL.

* If your LD contains 51 or more chapters on the playing side, Auto Program may not operate correctly.

How to Display the Elapsed Playing Time — Time Counter

You can display elapsed time information on the front panel display or TV screen. How the information is displayed depends on the type of disc being played. When playing an LD, press QUICK START while in the stop mode to turn off the indicator beside the button. When the indicator is lit, remaining time is not displayed. Locate the AV TIME button on the Remote Commander.

To View the Elapsed or Remaining Time



Each time you press AV TIME, The front panel display changes as follows.

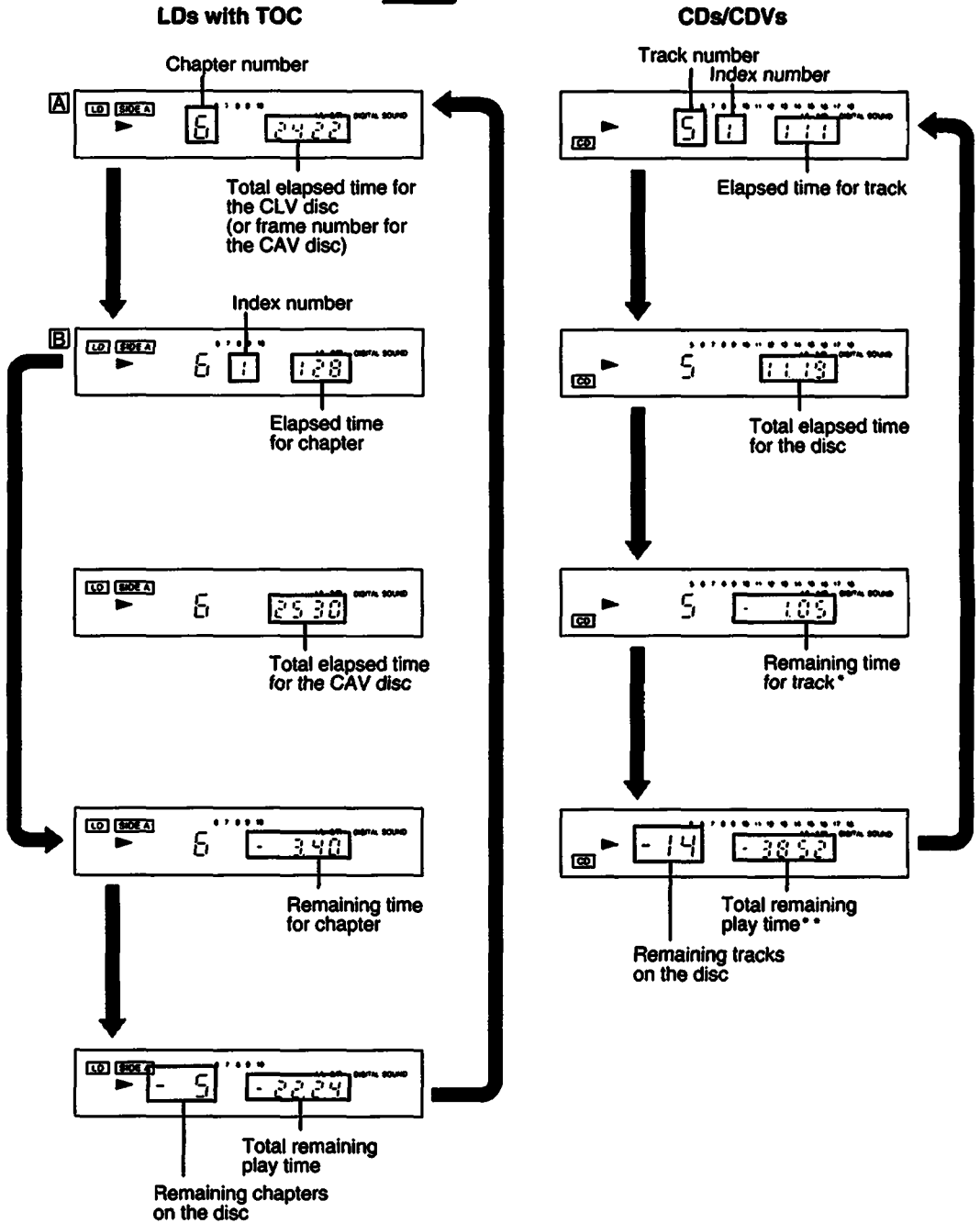

When the QUICK START indicator is lit (or the LD does not contain TOC), you can only change the display between **A** and **B**.

* The display does not show remaining play time for chapters on an LD numbered 51 or greater.

** When playing CDVs, these figures refer only to the current section (audio or video) being played.

How to Program the Player to Pause or Scan Automatically

There are many functions you can program the Multi Disc Player to do automatically. Two of them are Auto Pause and Intro Scan. To make the player stop every time a selection ends, use Auto Pause. When you want to find a particular track, use the INTRO button to make the player play the first 8 seconds (approximately) of each chapter or track on the CD, LD, or CDV. Locate the AUTO PAUSE and INTRO buttons on the Remote Commander.

To Make the Player Stop Momentarily (Auto Pause)

AUTO PAUSE



Press AUTO PAUSE on the Remote.

When the current selection ends, the player pauses.

To play the next selection, press PLAY (▶).*

To display "A. PAUSE" on the TV screen, press DISPLAY twice. If you have pressed DISPLAY once, "A. PAUSE" appears for three seconds, then disappears.

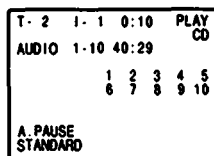

To Resume Normal Playback

AUTO PAUSE



Press AUTO PAUSE again.

To Scan the Beginning of Each Chapter/Track (Intro Scan)

INTRO



Press INTRO on the Remote.

The player plays only the first 8 seconds (introduction) of each chapter or track on the disc.** When playing an LD, the player pauses after introducing the last chapter on side B of the disc. If nothing is recorded on side B, the player stops at the end of side A. On CDVs, intro-scanning resumes from the video section of the disc.

To Resume Normal Play

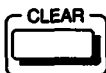

Press CLEAR.

Play resumes from the selection just introduced.

To Stop Play



Press STOP (■).

* In Single Repeat mode, the same selection starts playing again. In Repeat A-B mode, playback starts from the point marked "A".

** In stop mode, intro-scanning starts from the first chapter or track on the disc. If you press INTRO while playing a chapter or track, scanning starts from the next one. If you press INTRO while the player is introducing a chapter or track, the scanning skips to the next one.

How to Play Selections in Random Order—Shuffle Play

Shuffle Play is another of the Multi Disc Player's programmable functions. As the name implies, this function allows you to play all the tracks or chapters on a disc in random order once or repeatedly. From this random order you may program the player to delete tracks or chapters you don't want played. (Note that Shuffle Play can only be conducted on LDs containing TOC data, CDs and CDVs.) Locate the number keys, SHUFFLE, and PLAY buttons on the Remote Commander.

Before Shuffle Play on an LD With TOC

You can shuffle play on an LD only when the AV Calendar on the playing side is displayed. Make sure that the AV Calendar(s) on the playing side(s) are displayed before shuffle playing.

- 1 Press the **QUICK START** button on the player while in the stop mode.

QUICK START



The QUICK START indicator goes off.

- 2 Press **(DISC) SIDE A** to display the AV Calendar on side A.



- 3 Press **(DISC) SIDE B** to display the AV Calendar on side B.



- 4 Press **STOP** (■).

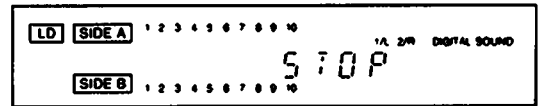

The AV Calendars on side A and B appear.

To Shuffle Play All Chapters on Both Sides of an LD (Both Sides Shuffle)

- 1 Make sure that the AV Calendars on both sides of the LD are displayed.

- 2 Press **SHUFFLE** on the Remote.

SHUFFLE



- 3 Press **1/SIDE/ALL** to turn off "1 SIDE".

1/SIDE
/ALL



- 4 Press **PLAY** (▶).



All the chapters on both sides of the LD are played once in random order. After all the chapters are played, the player stops.

To Shuffle Play All Chapters on One Side of an LD (One Side Shuffle)

- 1 Make sure that the AV Calendar on the disc side you want to play is displayed.

- 2 Press **(DISC) SIDE A or B** to select the playing side.

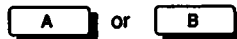

- 3 Press **SHUFFLE** on the Remote.

SHUFFLE



- 4 Press **PLAY** (▶).



All the chapters on the side selected in step 2 are played once in random order. After the chapters are played, the player stops.

To Shuffle Play all Tracks on a CD or CDV

When you play a CD or CDV, make sure the disc tray has closed completely, and the "STOP" indication in the front panel display has stopped flashing, then press the SHUFFLE button.

- 1 Press SHUFFLE.



"SHUFFLE" flashes in the front panel display.

- 2 Press PLAY (▶).

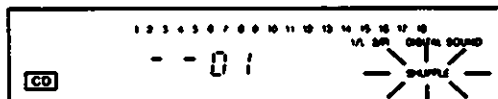

All the selections on the disc play once in random order. After all the selections play, the player stops. CDV selections play randomly from both the audio and video parts of the disc.

To Advance to the Next Selection



Press the ACS/AMS (▶▶) button to skip to the next track or chapter. (The ACS/AMS (◀◀) button does not function to return to a previous track or chapter in Shuffle Play mode.) Or, use the Shuttle Ring.

To Resume Normal Play

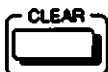

Press CLEAR or 1/SIDE/ALL. This clears Shuffle Play. Playback resumes from the next selection.

To Delete Certain Selections from Shuffle Play (Delete Shuffle)

- 1 Press SHUFFLE.



- 2 Enter the chapter or track number of the selection you do not want the player to play.

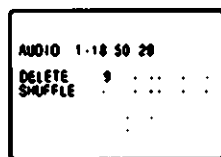

(TV Screen)

- 3 Press PLAY (▶).



The player automatically plays a random program of selections without the ones you deleted.

To Clear an Entry

- 1 Press CLEAR.

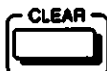

- 2 Press SHUFFLE.



- 3 Enter the correct numbers.*

To clear the entry during play, press CLEAR and SHUFFLE again before entering the correct numbers.

To Change an Entered Number

- 1 Press SEARCH/NEXT (to advance) or BACK (to go back) until the number you want to change flashes on the front panel display.



- 2 Using the number buttons, enter the correct number.



* When shuffle playing on an LD, you can delete chapters from each side of the LD. Press one of the DISC SIDE A/B buttons corresponding to the disc side on which you want to delete chapters, then enter the chapter number. The chapter numbers on side B are displayed in squares.

Repeat Shuffle Play



Press the REPEAT button on the Remote. This activates the REPEAT indication in the front panel display. The player reshuffles the selections and plays them back in a different random order.

Clear Shuffle Play



Press CLEAR or 1/SIDE/ALL. When you turn off the player, or you remove the disc, all shuffle functions clear from the memory of the player.

To Play Karaoke

1 Connect the microphone

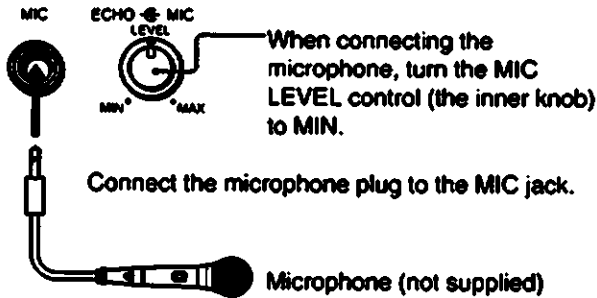

2 Turn on the player

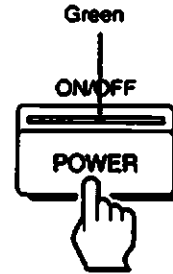

Extra Functions for Karaoke Entertainment

Using the AUDIO MONITOR and ANALOG buttons (page 16)

Karaoke discs can be recorded using one of three formats: multi audio (**MULTIAUDIO**), multiplex and stereo. Multi audio and multiplex discs include vocals. Stereo discs do not. If the disc loaded in the player is a multi audio or multiplex disc, you can play Karaoke listening to the voice recorded on the disc by alternating the sound using the AUDIO MONITOR or ANALOG button on the Remote Commander.

Auto Pause (page 37)

You can make the player pause every time a selection ends. To play the next selection, press PLAY (▶) or PAUSE (⏸), or choose the selection directly with the number key(s).

Programmed Play (page 23)

You can choose the selections in any order you like and play them continuously for non-stop Karaoke entertainment.

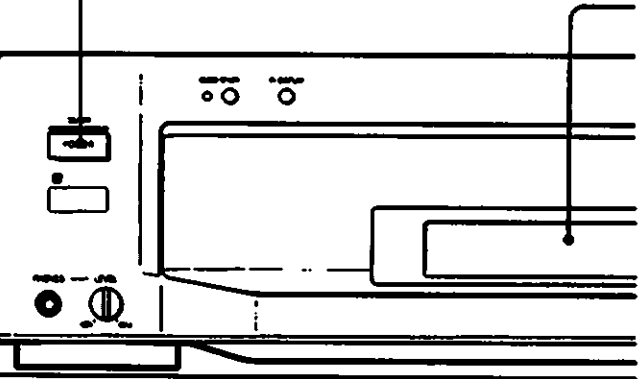

8 Adjust the microphone echo



Adjust the strength of the echo with the ECHO LEVEL control (the outer knob).

If howling occurs

Correct by doing the following:

- Move the microphone away from the speakers
- Lower the MIC or ECHO LEVEL
- Lower the volume of the speakers

When listening through headphones

Once the headphones are connected, the volume must be adjusted with the LEVEL control beside the PHONES jack.

Note about disc sides

The player determines that the upper side of the disc is side "A," and the other side is "B," regardless of label "A" or "B" printed on the disc.

3 Turn on the TV and stereo system

TV: Set to "Video".

Stereo system:

Turn on the amplifier or receiver and select CD or AUX for audio output.

4 Open the disc tray

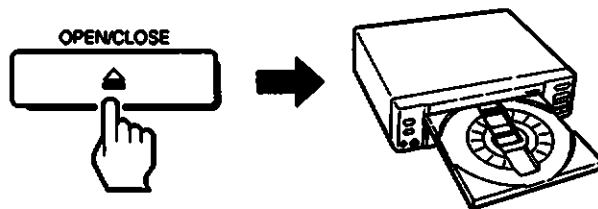

5 Place a disc on the tray

Carefully center a single disc on the tray. The disc will not play if it is not seated properly.



Always insert one disc at a time. Inserting more than one may damage the player.

7 Adjust the microphone volume



Adjust the microphone volume with the MIC LEVEL control (the inner knob).

Sound from a microphone cannot be output when the player is connected to the amplifier with a Fiber Optical Cable. To output sound from a microphone, use an Audio Cable (Red & White plugs) for connection.

6 Choose a selection to play



• The disc tray closes automatically and play starts.

- Press PLAY (▶) or push the disc tray to playback from the beginning of the disc (side A of the LD).
- To choose a selection on side B of the LD, press DISC SIDE B, then press the number key(s).

If the output is distorted

The output may sound distorted when listening through your TV speakers. Correct this by setting the ATT (Attenuator) switch on the rear panel of the player to ON. (This will lower the volume which should now be adjusted with the volume control on the TV.

If the picture on the TV flickers

The picture appearing on the TV screen may flicker when listening through your TV speakers and the MIC volume is set too high. Correct this by setting the ATT (Attenuator) switch on the rear panel to ON, or lower the MIC LEVEL.

Additional Information

This section contains information that will help you if you have problems with your player. It also contains maintenance information and glossary.

Troubleshooting

Check the following before requesting service.

Symptom	Point to check
No power	<ul style="list-style-type: none">• AC Power cable properly connected?
PLAY (▶) button or Number keys do not produce playback.	<ul style="list-style-type: none">• Disc inserted?• Disc properly seated?• Recorded side facing upward?
▶ indicator is lit, but there is no picture or sound.	<ul style="list-style-type: none">• TV or monitor switched on?• TV properly connected to player?• The input selector on TV set to "Video"?
Poor picture or sound quality	<ul style="list-style-type: none">• TV properly connected?• Any source of noise nearby?• Disc dirty or scratched?• Any condensation on player objective lens?
No sound	<ul style="list-style-type: none">• TV properly connected to player?• Volume control on TV, monitor, or amplifier high enough?• Playback at normal speed? (The player produces sound only during normal speed playback.)
Remote Commander does not operate.	<ul style="list-style-type: none">• Batteries correctly inserted?• Batteries weak?• Any obstacles between the Remote Commander and the Sensor on the player?• The Remote Commander is pointed at the sensor on the player?
Picture distorted during scan.	<ul style="list-style-type: none">• Some distortion in the lower part of the picture is normal – even for CAV discs.
No sound from microphone	<ul style="list-style-type: none">• MIC LEVEL control is MIN?• Microphone switch is ON?• Connecting to amplifier with a Fiber Optical Cable?
Shuffle, Delete Shuffle or Auto Program does not function on an LD.	<ul style="list-style-type: none">• (LD) QUICK START indicator is off?• The AV Calendar appears?• The LD contains TOC data?

Optical Disc Maintenance

Holding CDs or CDVs

Hold CDs and CDVs by putting your index finger through the center hole and grasping the edges of the disc with the thumb and other fingers as pictured in the illustration.



Holding LDs

Hold LDs by grasping the outside edge in both hands as illustrated.



Light Exposure

Do not expose the disc to direct sunlight or heat sources such as hot air ducts, or leave the disc in a car parked in direct sunlight where there can be a considerable rise in temperature.

Cracked or Damaged Discs

Do not play cracked or damaged discs, or try to play discs that have been repaired with adhesive glues.

Keeping the Disc Surface Clean

Clean the surface of the disc before playing, using a soft, dry cleaning cloth. Wipe the disc from the center out. Do not use solvents such as benzine, paint thinner, commercially available cleaners, or anti-static spray intended for LP record discs.

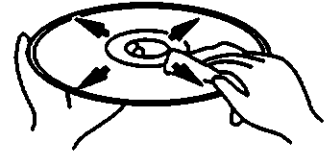

To prevent marring, after playing, remove the disc and put it back into its jacket.

Putting your fingers on, or adhering anything to the surface of the disc such as sticky note pad paper or adhesive tape will deteriorate the quality of the playing surface, and thus the output quality.



Player Maintenance and Safety

On Electrical Safety

- Should any foreign object or liquid fall into the cabinet of the player, unplug the player and have it checked by qualified personnel before operating it any further.
- Unplug the player from the wall outlet if you are not going to use it for an extended period of time. To disconnect the cord, pull it out by the plug. Never pull the cord itself.

On Player Location

- Avoid placing the player where there is:
 - high humidity
 - high temperature
 - excessive dust
 - mechanical vibration
 - direct sunlight
- Allow adequate air circulation to prevent internal heat build-up. Do not place the player on surfaces such as shag rugs, blankets or near materials such as curtains, draperies that may block the ventilation holes.

On Moisture Condensation

- Do not operate the player where the temperature has risen suddenly or in a location where the temperature is radically different from the previous location because moisture may condense in the operating section of the player. Wait about an hour before turning the power on in a different location or keep the rise in the room temperature gradual.
- If you operate the player with moisture condensation, the player and the disc may be damaged. Therefore, remove the disc immediately when there is a possibility of moisture condensation.
- To evaporate moisture rapidly, leave the player turned on without a disc inside.

On Operation

- Remove the disc from the tray after playing it if you are not going to use the player for any length of time. Do not transport the player with a disc in place.
- When the disc tray is in the open position, do not press down on it forcefully, or place heavy objects on it.

On Cleaning

Clean the cabinet, panel, and controls with a soft dry cloth or a soft cloth lightly moistened with a mild detergent solution. Do not use any type of solvent, such as alcohol or benzine, which may damage the finish.

On Repacking

Do not throw away the carton and the packing materials. The carton makes an ideal container to transport the player in.

Glossary

ACS/AMS Automatic Chapter Sensor/ Automatic Music Sensor is a function in the player that allows the laser beam to sense the beginning of chapters or tracks on a disc.

CAV Discs Constant Angular Velocity (CAV) or standard-play discs rotate at a constant 1800 r/min. Each track traced by the laser for a single rotation of the disc produces a single frame. Up to 54,000 frames make up each side of the disc, for up to 30 minutes of play. Each frame has a number that is stored with other data on the disc. When searching for a particular location on CAV discs, you must enter that "frame number".

Chapters Some laser discs are divided into sections, called chapters. These are analogous to tracks on CDs. Such discs usually have a numbered list of chapters on the jacket or label. Each chapter has been numbered for easy location when you use Chapter Search, Repeat or Program functions.

CLV Discs Constant Linear Velocity (CLV) or extended-play discs double maximum playing time to 60 minutes by varying the rotational speed from a maximum of 1800 r/min to a minimum of 600 r/min as the laser beam moves away from the center of the disc. The disc surface therefore moves past the laser head at a constant rate, and each track is longer than its predecessor. For this reason, Variable Speed Play, Freeze Frame, and Step Play are not possible with CLV discs, so when searching for a scene you must enter the time on CLV discs instead of the frame number.

Digital Sound Recordings Sound translated into digital signals has a better signal-to-noise ratio. Therefore, digital sound recordings offer a higher quality reproduction than the alternative, analog recordings (found on LPs and older audio cassette tapes). However, some laser discs have been recorded in the higher-quality digital audio signal as well as the conventional analog type signal. This player reproduces both signals with priority given to the digital signal when it is encountered.

Indexes Signs marked in a chapter or track so that you can find a particular point on the disc easily.

MULTI AUDIO Disc Different sounds are recorded on analog and digital tracks. You can select either sound by switching one to the other.

SAP Second Audio Programs are double soundtrack recordings found on bilingual and karaoke (sing-along) recordings. Two completely different sound programs have been recorded on the disc. By pressing the AUDIO MONITOR button, you can switch from one sound track to the other.

TOC Table of Contents signals are recorded on some LDs. When playing back LDs with TOC signals, additional functions can be enjoyed such as; Shuffle Play and Delete Shuffle Play.

Tracks CDs and CDVs are divided into sections, called tracks. Each track has been numbered for easy location when you use Track Search, Repeat or Program functions. The tracks usually correspond to the selections on the disc.

Specifications

Type
Signal readout
Signal format system
Playing time

CD/CDV/LD Player
Optical (Laser beam reflection)
EIA standard, NTSC color system
(minutes)

LD	CAV	30 cm (12 in) double-sided	60
		20 cm (8 in) double-sided	28
		20 cm (8 in) single-sided	14
	CLV	30 cm (12 in) double-sided	120
		20 cm (8 in) double-sided	40
		20 cm (8 in) single-sided	20
CD	12 cm (5 in) single-sided	74	
	8 cm (3 in) single-sided	20	
CDV	Audio portion	20	
	Video portion	5	
VSD	Video portion	5	

Digital audio specifications

Frequency response 4 Hz to 20kHz (± 0.3 dB)
Signal-to-noise ratio More than 115 dB (EIAJ)*
Dynamic range More than 99 dB (EIAJ)
Wow and flutter Below measurement limit
($\pm 0.001\%$ W.PEAK) (EIAJ)

Video specifications

Horizontal video resolution 425 lines
Signal-to-noise ratio More than 50 dB

Input/output specifications

Video output 1, 2 1.0 Vp-p, 75 ohms, unbalanced
Video output 1.0 Vp-p, 75 ohms (MDP-A1)
Audio output 1, 2 Stereo L, R
Analog: 200 mVrms
(1 kHz, 40% modulation)
Digital: 200 mVrms
(1 kHz, -20 dB)
Audio output Monaural (only for RFU adaptor)
MIX output: 77.5 mVrms (1 kHz,
-20 dB) (MDP-A1 only)
S video output 1, 2 Luminance: 1 Vp-p, 75 ohms,
unbalanced, sync negative
Chrominance: 0.286 Vp-p,
75 ohms, unbalanced
-18 dBm, wavelength 660 nm
Audio digital output (optical)
RFU DC output Mini nini jack DC 5 V (MDP-A1 only)
Headphone output 12 mW (8 ohms)
Impedance = 8 ohms
CONTROL S IN Mini jack
Mic jack Standard jack
1mV (Impedance below 1 kilohm)

* Measured according to EIAJ (Electronic Industries Association of Japan) standards.

Power requirements

Power requirements 120V AC 60 Hz
120/220/240 V AC
adjustable, 50/60 Hz
(MDP-A1)
Power consumption 38 W
Mass 9.5 kg
Dimensions Approx. 430 x 117 x
430 mm
(w/h/d)
Operating temperature +5°C to +35 °C
Ambient humidity 5% to 90%

Remote Commander RMT-M19A/19B



Principle of operation Infrared pulse
Power requirements 3 V DC (2 size AA
batteries)
Dimensions Approx. 68 x 38 x 200
mm
(w/h/d)
Mass Approx. 175 g
(including batteries)

Supplied accessories

Remote Commander RMT-M19A (1) (MDP-600)
RMT-M19B(1) (MDP-A1)
Size AA (R6) batteries (2)
Audio/Video cable (phono plug 3 \leftrightarrow phono plug 3) (1)
AC power cable (1)
AC plug adaptor (1) (MDP-A1 only)

Design and specifications are subject to change without notice.

Index

- 1/SIDE/ALL, 10, 21, 31, 38
- Accessories, 9
- ACS/AMS, 10, 14, 19, 26, 29, 39, 46
- ANALOG, 16, 42
- ATT(Attenuator) switch, 9, 43
- AUDIO MONITOR, 10, 16, 27, 42
- Audio connection, 13
- Audio section, 33
- AUTO PAUSE, 10, 37, 42
- AUTO PGM, 10, 35
- Auxiliary functions, 6
- AV calendar, 17, 28, 34, 35, 38
- AV TIME, 10, 34, 36
- BACK, 10, 24, 32, 39
- Battery, 10, 44
- CAV discs, 7, 17, 18, 25, 46
- CDs, how to play, 26
- CDVs, how to play, 33
- Chapter search, 19
- Chapters, 19, 46
- CLEAR, 10, 20, 22, 24, 30, 31, 32, 35, 37, 39, 40
- CLV discs, 7, 17, 18, 25, 46
- Compact disc, 7, 26
- CX  button, 10, 16
- CX  noise reduction system, 16
- Delete Shuffle, 39
- Digital sound, 12, 13, 16
- Disc classification, 7
- (DISC) SIDE A/B, 8, 10, 15, 17, 23, 38, 43
- Disc tray, 8, 14, 26, 43
- DISPLAY, 10, 17, 19, 24, 28, 32, 34
- ECHOMIC LEVEL control, 42, 43
- Fiber optical connector, 13
- FL DISPLAY, 8, 17, 28, 34
- FRAME/TIME, 10, 20, 30
- Frame/time search, 20
- Freeze frame, 25
- Front panel, 8
 - controls, 8
 - messages, 17, 28, 34
- Glossary, 46
- Index, 28, 34, 36, 46
- INTRO, 10, 37
- Intro scan, 10, 37
- Laser disc, 7, 14
- (LD) QUICK START, 8, 17, 23, 35, 38
- LDs, how to play, 14
- LEVEL control, 8, 42
- Maintenance, 45
- MEMORY PLAY, 25
- MIC jack, 8, 42
- MULTI AUDIO, 7, 42, 46
- MULTI SPEED, 10, 18
- Number keys, 10, 19, 20, 23, 29, 30, 32, 35, 39, 43
- On-screen messages, 17, 28, 34
- OPEN/CLOSE, 8, 10, 14, 26, 33, 42
- Optical/digital discs, 7
- PAUSE, 8, 10, 15, 25, 26, 27
- PGM, 10, 23, 32
- PHONES jack, 8, 42
- Picture stop code, 18
- PICTURE ENHANCE, 10, 15
- PLAY, 8, 10, 14, 26
- POWER button, 8, 10, 14, 26, 42
- Primary functions, 6
- Problems, 44
- Program A/B, 35
- Programmed play, LDs, 23; CDs, 32
- Rear panel, 9
- Remote Commander, 10; sensor, 8, 44
- REPEAT, 10, 21, 31
- REPEAT A↔B, 22, 31
- Repeatable functions, 6
- Replaying, LDs, 21; CDs, 31
- SAP (Second Audio Program), 16, 27, 46
- SCAN, 10, 14, 18, 26, 29
- SEARCH/NEXT, 10, 20, 24, 30, 32, 39
- SHUFFLE, 10, 38
- Shuffle play, LDs, 38; CDs, 39
- Shuttle Ring, 10, 14, 18, 26, 29
- Skip search, 19, 29
- Speaker connection, 13
- SPEED SET, 10, 18
- Step play, 25
- Stereo discs, 16, 27
- STILL/STEP, 10, 25
- STOP, 8, 10, 15, 25, 27
- Table of contents (TOC), 17, 23, 35, 36, 38, 46
- Television buttons, 10
- Television connection, 11
- Time counter, 36
- Tracks, 29, 32, 46
- Troubleshooting, 44
- Variable speed functions, 6
- Variable speed play, 18
- VCR connection, 11
- Video connectors, 9
- Video section, 33
- Video single disc, 7
- Voltage selector, 4, 9
- VSD, 7, 33