

MDP-U3

RMT-M16A

SERVICE MANUAL

E Model

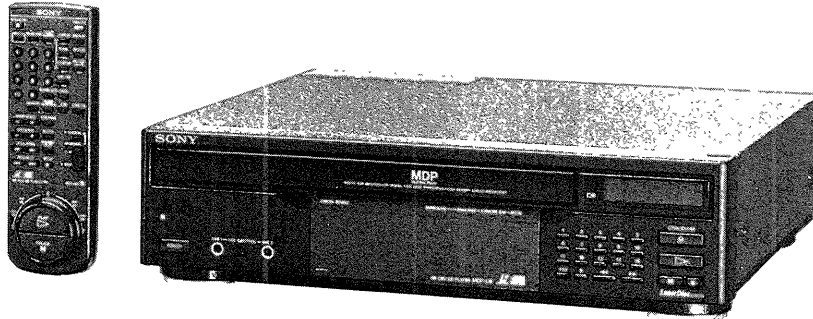

SPECIFICATIONS

Type
Signal readout
Signal format system
Playing time

CD/CDV/LD Player
Optical (Laser beam reflection)
EIA standard, NTSC color system
(minutes)

LD	CAV	30 cm (12 in) double-sided	60
		20 cm (8 in) double-sided	28
		20 cm (8 in) single-sided	14
	CLV	30 cm (12 in) double-sided	120
		20 cm (8 in) double-sided	40
		20 cm (8 in) single-sided	20
CD	12 cm (5 in) single-sided	74	
	8 cm (3 in) single-sided	20	
CDV	Audio portion	20	
	Video portion	5	

Digital audio specifications

Frequency response 4 Hz to 20kHz (± 0.3 dB)
Signal-to-noise ratio More than 110 dB (EIAJ)*1*2
Wow and flutter Below measurement limit
($\pm 0.001\%$ W.PEAK) (EIAJ)*1

Video specifications

Horizontal video resolution 425 lines
Signal-to-noise ratio More than 49 dB

Input/output specifications

Video output 1, 2 1.0 Vp-p, 75 ohms, unbalanced
Audio output 1, 2 Stereo L, R
Analog: 200 mVrms
(1 kHz, 40% modulation)
Digital: 200 mVrms
(1 kHz, -20 dB)
S video output 1, 2 Luminance: 1 Vp-p, 75 ohms,
unbalanced, sync negative
Chrominance: 0.286 Vp-p,
75 ohms, unbalanced

— Continued on next page —

CD/CDV/LD/PLAYER
SONY®

Audio digital output (optical)	-18 dBm, wavelength 660 nm
AUX audio input	Impedance = 47 kilohms
MIC 1/MIC 2 jack	Standard jack 1 mV (Impedance below 1 kilohm)
MIC control jack	Applicable to karaoke microphone (F-KM1, etc.)
Headphone output	28 mW (32 ohms) Impedance = 8 ohms
CONTROL S IN input	Mini jack

Power requirements

Power requirements	120/220/240 V AC adjustable, 50/60 Hz
Power consumption	40 W
Mass	8 kg
Dimensions	Approx. 430 × 115 × 400 mm (w/h/d)
Operating temperature	+5°C to +35 °C
Ambient humidity	5% to 90%

Remote Commander RMT-M16A

Principle of operation	Infrared pulse
Power requirements	3 V DC (2 size AA batteries)
Dimensions	Approx. 68 × 38 × 200 mm (w/h/d)
Mass	Approx. 175 g (including batteries)

*1 Measured according to EIAJ (Electronic Industries Association of Japan) standards.

*2 Measured in NORMAL mode.

Supplied accessories

- Remote Commander RMT-M16A (1)
- Size AA (R6) batteries (2)
- Video cable (phono plug 1 ↔ phono plug 1) (1)
- Audio cable (phono plug 2 ↔ phono plug 2) (1)
- AC plug adaptor (1)

Design and specifications are subject to change without notice.

WARNING !!

WHEN SERVICING, DO NOT APPROACH THE LASER EXIT WITH THE EYE TOO CLOSELY. IN CASE IT IS NECESSARY TO CONFIRM LASER BEAM EMISSION, BE SURE TO OBSERVE FROM A DISTANCE OF MORE THAN 25 cm FROM THE SURFACE OF THE OBJECTIVE LENS ON THE OPTICAL PICK-UP BLOCK.



CAUTION:

The use of optical instrument with this product will increase eye hazard.

CAUTION

Use of controls or adjustments or performance of procedures other than those specified herein may result in hazardous radiation exposure.

SAFETY-RELATED COMPONENT WARNING!!

COMPONENTS IDENTIFIED BY MARK  OR DOTTED LINE WITH MARK  ON THE SCHEMATIC DIAGRAMS AND IN THE PARTS LIST ARE CRITICAL TO SAFE OPERATION. REPLACE THESE COMPONENTS WITH SONY PARTS WHOSE PART NUMBERS APPEAR AS SHOWN IN THIS MANUAL OR IN SUPPLEMENTS PUBLISHED BY SONY.

SAFETY CHECK-OUT

After correcting the original service problem, perform the following safety checks before releasing the set to the customer:

1. Check the area of your repair for unsoldered or poorly-soldered connections. Check the entire board surface for solder splashes and bridges.
2. Check the interboard wiring to ensure that no wires are "pinched" or contact high-wattage resistors.
3. Look for unauthorized replacement parts, particularly transistors, that were installed during a previous repair. Point them out to the customer and recommend their replacement.
4. Look for parts which, though functioning, show obvious signs of deterioration. Point them out to the customer and recommend their replacement.
5. Check the line cord for cracks and abrasion. Recommend the replacement of any such line cord to the customer.

TABLE OF CONTENTS

<u>Section</u>	<u>Title</u>	<u>Page</u>	<u>Section</u>	<u>Title</u>	<u>Page</u>
1.	GENERAL		4.	PRINTED WIRING BOARDS AND SCHEMATIC DIAGRAMS	
	About Operating Voltage	5	4-1.	Frame Schematic Diagram	55
	Introduction	5	4-2.	Printed Wiring Boards and Schematic Diagrams	58
	Installation and Connection	7		SV-63, CK-44, FG-41, MT-28, MT-30 Boards	59
	To Play Karaoke	10		MB-701 (Video) Board	68
	To Play a Laser Disc	13		MB-701 (System Control), LS-706, MT-52, SW-717, SW-718 Boards	78
	To Play a Compact Disc	18		MB-701 (Audio), HP-706 Boards	88
	To Play a Compact Disc Video	21		FP-709, FP-710, PW-701, MA-702, KP-704, AX-702 Boards	97
	To Play Any Disc (Advanced Functions for LD, CD, or CDV Play)	22		PS-701, TR-710, VS-702 Boards	104
2.	DISASSEMBLY		4-3.	Semiconductors	109
2-1.	Tray Cover	25	5.	EXPLODED VIEWS	
2-2.	Upper Case, Front Panel Assembly	25	5-1.	Cabinet, Front Panel Assemblies	111
2-3.	MB-701 Board	26	5-2.	Chassis (1)	112
2-4.	MD Chassis, Optical Device Chassis	26	5-3.	Chassis (2)	113
2-5.	Turntable, Spindle Motor, Skew Motor, SV-63, FG-41 Boards	27	5-4.	MD Chassis	114
2-6.	Removal of the Tray	27	5-5.	Optical Block	115
2-7.	Removal of the Disc When a Problem Has Occurred with the Disc Loaded	27	6.	ELECTRICAL PARTS LIST	116
2-8.	Alignment of the Loading Gear Phase	28		Hardware List	138
3.	DIAGRAMS		7.	ELECTRICAL ADJUSTMENTS	
3-1.	Circuit Boards Location	29	7-1.	List of Servicing Jigs	139
	Main Parts Location	29	7-2.	Cautions on Adjustment	139
3-2.	Overall Block Diagram	30	7-3.	MD Adjustment Cable	139
3-3.	RF Amp, Servo Block Diagram	34	7-4.	Power Supply Check (PS-701 Board)	140
3-4.	System Control Block Diagram	37	7-5.	System Control System Adjustment	140
3-5.	System Control Microcomputer Pin Functions (MB-701 Board IC601 MB89795)	39	7-5-1.	Microprocessor Clock Adjustment (MB-701 Board)	140
3-6.	Video Block Diagram	41	7-6.	Servo System Adjustment	140
3-7.	Digital Signal Processor, AFM Audio Block Diagram	43	7-6-1.	LD Servo System Adjustment	141
3-8.	Digital Signal Processor Microcomputer Pin Functions (KP-704 Board IC603 CXP5084)	47	7-6-2.	CD Servo System Adjustment	145
3-9.	Mode Control Microcomputer Pin Functions (FP-709 Board IC001 CXP50116-409Q)	48	7-7.	Video System Adjustment	147
3-10.	Mode Control AD Key	50	7-7-1.	Video Output Level Adjustment (MB-701 Board) ..	147
3-11.	Mode Control Block Diagram	51	7-8.	Parts Arrangement Diagram for Adjustments	148
3-10.	Power Supply Block Diagram	53			

This section is extracted from instruction manual.

SECTION 1
GENERAL

Introduction

This introduction explains the organization of this manual and the principles of operation of the Multi Disc Player (MDP).

About These Instructions

Consumer electronics manuals have been notorious for being hard to comprehend. Having recognized this fact, we have made an attempt with this manual to avoid the usual pitfalls by trying to not pretend that the equipment being described is as simple as a bread toaster. Most likely this is your first Multi Disc Player and may be the only one you will own. With that in mind, we have striven to write the instructions in straight-forward English while trying to keep the procedures simple and systematic.

The MDP-U3 is a Multi Disc Player with Karaoke features. In this manual, you can read the Karaoke instructions first, then the instructions for each type of disc operation - playing laser discs (LDs), compact discs (CDs), compact disc videos (CDVs, VSDs). The following summarizes what you will find in this manual.

Karaoke Features

Karaoke microphone

The optional Karaoke microphone (F-KM1) enhances Karaoke entertainment with features like Repeat and Key control.

15 Direct select buttons

You can play any given selection quickly and easily by simply pressing the number of that selection on the player.

Digital surround selector

Three digitally enhanced surround effects (Simulated, Karaoke Bar, Movie), are available to produce the best acoustics.

Digital key control

Use this feature to adjust the music to your singing key.

These controls are located on the player, the Remote Commander and the optional Karaoke microphone.

20 Selection reservation

For non-stop Karaoke entertainment, up to 20 selections can be reserved even while one is already being played.

Vocal feature

Pressing the VOCAL button, you can listen to the singer's voice recorded on the MULTI AUDIO disc. This is convenient for correcting the words or melody you missed.

ONTA button

Using the ONTA button, you can enjoy Karaoke with the discs including vocals recorded in multiplex.

AUX inputs

Other auxiliary equipment such as tape decks can also be used to playback Karaoke music. You can still use the Key Control and Karaoke Pon features as you would with discs.

Karaoke Pon

You can even enjoy Karaoke with non-Karaoke discs, as Karaoke Pon removes vocals from stereo recorded discs/tapes.



How to Use the AC Power Plug Adaptor

- If the AC plug on your Multi Disc Player does not fit into the wall outlet, attach the supplied AC plug adaptor.

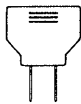

If you have any questions or problems concerning your unit, please contact your nearest Sony dealer.

What to Do First

Once you have read through this page, read the following, "The Principles of Operation" (page 4), then go ahead and connect up the Multi Disc Player to your television and/or stereo system using the connection diagrams on pages 70 and 71. After you have done this, you will be ready to play a disc. Begin with the section, "To play Karaoke" or "How to Load and Play an LD (or a CD)".

About Operating Voltage

Before operating the Multi Disc Player, make sure that the operating voltage of your unit is identical with that of your local power supply.

How to Determine the Correct Operating Voltage

- Before operating the unit, find out the local voltage, and if necessary reset the selector at the rear of the Multi Disc Player to the voltage corresponding to your local power supply (120, 220 or 240 volts AC).
- To reset the voltage selector, disconnect the power cord and turn the selector with a blade screwdriver so that the arrow on the rear panel points to the appropriate voltage.

The Principles of Operation

Beyond the play of discs, the functions of the Multi Disc Player range from simple to advanced. Some functions vary depending on what type of disc (laser disc, compact disc, or compact disc video) you are playing. Nevertheless, keep in mind that the majority of the buttons have been designed to achieve a comparable effect for each type of disc you are playing. Therefore, the following paragraphs can briefly summarize what the basic Multi Disc Player functions allow you to do. (Control names that differ from the function name appear in uppercase letters.)

Primary Functions are so-called because they entail the traditional functions of all disc players.

Karaoke Functions provide Karaoke entertainment using Karaoke laser discs and compact discs, or by converting regular stereo recorded discs into Karaoke discs. These functions can also be used with auxiliary equipment like tape decks.

Variable Speed Functions group operations according to the fact that they let you vary play speed, therefore, easily locate ("search") scenes or tracks as you watch or listen.

Repeatable Functions are memory functions that let you play selections repeatedly, according to a play list or randomly. Playback can be started from the point you stopped. Because the system finds and plays selections according to your request, some repeatable functions also serve as "search" functions.

Auxiliary Functions are additional functions that simply add to what you can do with the Multi Disc Player.



Primary Functions	Karaoke Functions	Variable Speed Functions	Repeatable Functions	Auxiliary Functions
Power	Next Selection Reserve (PGM/RESERVE)	Variable Speed Scan (SHUTTLE RING)	Pre-Programmed Play (AUTO PGM, PGM)	Sound Quality Functions (AUDIO MONITOR, ANALOG, CX)
Open/Close	Singing Key	Still/Step Scan (STILL/STEP)	Intro Scan (INTRO)	On-Screen Display (DISPLAY)
Play	Voice Control (DIGITAL ECHO)	Variable Speed Play (MULTI SPEED, SPEED SET)	Random Play (SHUFFLE)	Audio/Video Time Counter (AV TIME)
Pause	Karaoke with Regular Discs (KARAOKE PON)		Chapter/Track Search	
Stop	Vocal Support Feature (VOCAL)		Frame/Time Search	
	Karaoke with Auxiliary Equipment (INPUT SELECTER)		Memory Play (MEMORY PLAY)	
	Atmosphere Control Feature (SURROUND)		Auto Pause (AUTO PAUSE)	
	Karaoke with Multiplex discs (ONTA)		Repeat Play (1/ALL, REPEAT, REPEAT A↔B)	

Introduction to Your Player

The MDP-U3 Multi Disc Player integrates the functions of three machines in one: laser disc, compact disc, and compact disc video player. The entertainment potential afforded by the combined capabilities of this multi-faceted machine amount to some 35 to 40 functions. Below follows an explanation of the kinds of discs the Multi Disc Player plays.

The MDP-U3 Plays Three Classes of Optical/Digital Discs*

The MDP-U3 Multi Disc Player plays all three types of optical discs (including Karaoke discs) currently available for home entertainment. The following table illustrates their types and features.

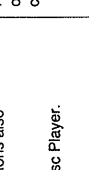
Disc Class	Disc Logo	Disc Type	Size	Play Side	Play Time
Laser Discs For movies, operas, and concerts		LD Single	8 in. (20 cm)	Single Side	CAV 14 min CLV 20 min
		8-inch LD	8 in. (20 cm)	Double Side	CAV 28 min CLV 40 min
	12-inch LD	12 in. (30 cm)	Double Side	CAV 1 hr CLV 2 hr	
	Compact Discs For music		CD Single	3 in. (8 cm)	Single Side
CD			5 in. (12 cm)	Single Side	74 min
Compact Disc Videos For music videos and educational material (Digital Audio)		CDV	5 in. (12 cm)	Single Side	Video+Audio 5 min Audio 20 min
		VSD	5 in. (12 cm)	Single Side	Video + Audio 5 min

Multi Audio Discs

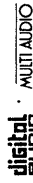

On laser discs bearing this logo, the analog tracks are recorded in multiplex, and the digital tracks are recorded in stereo.

* These apply only to those discs recorded in the NTSC standard. The MDP-U3 cannot play CED, VHD discs or PAL video discs, CD-ROM, CD-GRAFHCS, CD-I discs or aluminum-lined discs.

Installation and Connection

Front and Rear Panel Controls and Supplied Accessories

Front Panel

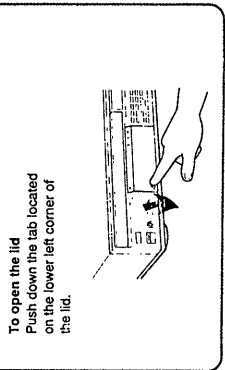
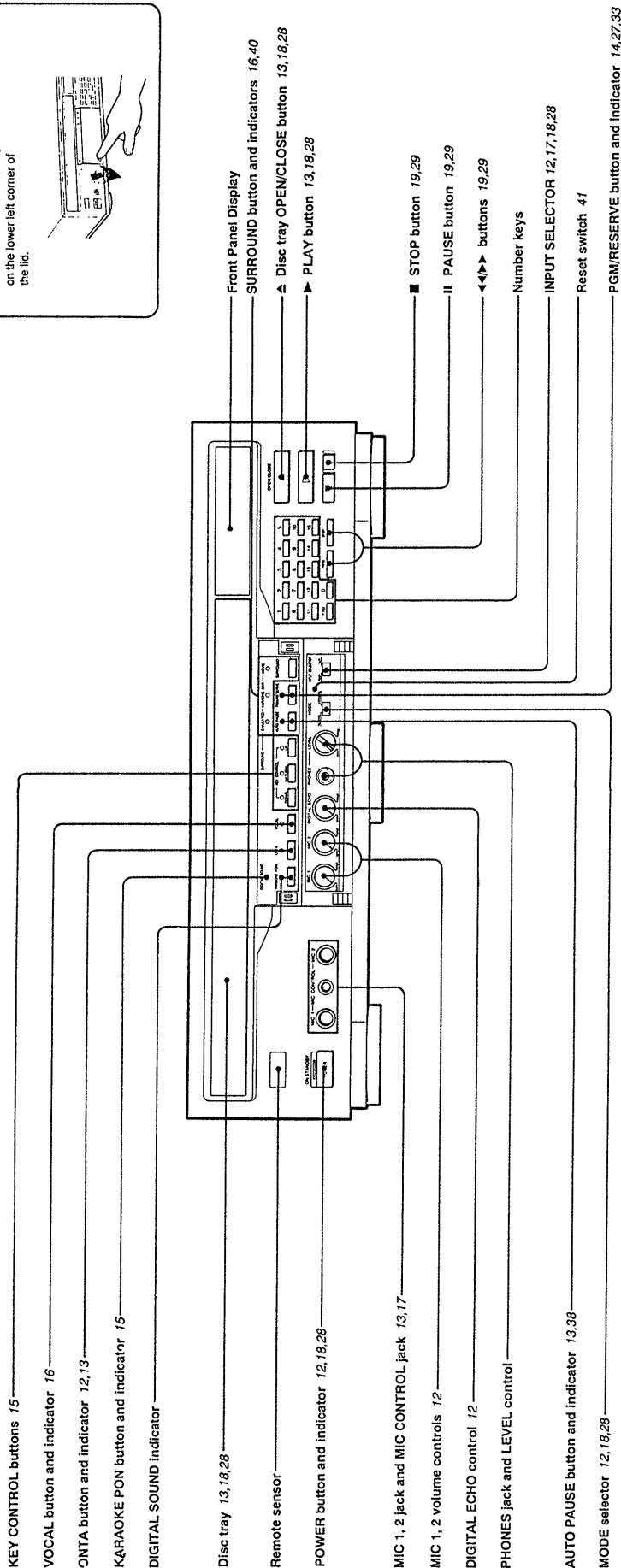

Accessories

Make sure the shipping box contains the following accessories:



Remote commander
RMT-M16A (1)



Size AA (R6) batteries (2)
For Remote commander



Video connecting cable (1)
(phone plug 1 ↔ phone plug 1 Yellow)



Audio connecting cable (1)
(phone plug 2 ↔ phone plug 2 Red/white)



AC plug adaptor (1)

Front and Rear Panel Controls and Supplied Accessories (continued)

Rear Panel

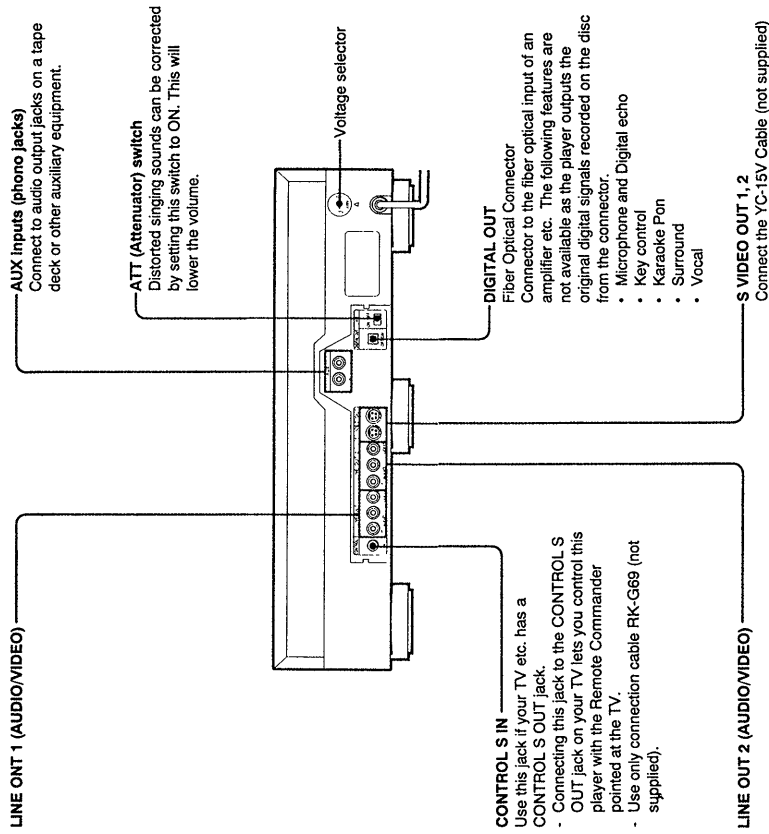

Controls on the Remote Commander

You can use the Remote Commander (Remote) to control the player or the identical buttons on the player itself.

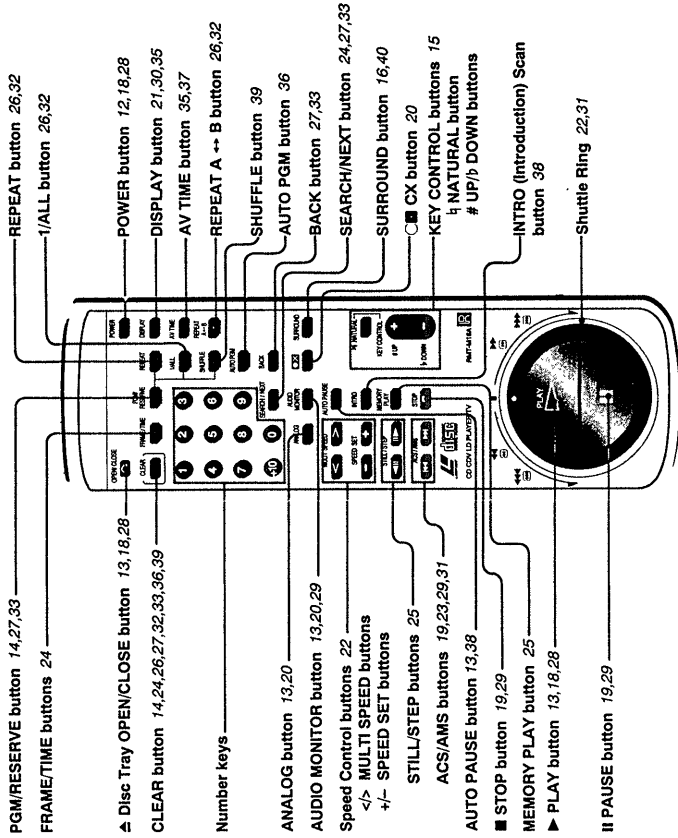

The yellow bar under a button indicates that the function of that button can be released by pressing the CLEAR button.

To Activate the Remote Commander

Open the back cover, and insert two size AA (R6) batteries according to the polarity indicated in the illustration. The batteries will last for about 6 months. If the range of the Remote Commander becomes noticeably short, replace all the batteries with new ones. If the Remote Commander is not to be used for a long time, remove the batteries to avoid damage from possible battery leakage.

Remote Commander Precautions

Do not let sunlight or powerful artificial light fall directly on the Remote Commander sensor on the front panel (of the player) as it may interfere with Remote Commander operation.

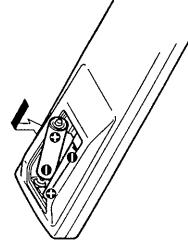

Insert two size AA (R6) batteries.

How to Connect the Television

To play LDs or CDVs, hook up a television to the Multi Disc Player. Take out the supplied yellow video connecting cable and the red, white audio cables. Use these to connect the player to the television.* Once you have hooked-up the television, set the input selector on the TV to "Video". Before connecting or disconnecting any of the cables, turn off all equipment.†

Television Hook-Up

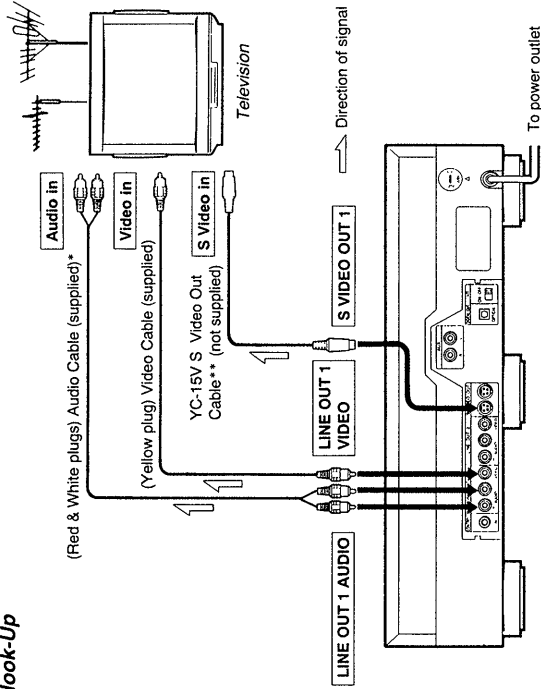

Television/VCR Hook-Up

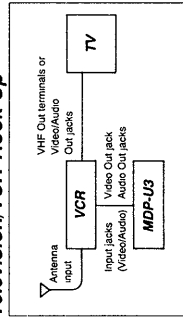

Connect to the external video/audio inputs of a VCR.

Connecting Precautions

- Make sure all equipment is turned off before connecting or disconnecting any cables.
- Connection methods may differ; when in doubt about a connection consult the TV or VCR manufacturer's manual.
- If the sound or picture is disturbed by noise, try moving the equipment farther apart.
- Firmly insert plugs into the jacks. A loose connection may cause noise.
- To prevent later interference with TV broadcast reception, turn off all equipment connected but not currently in use.

* If the TV only has a monaural phono jack for audio input, use a RK-C70/C72 or VMC-910MS/915MS Connecting Cable (not supplied).

** If your TV has an S Video Input jack, obtain a YC-15V S Video Connecting Cable, and use this instead of the supplied video cable to connect your television to the S VIDEO OUT connector on the Multi Disc Player.

How to Connect Audio Equipment

To achieve full stereo sound from your Multi Disc Player, hook up a stereo system following the diagram below. Connecting a tape cassette deck to the AUX input, you can enjoy Karaoke tapes just like LDs or CDs. Take out the supplied red and white audio connecting cable and use this to connect the Multi Disc Player to your amplifier or receiver. Before connecting or disconnecting any of the cables, turn off all equipment.

To Achieve Digital Sound

Digital sound recordings afford high quality sound reproduction. (see Glossary, p. 43). If your amplifier also has a fiber optical connector, or if you have a D/A converter unit with optical input, according to the diagram below, connect the POC-15 Audio Fiber Optical Cable (not supplied) between the DIGITAL OUTPUT connector on the Multi Disc Player and the amplifier or D/A converter. Note that digital signals are always output from the Multi Disc Player except when you play discs that are not digitally recorded. Such discs output analog sound. Sound from a microphone cannot be output from the DIGITAL OUT connector. To output sound from a microphone, connect the player to the amplifier with an Audio Cable (Red & White plugs).

Audio Equipment Hook-Up

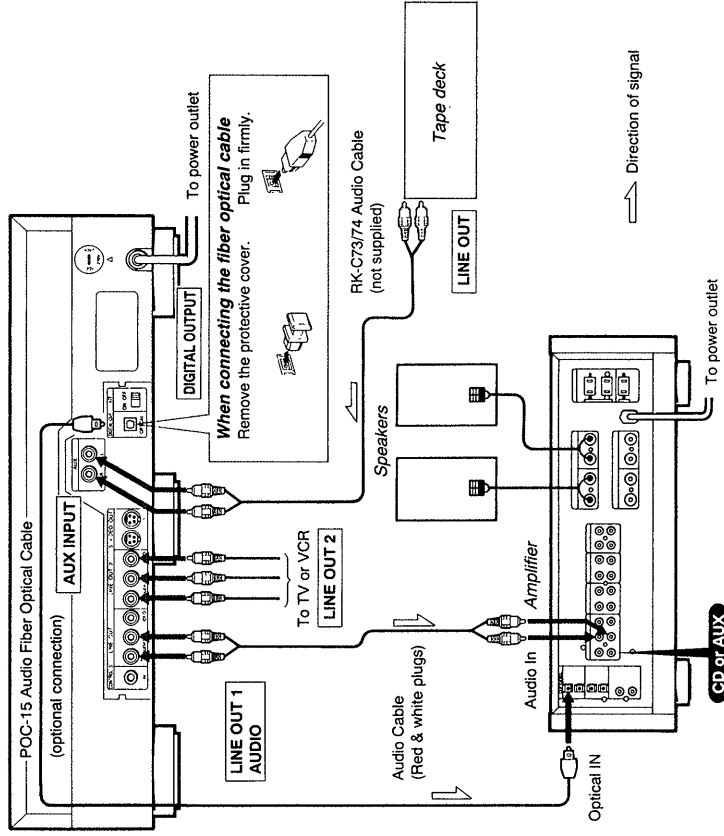

Connecting Precautions

- Make sure all equipment is turned off before making any of the above connections.
- Firmly insert plugs into the jacks. A loose connection may cause noise.
- When listening to a radio broadcast, switch off the Multi Disc Player to get better reception.
- If you have used the supplied audio cable for connecting a TV to the Multi Disc Player, obtain a RK-C73/74 Connecting Cable (not supplied) for an amplifier (or tape deck).

To Play Karaoke

To Enjoy Karaoke

1 Turn on the TV and stereo system
TV: Set to "Video".
Stereo system: Turn on the amplifier or receiver and select CD or AUX for audio output.

2 Turn on the player
Turns from red to green
ONSTANDBY
POWER

3 Set the INPUT SELECTOR to MAIN
INPUT SELECTOR
MAIN AUX
Select AUX when playing from a tape deck or other auxiliary device.

4 Set the MODE selector to KARAOKE
MODE
SIGNAL KARAOKE

5 Connecting the microphone
Karaoke microphone F-KM1 (not supplied)
Control plug
Optional microphone

6 Open the disc tray and place the disc on the tray
LD
CD/CDV
Carefully center a single disc on the tray. The disc will not play if it is not seated properly.
• Always insert one disc at a time. Inserting more than may damage the player.

7 Choose selections to play
The disc tray will close automatically and start playing.
Single steps in Karaoke mode
The player will automatically pause after playing the current step. If your selection has been reserved, that selection will be played without pausing. For play time next selection, press the PLAY (▶) or PAUSE (⏸) button, or make a direct selection with the direct select buttons on the player (or number buttons on the Remote Commander).
To cancel single stop mode, press the AUTO PAUSE button on the remote commander. The AUTO PAUSE indicator on the player will go out and selections will be played continuously without interruption.
About the sound of karaoke discs
Karaoke discs can be recorded using one of three formats: multi audio (MULTI AUDIO), multiplex and stereo. Multi audio and multiplex discs include vocals. Stereo discs do not. If the disc loaded in is a multi audio or multiplex disc, this Multi Disc Player detects that and automatically select the sound mode to output only the back-up without vocals. At this time, the indicator above the ONTA button lights up. To enjoy Karaoke listening to the singer's voice recorded on the disc, press the VOCAL button (or use the AUDIO MONITOR or ANALOG button on the Remote Commander to alternate the sound).

8 Adjust the microphone volume
Adjust the volume for each respective microphone.
Sound from a microphone cannot be output when the player is connected to the amplifier with a Fiber Optical Cable. To output sound from a microphone, use an Audio Cable (Red & White plugs) for connection.

9 Adjust the microphone echo
Adjust the strength of the echo with the digital echo control. Echo will be applied to both MIC 1 and MIC 2.

Display information
The following information is displayed by pressing the DISPLAY on the remote commander.
Current track number
C-3
PROGRAM 3
1:22:58
PLAY
A PAUSE
Playing mode
Sound effects (see table below)
Reserved selection number
• Disc without time data to the second will be indicated as "0:22".

Display	Action
SIMULATED	Press SURROUND button
KARAOKE BAR	Press SURROUND button
MOVIE	Press SURROUND OFF
SURROUND OFF	Press KEY CONTROL button
KEY +1	Press KARAOKE PON button
KARAOKE PON	Press KARAOKE PON button
VOCAL	Press VOCAL button

Display window in KARAOKE playing
(microphone is connected)
The selection number
Level display of key control
AV calendar (Displayed only when LD with TOC is played.)

10 Howling occurs
Correct by doing the following:
- Move the microphone away from the speakers
- Lower the MIC or DIGITAL ECHO volumes
- Lower the volume of the speakers

11 When listening through headphones
Once the headphones are connected, the volume must be adjusted with the LEVEL knob next to the PHONES jack.

12 If the output is distorted
The output may sound distorted when listening through your TV speakers. Correct this by setting the ATT (Attenuator) switch on the rear panel of the player to ON. (This will lower the volume which should now be adjusted with the volume control on the TV.)

13 If the picture on the TV flickers
The picture appearing on the TV screen may flicker when listening through your TV speakers at the MIC volume is set too high. Correct this by setting the ATT switch on the rear panel to ON, or lower the MIC volume.

Useful Features for Enjoying Karaoke

These features are available only in the KARAOKE mode.

How to Reserve the Next Selection(s) (Reserve)

Lets you reserve the next, up to twenty selection(s) even while one is currently in play. Available also with the Remote Commander.

1 Press the PGM/RESERVE button.

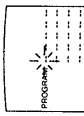

The indicator flashes. "RESERVE" appears on the TV screen.

2 Press the number key(s).

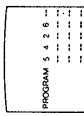

Press numbers for all the selections you want to play. For example, press 5, 4, 2, and 6 to play those chapters in that order. You can reserve up to twenty selections.

- If you reserved the wrong selection, press SEARCH/ NEXT or BACK on the Remote Commander until the number you want to change flashes, then enter the correct numbers.
- To cancel all the entries, press CLEAR.

3 Press PGM/RESERVE again.

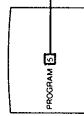

The display window of the player

The selection currently in play

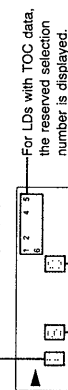

The next selection number reserved

Level display of key control

For LDs with TOC data, the reserved selection number is displayed.

- As the selection currently in play finishes, the reserved selections starts automatically from the beginning.
- The player will stop automatically after playing all the selections reserved.
- You can use this function during the stop mode. Press PLAY (▶) after doing the step 1 to 3 so that the player starts playing in order you reserved.

- To enter a number greater than 15
Press +10 and one of the number keys.

For example: +10 → [9] "19"
+10 → +10 → [0] "20"

If you make a mistake while entering numbers, press +10 repeatedly until 0- is displayed, then enter the correct number.

- To check the selection number(s) you reserved Press PGM/RESERVE. The selection number(s) is displayed on the TV screen in order you reserved. To turn off the display, press PGM/RESERVE again.

- To cancel all the reservation Press CLEAR on the Remote.

How to Control the Back-up Keys (Key Control)

Available also with the Remote Commander or the optional Karaoke Microphone.

To lower the back-up key, press the DOWN button.

To raise the back-up key, press the UP button.

The indicator above each button lights up. (The indicator NATURAL is always lit in the KARAOKE mode.)

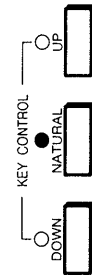

- The key level indication will appear on the display window and the TV screen. The one on the TV screen disappear after three seconds.
- When playing in SIMULATED or MOVIE surround, KEY CONTROL is not available.
- Eight lower and eight higher keys can be attained. (total: 17 steps)
- To return to the original key, press the NATURAL button.
- The key will return to the original level after the current selection is played unless it is played repeatedly.

Press the button repeatedly to find the back-up key that suits your singing.

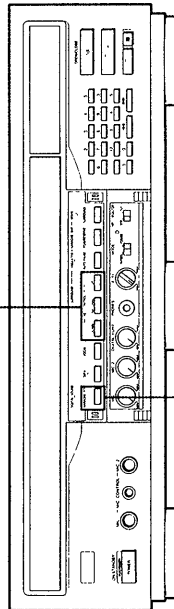

How to Enjoy Karaoke with Regular Discs (Karaoke Pon)

Lets you enjoy Karaoke fun with regular non-Karaoke discs having vocals in them. (LD, CD)

KARAOKE PON

Lights up



Notes on the usage of KARAOKE PON

- Always use this feature on stereo recorded discs. On monaural discs, the level of the vocal and instrumental portions will both be lowered.
- The vocal portion of the disc may not erase completely for stereo discs with the following characteristics: tracks containing only a few instruments, duet selections, selections with strong echo and chorus emphasis, and selections where the singer's voice deviates from the center.
- When using the KARAOKE PON, the stereo effect reduces.

Other auxiliary equipment such as tape decks can also be used to playback Karaoke music. You can still use the Key Control and Karaoke Pon functions as you would with discs.

Useful Features for Enjoying Karaoke (continued)

How to Use the Surround Effect

Choose from three acoustic effects for enhanced listening quality. Available also with the Remote Commander and operates the same in the NORMAL mode.

Each time the SURROUND button is pressed, the mode changes in the following order.

↑ SIMULATED → KARAOKE BAR → MOVIE → SURROUND OFF

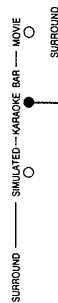

The indicator is lit for the mode selected. To select the SURROUND OFF, make all the indicators go out.

Here is what each surround mode offers:

- SIMULATED** : Good for playing software recorded in monoaural. Enhances the dynamic range for monoaural programs like old movies and news programs.
- KARAOKE BAR** : Creates the effect of singing in a bar. Gives your song a rich carrying tone.
- MOVIE** : Suitable for movie software. Emphasizes the bass and extends the dynamic mid range.
- SURROUND OFF** : Cancels the surround effect.

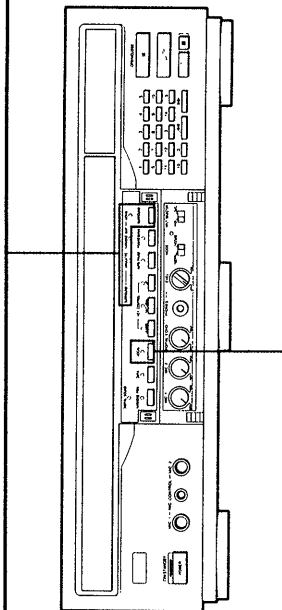

How to Listen to the Original Vocals (Vocal)

- Only for MULTI AUDIO discs

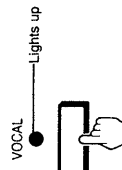

Using the MULTI AUDIO or multiplex disc, you can listen to the singer's voice recorded in the analog sound. This is convenient for correcting the words or melody you missed.

- The Vocal feature is available also for multiplex CDs.

How to Enjoy Karaoke with Auxiliary Equipment (AUX audio input)

(AUX audio input)

Other auxiliary equipment such as tape decks can also be used to playback Karaoke music. You can still use the Karaoke functions as you would with discs.

1 Connect the tape deck to the AUX INPUT jacks on the rear panel.

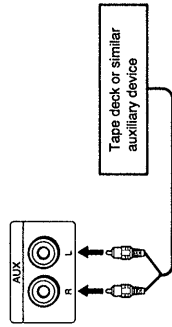

2 Set the INPUT SELECTOR to AUX.

To resume playing discs, select MAIN.

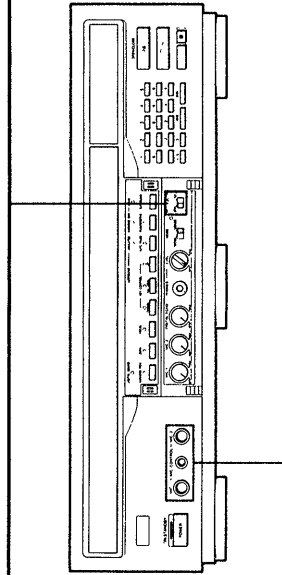

Using the Optional Karaoke Microphone (F-KM1)

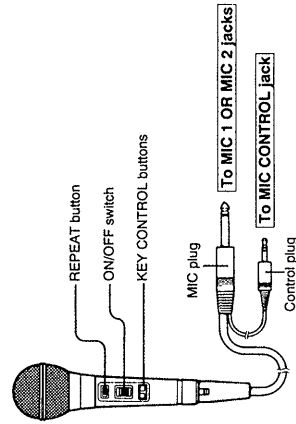

Repeat singing operation

You can go back to any point of a selection using the REPEAT button on the Karaoke microphone. Hold down the REPEAT button and release it at the desired point to repeat singing a certain phrase.

Key control

You can control the back-up key by pressing the KEY CONTROL buttons on the Karaoke microphone. This is the same operation as KEY CONTROL on the player (page 15).

To Play a Laser Disc

This section shows you how to conduct all the procedures associated with playing LDs.

In this manual, **Remote Only** indicates that the functions explained in the section are available only with the Remote Commander (Remote).

How to Load and Play an LD (Laser Disc)

*After you have connected the Multi Disc Player to the TV and/or stereo system, you can begin playing a laser disc.

1 Set the INPUT SELECTOR to MAIN, the MODE selector to NORMAL.

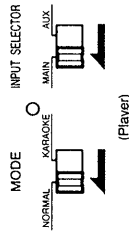

2 Turn on the TV and/or stereo system.

TV Set the input selector on the TV to "Video".
Stereos System Turn on the amplifier or receiver and select CD or AUX for audio output.

3 Turn on the multi disc player.

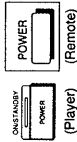

Press the **POWER** button on the player or Remote.

4 Open the disc tray.



Press the **OPEN/CLOSE** button.

5 Place a disc on the tray.

Carefully center a single disc on the tray. If you insert more than one disc, or if the disc is not seated properly, it may not play or it may damage the player and/or the disc.

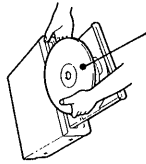

Play side faces up.

What is this indication?

NO DISC

This indication appears in the front panel display when the tray is empty.

6 Start playback.



Press **PLAY**.

To Advance or Reverse



Hold down the **◀** or **▶** button on the player or rotate the Shuttle Ring on the Remote.

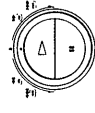

To Advance or Go Back a Chapter at a Time



Press the **ACS/AMS** button on the Remote.

To Interrupt Play

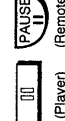

Press **PAUSE (II)**. The sound mutes and the picture freezes. To resume playback, press **PAUSE (II)** or **PLAY (▶)**.

To Stop Playback



Press **STOP (■)**. To play again from the beginning, press **PLAY (▶)**.

To Stop Play and Remove the Disc



Press **OPEN/CLOSE (⏏)**. Remove the disc and close the empty tray.

To Have the Player Pause Before Starting

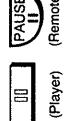

Press the **PAUSE (II)** button on the player or the Remote immediately after doing step 5 on page 18. The tray closes and the player waits at the start of the disc until you press **PAUSE (II)** or **PLAY (▶)**.

To Activate Play with an Optional Timer

Set the timer with the **AC power cord** connected to the player.

When the timer supplies power at the preset time, the player starts playing the disc. If there is no disc in the player, the player goes off automatically.

To Play a Stereo LD or a Second Audio Program (SAP) LD

Press **PLAY** (▶), then press the **AUDIO MONITOR** button on the Remote. This function alternates the sound output on a disc that has been recorded on two sound tracks, such as bilingual discs.*

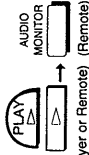

The procedure below indicates how the output and the display changes with each press. The active track will appear on the TV screen for three seconds and then disappear.

Procedure	Display	Stereo Disc	Output Sound	SAP Disc
1 Press PLAY (▶).	No message	Stereo (Both channels)	Soundtrack 1 (left channel) Soundtrack 2 (right channel)	
2 Press AUDIO MONITOR .	1/L	Left channel	Soundtrack 1 (left channel)	
3 Press AUDIO MONITOR again.	2/R	Right channel	Soundtrack 2 (right channel)	
4 Press AUDIO MONITOR again to return to stereo status.	1/L 2/R	Stereo (Both channels)	Soundtrack 1 (left channel) Soundtrack 2 (right channel)	

To Switch from Digital to Analog Sound



Press the **ANALOG** button on the Remote to switch the player to analog or digital sound. Digital affords a better quality sound reproduction. If the LD contains a digital sound signal, the player automatically sends that output to the amplifier or receiver. When you press the **ANALOG** button on the Remote, you can switch to analog sound. With certain discs there may be a difference in volume.



Discs with a CX (CX) Label

Discs bearing the **CX** (CX) label are recorded with the CX Noise Reduction system, which gives lower noise levels and higher dynamic range. The player detects **CX** discs and activates the CX noise reduction system automatically. If you press the **CX** button on the Remote at this time, "CX ON" will appear on the TV screen for three seconds.

Understanding Displays and Messages When Playing LDs

Remote Only

You can determine player operating status or disc information in one of two ways: (1) by displaying the information on the TV screen, or (2) by looking at the front panel display.

To View On-Screen Information...



Press **DISPLAY** on the Remote. To turn off the display, press **DISPLAY** again.

Reading the On-Screen Messages

The illustration below is an example of what appears on screen while the player is operating. The table below is a key to the messages that appear on the right.

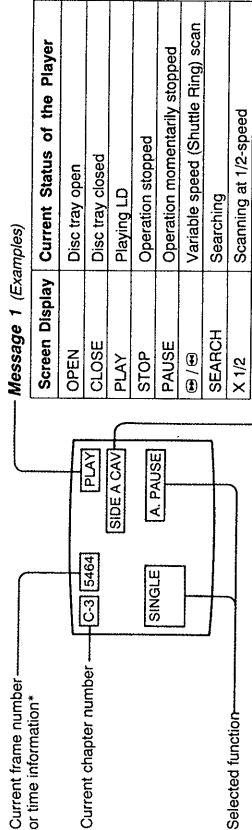

Message 1 (Examples)

Screen Display	Current Status of the Player
OPEN	Disc tray open
CLOSE	Disc tray closed
PLAY	Playing LD
STOP	Operation stopped
PAUSE	Operation momentarily stopped
SEARCH	Variable speed (Shuttle Ring) scan
X 1/2	Searching
	Scanning at 1/2-speed

Message 2 (Examples)

Screen Display	Currently Playing
SIDE A CAV	Standard-play disc side A**
SIDE B CAV	Standard-play disc side B
SIDE A CLV	Extended-play disc side A
SIDE B CLV	Extended-play disc side B
1/L	First soundtrack/left channel
2/R	Second soundtrack/right channel
DIGITAL	Digital sound
ANALOG	Analog sound
MOVIE	Surround mode

* Discs not indicating time data to the second indicate instead as two-digit numbers such as "0.22".

** Some discs do not contain Side A or B identification coding. In that case, disc side indications may not be accurate.

Reading the Front Panel Display

The illustration to the right is an example of what is displayed on the front panel of the player.

Finding Out Play Status

When playing an LD containing TOC (Table of Contents) data, the AV Calendar shows information on the total number of selections on the disc or those programmed to play. As selections are played, the corresponding numbers on the display disappear.

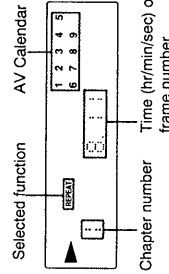

* When playing a multiplex LD (see page 13) such as a bilingual movie disc, the player automatically outputs the left channel sound. To listen to the other channel sound, press the **AUDIO MONITOR** button to alternate sound.

How to Search Using Variable Speed Play (for CAV discs)

Remote Only

To find a scene, play the disc back or forward at varying speeds.* Use Multi Speed and Speed Set for CAV standard-play LDs. Use the Shuttle Ring, which lets you scan gradually, for all discs.

To Change Speed and Direction (Multi Speed)

- 1 Press **MULTI SPEED** on the Remote to select the direction.

To reverse <
To advance >
- 2 Press **SPEED SET** on the Remote to select the speed.

To reduce speed -
To increase speed +
(You can press SPEED SET first, or do either step without the other.)
- 3 Press **DISPLAY**.

The play speed and direction appear on screen.

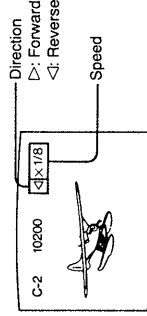

Normal playback resumes.

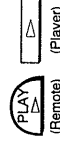

- 4 Press **PLAY** (▶).

Discs with Automatic Picture Stop Code

When an automatic picture stop code (found on educational discs) is encountered during variable speed play, the player automatically stops at that frame. To resume playback, press **PLAY**, **MULTI SPEED**, or turn the Shuttle Ring.

Extended-Play (CLV) or Non-CAV Discs

Variable Speed Play, Freeze Frame, and Step Play are not possible with CLV discs. When a **MULTI SPEED** button is pressed, the screen goes blank and the message "SIDE A (or "B") CLV" appears.

To Change Speed and Direction Gradually (Variable Speed Scan)**

Rotate the Shuttle Ring on the Remote in the forward or reverse direction.

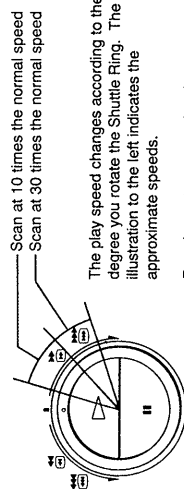

The play speed changes according to the degree you rotate the Shuttle Ring. The illustration to the left indicates the approximate speeds.

Pressing ◀◀ or ▶▶ on the player, you can scan scenes at a invariable speed.

To Resume Normal Play Release the Shuttle Ring.

* A certain amount of visual noise and instability is inevitable with all variable speed operations.
 ** Scanning speed varies as the laser beam moves away from the center of a CLV disc.

How to Search by Chapter Numbers

LDs are divided into sections called "chapters". Chapters are usually listed on the jacket or label of the disc. By entering the desired chapter number, you can have the player find the chapter and play it. Use **ACS/AMS**—Automatic Chapter Sensing/Automatic Music Sensing—to advance or reverse a chapter at a time.

To Locate a Particular Chapter

Press one of the number keys on the Remote or front panel corresponding to the chapter you want to play.

For example, to locate chapter 8, press "8" on the Remote or front panel.

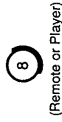

The player starts searching for Chapter 8.

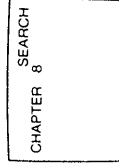

The player finds Chapter 8 and starts playing from the beginning of Chapter 8.

Press +10 and one of the number keys.

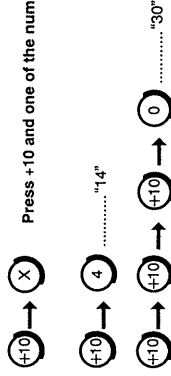

To Enter a Number Greater Than 10*

Do this to make a numerical sum. For example, to enter 14, press +10 and 4; to enter 30, press +10, +10, +10 and 0. You can select up to 15 directly by pressing the number keys on the front panel of the player.

To Check the Current Chapter Number



If you make a mistake while entering numbers, press +10 repeatedly until 0 is displayed, then enter the correct numbers.

Press **DISPLAY** on the Remote to display the chapter number (upper left-hand corner) on screen. You can also look at the AV Calendar on the front panel display for the chapters on the disc left to be played.

To Advance or Go Back a Chapter at a Time (Skip Search)



Press **ACS/AMS** (◀) on the Remote once to return to the beginning of the current chapter. Press **ACS/AMS** (▶) to advance to the beginning of the next chapter.

Press **ACS/AMS** (◀) twice before the picture reappears to return to the beginning of the previous chapter.

Press the **ACS/AMS** button repeatedly for continuous skip search.

The player automatically resumes play from the beginning of the selected chapter.

To Resume Normal Play**

How to Search by Frame Number or Time—Frame/Time Search

Remote Only

Video scenes are counted as a series of still pictures or "frames". The player keeps track of the number of frames that have been played from the beginning of the disc to the current position. Similarly, the player also keeps track of the elapsed playing time from the beginning of the disc. To play from a particular frame or time, use the Frame/Time Search function.

On CAV (standard-play) discs, enter a frame number. On CLV (extended-play) discs, enter the time.*

To Enter the Elapsed Frame or Time

- 1 Press the **FRAME/TIME** button on the Remote.



The screen displays "00000" (for CAVs) or "0:00:00" (for CLVs).

CAV
(standard-play) disc

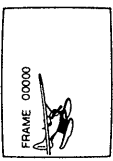

CLV
(extended-play) disc

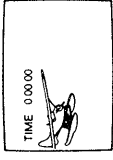
- 2 Enter the desired multi-digit number corresponding to the frame or time you want found.**

Enter five digits for CAVs
Enter five digits for CLVs displaying the time to the second.
Enter three digits for CLVs displaying the time to the minute.

4 → ... → 1 → 2 → 3 → 4 → 0

1 → 2 → 0 → 5

Sample Entry for CAV Discs

To locate frame number 12340, press the number keys in the order on the right:

Sample Entry for CLV Discs

To locate the 12-minute, 5-second point, press the number keys in the order on the right:

If you make a mistake, press **FRAME/TIME** again to return the display to zero, and then enter the correct numbers.

Play starts from the time or frame specified in step 2.

To Check the Frame/Time Numbers

The current frame or current time numbers appear on screen when you press **DISPLAY** on the Remote. You can also find them on front panel display.

Before pressing the **SEARCH/NEXT** button, press **CLEAR** on the Remote. If you have already pressed the **SEARCH/NEXT** button, press **STOP** (■).

To Cancel Frame/Time Search

In addition to play mode, you can conduct Frame/Time Search while in Freeze-Frame, Variable Speed Play, Repeat or Pause mode. When the specified frame or time appears after the search, play continues in the same mode.

- * "CAV" or "CLV" should be noted somewhere on the disc jacket.
- ** If you enter a frame or time number not contained on the disc, the player plays the very last part of the disc then stop, or it does not accept your entering.

24 To Play a Laser Disc

How to Play Frame-by-Frame (for CAV discs)

Remote Only

Once you have found a particular scene, you can examine the progression of that scene by advancing or reversing the action one frame at a time (Step Play), or freezing the action into a still picture (Freeze Frame).*

To Play One Frame at a Time (Step Play)



- 1 Press **PAUSE (II)** once.



The frame freezes.
- 2 Press **STILL/STEP** on the Remote repeatedly.



Each press shifts the image one frame backward or forward.

To reverse

To advance

Hold down the button for continuous frame-by-frame action.

In addition to pause mode, you can achieve Step Play while the player is in play mode by pressing one of the **STILL/STEP** buttons while the disc is playing.

To Freeze the Action (Freeze Frame)

- Press **PAUSE (II)** once.
- 

To Resume Normal Play

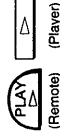
- Press **PAUSE (II)** again, or Press **PLAY (▶)**.
- 

Extended-Play (CLV) Discs

Freeze Frame and Step Play are not possible with CLV discs. When the **PAUSE** button is pressed, the screen goes blank and the message "SIDE A (or B) CLV" appears.

How to Continue Play from the Point You Stopped at — Memory Play

Remote Only

This function can only be used for LDs, and in the continuous play mode**. Even if you use the **STOP** (■) button to stop, you can still continue play from the point you stopped at.

To Play Again from the Point You Stopped at

- Press **MEMORY PLAY** on the Remote while in the stop mode.
- 
- The player starts searching for the point you stopped at.

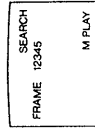

Play starts at the point you stopped.

If you turn off the power, press **MEMORY PLAY** before you turn on the power. The player will turn on automatically and continue playing again from the point you stopped at. (If the power is turned on first, this function cannot be performed. The player will start playing from the very beginning of the disc.)

* This function can only be performed on CAV discs.
** You cannot use this function in the shuffle, program and single repeat play. If you press **▶◀▶▶** / **▶▶▶** or **◀** while in the stop mode, this function is canceled.

To Play a Laser Disc 25

How to Repeat the Same LD Selections

Remote Only

These instructions show you how to program the player to play the same scenes over and over until you signal the repetition to stop. You can replay a single side, a single chapter or a section between one pair of points on the disc.

To Repeat the Entire Side of the Disc

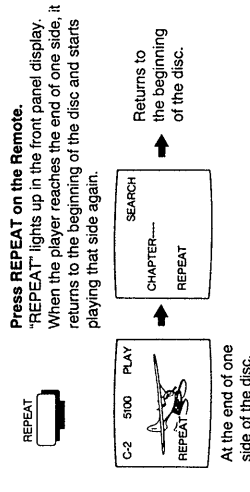

To Repeat the Current Chapter

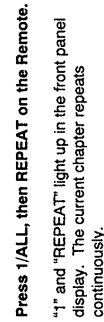

To Cancel REPEAT

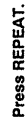

To Cancel REPEAT-1/ALL



To Repeat One Section of the Disc

- Go back to the start of the scene you want replayed. This marks where replay is to begin.
- Press **REPEAT A--B** at the beginning of where you want replay to begin. The "REPEAT" and "A" indication lights up, and "B" indication in the front panel flashes.
- Let the player run to the end of the scene you want repeated.
- Press **REPEAT A--B** again. This marks where replay is to end.

To Cancel REPEAT A--B



Press **CLEAR**.

"REPEAT A B" lights up in the front panel display. The player repeatedly plays the same scene between the two points selected.

How to Play Only Certain Chapters—Programmed Play

You can choose, in any order you like, the chapters the Multi Disc Player plays. This play list is stored in the player until you either remove the disc or turn off the power. After playing all the selections, the player stops and waits for your next command.

1 Press PGM/RESERVE.

"PGM" flashes in the front panel display.
"PROGRAM -- --" appears on screen.

2 Press one of the number keys.

Press numbers for all the chapters you want played.
For example, press 5, 4, 2, and 6 to play those chapters in that order.

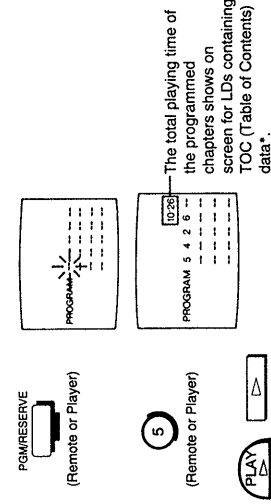

3 Press PLAY (▶).

To Start Over



To Change an Entry

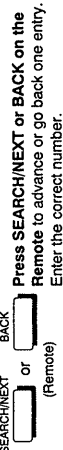

To Enter a Number Greater Than 10

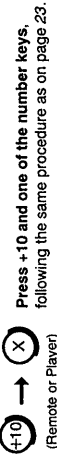

To Cancel Programmed Play



To Replay the Programmed Chapters



To Advance or Go Back a Chapter**



To Check the Contents of the Program

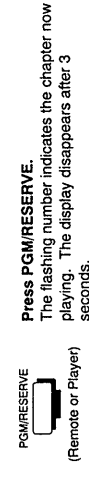

- * If you enter 0 or chapter numbers greater than 21, or if total play time exceeds 100 minutes, the total play time is not displayed.
- ** The player does not go back to previous chapters if the Shuttle Fling is rotated to the left, although, it does advance to forward chapters if rotated to the right. To go back to preceding chapters, press the ACS/AMS (◀) button repeatedly.

To Play a Compact Disc

This section explains how to perform procedures associated with playing CDs.

In this manual, **Remote Only** indicates that the functions explained in the section are available only with the Remote Commander (Remote).

How to Load and Play a CD (Compact Disc)

After you have connected the Multi Disc Player to the stereo system, you can begin playing a compact disc.

- 1 Set the **INPUT SELECTOR** to **MAIN**, the **MODE selector** to **NORMAL**.

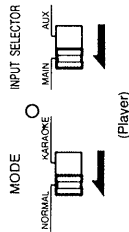

- 2 Turn on the stereo system.

Turn on the amplifier or receiver and select CD, AUX, or other desired audio input.

- 3 Turn on the multi disc player.

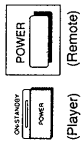

Press the **POWER** button on the player or Remote Commander (the Remote).

- 4 Open the disc tray.

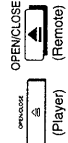

Press the **OPEN/CLOSE** button on the player or Remote.

- 5 Place a disc on the tray.

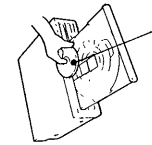

Carefully center a single CD on the tray. If you insert more than one disc, or the disc is not seated properly, it may not play or damage the unit and/or the disc.

What is this indication?



This indication appears in the front panel display when the tray is empty.

- 6 Start playback.



Press **PLAY**.

To Advance or Reverse

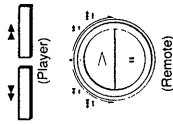

Hold down the **Advance/Reverse** button on the player or rotate the **Shuttle Ring** on the Remote.

To Advance or Go Back One Track at a Time



Press the **ACS/AMS** button on the Remote.

To Interrupt Play

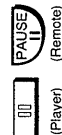

Press **PAUSE**. To resume playback, press **PAUSE** or **PLAY**.

To Stop Playback

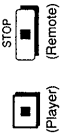

Press **STOP**. To play again from the beginning, press **PLAY**.

To Stop Play and Remove the Disc



Press **OPEN/CLOSE**. Remove the CD and close the empty tray.

To Have the Player Pause Before Starting

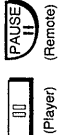

Press the **PAUSE** button on the player or the Remote instead of pressing **PLAY**. The tray closes and the player waits at the start of the disc until you press **PAUSE** or **PLAY**.

To Activate Playback with an Optional Timer

Set the timer with the **AC power** connected to the player. When the timer supplies power at the preset time, the player starts playing the disc. If there is no disc in the player, the player turns off automatically.

To Play a Stereo CD or a Second Audio Program (SAP) CD

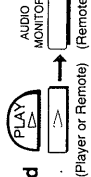

Press **PLAY**, then press the **AUDIO MONITOR** button on the Remote.

The procedure below indicates how the output and the display change with each press. The active track will appear on the TV screen for three seconds and then disappear.

Procedure	Display	Output Sound	
		Stereo Disc	SAP Disc
1 Press PLAY .	No message	Stereo (Both channels)	Soundtrack 1 (left channel) Soundtrack 2 (right channel)
2 Press AUDIO MONITOR .	1/L	Left channel	Soundtrack 1 (left channel)
3 Press AUDIO MONITOR again.	2/R	Right channel	Soundtrack 2 (right channel)
4 Press AUDIO MONITOR again to return to stereo status.	1/L 2/R	Stereo (Both channels)	Soundtrack 1 (left channel) Soundtrack 2 (right channel)

Understanding Displays and Messages When Playing CDs

Remote Only

You can determine player operating status or disc information in one of two ways: (1) by displaying the information on the TV screen, or (2) by looking at the front panel display.

To View On-Screen Information



Turn on the television, and press **DISPLAY** on the Remote.
To turn off the display, press **DISPLAY** again.

Reading the On-Screen Messages

The illustration below is an example of what is displayed. The table is a key to the messages that appear on the right.

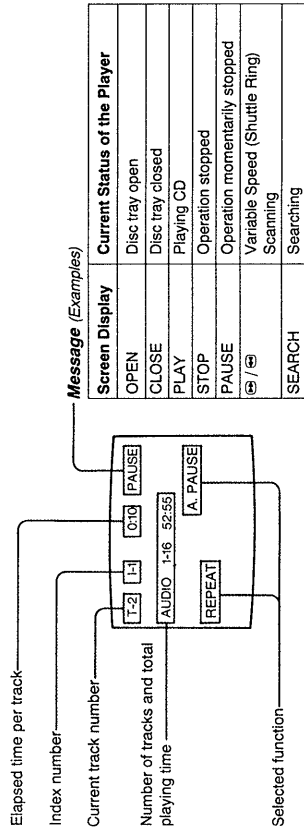

Reading the Front Panel Display

The illustration to the right is an example of what is displayed on the front panel of the player.

Finding Out Play Status

When playing a CD, the AV Calendar shows information on the total number of tracks on the disc or those programmed to play. As tracks are played, the corresponding numbers on the display disappear.

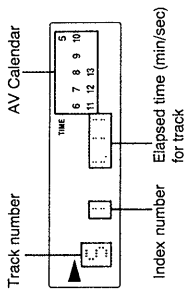

How to Locate a Certain Track

CDs are divided into sections called "tracks". To find a point within a track, use the Shuttle Ring. To find and play from the beginning of a certain track, use the number keys. In addition, use the ACS/AMS buttons to advance or reverse one track at a time.

To Find a Certain Point on the Disc

Rotate the Shuttle Ring on the Remote in the forward or reverse direction.

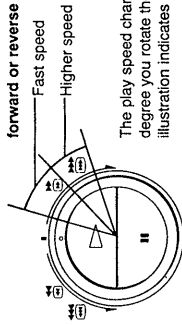

The play speed changes according to the degree you rotate the Shuttle Ring. The illustration indicates the speed levels.

Pressing ◀ or ▶ on the player, you can scan scenes at a invariable speed.

Press one of the number keys on the Remote or front panel to enter the track number you want played.



To Locate a Particular Track

Press +10 and one of the number keys.

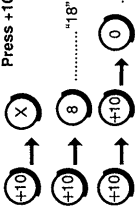

Do this to make a numerical sum. For example, to enter 18, press +10 and 8; to enter 20, press +10, +10 and 0. You can select up to 15 directly by pressing the number keys on the front panel of the player.

If you make a mistake while entering a numbers, press +10 repeatedly until 0 is displayed, then enter the correct number.

To Check the Current Track Number

See the AV Calendar on the front panel display.

To Advance or Go Back One Track at a Time



Press ACS/AMS (◀) on the Remote once to return to the beginning of the current track. Press it again before the selection starts to return to the beginning of the previous track.

Press ACS/AMS (▶) to advance to the beginning of the next track.

Press the ACS/AMS button repeatedly to advance or go back.

To Play a Single Track Once



- 1 Press the 1/ALL button on the Remote.
 - 2 Enter the track number you want played.
- "1" is displayed on the front panel display.
- When the track has been played, the player stops. To cancel the setting, press 1/ALL again.
- If you press the wrong number keys, simply press the correct ones.

How to Replay the Same CD Selections

Remote Only

You can program the player to play the same scenes over and over until you signal the repetition to stop. You can replay the entire disc, a single track, or a section between one pair of points on the disc.

To Repeat the Entire the Disc . . .



Press REPEAT on the Remote.

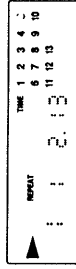

"REPEAT" lights up in front panel display. The player plays all tracks on the CD. When the player reaches the end of the disc, it plays again.

To Repeat the Current Track

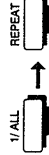

Press 1/ALL on the Remote Commander; then, press REPEAT.

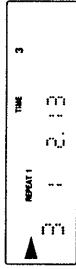

"REPEAT" and "1" light up in front panel display. The current track repeats continuously.

To Cancel REPEAT



Press REPEAT. "REPEAT" disappears.

To Cancel 1/ALL-REPEAT

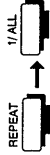

Press REPEAT and 1/ALL, or CLEAR on the Remote.

To Repeat One Section of the Disc

- Go back to the start of the section you want replayed.
- Press REPEAT A↔B to mark the beginning of the section.
- Let the player run to the end of the section you want repeated.
- Press REPEAT A↔B again to mark the end of the section.



The "REPEAT" and "A" indication lights up, and "B" indication begins flashing in the front panel.



"REPEAT A B" lights up in the front panel display. The player repeatedly plays the selection between the two selected points.

To Cancel REPEAT A↔B



Press CLEAR.

How to Play Only Certain Tracks—Programmed Play

You can program, in any order you like, the tracks the Multi Disc Player plays. This play list is stored in the player until you either remove the disc or turn off the power. Program up to 20 tracks. After playing all the selections, the player stops and waits for your next command.

1 Press PGM/RESERVE on the Remote.



"PGM" flashes in the front panel display.



2 Press one of the number keys.



Press numbers for all the tracks you want played. For example, press 5, 4, 6 and 2 to play those tracks.

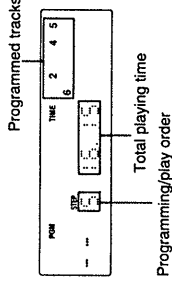

The total playing time of the programmed tracks is displayed on the front panel display.*

3 Press PLAY (▶).

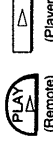

To Start Over

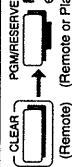

Press CLEAR and PGM/RESERVE. Then, enter the correct track numbers.

To Change an Entry



Press SEARCH/NEXT or BACK on the Remote to advance or go back one entry. Enter the new number.

To Enter a Number Greater Than 10



Press +10 and one of the number keys following the same procedure as on page 31.

To Cancel Programmed Play



Press CLEAR or 1/ALL on the Remote. The player resumes normal playback.

To Replay the Same Programmed Tracks

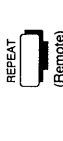

Press REPEAT on the Remote. "REPEAT" is displayed in the front panel.

To Advance or Go Back**



Press ACS/AMS (◀◀ or ▶▶) on the Remote. The player moves to the preceding or following programmed tracks.

To Check the Contents of the Program

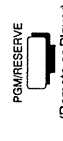

Press PGM/RESERVE. The flashing number indicates the chapter now playing. The display disappears after 3 seconds.

* If 0 or track numbers greater than 21 are entered, the total play time is not displayed.
 ** The player does not go back to previous tracks if the Shuttle Ring is rotated to the left, although, it does advance to forward tracks if rotated to the right. To go back to preceding tracks, press the ACS/AMS (◀◀) button repeatedly.

To Play a Compact Disc Video

This section explains basic procedures for playing CDVs and VSDs. Since CDV and VSD play holds so many functions in common with CD and LD play, see other sections of this manual for details of applicable functions mentioned here.

How to Load and Play a CDV (Compact Disc Video) or VSD (Video Single Disc)

CDVs are divided into two sections: video and audio. The video section of the disc consists of 5 minutes of video play with digital audio output. The audio section consists of 20 minutes of solely digital audio output (playable on any CD player). Thus, the CDV has the function of both an LD and CD combined in one disc. The audio and the video sections of the CDV are assigned track numbers. The track on the video section corresponds to the chapter on the LD and the same on the CD.



1 Turn on the TV, stereo system (if connected), and Multi Disc Player.

2 Place a disc on the tray.

3 Press PLAY (▶).

Play begins from the video section. To start play from the audio section, using the number keys, enter the track number that starts the audio section.

OPEN/CLOSE



To Stop and Remove the Disc



To Advance or Go Back a Track at a Time



To Interrupt Play



To Find a Certain Audio or Video Track



To Play Certain Video Tracks

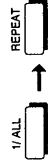

To Repeat the Current Track

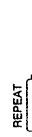

To Repeat All Selections



To Repeat a Section of the Disc



To Variable Speed Play (Audio and Video)

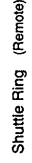

To Display Remaining Playback Time

Understanding Displays and Messages When Playing CDVs or VSDs

Remote Only

You can determine player operating status or CDV information in one of two ways: (1) by displaying the information on the TV screen, or (2) by looking at the front panel display.



To View On-Screen Information

Reading the On-Screen Messages

The screen below is an example of what is displayed. The table below is a key to the messages that appear on the screen.

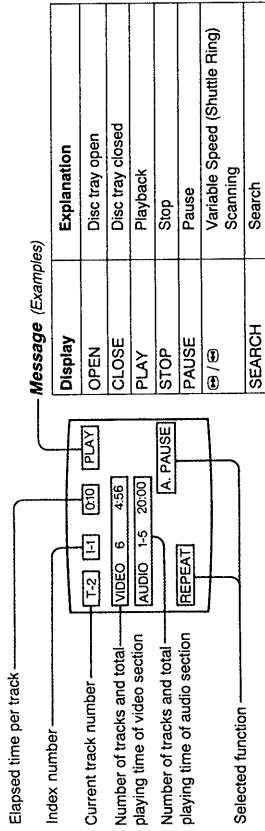

To Display Remaining Playback Time



Press AV TIME on the Remote. See "How to Display the Elapsed Playing Time - Time Counter" on page 37.

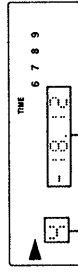

Finding Out Play Status

When playing a CDV, the AV Calendar on the front panel display shows information on the total number of selections. As selections are played, the corresponding numbers on the display disappear.

To Play Any Disc (Advanced Functions for LD, CD, or CDV Play)

This section explains advanced functions apply to any one of the three types of discs.

How to Have the Disc to Play Within a Period of Time

Remote Only

You can program the disc to play within a specified period of time. This is called "Auto Program Playback". Decide how long you want the disc to play and then enter half that amount of time. The player divides the selections you designate onto what it calls "Program A" and "Program B", playing both A and B for the amount of time entered. The player pauses between the two programs. The following procedure explains how to conduct Auto Program Playback on a CD, but you can also use the function for LDs and CDVs with TOC. (Auto Program does not function on LDs that do not contain TOC data.)

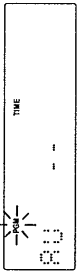
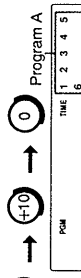
- 1 Press **AUTO PGM** on the Remote. "PGM" flashes in the front panel display.
 
- 2 Enter the desired play time. Using the number keys, enter the time. For example, to enter 30 minutes, press +10 three times and 0.*
 

(Remote or Player)

If you press the wrong number, simply press the correct one.

Program A and Program B appear alternately in the AV Calendar displays the contents of the two different programs: Program A and B, separated by a pause.

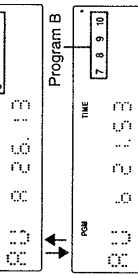

If you designate a play time shorter than the length of the disc, some selections on the disc may not fit into the time span given and therefore may not play. On the other hand, if you designate a play time longer than the length of the disc, the whole program of selections may run on Program A, with none running on Program B. This is because Program A always has priority over B.

Example for a Forty-Minute Disc

Let's say your disc is 40 minutes long (see table below) and you designate playing time to run 15 minutes. Program A will run for 15 minutes (or less) and Program B will also run for 15 minutes (or less) for a total of about 30 minutes of play (see table below).

Auto Program Examples for a 40-Minute Disc

You enter	Program A plays	Program B plays	Total play time
15	15 min (or less)	15 min (or less)	30 min (or less)
30	30 min (or less)	10 min (about)	40 min
45	40 min (all selections)	0 min	40 min

- 3 Press **PLAY** (▶).
 

Program A selections start playing. The player pauses and waits for you to press **PLAY** again for Program B.

- 4 Press **PLAY** (▶) again to play Program B.
 

To Resume Normal Play from Auto Program

Press **CLEAR** or **1/ALL** on the Remote.



* If your disc contains more than 20 track or chapter numbers, the ones beyond 20 may not run.

How to Display the Elapsed Playing Time — Time Counter

Remote Only

You can display elapsed time information on the front panel display or TV screen. How the information is displayed depends on the type of disc being played.

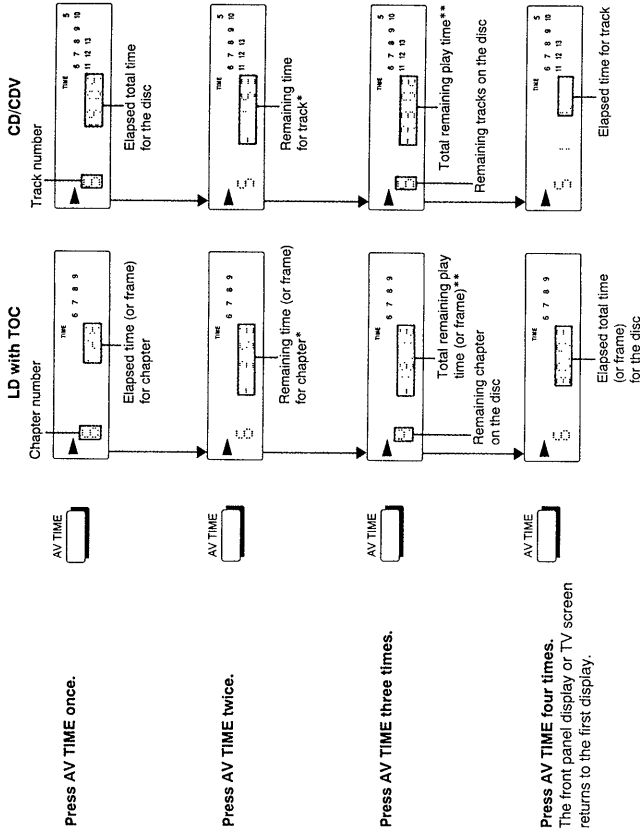

Press **AV TIME** once.

Press **AV TIME** twice.

Press **AV TIME** three times.

Press **AV TIME** four times. The front panel display or TV screen returns to the first display.

The Time Counter Display Depends on the Kind of Disc

CDs or CDVs

The time appears on the front panel display or TV screen.

LDs with TOC

The display shows the number of elapsed frames or elapsed time.

CDs and LDs with TOC

When you press the **STOP** (■) button, the display shows total tracks and total play time.

CDVs

The display shows the total number of tracks and total play time for the audio and video section alternately.

* The display does not show remaining play time for selection numbers above 21.

** When playing CDVs, these figures refer only to the current section (audio or video) being displayed.

How to Program the Player to Pause or Scan Automatically

There are many functions you can program the Multi Disc Player to do automatically. Two of them are Auto Pause and Intro Scan. To make the player stop every time a selection ends, use Auto Pause. When you want to find a particular track, use the INTRO button to make the player play the first 8 seconds (approximately) of each chapter or track on the CD, LD, or CDV.

To Make the Player Stop Momentarily (Auto Pause)

Press AUTO PAUSE on the Remote once.
To play the next selection, press PLAY (▶).

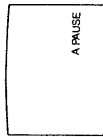

Press AUTO PAUSE again.



To Resume Normal Playback

To Scan the Beginning of Each Chapter/Track (Intro Scan)

Press INTRO on the Remote.
The player plays only the first 8 seconds (introduction) of each chapter or track on the disc. After the player introduces the last chapter, the player pauses. On CDVs, intro-scanning resumes from the video section of the disc.



Press the PLAY (▶) button.
Play resumes from the selection just introduced.



Press the STOP (■) button.

To Resume Normal Play

To Stop Play

How to Play Selections in Random Order—Shuffle Play

Remote Only

Shuffle Play is another of the Multi Disc Player's programmable functions. As the name implies, this function allows you to play all the tracks or chapters on a disc in random order, once or repeatedly. From this random order you may program the player to delete tracks or chapters you don't want played. (Note that Shuffle Play can only be conducted on LDs, CDs and CDVs containing TOC data.)

To Ensure Correct Operation

Before you press the SHUFFLE button, make sure the disc tray has closed completely, and the "▶" (Play) indication in the front panel display has stopped flashing.

To Shuffle Play all Tracks or Chapters on a Disc

- 1 Press SHUFFLE on the Remote.



"SHUFFLE" flashes in the front panel display.

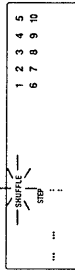

- 2 Press PLAY (▶).



All the selections on the disc play once in random order. After all the selections play, the player stops. CDV selections play randomly from the both audio and video parts of the disc.

To Advance to the Next Selection

Press the ACS/AMS (▶▶) button on the Remote to skip to the next track or chapter.
(The ACS/AMS (◀◀) button does not function to return to a previous track or chapter in Shuffle Play mode.) Or, use the Shuffle Ring.



Press CLEAR or 1/ALL on the Remote.
This clears Shuffle Play. Playback resumes from the next selection.

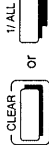

To Delete Certain Selections from Shuffle Play

- 1 Press SHUFFLE.
- 2 Enter the chapter or track number of the selection you do not want the player to play.
- 3 Press PLAY (▶).

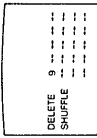

The player automatically plays a random program of selections without the ones you deleted.

To Clear an Entry

- 1 Press CLEAR.
- 2 Press SHUFFLE.
- 3 Enter the correct numbers.



(continued)

Shuffle Play (continued)

To Change an Entered Number

- 1 Press **SEARCH/NEXT** (to advance) or **BACK** (to go back) on the Remote until the number you want to change flashes on the front panel display.

- 2 Using the number buttons, enter the correct number.
(Remote or Player)

To Repeat Shuffle Play



Press the **REPEAT** button on the Remote. This activates the **REPEAT** indication in the front panel display. The player reshuffles the selections and plays them back in a different random order.

To Clear Shuffle Play



Press **CLEAR** or **1/ALL**. When you turn off the player, or you remove the disc, all shuffle functions clear from the memory of the player.

How to Use the Surround Effect

Choose from three acoustic effects for enhanced listening quality. These are identical to the effects in the **KARAOKE** mode.

Press the **SURROUND** button on the Remote or front panel of the player.

The surround mode changes with each press of the **SURROUND** button. The **SURROUND** indicator for the mode selected on the player will light up. The **SURROUND** mode will also appear on the TV screen for three seconds.

- Here is what each surround mode offers:
- SIMULATED** : Good for playing software recorded in monoaural. Enhances the dynamic range for monoaural programs like old movies and news programs.
 - KARAOKE BAR** : Creates the effect of singing in a bar.
 - MOVIE** : Gives your song a rich carrying tone. Suitable for movie software. Emphasizes the bass and extends the dynamic mid range.
 - SURROUND OFF** : Cancels the surround effect.

To select the **SURROUND OFF**, make all the indicators go out.

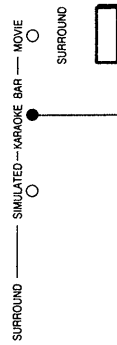

The indicator on the front panel is lit for the mode selected.

SECTION 2 DISASSEMBLY

Note: Follow the disassembly procedure in the numerical order given.

2-1. TRAY COVER

- 1 Turn power on, push  (OPEN/CLOSE) button and then the tray comes out.

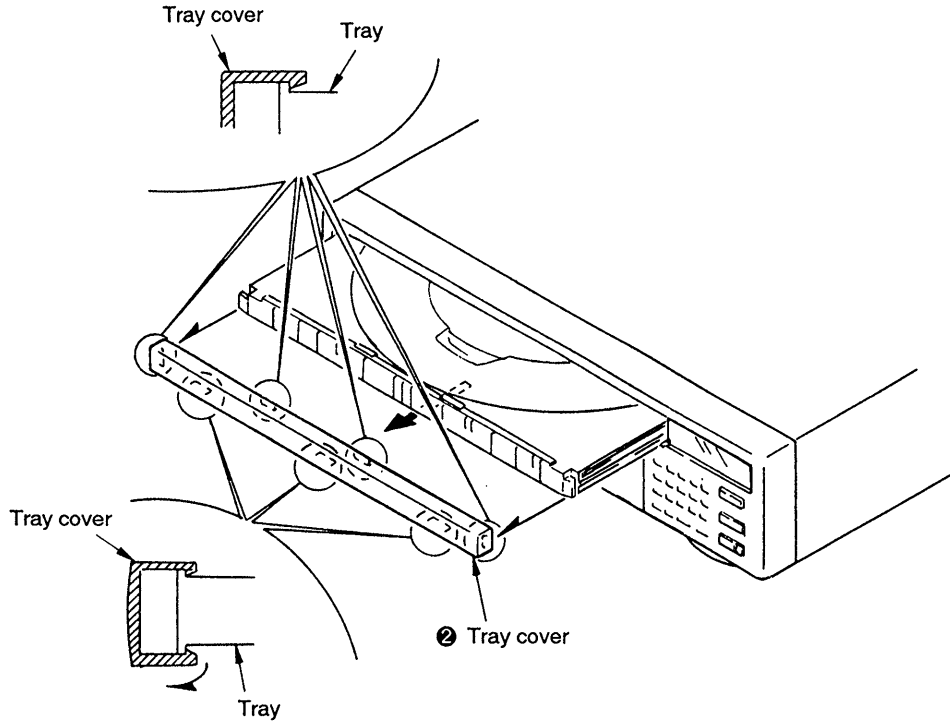

2-2. UPPER CASE, FRONT PANEL ASSEMBLY

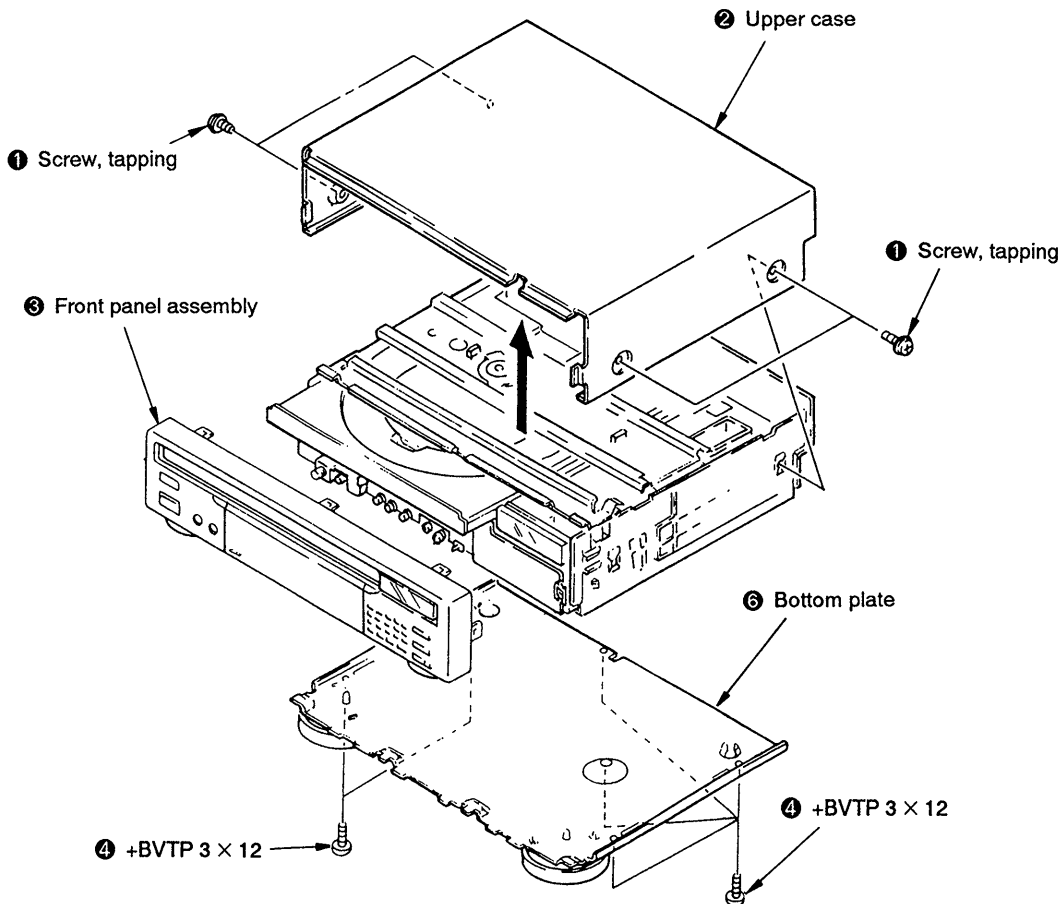

2-3. MB-701 BOARD

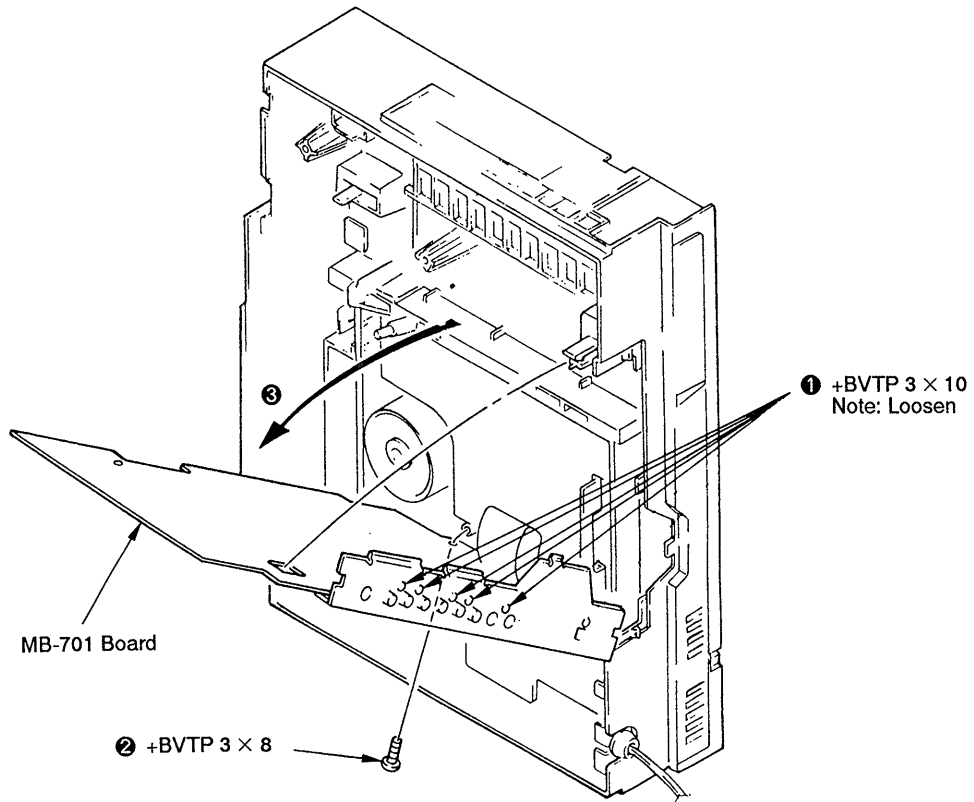

2-4. MD CHASSIS, OPTICAL DEVICE CHASSIS

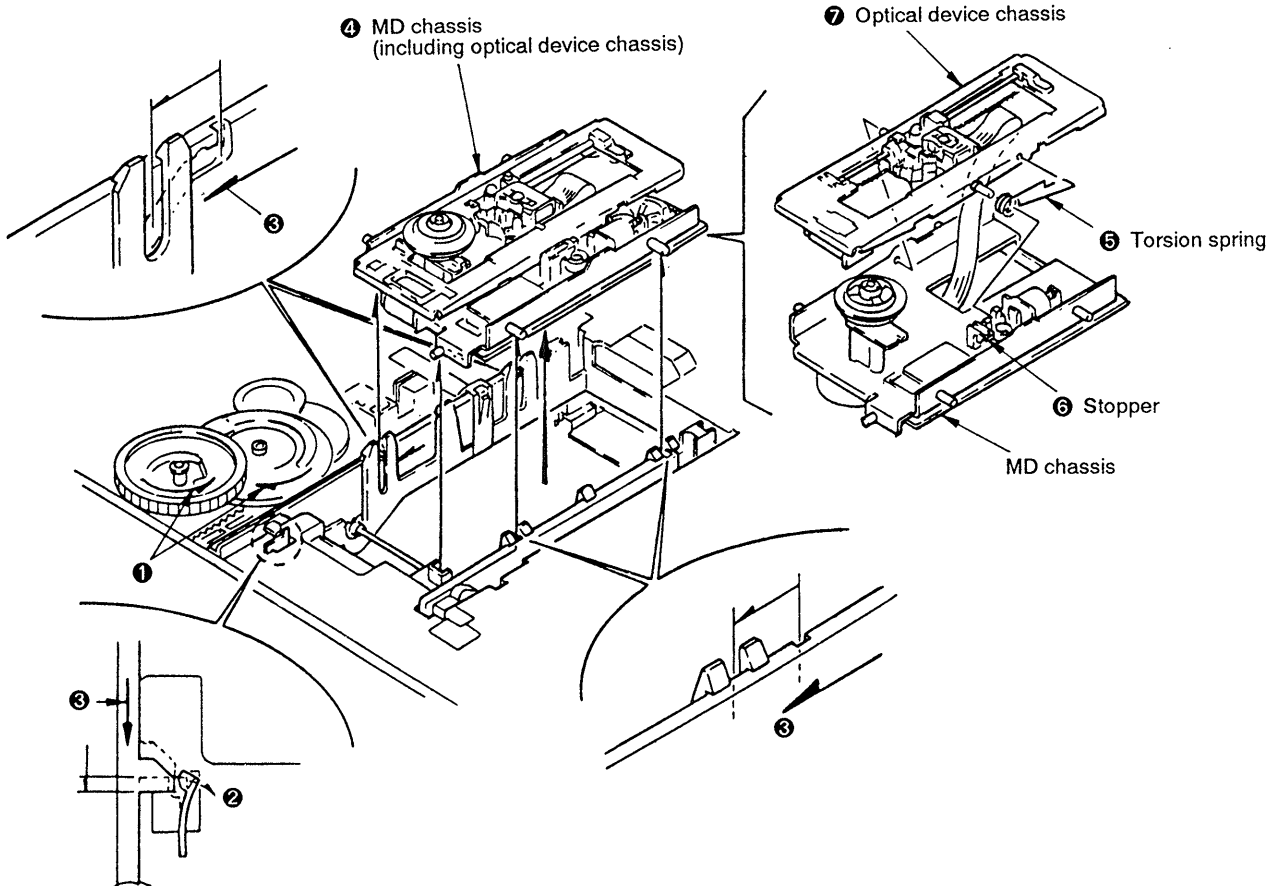

2-5. TURNTABLE, SPINDLE MOTOR, SKEW MOTOR, SV-63, FG-41 BOARDS

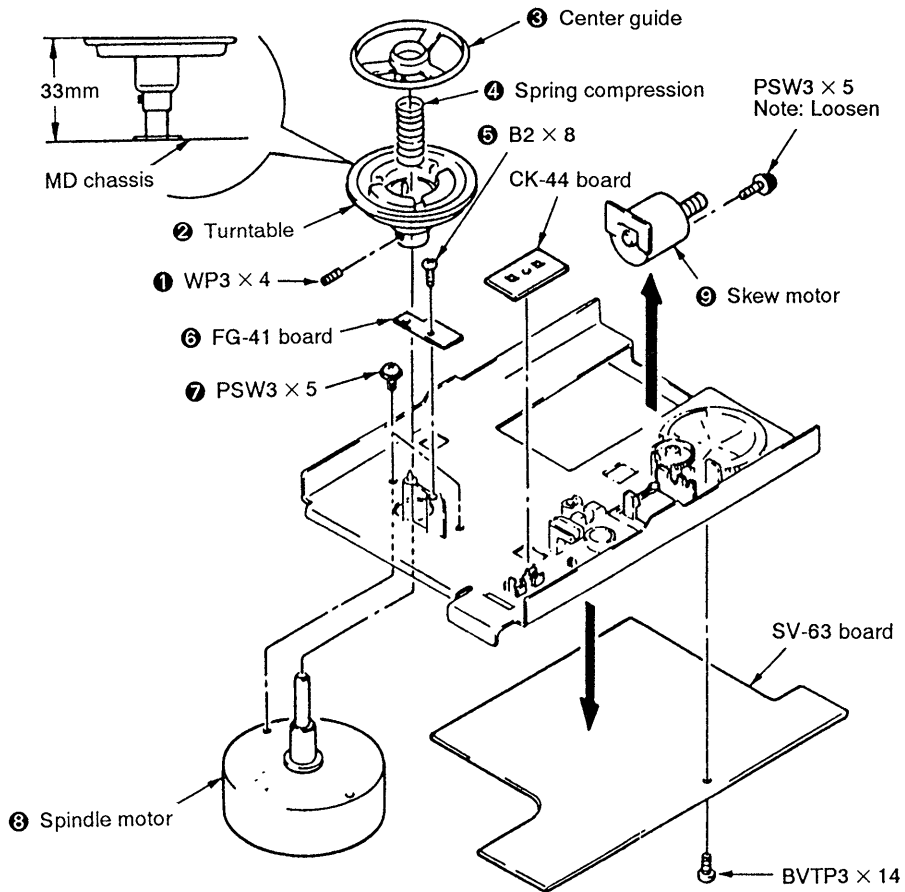

2-6. REMOVAL OF THE TRAY

Note Make sure to remove the tray after having removed the front panel and the front reinforcement plate.

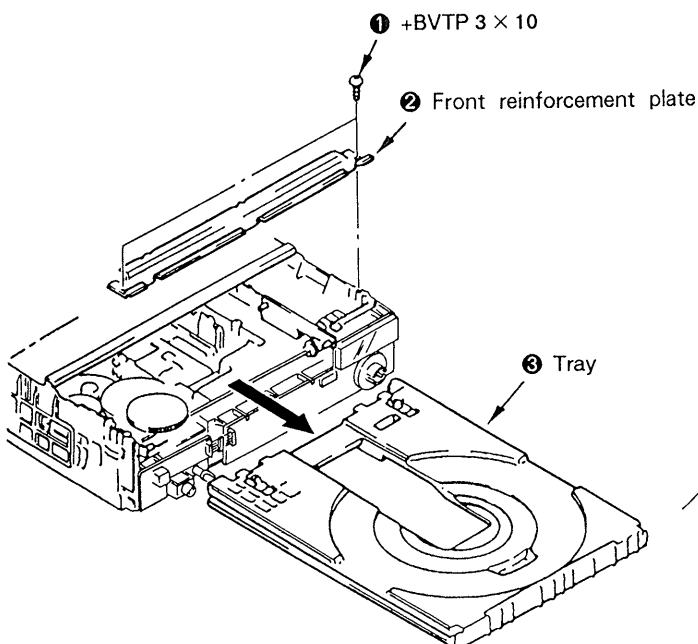

2-7. REMOVAL OF THE DISC WHEN A PROBLEM HAS OCCURRED WITH THE DISC LOADED.

- 1) Turn the pulley (A) in counter-clockwise direction until the tray starts moving.
- 2) Pull out the tray.

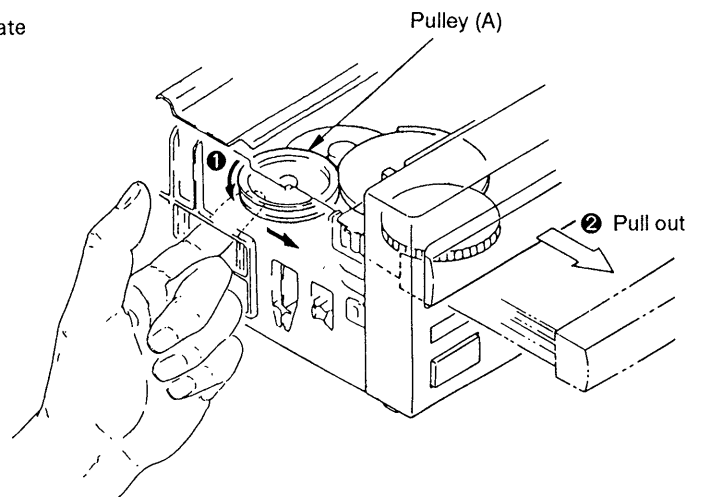

2-8. ALIGNMENT OF THE LOADING GEAR PHASE

- 1) Install the drive cam as shown in the illustration.
At this time, make sure that the last tooth of gear is aligned with the line from the center of the tray gear axle and the drive gear axle.
- 2) Install the tray gear as shown in the illustration.
At this time, make sure the flat surface of the cam is at a right angle with the drive cam.

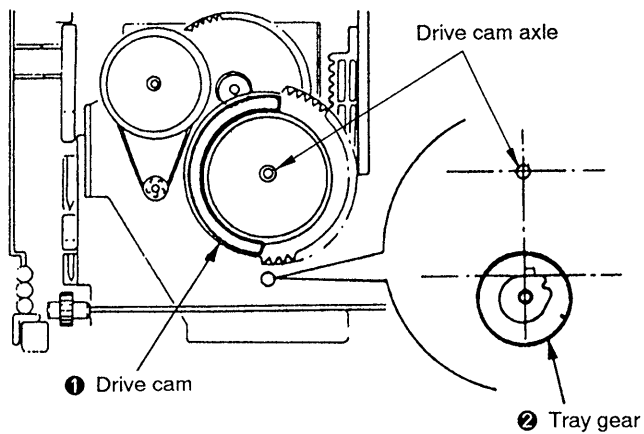

SECTION 3 DIAGRAMS

3-1. CIRCUIT BOARDS LOCATION

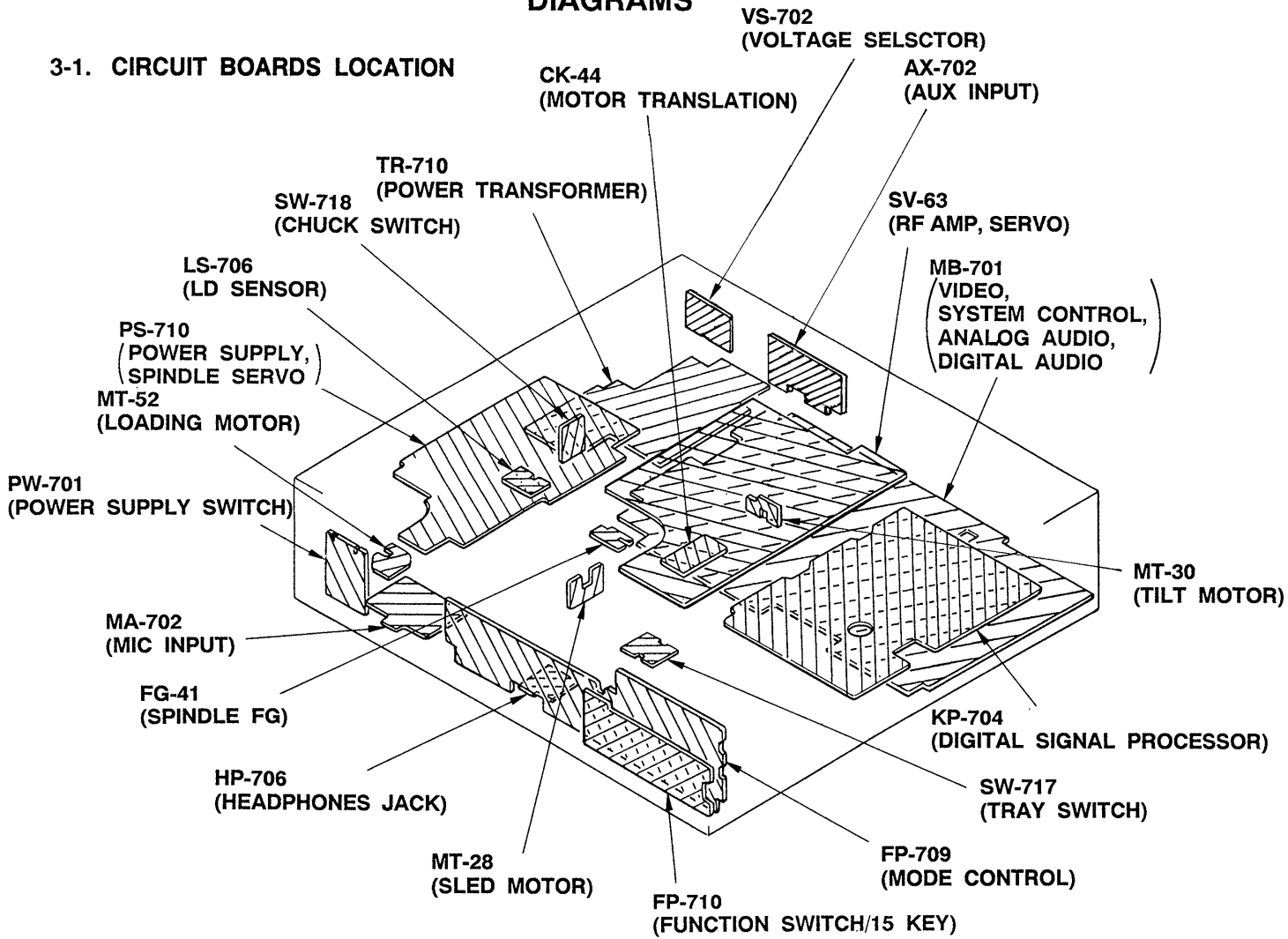

• MAIN PARTS LOCATION

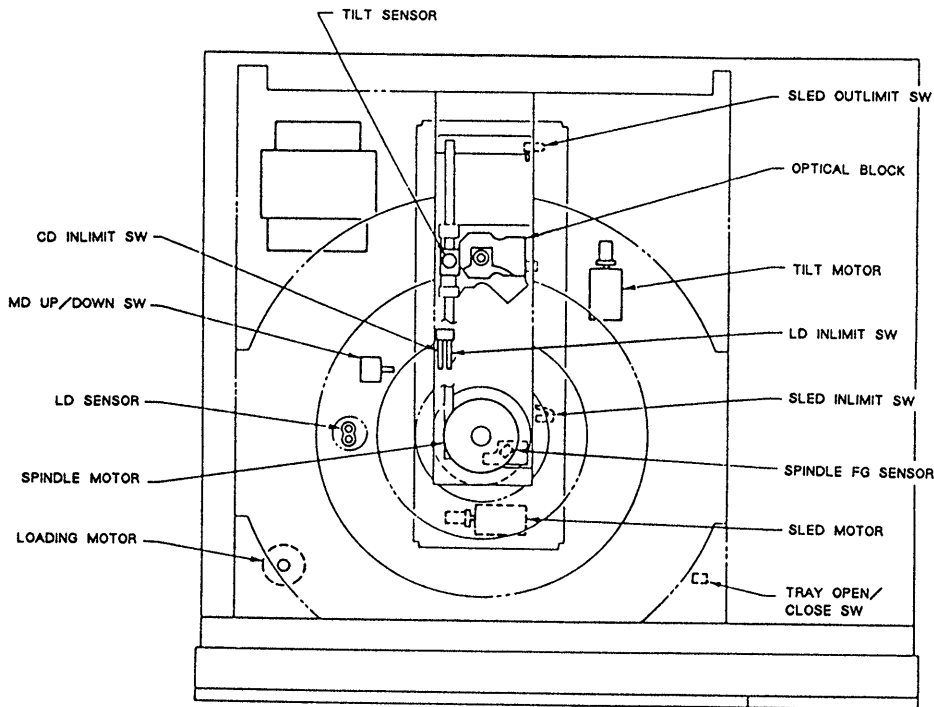

3-2. OVERALL BLOCK DIAGRAM

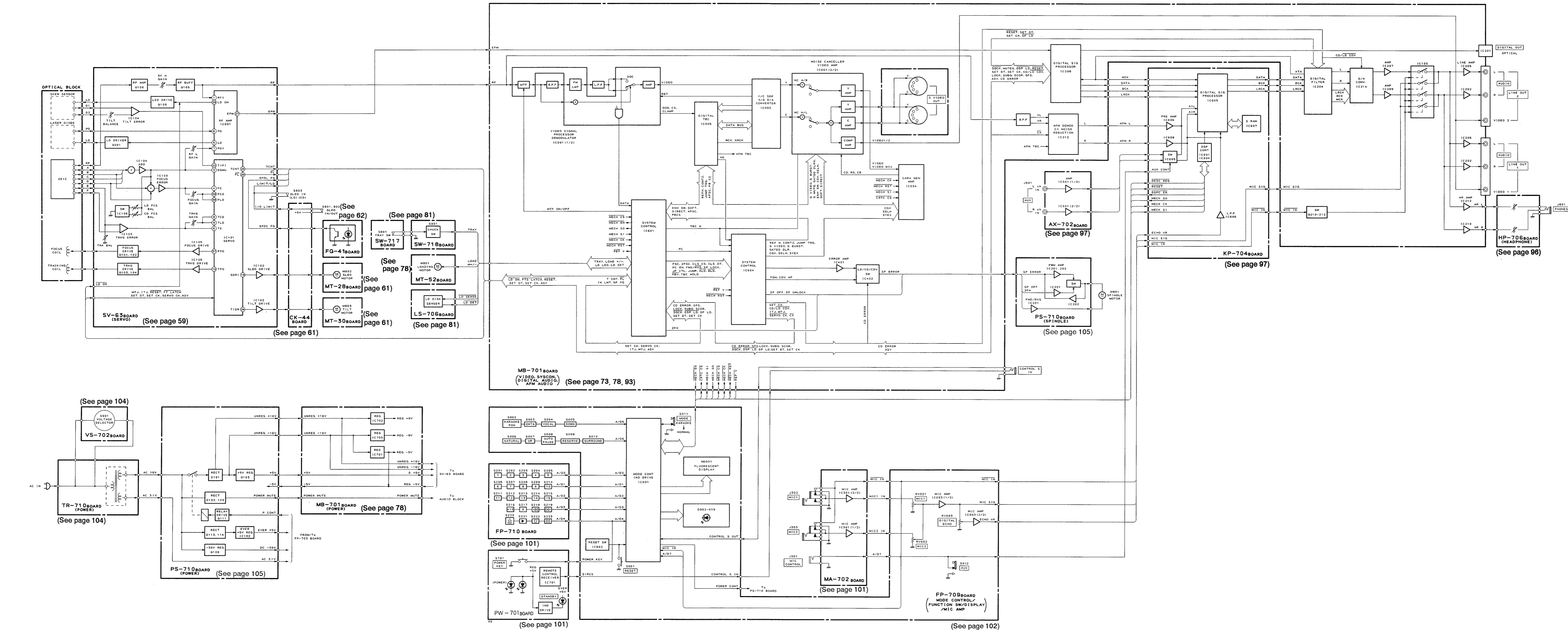

3-3. RF AMP, SERVO BLOCK DIAGRAM

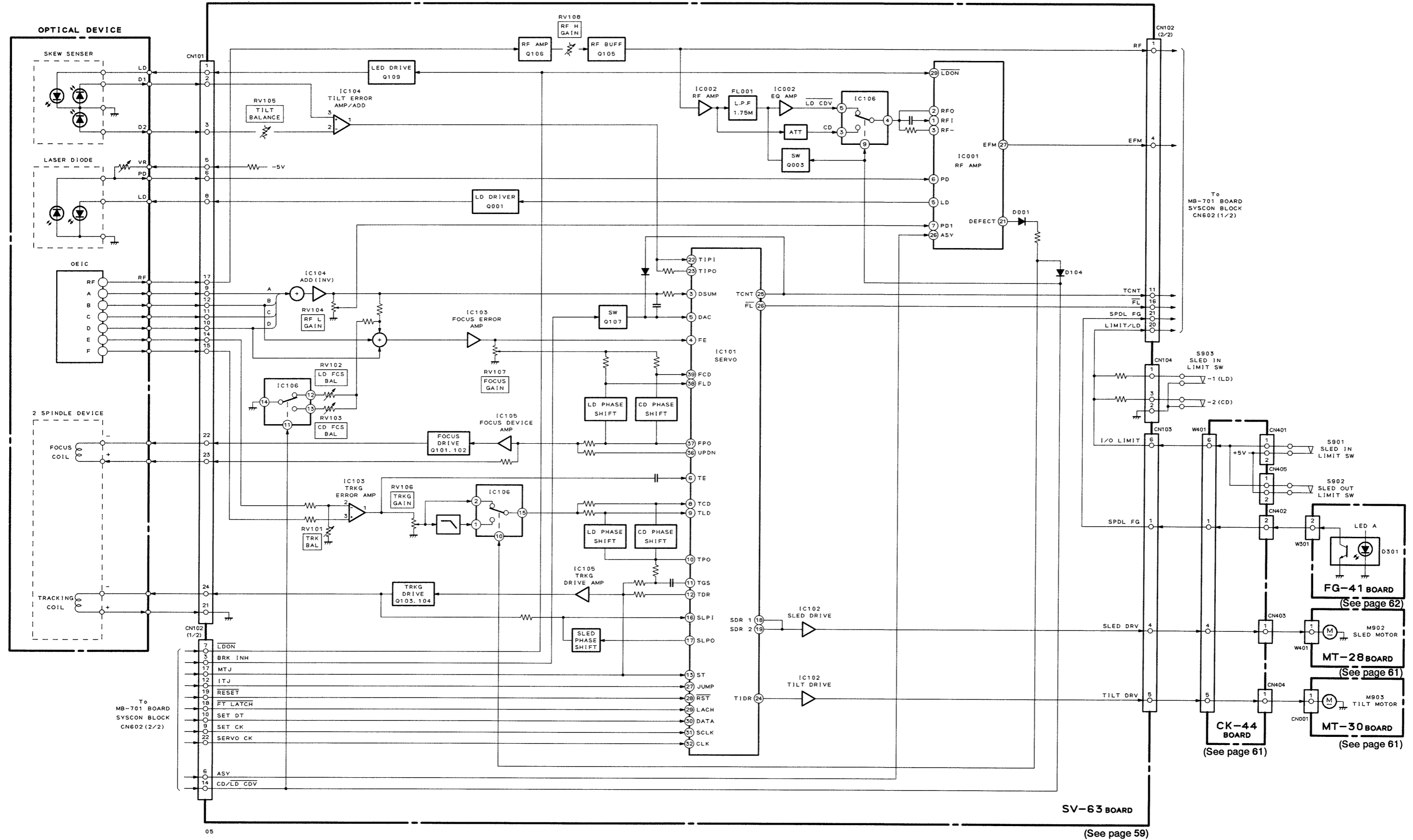

3-4. SYSTEM CONTROL BLOCK DIAGRAM

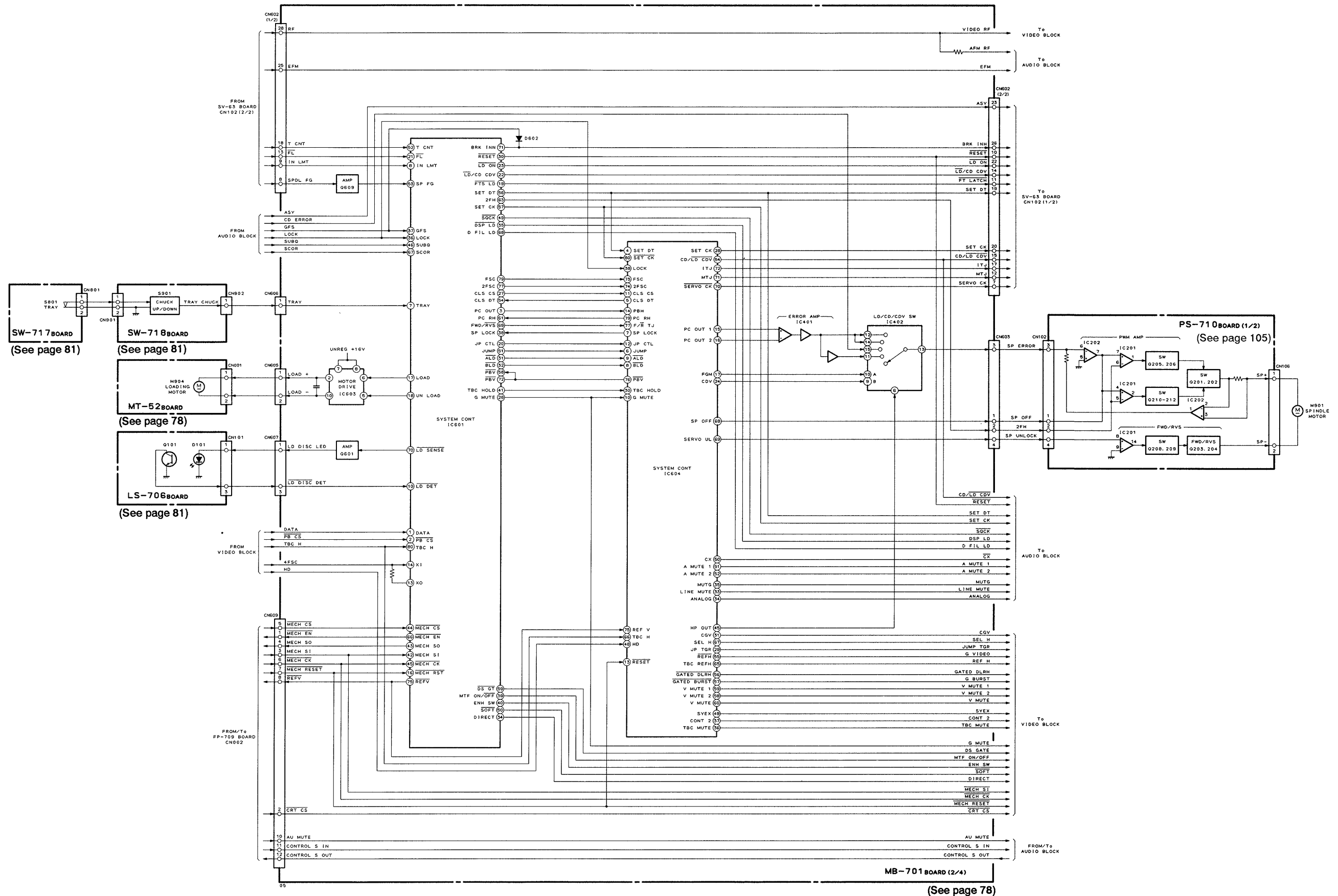

3-5. SYSTEM CONTROL MICROCOMPUTER PIN FUNCTIONS (MB-701 BOARD IC601 MB89795)

No.	Signal Name	I/O	Function	
1	DATA	I	Data (Philips code) input	
2	PBCS	I	Playback composite video sync. signal	
3	PC OUT	O	Playback H sync. signal output	
4	AVCC	—	A/D converter power supply	
5	AVR	—	A/D converter reference voltage	
6	AVSS	—	A/D converter ground	
7	TRAY	I	Tray loading switch voltage	
8	IN LIMIT	I	Sled position switch voltage	
9	MIRR	I	Not used	
10	LD DET	I	LD disc detection	
11	—	—	Not used	
12	MOD	I	Microcomputer internal/external ROM select	
13	XO	O	Clock input 14.31818 MHz	
14	XI	I	Clock output 14.31818 MHz	
15	VSS	—	Digital ground	
16	RST	I	Reset	
17	LOAD	O	Loading motor control (IC603)	
18	UNLOAD	O		
19	FTSLD	O	Servo IC (SV-63 board IC101) data load signal	
20	JPCTL	O	Track jump control (ITJ/MTJ)	
21	FL	I	Focus servo lock signal	
22	LD/CD CDV	O	Disc judgement signal	
23	LD ON	O	Optical pick-up laser diode emitting control	
24	WRQ	—	Not used	
25	MEMO			
26	FLO			
27	CLS CS	O	ENABLE signal for CLS CS (IC604 ⑩) signal	
28	G MUTE	O	Gray screen muting control on clear scan	
29	SOLA 2	—	Not used	
30	RESET	O	Reset control	
31	ALD	O	IC604 output port (register A, B) data load signal	
32	BLD	O		
33	—	—	Not used	
34	DIRECT	O	Enhancer control signal	
35	DSPLD	O	Data load signal to DSP	
36	LOCK	I	RF PLL lock signal	LOCK is made up of sampling GFS
37	GFS	I	RF PLL lock signal	
38	SP LOCK	I	Spindle servo lock signal	
39	MTF ON	O	MTF control signal	
40	ENH. SW	O	Enhancer control signal	

No.	Signal Name	I/O	Function
41	TBC HOLD	O	TBC HOLD control signal
42	MECH SI	I	Communicating data from mode control microcomputer (FP-709 IC001)
43	MECH SO	O	Communicating data to mode control microcomputer
44	$\overline{\text{MECH CS}}$	I	Chip select signal from mode control microcomputer
45	$\overline{\text{MECH CK}}$	I	Clock from mode control microcomputer
46	SUB Q	I	SUB Q data from DSP
47	—	—	Not used
48	—	—	
49	$\overline{\text{SQCK}}$	O	Serial data clock to DSP
50	$\overline{\text{SOFT}}$	O	Enhancer control signal
51	JMP	O	Track jump trigger signal
52	TCNT	I	Pulse for traverse counting
53	SP FG	I	Spindle FG pulse
54	CLS DT	I	CLV clear scan V sync. counter data
55	VCC	—	Power supply (+5 V)
56	SET DT	O	External IC communicating data
57	SET CK	O	External IC communicating clock
58	$\overline{\text{PB V}}$	I	Playback V sync. signal
59	$\overline{\text{DS GT}}$	O	Philips code reading out control signal
60	—	—	Not used
61	PCRH	I	Reference H sync. signal for spindle servo
62	REFH	O	Not used
63	2FH	O	Spindle motor driver PWM carrier
64	$\overline{\text{TEST}}$	I	Test mode control
65	TV/DISC	O	RF modulator TV/Disc select signal
66	$\overline{\text{MECH EN}}$	O	Communication control signal to mode control microcomputer (FP-709 IC001)
67	SCOR	I	SUB code sync. signal
68	DFIL LD	O	Digital filter data load signal
69	$\overline{\text{FWD/RVS}}$	O	Multi track jump direction control
70	$\overline{\text{LD SENSE}}$	O	LD disc sensor control pulse
71	BRK INH	O	Servo IC (SV-63 board IC101) track jump control
72	PB V	O	Playback V sync. signal
73	—	—	Not used
74	—	—	
75	REF V	O	Reference V sync. signal
76	—	—	Not used
77	FSC2	O	2fsc (7.519 MHz) output
78	DOCI	O	Not used
79	FSC	O	fsc (3.579545 MHz \pm 10 MHz) output
80	TBCH	I	TBC output H sync. signal

3-6. VIDEO BLOCK DIAGRAM

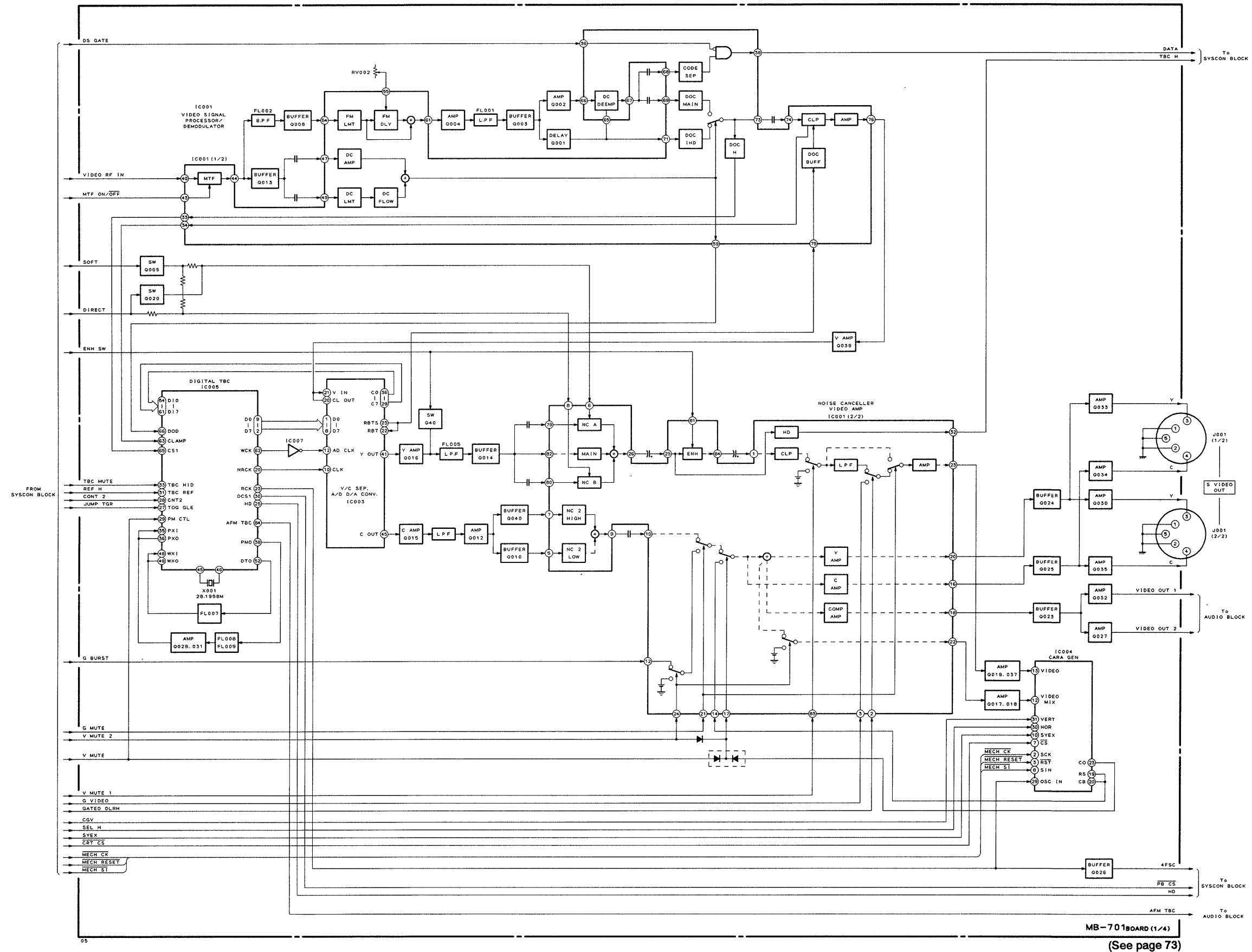

3-7. DIGITAL SIGNAL PROCESSOR, AFM AUDIO BLOCK DIAGRAM

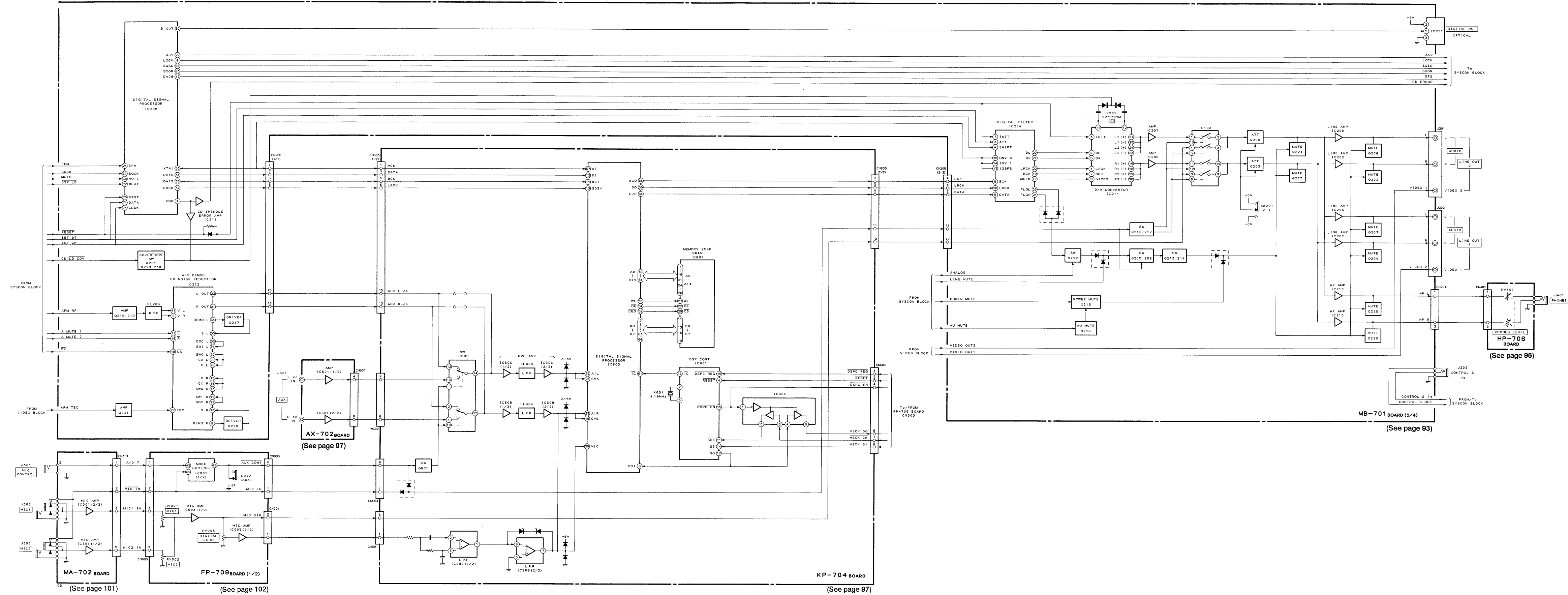

**3-8. DIGITAL SIGNAL PROCESSOR MICROCOMPUTER PIN FUNCTION
(KP-704 BOARD IC603 CXP5084)**

No.	Pin Name	Signal	I/O	Function
1	VL		O	N. C.
2	XTAL	XTAL	I	Clock
3	EXTAL	EXTAL		
4	$\overline{\text{RST}}$	$\overline{\text{RESET}}$	I	Reset
5	WP		I	+5 V
6	INT1		I	DSP data transfer request from external circuit
7	PY0		O	N. C.
8	PY1			
9	PY2		I	+5 V
10	PY3			
11	$\overline{\text{SC}}$	$\overline{\text{SCK}}$	I/O	Communicating clock
12	SOB	SO	O	Data to DSP
13	SOA		O	N. C.
14	SI	SI	I	Data from mode control
15	PD0	$\overline{\text{DSPCEN}}$	O	Communication enable signal to mode control
16	PD1	$\overline{\text{IC}}$		Reset to DSP
17	PD2	$\overline{\text{DSPCS}}$		Data transfer CS to DSP
18	PD3			N. C.
19	PC0	$\overline{\text{DSPCREQ}}$	I	Communication request from mode control
20	PC1			+5 V
21	PC2			
22	PC3			
23	PB0		O	N. C.
24	PB1			
25	PB2			
26	PB3			
27	PA0		O	N. C.
28	PA1			
29	PA2			
30	PA3			
31	PESEAL			N. C.
32	VSS	GND		Ground
33 – 60	PE0 – COM0		O	N. C.
61 – 63	VLC1 – VLC3		I	+5 V
64	VDD	VDD	I	Power supply

**3-9. MODE CONTROL MICROCOMPUTER PIN FUNCTIONS
(FP-709 BOARD IC001 CXP50116-409Q)**

No.	Pin Name	Signal	I/O	Function
1	S4/PG0		—	Surround mode LED OFF: 0
2	S5/PG1	SIMU	—	
3	S6/PG2	KARAOKE	—	
4	S7/PG3	MOVIE	—	
5	S8/PK0	P12	O	FDP segment output
6	S9/PK1	P11	O	
7	S10/PK2	P10	O	
8	S11/PK3	P9	O	
9	S12/PJ10	P8	O	
10	S13/PJ1	P7	O	
11	S14/PJ2	P6	O	
12	S15/PJ3	P5	O	
13	S16/T15	P4	O	
14	S17/T14	P3	O	
15	S18/T13	P2	O	
16	S19/T12	P1	O	
17	S20/T11		—	Not used
18	S21/T10		—	
19	S22/T9	10G	O	FDP timing output
20	S23/T8	9G	O	
21	T7	8G	O	
22	T6	7G	O	
23	T5	6G	O	
24	T4	5G	O	
25	T3	4G	O	
26	T2	3G	O	
27	T1	2G	O	
28	T0	1G	O	
29	INT	REF-V	I	Reference V sync. signal
30	TX		O	Not used
31	TEX		I	
32	RST	RST	I	Reset
33	N. C		—	Not used
34	VDD	VDD	—	Power supply
35	PI0/AD0	AD0	I	Key input
36	PI1/AD1	AD1	I	
37	PI2/AD2	AD2	I	
38	PI3/AD3	AD3	I	
39	PB0/AD4	AD4	I	
40	PB2/AD5	AD5	I	
41	PB3/AD6	AD6	I	
42	PB3/AD7	AD7	I	
43	EC	EC	—	+5 V
44	PX0/SC	MECH CK	O	Clock for communication to mechanism control, DSP control, character graphic ICs.
45	PXI/SO	MECH SO	O	Communicating data to mechanism control, DSP control, character graphic ICs.
46	PX2/SI	MECH SI	I	Communicating data from mechanism control, DSP control, character graphic ICs.

No.	Pin Name	Signal	I/O	Function
47	PA0	$\overline{\text{MECH CS}}$	O	Chip select signal to mechanism control ICs.
48	PA1	$\overline{\text{CRTC CS}}$	O	Chip select signal to character graphic IC.
49	PA2	$\overline{\text{MECH EN}}$	I	Receiving completion signal from mechanism control IC.
50	PA3	$\overline{\text{MECH RST}}$	O	Reset signal to mechanism control, DSP control ICs.
51	PF0	$\overline{\text{DIGITAL}}$	O	0: Digital sound LED
52	PF1	$\overline{\text{K. PON}}$	O	Sound mode LED OFF: 1
53	PF2	$\overline{\text{ONTA}}$	O	
54	PF3	$\overline{\text{VOCAL}}$	O	
55	PE0	DOWN	O	Key control level LED
56	PE1	NATURAL (O)	O	Not Karaoke mode: Off OFF: 1
57	PE2	POWER CONT	O	Power supply control output
58	PE3	A MUTE	O	Audio mute output
59	PY0		O	Not used
60	PY1/PWM	$\overline{\text{DSPCREQ}}$	O	Communication request to DSP controller
61	PY2/WP	WP	I	+5 V
62	PY3/RMC	SIRCS IN	I	SIRCS input
63	PD0	$\overline{\text{DSPCON}}$	I	Communication enable signal from DSP controller
64	PD1	$\overline{\text{MIC IN}}$	I	0: Mic in
65	PD2	J/UC	I	1: CG Japanese 0: CG English
66	PD3	KP1/KP2	I	Not used
67	PC0	KARAOKE	I	0: Karaoke mode
68	PC1	$\overline{\text{AUXCONT}}$	I	0: Audio AUX input
69	PC2	TEST	I	0: Test mode
70	PC3	GND	—	GND
71	VSS	GND	—	GND
72	XTAL	XTAL	I	Clock input
73	N. C		—	Not used
74	EXTAL	EXTAL	O	Clock output
75	VREF	VDD	I	Power supply
76	VFDP	VFDP	I	Power supply for FDP (– 30 V)
77	S0/PH0	UP	O	Key control level OFF: 0
78	S1/PH1	AUTOPAUSE	O	1: Auto pause OFF: 0
79	S2/PH2	RESERVE	O	1: Reserve OFF: 0
80	S3/PH3		O	Not used

3-10. MODE CONTROL AD KEY

AD Port	Level				
	Low ←				→ High
AD0 ㉕	1	2	3	4	5
AD1 ㉖	6	7	8	9	10
AD2 ㉗	11	12	13	14	15
AD3 ㉘	—	+10	0	◀◀	▶▶
AD4 ㉙	▲	▶	■		POWER ON/OFF
AD5 ㉚	KARAOKE PON	ONTA DIRECT	VOCAL	b	—
AD6 ㉛	h	#	AUTO PAUSE	RESERVE	SURROUND
AD7 ㉜	—	#	h	b	◀◀

3-11. MODE CONTROL BLOCK DIAGRAM

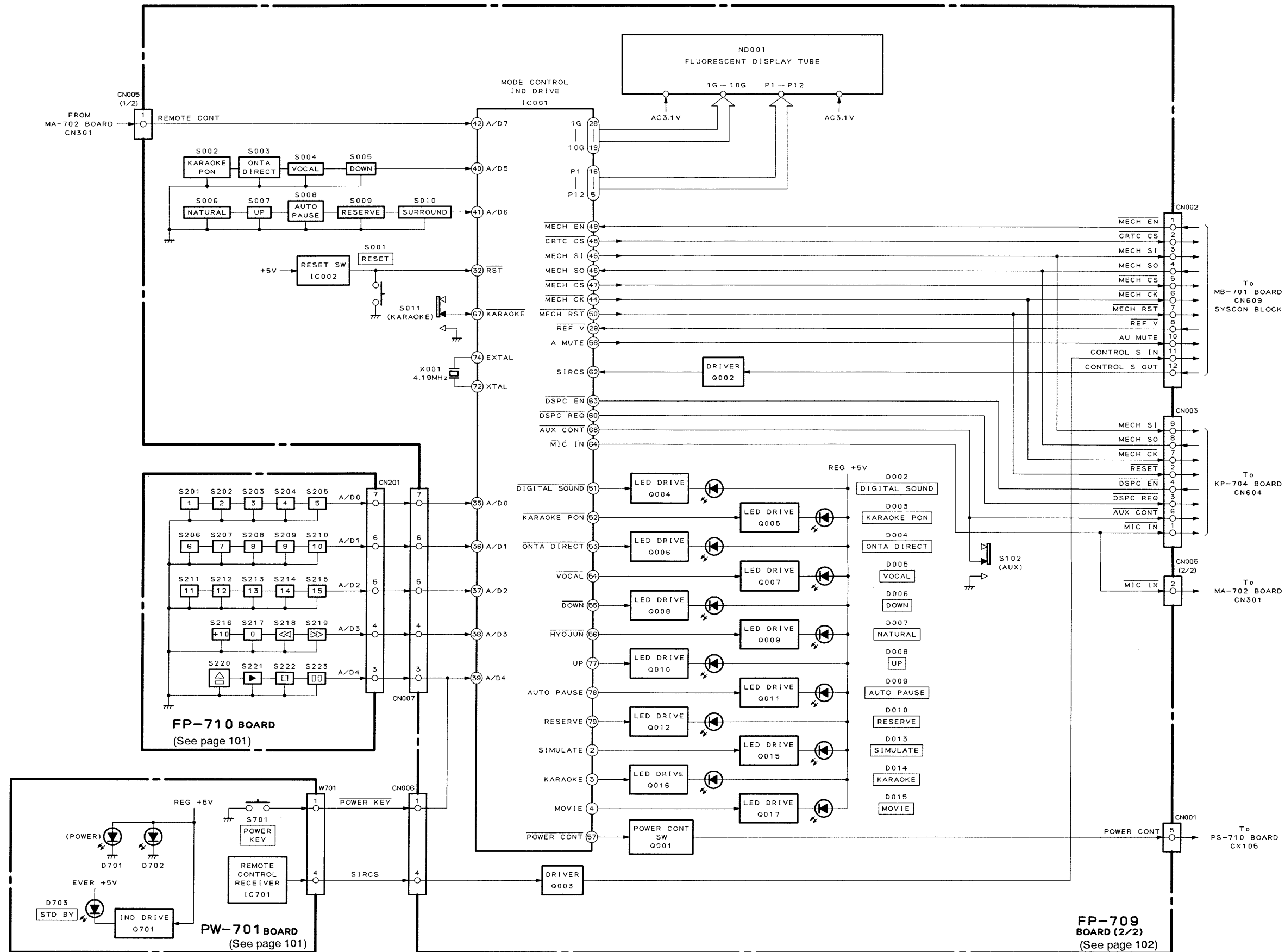

05

3-12. POWER BLOCK DIAGRAM

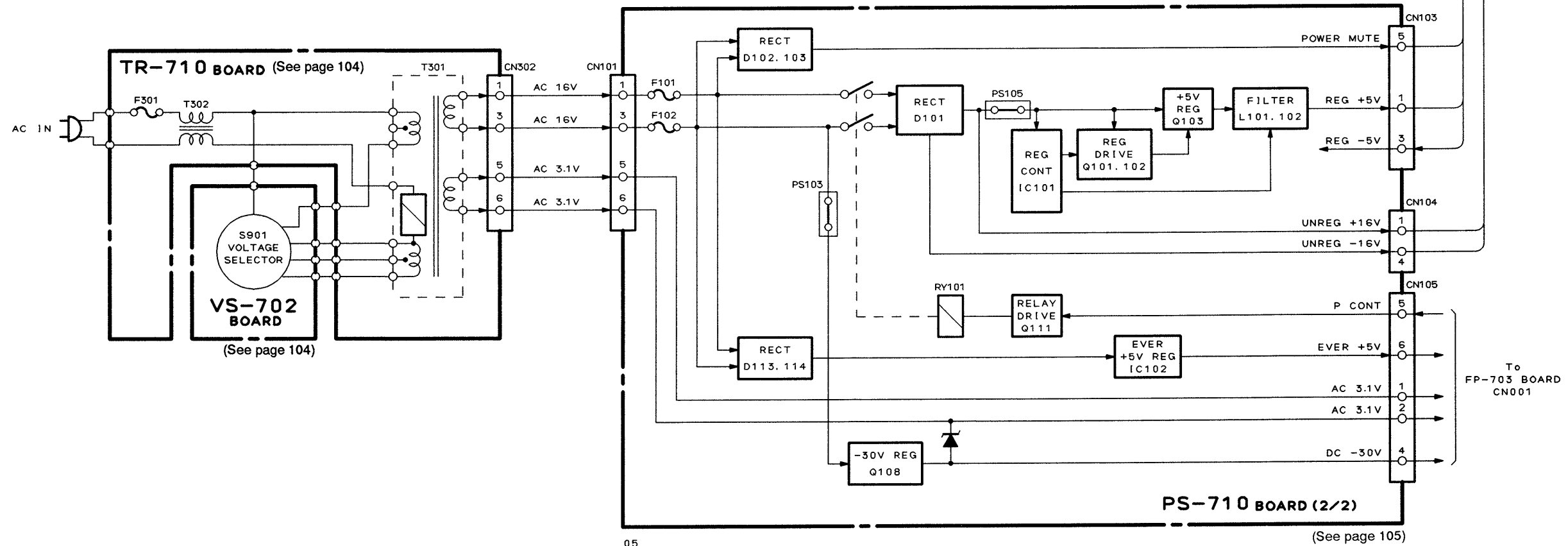

05

SECTION 4
 PRINTED WIRING BOARDS AND SCHEMATIC DIAGRAMS
 4-1. FRAME SCHEMATIC DIAGRAM

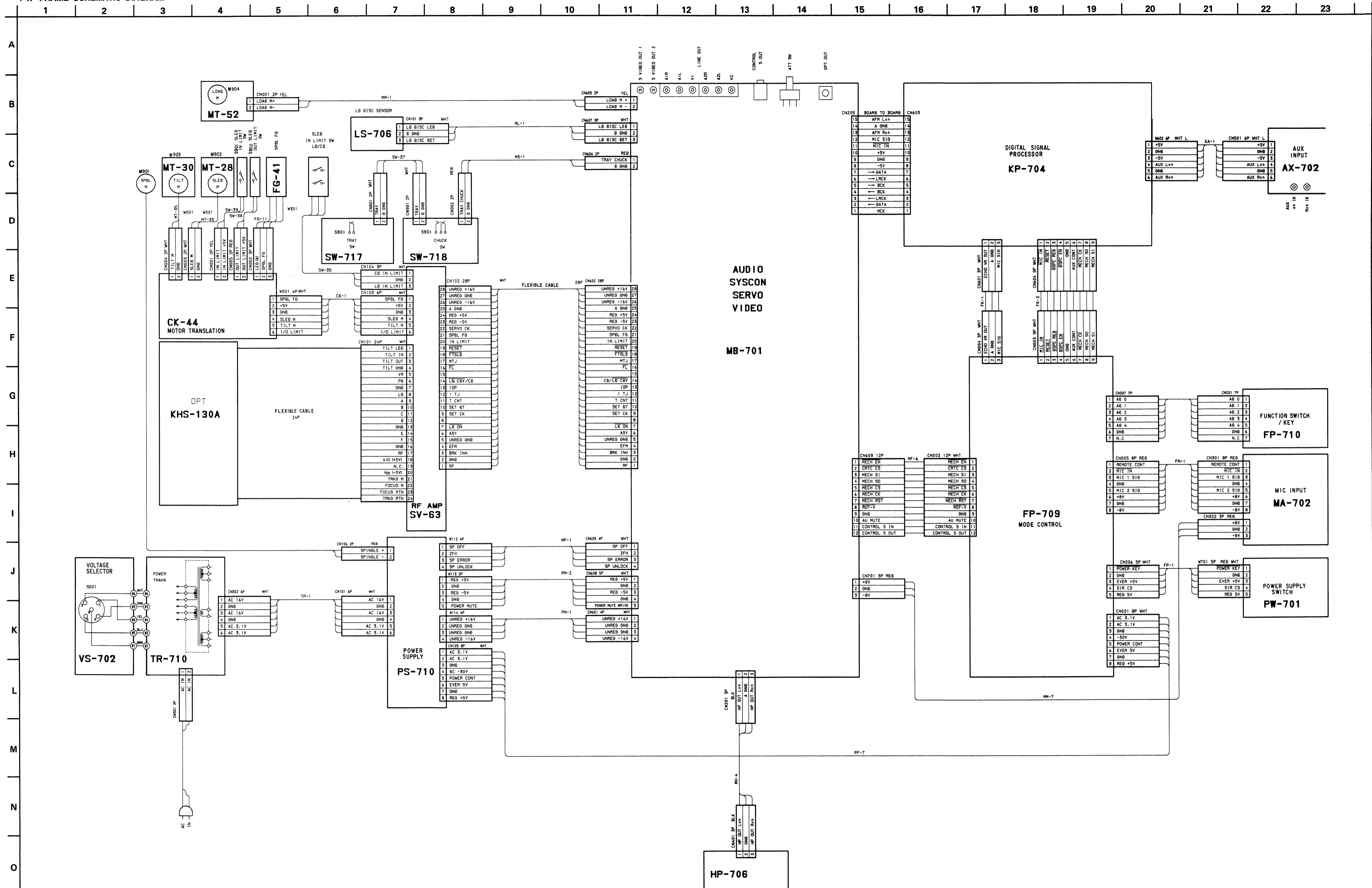

4-2. PRINTED WIRING BOARDS AND SCHEMATIC DIAGRAMS

THIS NOTE IS COMMON FOR PRINTED WIRING BOARDS AND SCHEMATIC DIAGRAMS. (In addition to this, the necessary note is printed in each block.)

- For printed wiring boards:
- : indicates a lead wire mounted on the component side.
 - : indicates a lead wire mounted on the printed side.
 - (with dot) : Through hole.
 - (with dot) : Pattern from the side which enables seeing. (The other layers' patterns are not indicated.)

Caution:
 Pattern face side: Parts on the pattern face side seen from the (Conductor Side)
 Parts face side: Parts on the parts face side seen from the (Component Side)

- *For schematic diagram:
- Caution when replacing chip parts. New parts must be attached after removal of chip. Be careful not to heat the minus side of tantalum capacitor, because it is damaged by the heat.
 - All resistors are in ohms, 1/4W (Chip resistors: 1/10W) unless otherwise noted. kΩ: 1000Ω, MΩ: 1000kΩ.
 - All capacitors are in μF unless otherwise noted. pF: μF/50V or less are not indicated except for electrolytics and tantalums.
 - All variable and adjustable resistors have characteristic curve B, unless otherwise noted.
 - ⊠ : nonflammable resistor.
 - ⊠ (with diagonal line) : fusible resistor.
 - ⊠ (with horizontal line) : panel designation.
 - ⊠ (with vertical line) : internal component.
 - ⊠ (with diagonal line and horizontal line) : adjustment for repair.*
 - ⊠ (with diagonal line and vertical line) : B+ Line.*
 - ⊠ (with diagonal line and horizontal line) : B- Line.*
 - Voltages are dc between measurement points and ground unless otherwise noted.*
 - Readings are taken with a color-bar signal playback.*
 - Readings are taken with a digital multimeter (DC10MΩ).*
 - Voltage variations may be noted due to normal production tolerances.
 - ⊠ (with arrow) : IN/OUT direction of B line (+, -,)*
 - ⊠ (with circle) : Circled numbers refer to waveforms.*

When indicating parts by reference number, please include the board name.

Note: The components identified by mark ⊠ or dotted line with mark ⊠ are critical for safety. Replace only with part number specified.

* : indicated by the color red.

SV-63 BOARD

- D001 G-10
- D101 C-7
- D102 E-4
- D103 G-7
- D104 H-11
- IC001 G-9
- IC002 F-11
- IC005 A-27
- IC006 C-27
- IC007 B-27
- IC101 F-7
- IC102 E-3
- IC103 C-8
- IC104 C-8
- IC105 F-1
- IC106 G-11

- Q001 E-10
- Q002 E-9
- Q003 F-11
- Q101 H-3
- Q102 H-2
- Q103 H-2
- Q104 H-1
- Q105 A-12
- Q106 B-12
- Q107 D-6
- Q108 F-4
- Q109 B-6

CK-44 BOARD

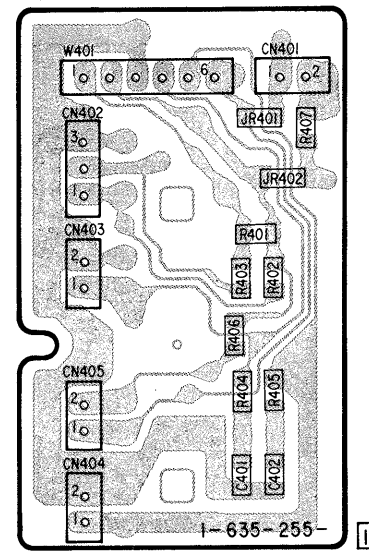

SV-63 BOARD

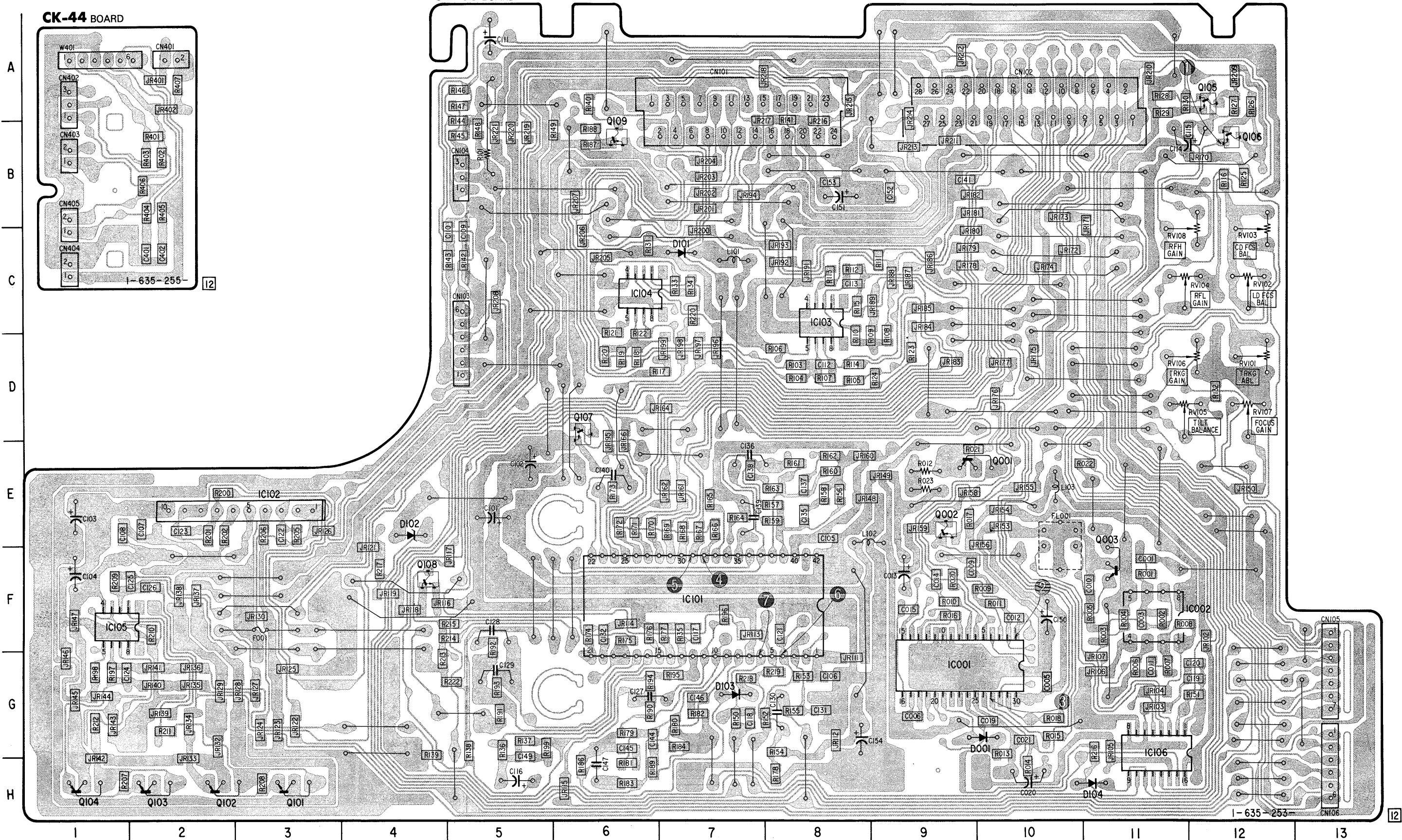

FG-41 BOARD

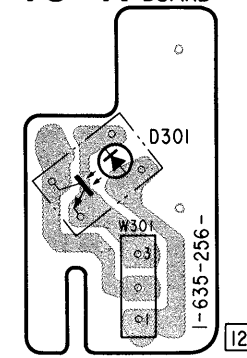

MT-28 BOARD

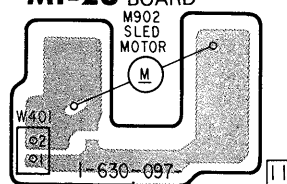

MT-30 BOARD

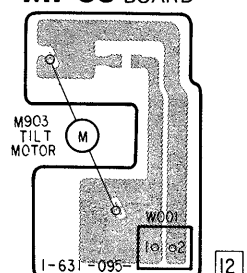

SV-63 BOARD

① Q106 0.5V/2 μs

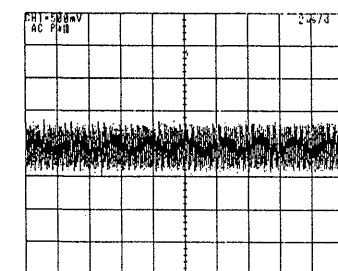

⑦ IC101 50mV/100ns

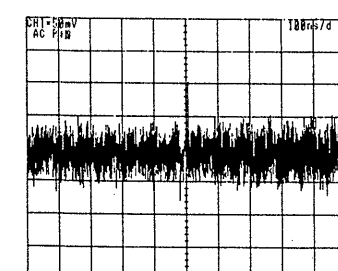

② IC001 0.2V/50ms

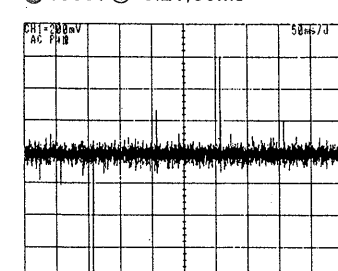

③ IC001 2V/2 μs

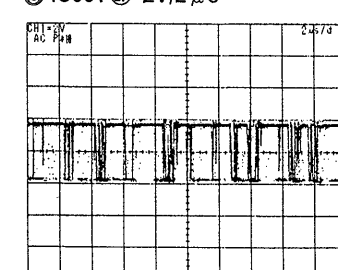

④ IC101 2V/1ms

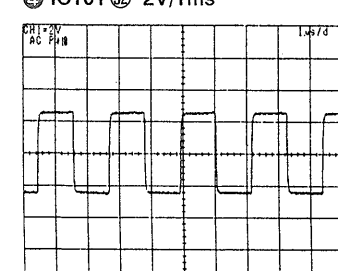

⑤ IC101 0.1V/1 μs

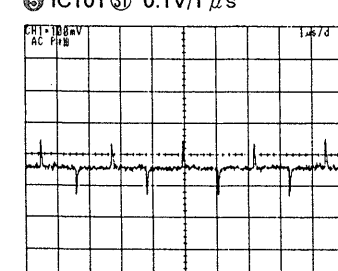

⑥ IC101 50mV/100ns

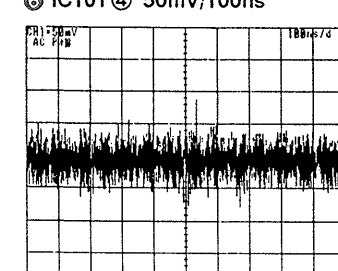

IC BLOCK DIAGRAMS

CXD8404Q

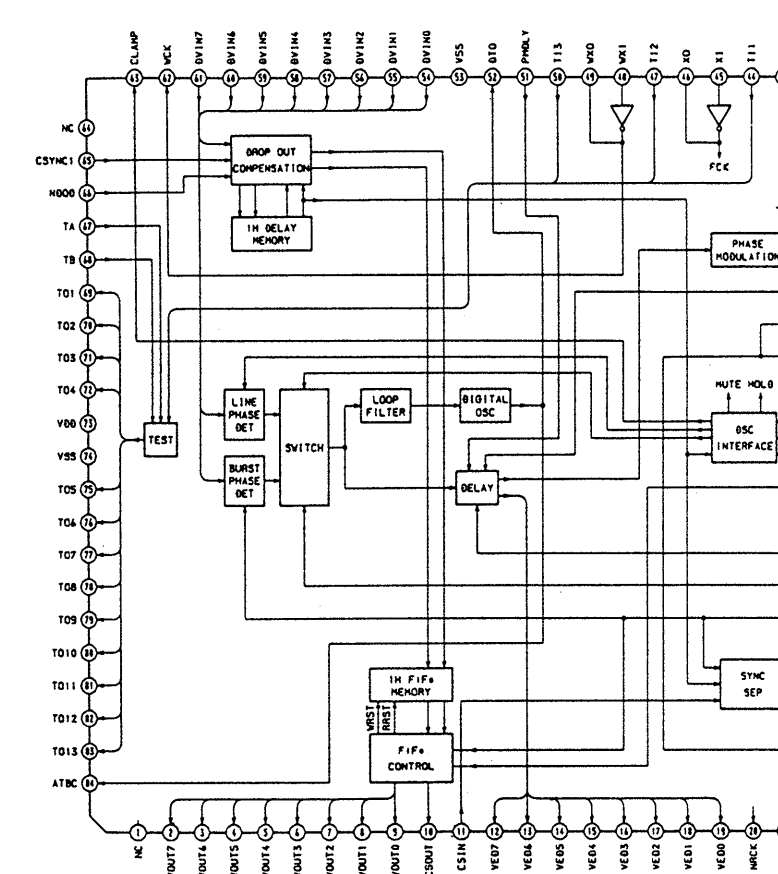

CXD8405Q

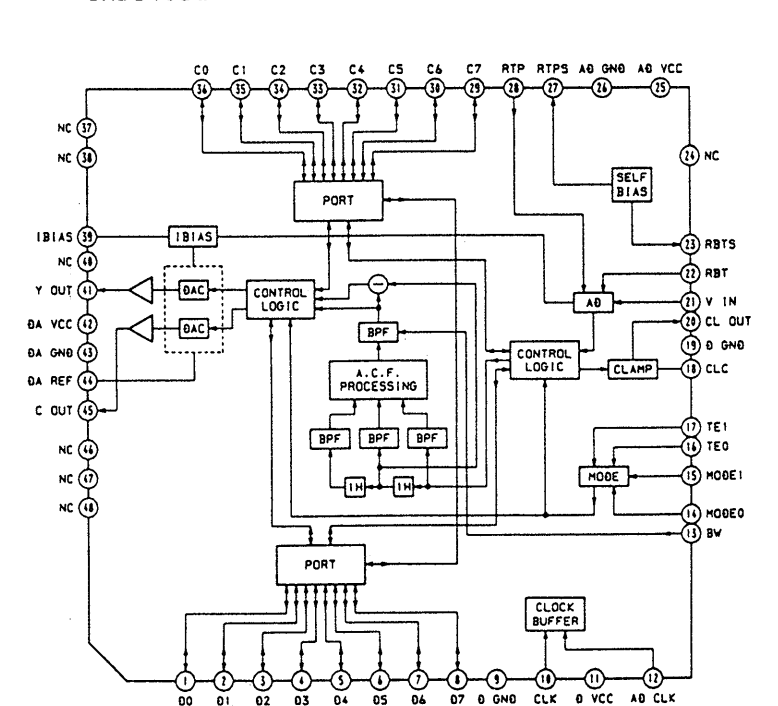

MB-701 (VIDEO) PRINTED WIRING BOARD

— Ref. No.: MB-701 Board; 2,000 series —

- | | | | |
|------|------|------|------|
| D001 | C-4 | Q214 | D-18 |
| D002 | C-4 | Q215 | D-17 |
| D003 | D-21 | Q216 | D-17 |
| D004 | C-22 | Q217 | F-23 |
| D201 | F-8 | Q218 | G-2 |
| D202 | F-8 | Q219 | F-24 |
| D203 | D-16 | Q220 | G-22 |
| D204 | E-18 | Q222 | E-18 |
| D205 | D-17 | Q223 | D-11 |
| D207 | D-17 | Q224 | D-12 |
| D208 | E-18 | Q225 | E-12 |
| D212 | E-18 | Q226 | F-12 |
| D213 | A-20 | Q229 | F-21 |
| D214 | A-20 | Q230 | E-21 |
| D215 | A-18 | Q801 | A-23 |
| D216 | A-18 | Q809 | B-2 |
| D401 | C-24 | Q701 | G-16 |
| D602 | B-25 | | |
| D699 | F-25 | | |
| D701 | G-9 | | |

- | | |
|-------|------|
| IC001 | C-7 |
| IC003 | B-9 |
| IC004 | E-6 |
| IC005 | C-9 |
| IC007 | B-9 |
| IC201 | A-24 |
| IC202 | E-11 |
| IC203 | F-11 |
| IC204 | E-8 |
| IC205 | E-12 |
| IC207 | E-17 |
| IC208 | F-6 |
| IC209 | F-17 |
| IC210 | F-11 |
| IC211 | F-21 |
| IC212 | F-22 |
| IC214 | F-9 |
| IC401 | C-2 |
| IC402 | C-24 |
| IC601 | B-3 |
| IC603 | E-25 |
| IC604 | D-3 |
| IC701 | F-14 |
| IC702 | G-14 |
| IC703 | G-16 |

- | | |
|------|------|
| Q001 | C-20 |
| Q002 | D-20 |
| Q003 | D-21 |
| Q004 | C-20 |
| Q005 | C-19 |
| Q008 | D-21 |
| Q010 | B-20 |
| Q012 | B-6 |
| Q013 | C-21 |
| Q014 | B-20 |
| Q016 | A-20 |
| Q018 | A-19 |
| Q017 | D-5 |
| Q018 | D-22 |
| Q019 | D-21 |
| Q020 | C-20 |
| Q023 | B-9 |
| Q024 | A-22 |
| Q025 | B-22 |
| Q026 | D-18 |
| Q027 | A-5 |
| Q028 | C-17 |
| Q029 | A-5 |
| Q030 | A-5 |
| Q031 | C-17 |
| Q032 | A-5 |
| Q033 | A-5 |
| Q034 | A-5 |
| Q035 | A-5 |
| Q037 | D-21 |
| Q039 | B-18 |
| Q040 | B-7 |
| Q041 | B-19 |
| Q201 | G-20 |
| Q202 | D-16 |
| Q203 | D-11 |
| Q204 | D-11 |
| Q205 | D-18 |
| Q206 | D-14 |
| Q207 | D-14 |
| Q208 | D-12 |
| Q209 | D-18 |
| Q210 | E-10 |
| Q211 | E-10 |
| Q212 | D-10 |
| Q213 | D-18 |

MB-701 BOARD (COMPONENT SIDE)

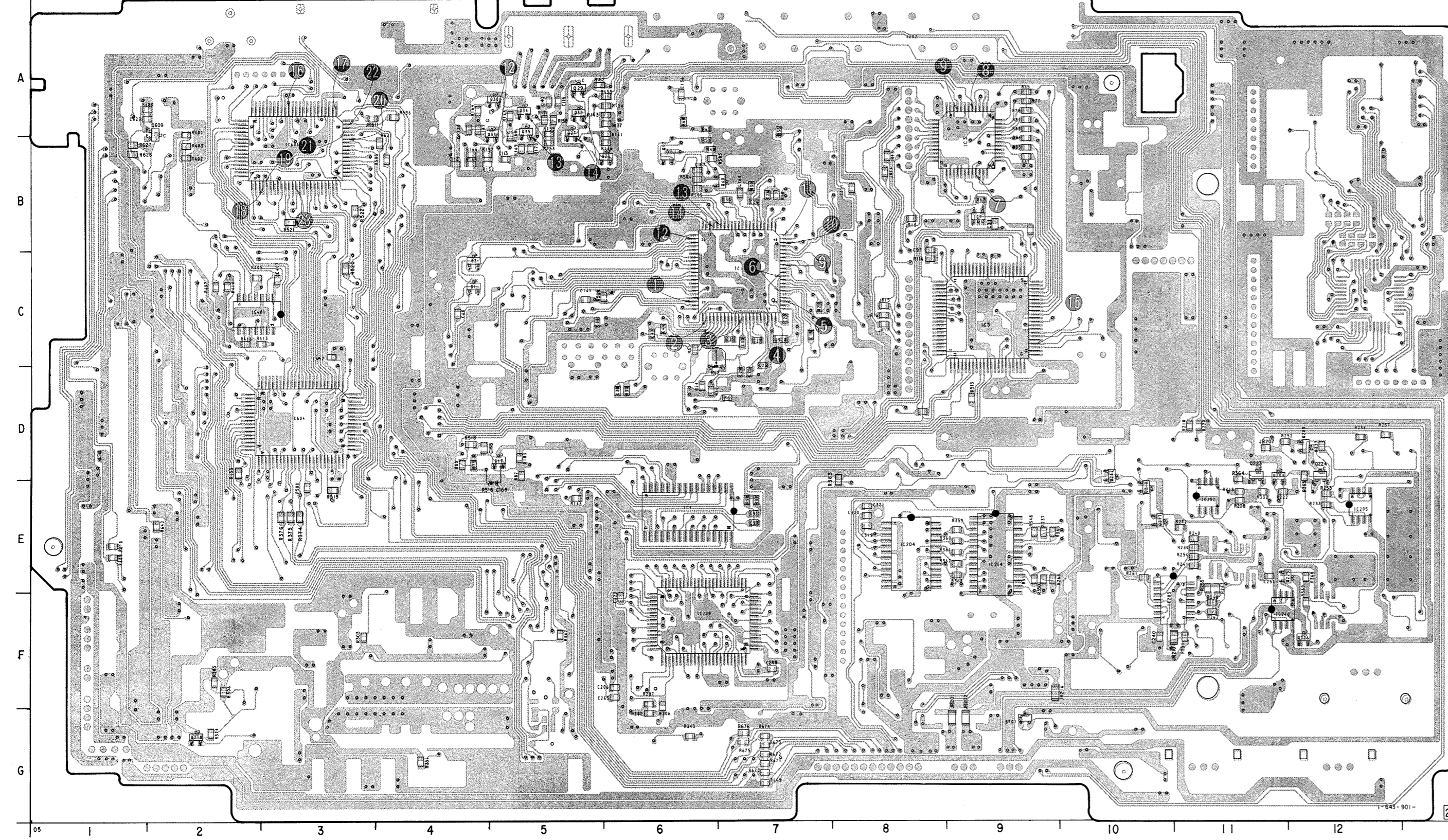

MB-701 BOARD (CONDUCTOR SIDE)

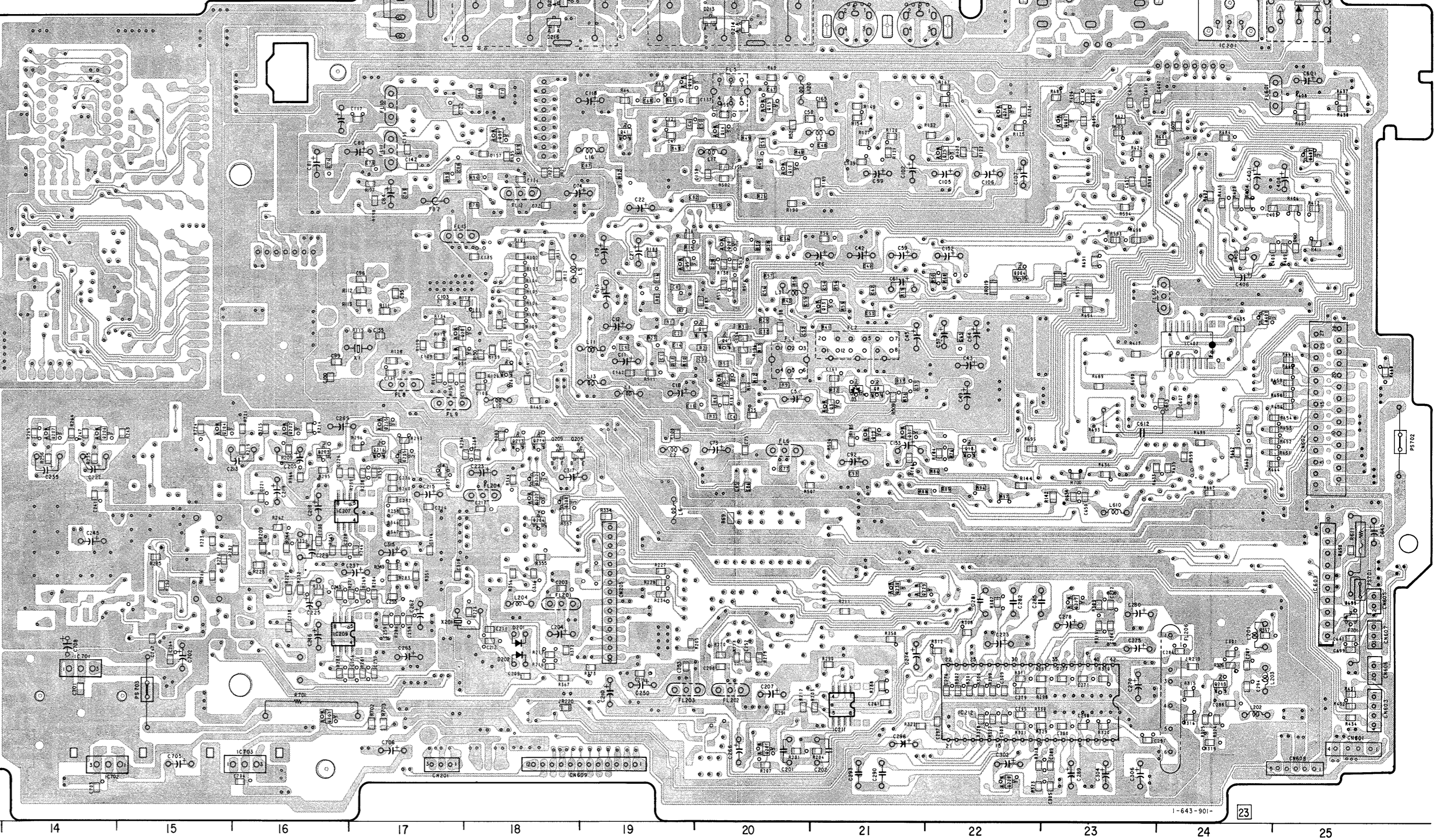

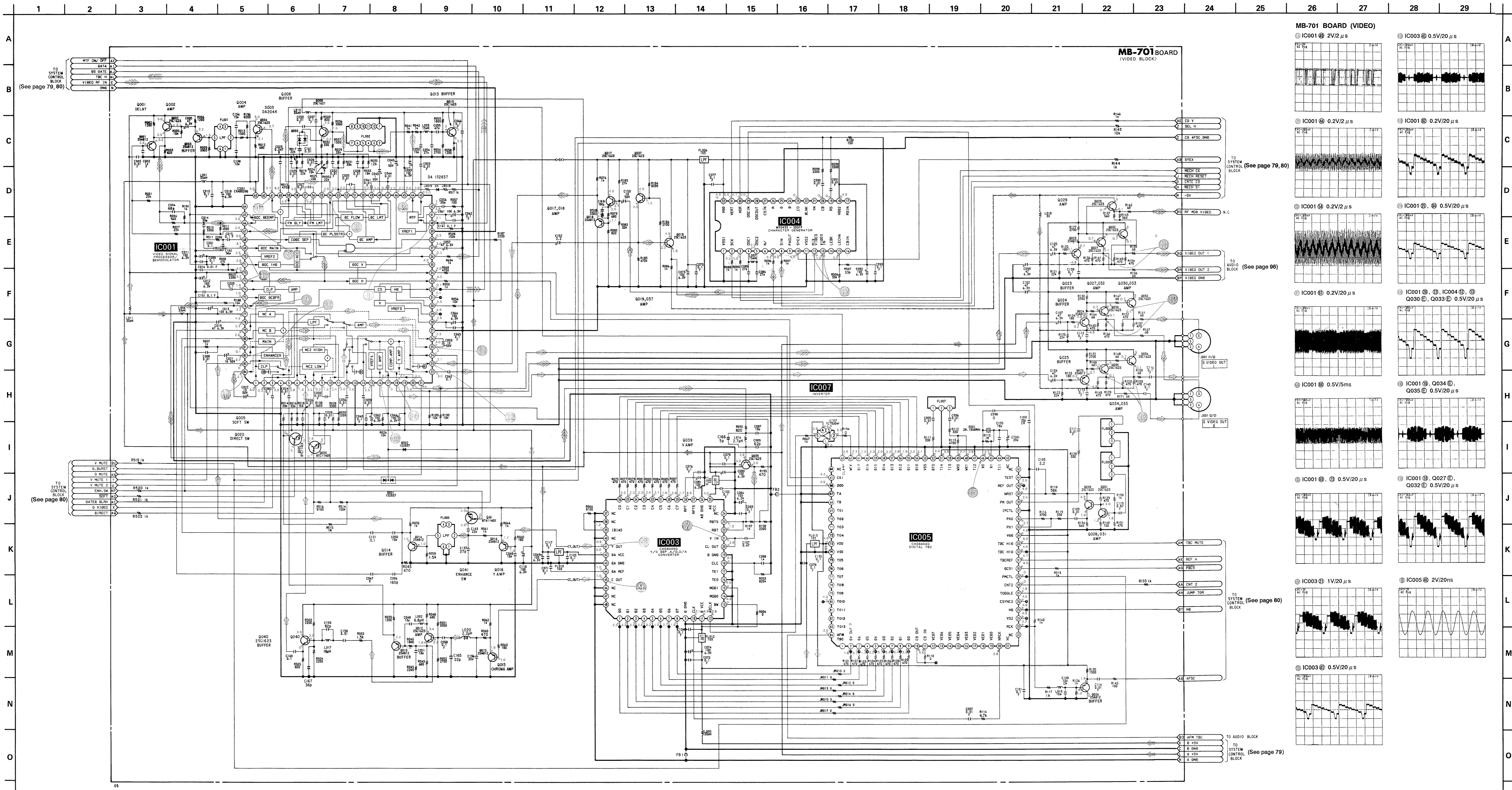

	VIDEO SIGNAL			AUDIO SIGNAL
	CHROMA	Y	Y/CHROMA	
PB	→	→	→	→

SPINDLE PHASE SERVO	→
SPINDLE SERVO (SPEED AND PHASE)	→
TRACKING SERVO LD/CD/CDV	→
SLIDE SERVO LD/CD	→
FOCUS SERVO LD/CD	→
SKREW SERVO LD TILT	→

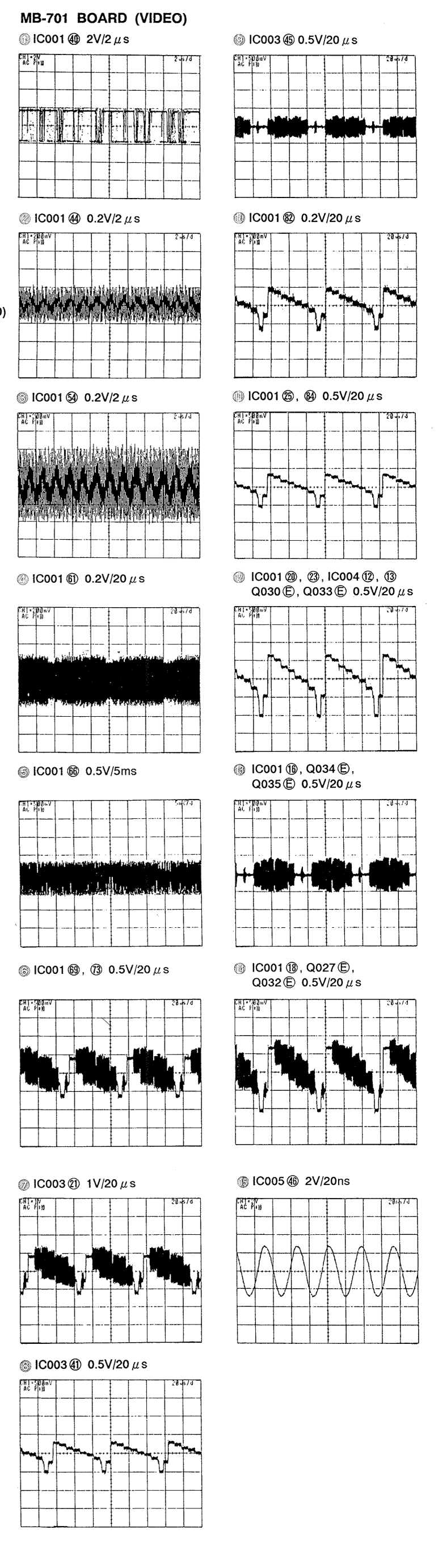

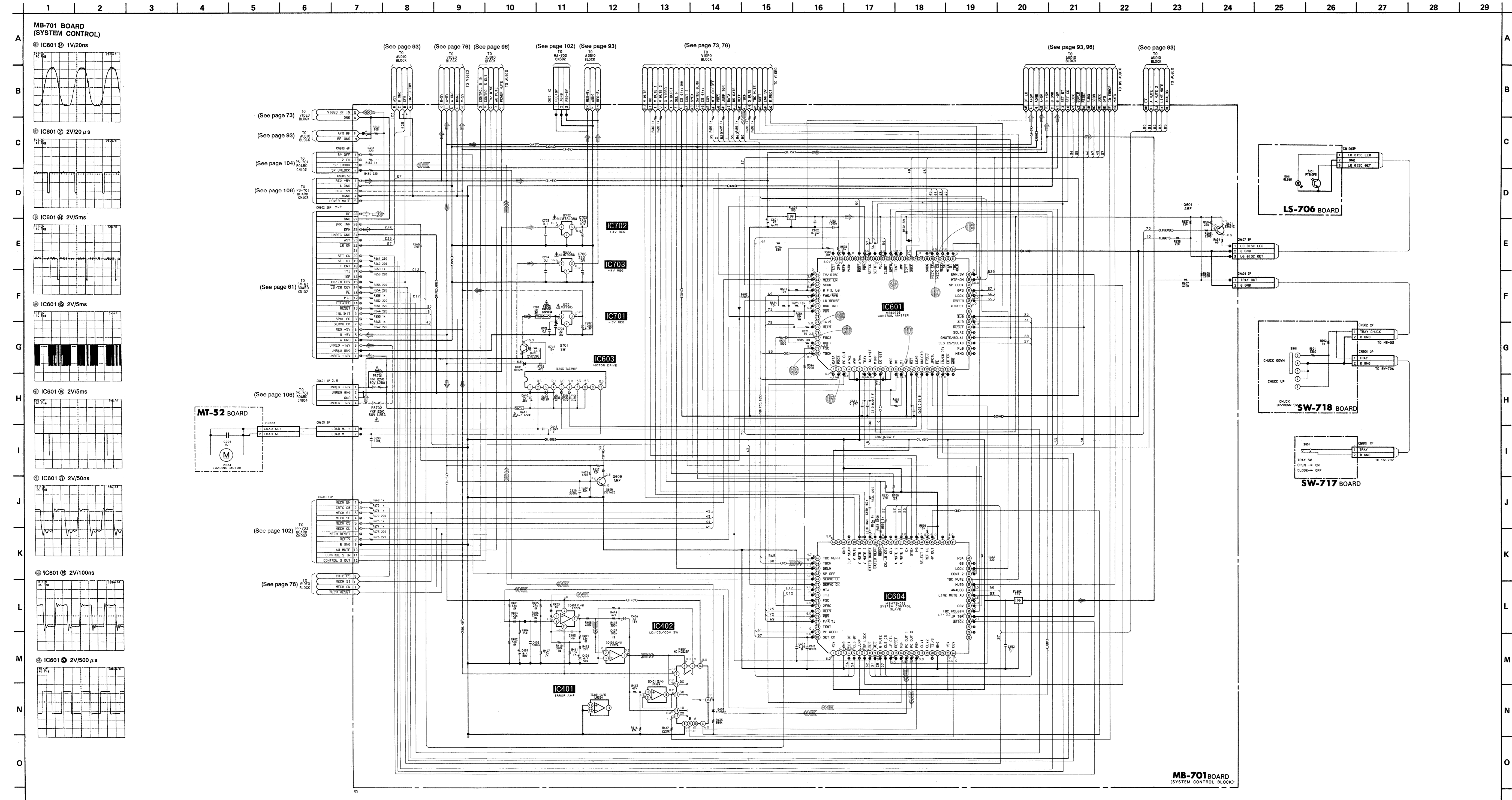

LS-706 (LD SENSOR), MT-52 (LOADING MOTOR), SW-717 (TRAY SWITCH), SW-718 (CHUCK SWITCH) PRINTED WIRING BOARDS
 - Ref. No.: LS-706, MT-52, SW-717, and SW-718 Boards; 3,000 series -

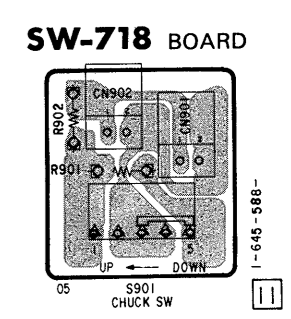
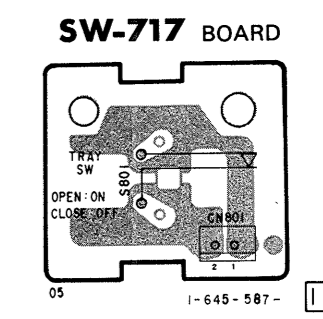
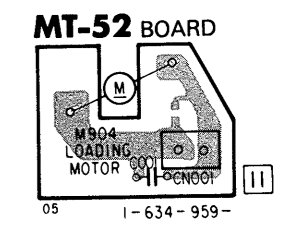
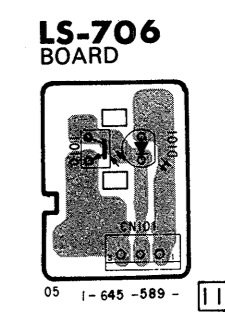

PB	VIDEO SIGNAL		AUDIO SIGNAL
	CHROMA	Y	
CHROMA	→	→	→
Y	→	→	→

SPINDLE PHASE SERVO	→
SPINDLE SERVO (SPEED AND PHASE)	→
TRACKING SERVO LD/CD/CDV	→
SLIDE SERVO LD/CD	→
FOCUS SERVO LD/CD	→
SKREW SERVO LD TILT	→

- | | | | |
|-------|------|------|------|
| D001 | C-4 | O214 | D-18 |
| D002 | C-4 | O215 | D-17 |
| D003 | D-21 | O216 | D-17 |
| D004 | C-22 | O217 | F-23 |
| D201 | F-9 | O218 | G-2 |
| D202 | F-8 | O219 | F-24 |
| D203 | D-16 | O220 | G-22 |
| D204 | E-18 | O222 | E-18 |
| D205 | D-17 | O223 | D-11 |
| D207 | D-17 | O224 | D-12 |
| D208 | E-18 | O225 | E-12 |
| D212 | E-18 | O226 | F-12 |
| D213 | A-20 | O229 | F-21 |
| D214 | A-20 | O230 | E-21 |
| D215 | A-18 | O601 | A-23 |
| D216 | A-18 | O609 | B-2 |
| D401 | C-24 | O701 | G-16 |
| D602 | B-25 | | |
| D699 | F-25 | | |
| D701 | G-9 | | |
| IC001 | C-7 | | |
| IC003 | B-9 | | |
| IC004 | E-6 | | |
| IC005 | C-9 | | |
| IC007 | B-9 | | |
| IC201 | A-24 | | |
| IC202 | E-11 | | |
| IC203 | F-11 | | |
| IC204 | E-8 | | |
| IC205 | E-12 | | |
| IC207 | E-17 | | |
| IC208 | F-6 | | |
| IC209 | F-17 | | |
| IC210 | F-11 | | |
| IC211 | F-21 | | |
| IC212 | F-22 | | |
| IC214 | E-9 | | |
| IC401 | C-2 | | |
| IC402 | C-24 | | |
| IC601 | B-3 | | |
| IC603 | E-25 | | |
| IC604 | D-3 | | |
| IC701 | F-14 | | |
| IC702 | G-14 | | |
| IC703 | G-16 | | |
| O001 | C-20 | | |
| O002 | D-20 | | |
| O003 | D-21 | | |
| O004 | C-20 | | |
| O005 | C-19 | | |
| O008 | D-21 | | |
| O010 | B-20 | | |
| O012 | B-6 | | |
| O013 | C-21 | | |
| O014 | B-20 | | |
| O015 | A-20 | | |
| O016 | A-19 | | |
| O017 | D-5 | | |
| O018 | D-22 | | |
| O019 | D-21 | | |
| O020 | C-20 | | |
| O023 | B-6 | | |
| O024 | A-22 | | |
| O025 | B-22 | | |
| O026 | D-18 | | |
| O027 | A-5 | | |
| O028 | C-17 | | |
| O029 | A-5 | | |
| O030 | A-5 | | |
| O031 | C-17 | | |
| O032 | A-5 | | |
| O033 | A-5 | | |
| O034 | A-5 | | |
| O035 | A-5 | | |
| O037 | D-21 | | |
| O039 | B-18 | | |
| O040 | B-7 | | |
| O041 | B-19 | | |
| O201 | G-20 | | |
| O202 | D-16 | | |
| O203 | D-11 | | |
| O204 | D-15 | | |
| O205 | D-18 | | |
| O206 | D-14 | | |
| O207 | D-14 | | |
| O208 | D-12 | | |
| O209 | D-18 | | |
| O210 | E-10 | | |
| O211 | D-10 | | |
| O212 | D-10 | | |
| O213 | D-18 | | |

MB-701 BOARD (COMPONENT SIDE)

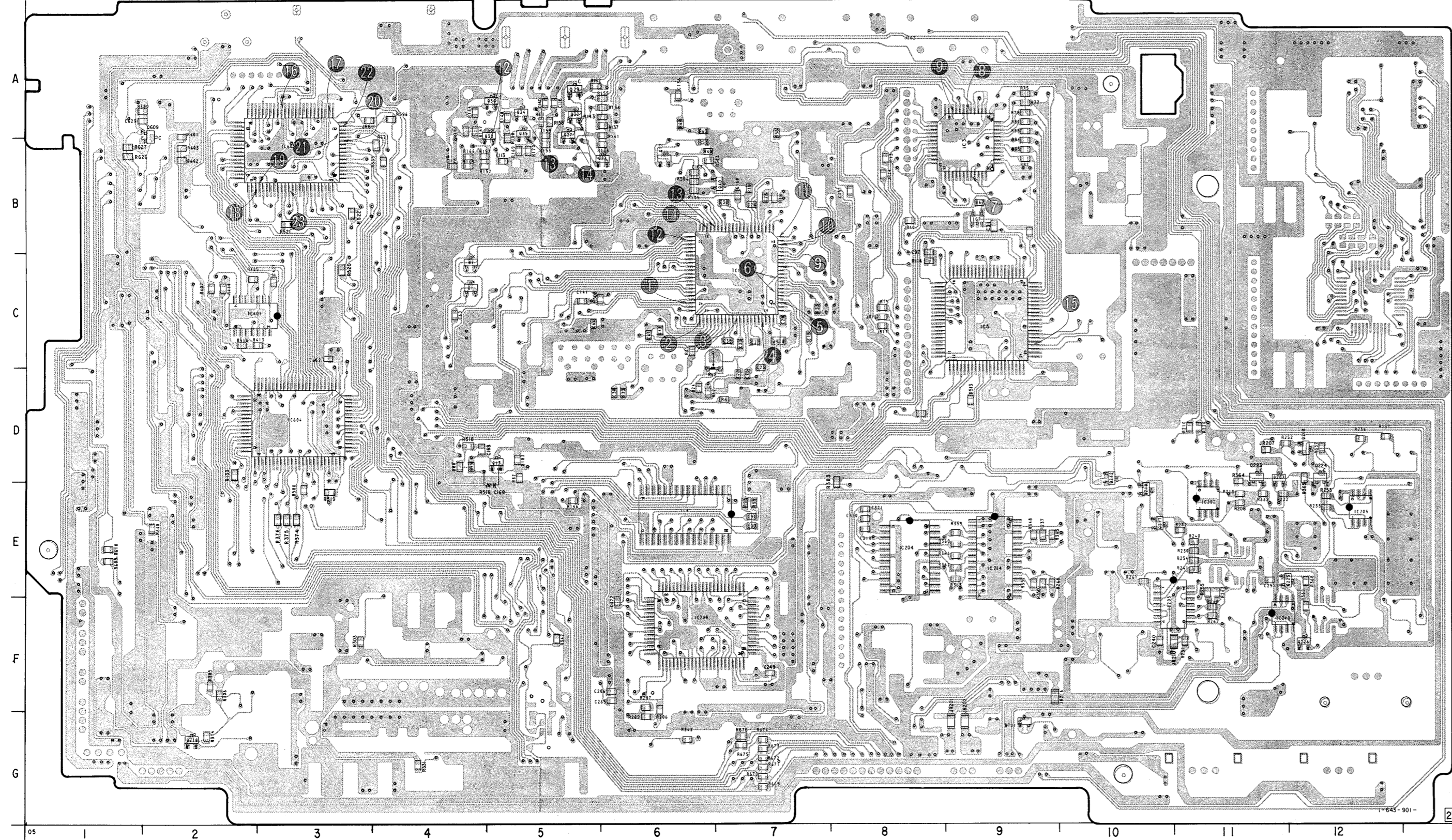

MB-701 BOARD (CONDUCTOR SIDE)

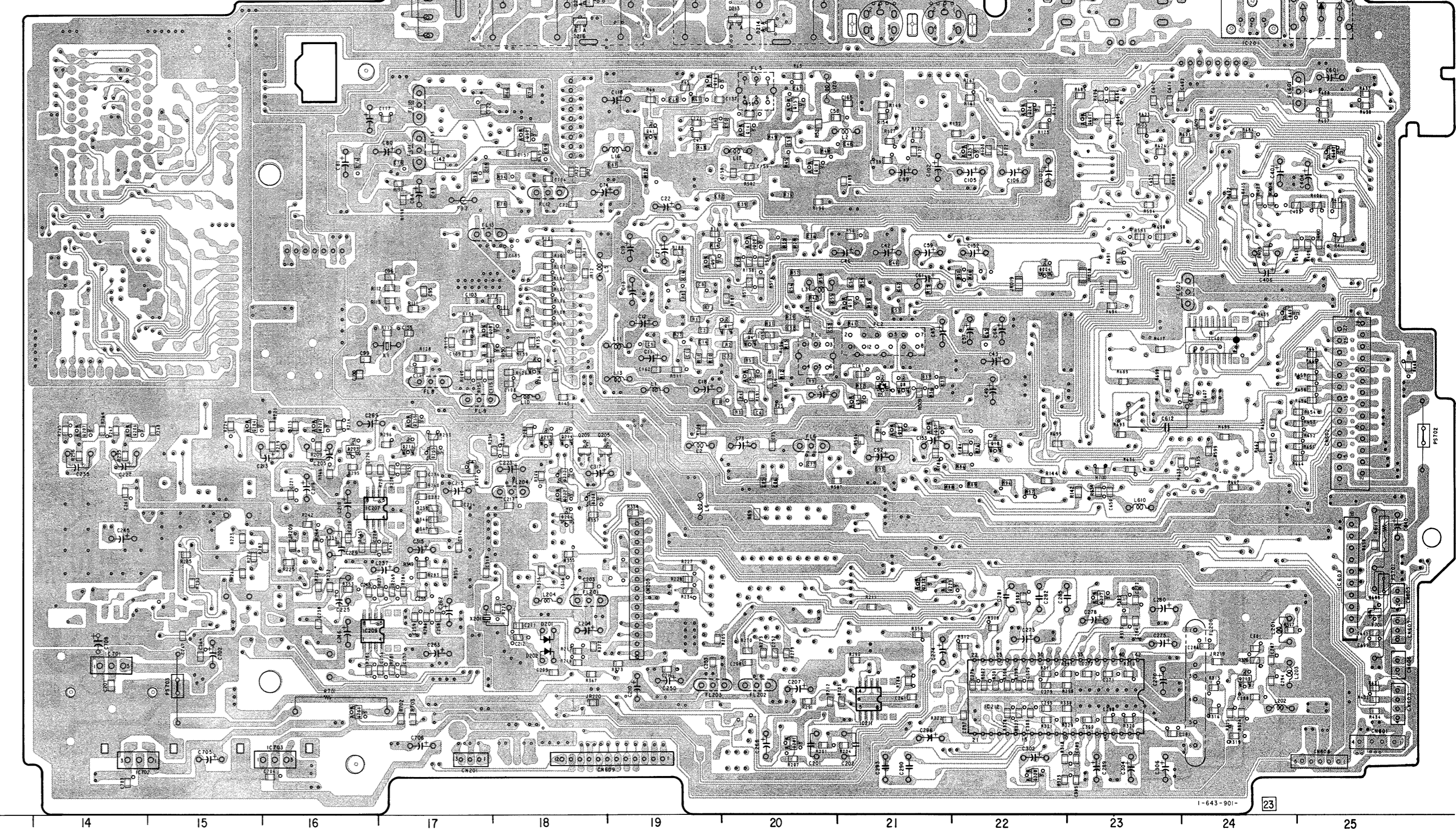

- D001 C-4
- D002 C-4
- D003 D-21
- D004 C-22
- D201 F-8
- D202 F-8
- D203 D-16
- D204 E-18
- D205 D-17
- D207 D-17
- D208 E-18
- D212 E-18
- D213 A-20
- D214 A-20
- D215 A-18
- D216 A-18
- D401 C-24
- D602 B-25
- D609 F-25
- D701 G-9

- IC001 C-7
- IC003 B-9
- IC004 E-6
- IC005 C-9
- IC007 B-9
- IC201 A-24
- IC202 E-11
- IC203 F-11
- IC204 E-11
- IC205 E-12
- IC207 E-17
- IC208 F-6
- IC209 F-17
- IC210 F-11
- IC211 F-21
- IC212 F-22
- IC214 E-9
- IC401 C-2
- IC402 C-24
- IC601 B-3
- IC603 E-25
- IC604 D-3
- IC701 F-14
- IC702 G-14
- IC703 G-16

- Q001 C-20
- Q002 D-20
- Q003 D-21
- Q004 C-20
- Q005 C-19
- Q008 D-21
- Q010 B-20
- Q012 B-6
- Q013 C-21
- Q014 B-20
- Q015 A-20
- Q016 A-19
- Q017 D-5
- Q018 D-22
- Q019 D-21
- Q020 C-20
- Q023 B-5
- Q024 A-22
- Q025 B-22
- Q026 D-18
- Q027 A-5
- Q028 C-17
- Q029 A-5
- Q030 A-5
- Q031 C-17
- Q032 A-5
- Q033 A-5
- Q034 A-5
- Q035 A-5
- Q037 D-21
- Q039 B-18
- Q040 B-7
- Q041 B-19
- Q201 G-20
- Q202 D-16
- Q203 D-11
- Q204 D-15
- Q205 D-18
- Q206 D-14
- Q207 D-14
- Q208 D-12
- Q209 D-18
- Q210 E-10
- Q211 E-10
- Q212 D-10
- Q213 D-18

- Q214 D-18
- Q215 D-17
- Q216 F-23
- Q217 F-23
- Q218 G-2
- Q219 F-24
- Q220 G-22
- Q222 E-18
- Q223 D-11
- Q224 D-12
- Q225 E-12
- Q226 F-12
- Q229 F-21
- Q230 E-21
- Q601 A-23
- Q609 B-2
- Q701 G-16

MB-701 BOARD (COMPONENT SIDE)

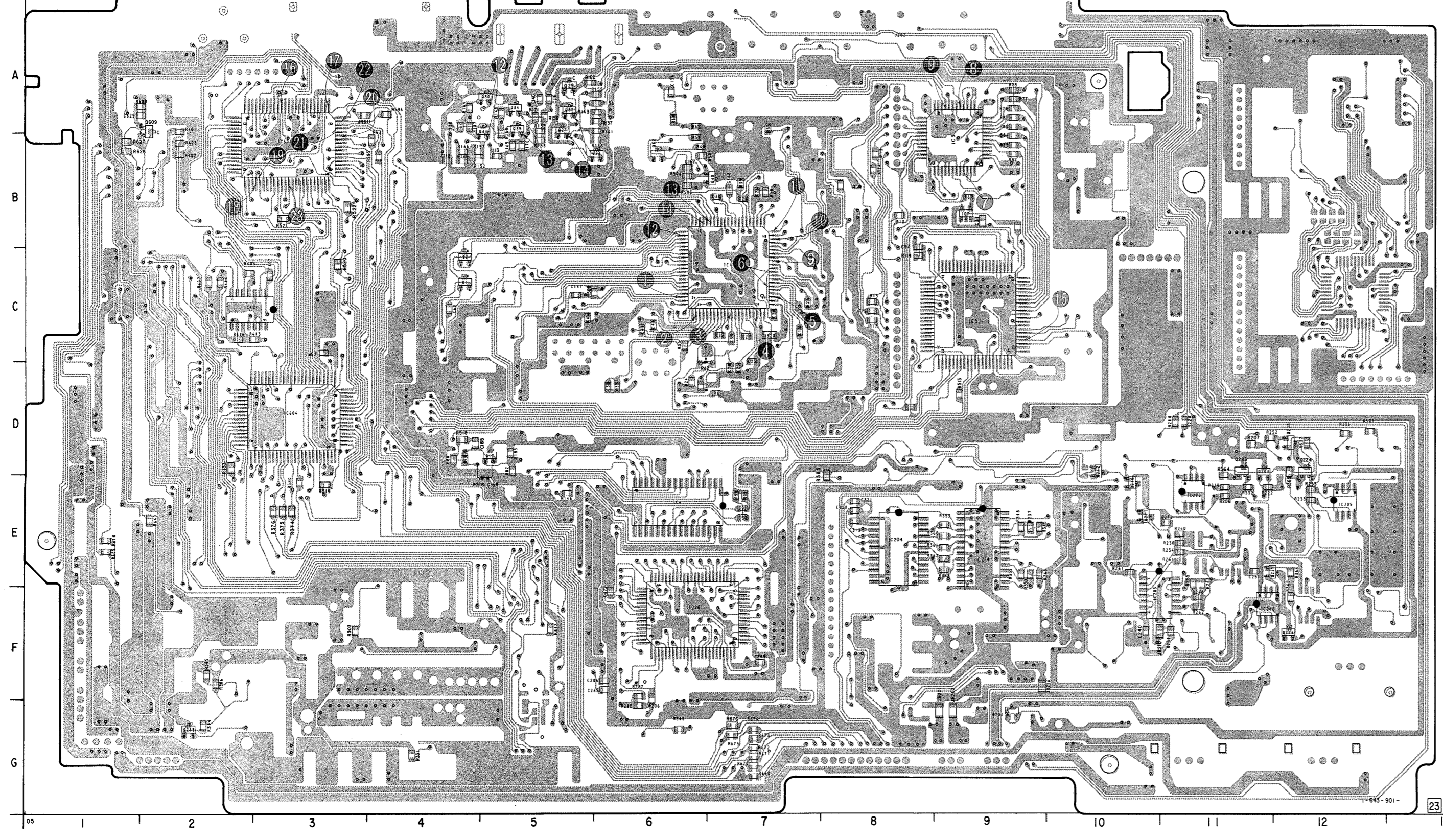

MB-701 BOARD (CONDUCTOR SIDE)

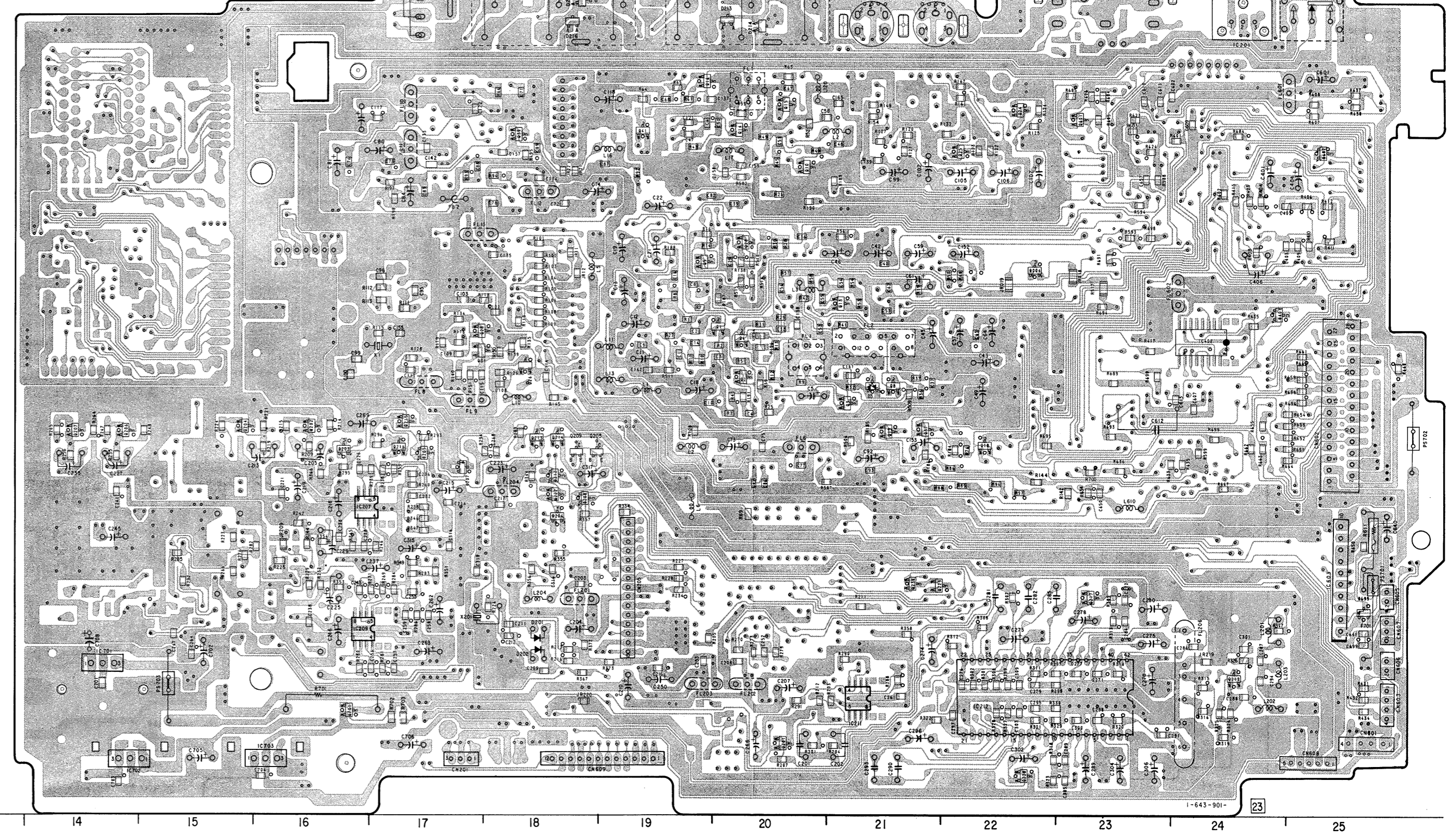

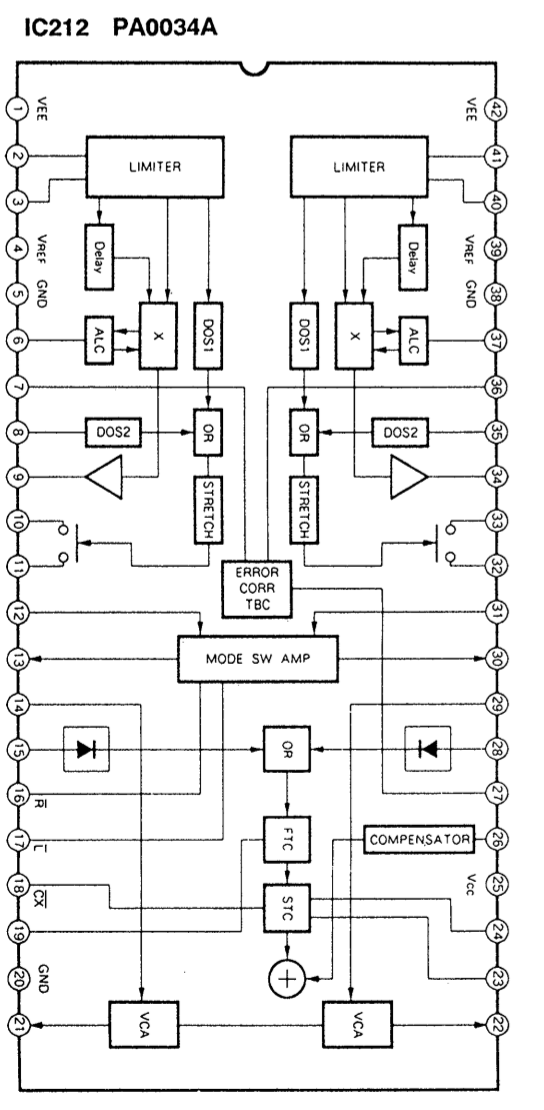
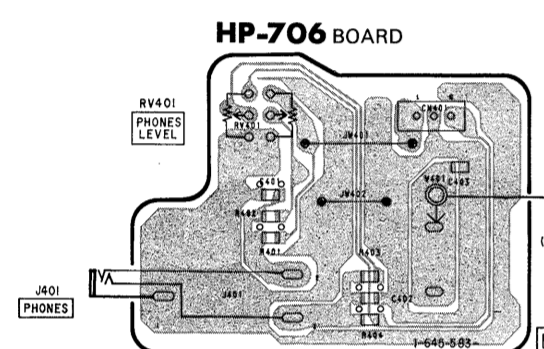
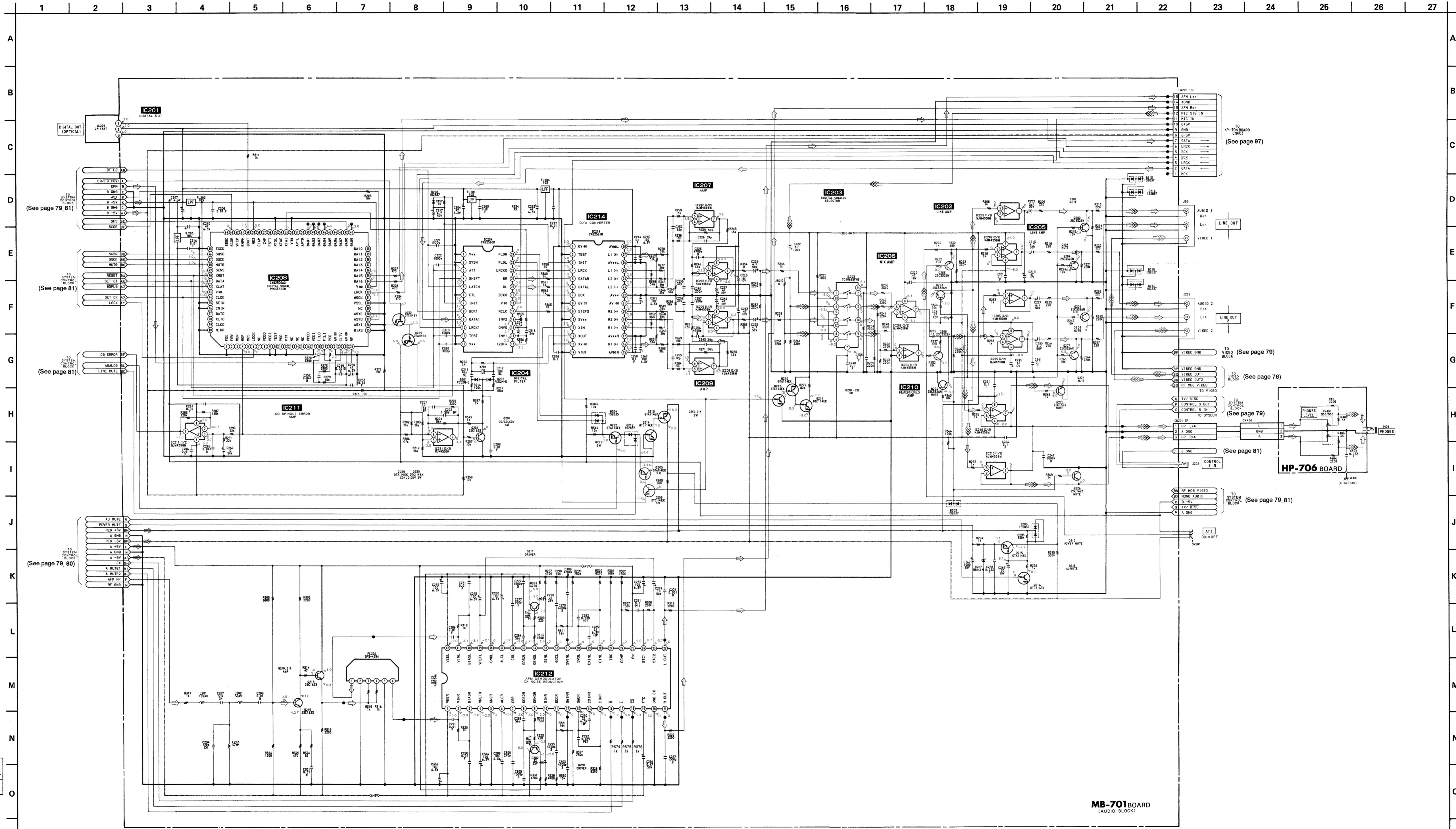

PB	VIDEO SIGNAL			AUDIO SIGNAL	MIC SIGNAL
	CHROMA	Y	Y/CHROMA		
	→	→	→	→	→

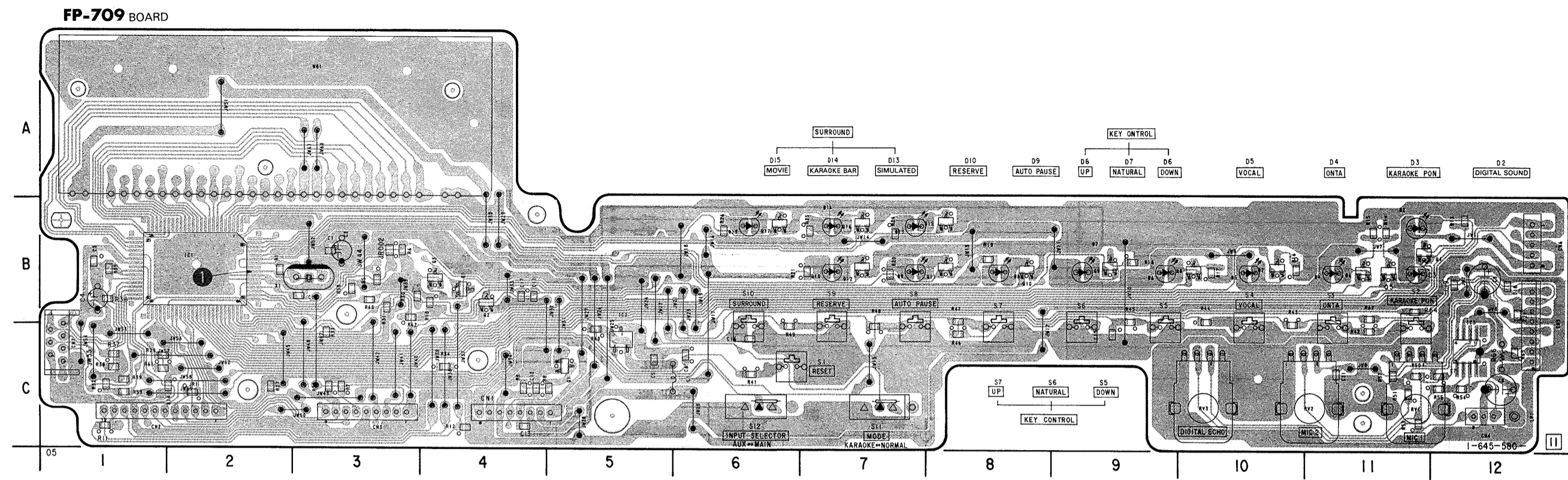

- FP-709 BOARD
- D001 B-4
 - D002 B-11
 - D003 B-11
 - D004 B-11
 - D005 B-10
 - D006 B-9
 - D007 B-8
 - D008 B-8
 - D009 B-7
 - D010 B-7
 - D011 B-7
 - D012 B-7
 - D013 B-7
 - D014 B-7
 - D015 B-8
 - IC001 B-2
 - IC002 C-5
 - IC003 C-12
 - Q001 C-5
 - Q002 B-4
 - Q003 B-4
 - Q004 B-11
 - Q005 B-11
 - Q006 B-11
 - Q007 B-10
 - Q008 B-10
 - Q009 B-8
 - Q010 B-8
 - Q011 B-8
 - Q012 B-7
 - Q013 B-8
 - Q014 B-7
 - Q015 B-8
 - Q016 B-7
 - Q017 B-6

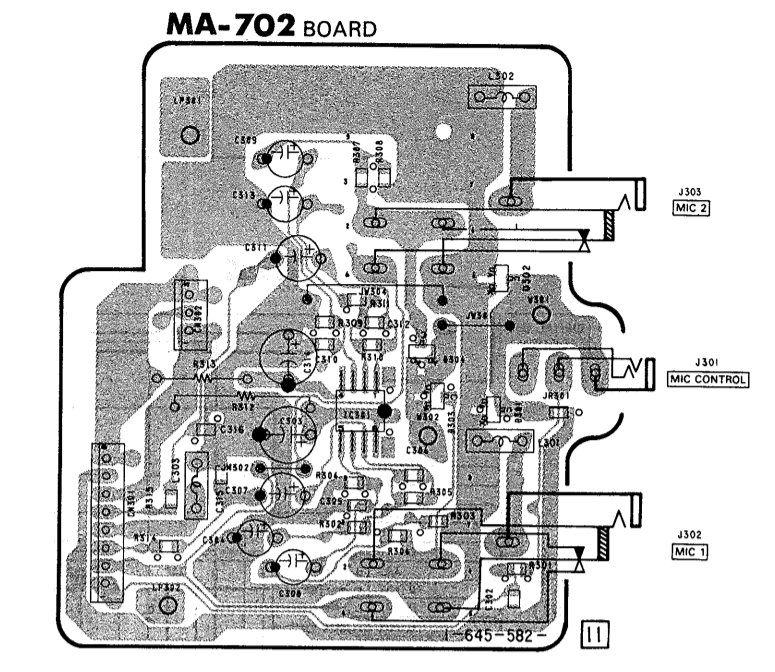
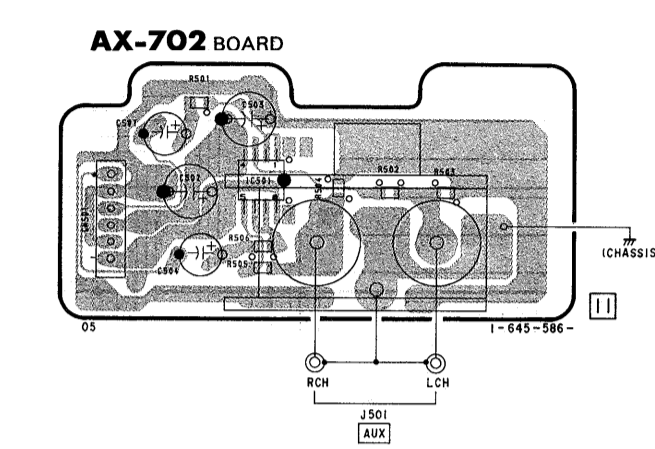
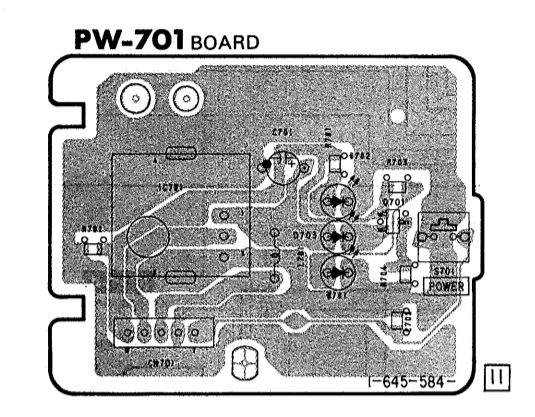
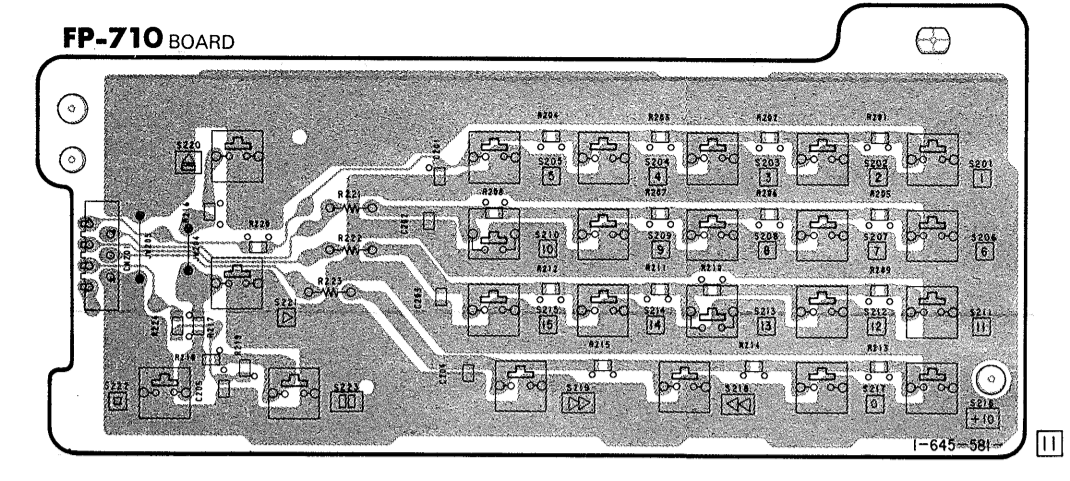

KP-704 (DIGITAL SIGNAL PROCESSOR), AX-702 (AUX INPUT) SCHEMATIC DIAGRAMS
 - Ref. No.: KP-704, AX-702, Boards; 6,000 series -

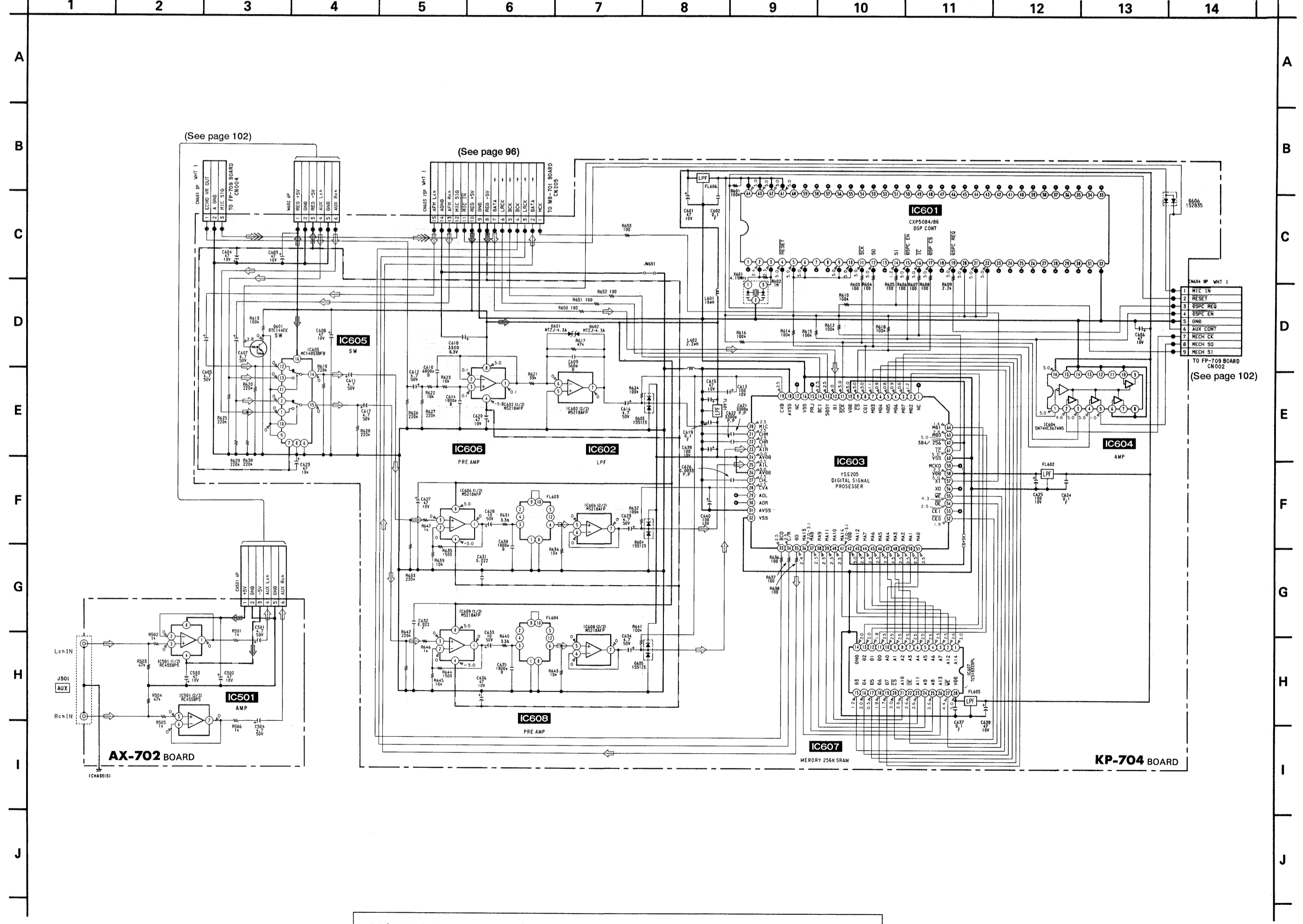

- KP-704 BOARD
- D801 D-7
 - D802 D-7
 - D803 D-7
 - D804 B-5
 - D805 C-8
 - IC801 E-5
 - IC802 D-7
 - IC803 C-4
 - IC804 D-2
 - IC806 B-6
 - IC807 B-4
 - IC808 C-6

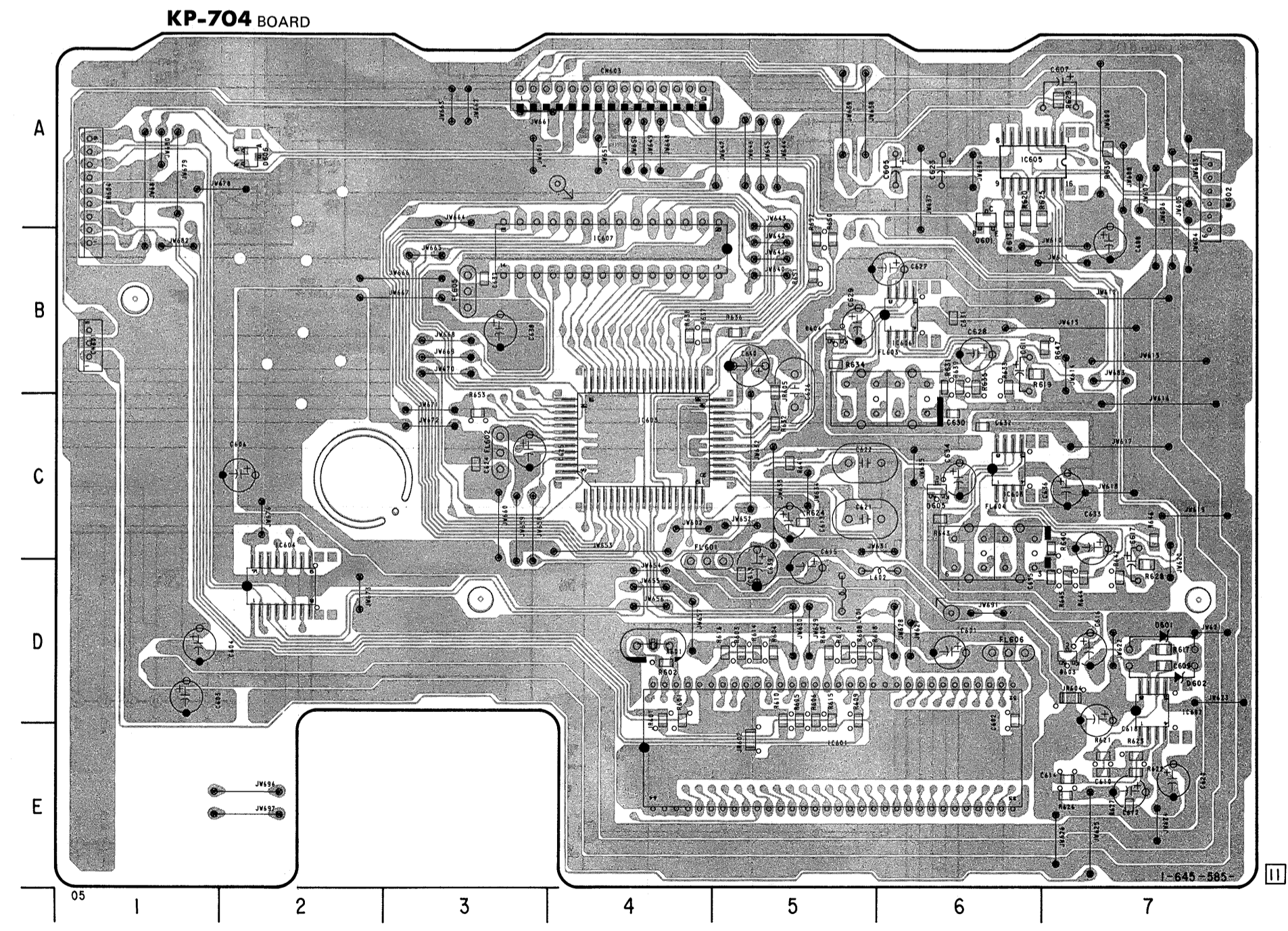

PB	VIDEO SIGNAL		AUDIO SIGNAL	MIC SIGNAL
	CHROMA	Y	Y/CHROMA	
→	⇒	⇒⇒	⇒	⇒⇒⇒

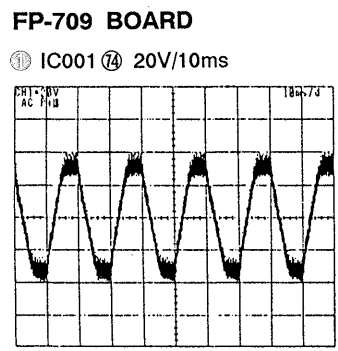
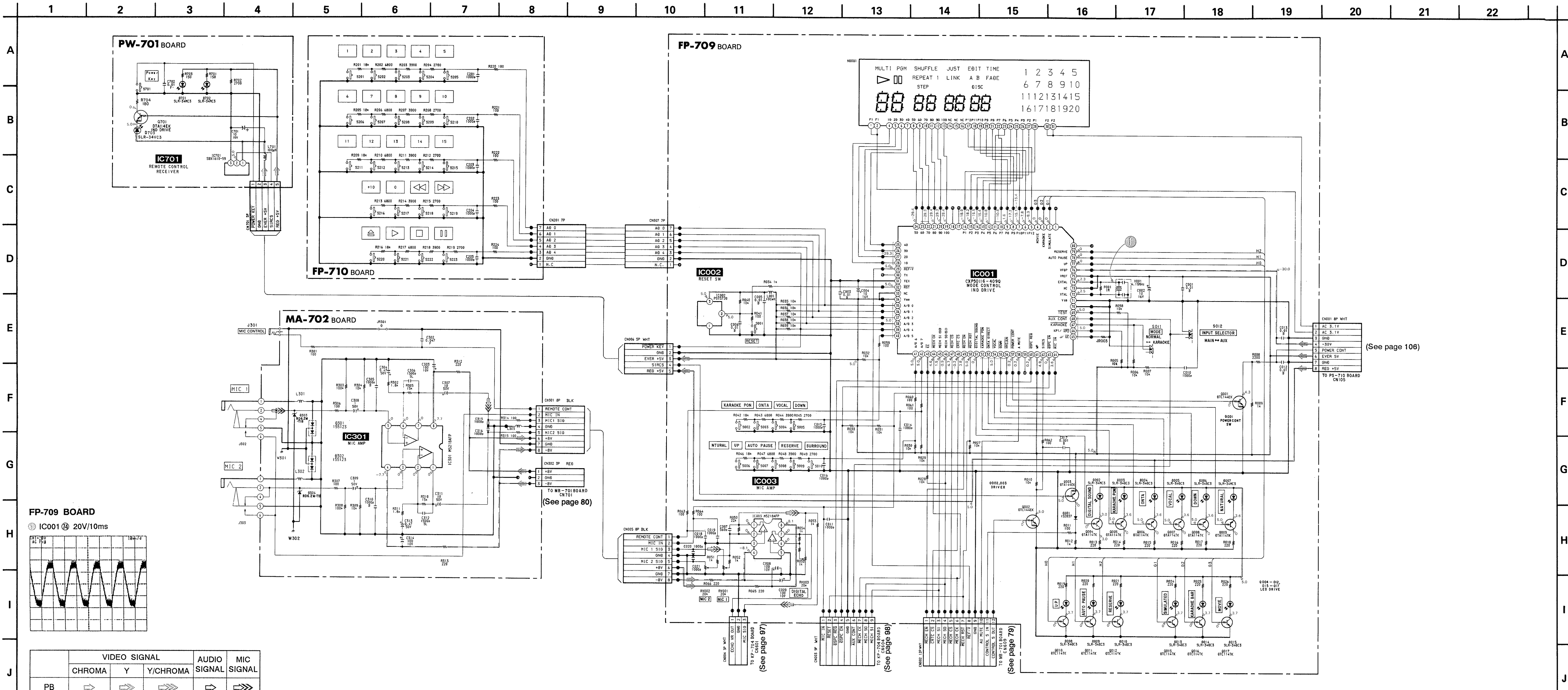

	VIDEO SIGNAL			AUDIO SIGNAL	MIC SIGNAL
	CHROMA	Y	Y/CHROMA		
PB	⇒	⇒⇒	⇒⇒⇒	⇒	⇒⇒⇒

(See page 106)

(See page 80)

(See page 97)

(See page 98)

(See page 79)

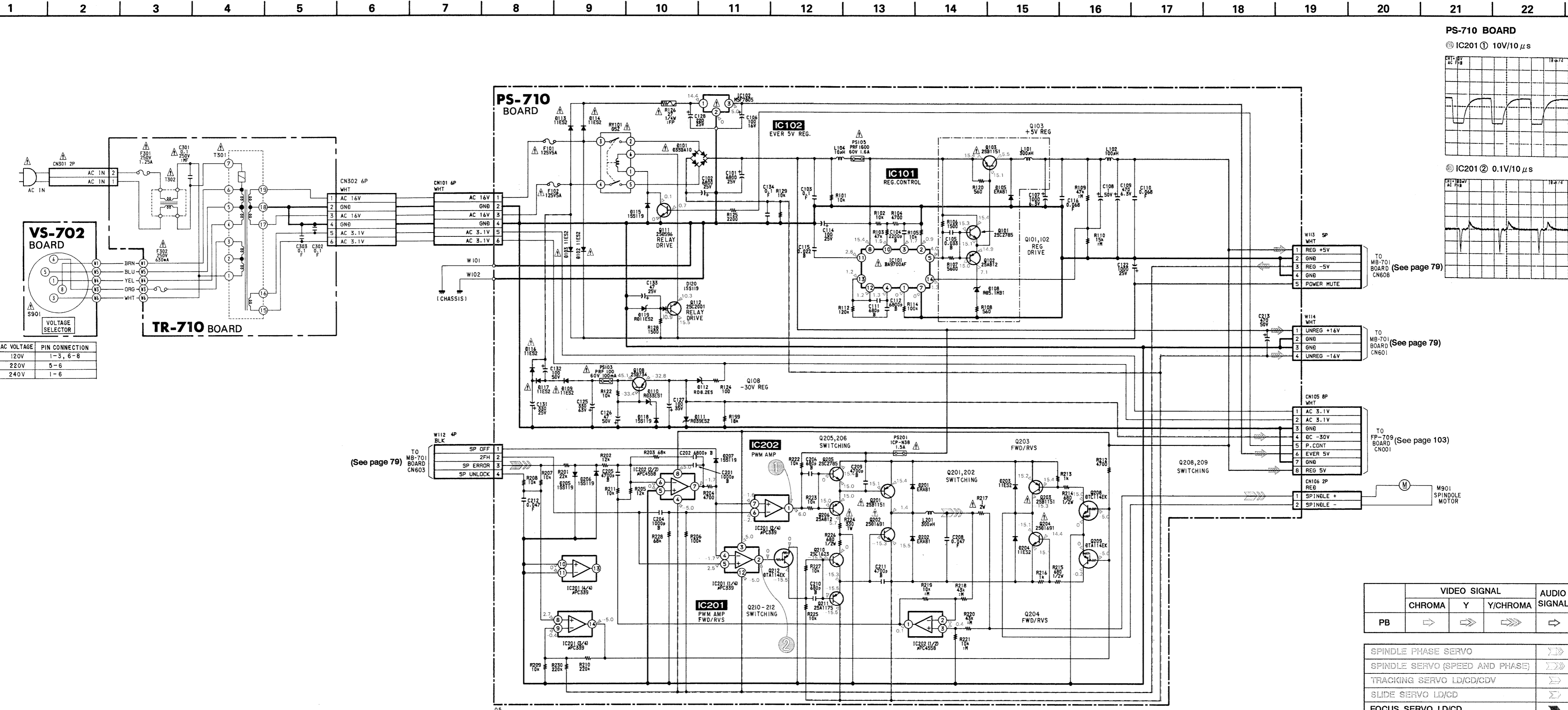

AC VOLTAGE	PIN CONNECTION
120V	1-3, 6-8
220V	5-6
240V	1-6

PS-710 BOARD

IC201 ① 10V/10 μs

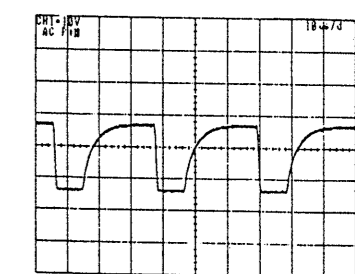

IC201 ② 0.1V/10 μs

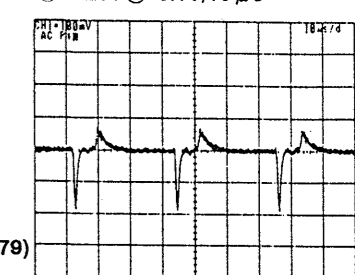

TO MB-701 BOARD CN608 (See page 79)

1	REG +5V
2	GND
3	REG -5V
4	GND
5	POWER MUTE

TO MB-701 BOARD CN601 (See page 79)

1	UNREG +1.6V
2	GND
3	GND
4	UNREG -1.6V

TO FP-709 BOARD CN001 (See page 103)

1	AC 3.1V
2	AC 3.1V
3	GND
4	BC -30V
5	P.CONT
6	EVER 5V
7	GND
8	REG 5V

TO MB-701 BOARD CN603 (See page 79)

1	SP OFF
2	2FH
3	SP ERROR
4	SP UNLOCK

PB	VIDEO SIGNAL			AUDIO SIGNAL
	CHROMA	Y	Y/CHROMA	
→	⇒	⇒⇒	⇒⇒⇒	⇒

SPINDLE PHASE SERVO	⇒⇒
SPINDLE SERVO (SPEED AND PHASE)	⇒⇒⇒
TRACKING SERVO LD/CD/CDV	⇒⇒
SLIDE SERVO LD/CD	⇒⇒
FOCUS SERVO LD/CD	⇒⇒
SKEW SERVO LD TILT	⇒⇒

PS-710 (POWER SUPPLY, SPINDLE SERVO), TR-710 (POWER TRANSFORMER), VS-702 (VOLTAGE SELECTOR) PRINTED WIRING BOARDS

— Ref. No.: PS-710, TR-710, VS-702 Boards; 7,000 series —

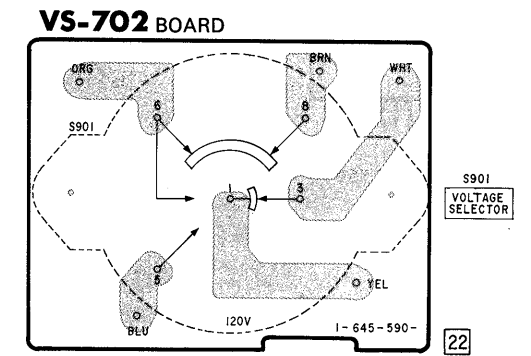
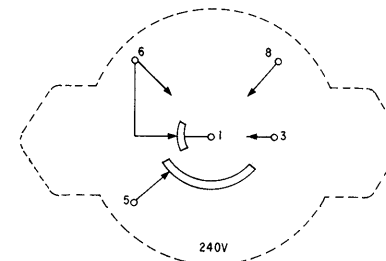
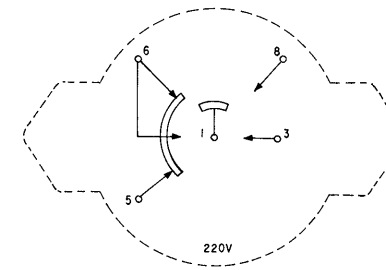
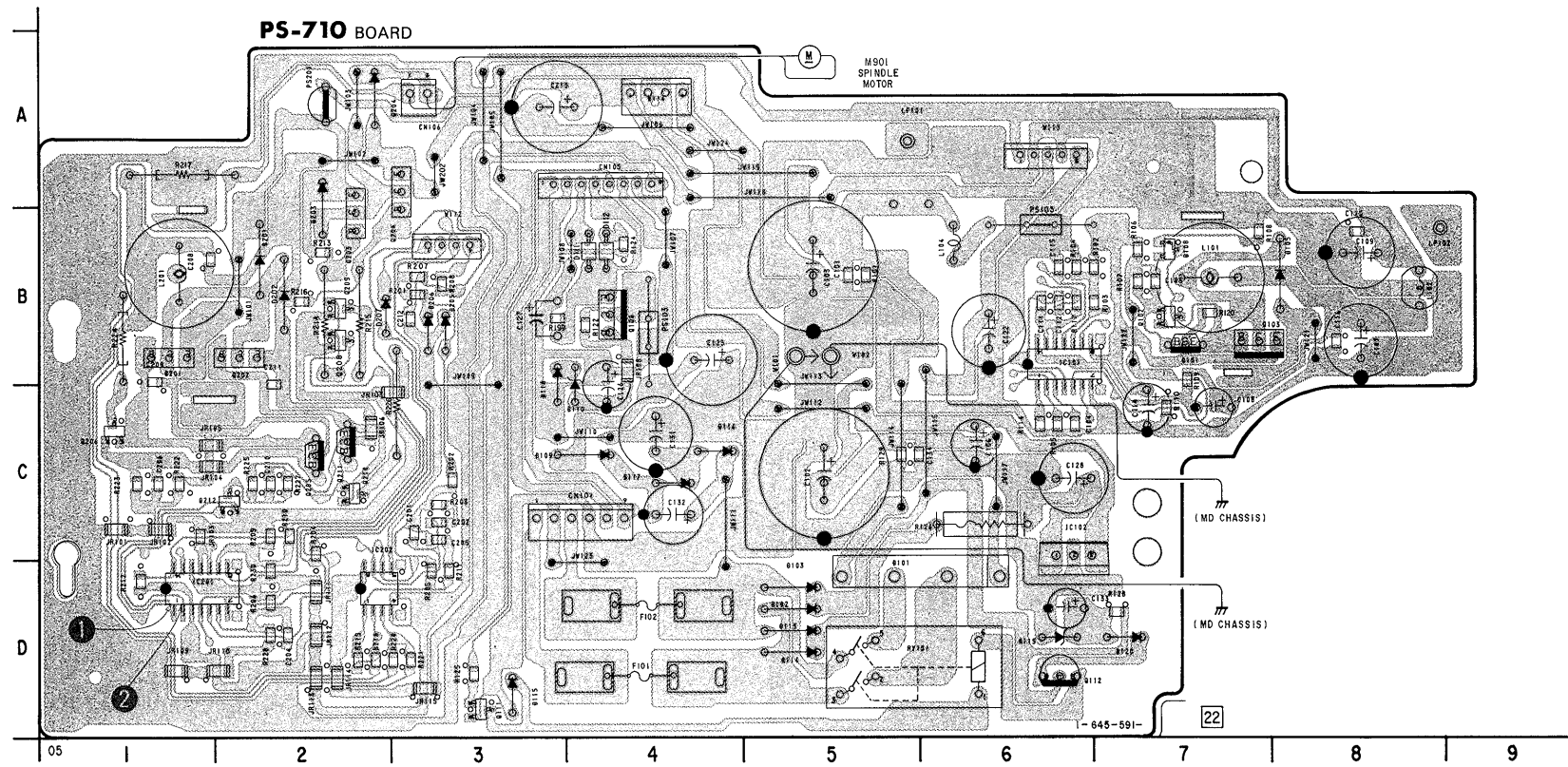

TR-710 BOARD

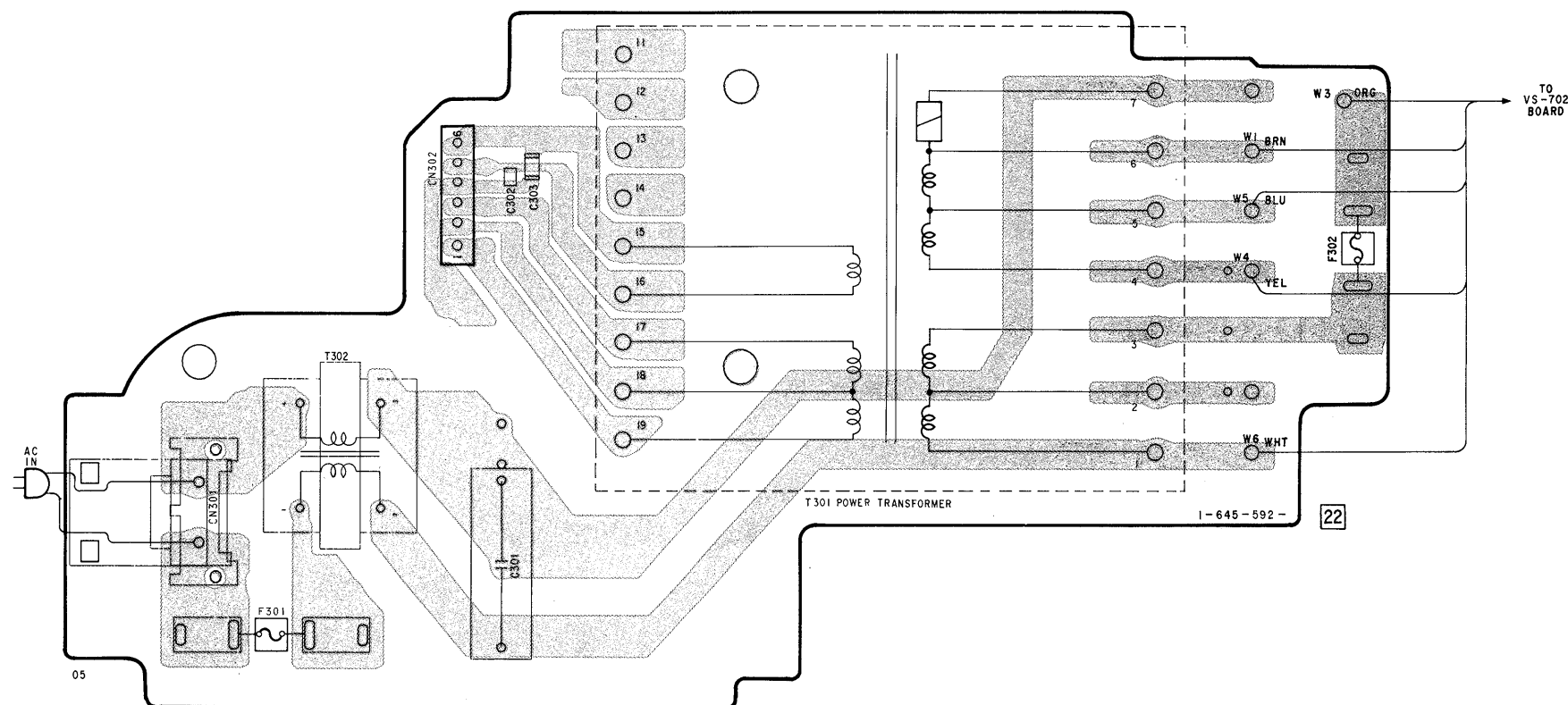

4-3. SEMICONDUCTORS

BA9700AF
LM339NS
MC14066BF

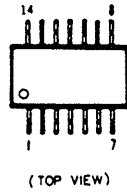

CXD8405Q

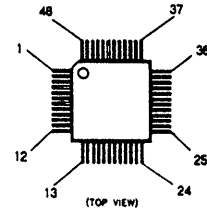

M5218AFP

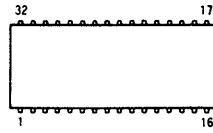

PT360FS



D3SBA10

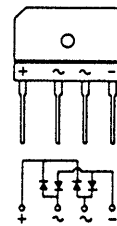

CXA1081M

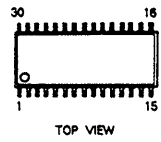

LA6510
TA7291P

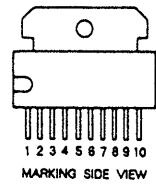

NJM78L08FA



2SA1175-HFE
2SC2785-HFE



FC52M-5

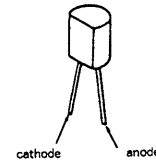

CXA8020Q
CXD8404Q

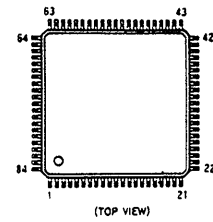

LM324NS
RC4558M
μPC4558G2

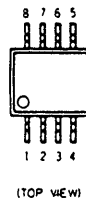

RC79L08A

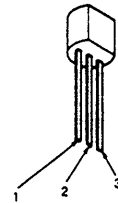

2SB1151-L
2SD1691-K

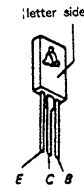

GP-2S09-B

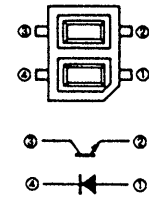

CXD2500AQ
MB89795-137

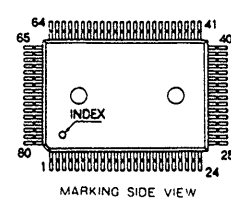

SN74HC367ANS

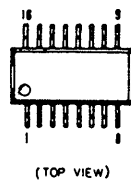

SBX1610-59

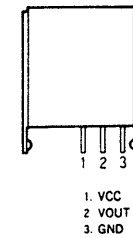

2SB1370-EF
2SD2012

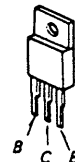

ERA83-006
MTZJ-4.3A
RD3.9ES-B2
RD8.2ES-B1
RD11ES-B2
RD36ES-B2
RD39ES-B2
1SS119
11ES2

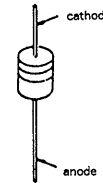

CXD2560M

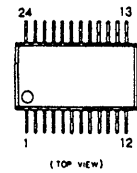

MSM72H051GS-VIK

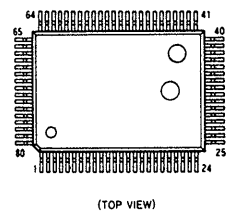

TA7805S
TA79005S

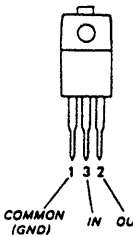

2SB734-34



GL-360

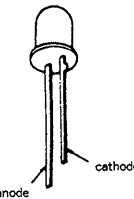

CXD2561BM

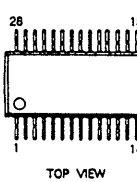

M50455-350FP

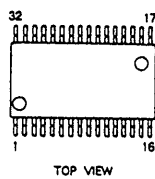

YSS205

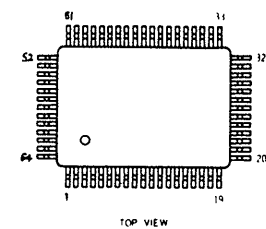

2SC2001-LK
2SD655-E



SLR34DC3
SLR34MC3

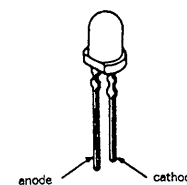

SECTION 5 EXPLODED VIEWS

NOTE:

- XX and -X mean standardized parts, so they may have some difference from the original one.
- Color Indication of Appearance Parts
Example:
KNOB, BALANCE (WHITE) ... (RED)
 ↑ ↑
 Parts Color Cabinet's Color

- Items marked "*" are not stocked since they are seldom required for routine service. Some delay should be anticipated when ordering these items.
- The mechanical parts with no reference number in the exploded views are not supplied.
- Hardware (# mark) list is given in the last of this parts list.

The components identified by mark △ or dotted line with mark △ are critical for safety.
Replace only with part number specified.

5-1. CABINET, FRONT PANEL ASSEMBLIES

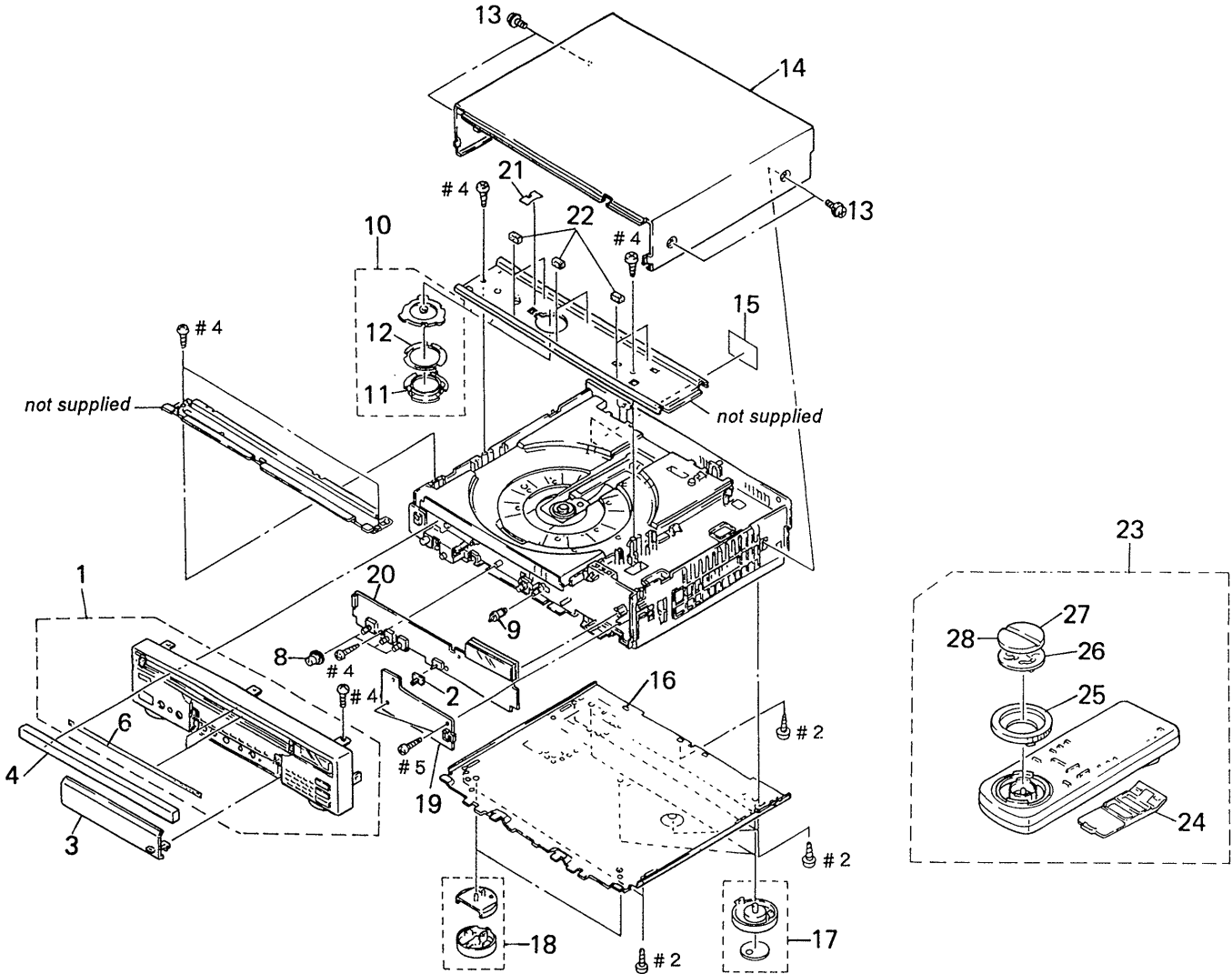

Ref. No.	Part No.	Description	Remark	Ref. No.	Part No.	Description	Remark
1	X-3941-918-1	PANEL ASSY, FRONT		16	X-3942-383-1	PLATE ASSY, BOTTOM	
2	3-949-074-01	KNOB, SLIDE		17	X-3941-457-1	FOOT ASSY	
3	X-3941-919-2	DOOR ASSY		18	X-3941-456-1	FOOT ASSY, FRONT	
4	3-947-258-41	COVER, TRAY		* 19	A-6420-837-A	FP-710 (E62) BOARD, COMPLETE	
6	3-947-248-01	SHEET (2), ACOUSTIC ISOLATION		* 20	A-6421-839-A	FP-709 (E62) BOARD, COMPLETE	
8	3-749-922-11	KNOB		* 21	3-737-454-01	SHEET, HOLDER	
9	A-6415-523-A	KNOB (HP) BLOCK ASSY		22	9-911-842-XX	CUSHION	
10	X-3735-006-1	PLATE ASSY, PRESS		23	1-693-095-61	REMOTE COMMANDER (RMT-16A)	
11	3-735-010-01	PLATE (1), PRESS		24	3-943-535-01	COVER, BATTERY	
12	3-735-011-01	SPRING		25	3-941-618-01	RING, SHUTTLE	
13	3-710-901-41	SCREW, TAPPING		26	3-941-619-01	HOLDER, DIAL	
* 14	3-735-065-11	CASE, UPPER		27	3-941-617-31	BUTTON, PLAYBACK	
* 15	3-949-498-01	LABEL, MODEL NUMBER		28	3-941-618-31	BUTTON, STOP	

5-2. CHASSIS (1)

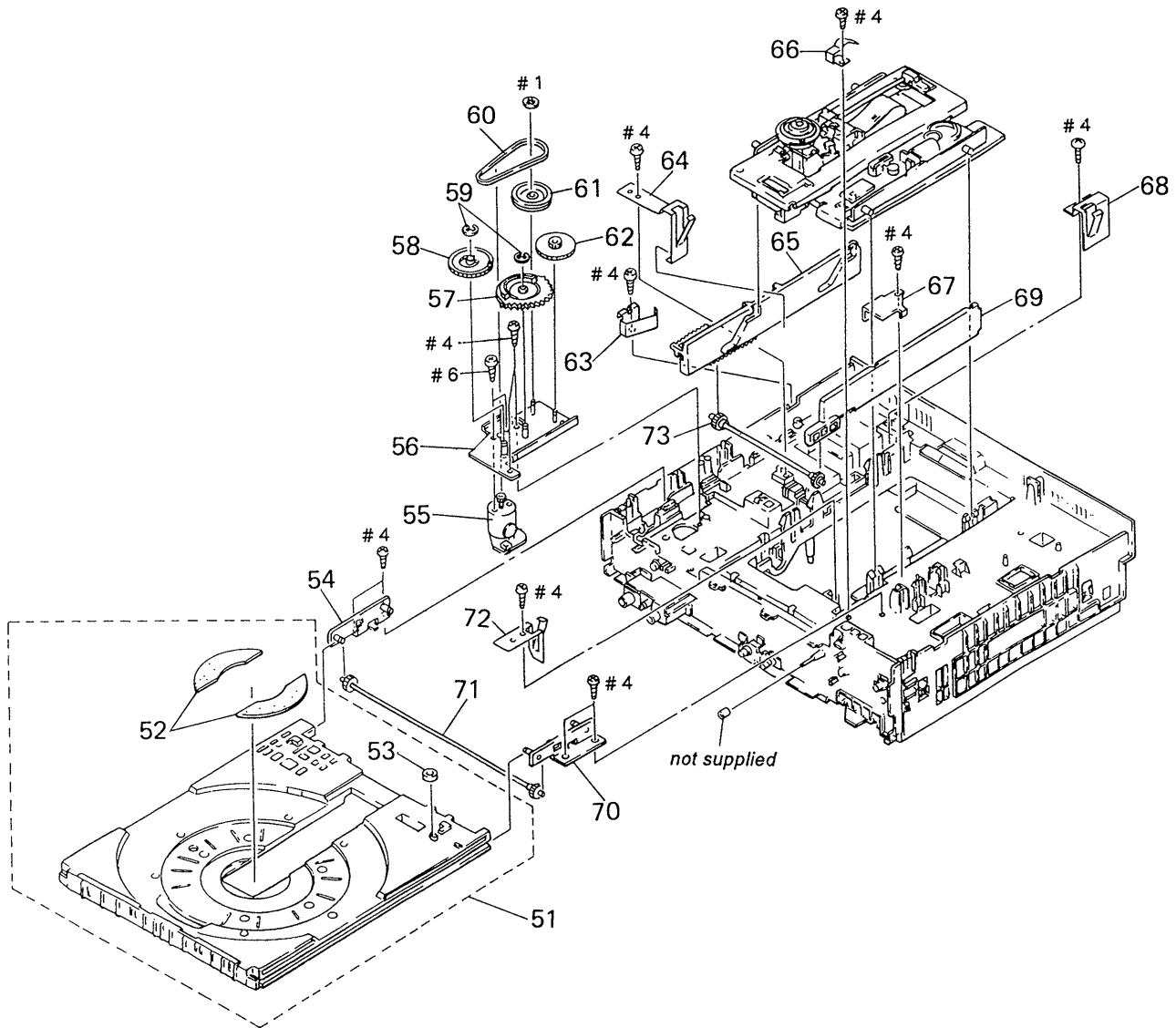

Ref. No.	Part No.	Description	Remark	Ref. No.	Part No.	Description	Remark
51	X-3735-032-2	TRAY ASSY		63	3-948-289-01	SPRING (2), TRAY	
52	3-735-039-03	SHEET, CD		64	3-737-401-01	SPRING (1)	
* 53	4-914-248-01	STOPPER, RUBBER		65	3-735-053-01	RACK (LEFT)	
54	X-3735-071-1	GUIDE ASSY (L), TRAY		66	3-737-448-01	SPRING, LEAF	
55	A-6415-359-A	MOTOR BLOCK ASSY (X), THREADING		* 67	3-749-912-01	RETAINER (B), RACK	
56	X-3941-458-1	THREADING (BASE) ASSY (N)		68	3-947-254-01	SPRING (3), MD RETAINER	
57	3-947-264-01	CAM (N), DRIVING		69	3-735-052-01	RACK (RIGHT)	
58	3-735-035-01	GEAR, TRAY		70	X-3735-070-1	GUIDE ASSY (R), TRAY	
59	3-669-595-00	WASHER (2), STOPPER		71	X-3735-069-1	GEAR ASSY, PHASE	
60	3-949-030-01	BELT, DRIVING		72	3-737-402-01	SPRING (2)	
61	3-735-036-01	PULLEY (A)		73	X-3735-008-1	GEAR ASSY, MD PHASE	
62	3-947-262-01	GEAR (N), MIDWAY					

5-3. CHASSIS (2)

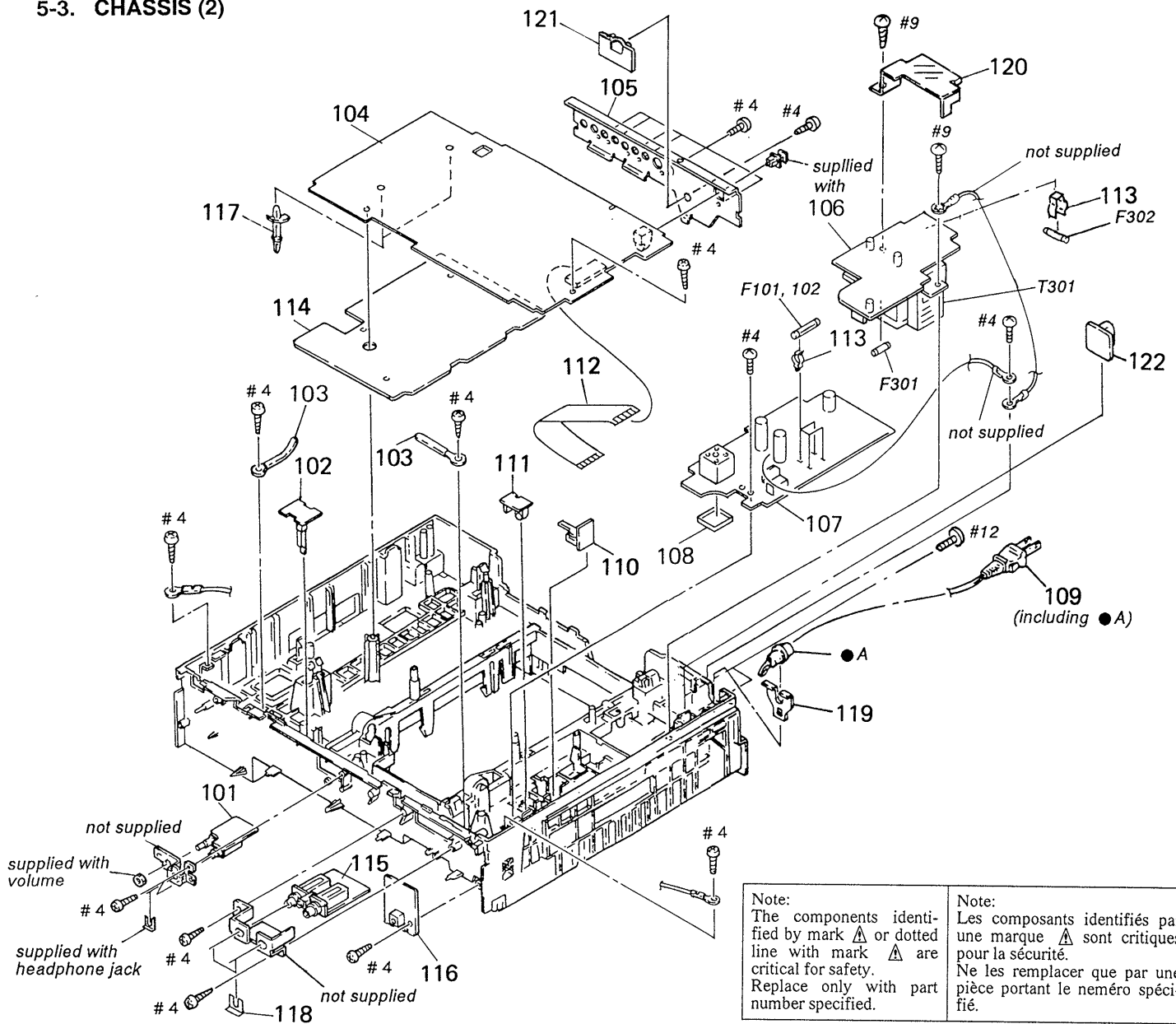

Ref. No.	Part No.	Description	Remark
* 101	1-645-583-11	HP-706 BOARD	
* 102	1-645-588-11	SW-718 BOARD	
103	3-703-150-11	STOPPER, WIRING	
* 104	A-6421-835-A	MB-701 (E62) BOARD, COMPLETE	
105	3-947-255-41	PLATE, JACK, MZ	
* 106	1-645-592-22	TR-710 BOARD	
* 107	A-6421-841-A	PS-710 (E62) BOARD, COMPLETE	
* 108	X-3940-915-1	SHIELD ASSY (2), PS LID	
▲109	1-575-912-21	CORD, POWER	
* 110	1-645-587-11	SW-717 BOARD	
* 111	1-645-589-11	LS-706 BOARD	
* 112	1-696-664-11	WIRE, FLAT (28 CORE)	
▲113	1-533-189-11	HOLDER, FUSE	
* 114	A-6421-836-A	KP-704 (E62) BOARD, COMPLETE	

Ref. No.	Part No.	Description	Remark
* 115	A-6421-838-A	MA-702 (E62) BOARD, COMPLETE	
* 116	1-645-584-11	PW-701 BOARD	
* 117	3-703-353-08	SUPPORTER, PC BOARD	
* 118	3-684-436-01	PLATE, MOUNT	
* 119	3-737-438-01	BRACKET, AC CORD	
120	3-746-543-01	COVER, TRANSFORMER	
* 121	A-6421-861-A	AX-702 (E62) BOARD, COMPLETE	
* 122	A-6426-539-A	VS-702 (E62) BOARD, COMPLETE	
▲F101	1-532-299-00	FUSE, TIME-LAG (5A 250V)	
▲F102	1-532-299-00	FUSE, TIME-LAG (5A 250V)	
▲F301	1-532-285-00	FUSE, TIME-LAG (1.25A 250V)	
▲F302	1-532-284-00	FUSE, TIME-LAG (630mA 250V)	
▲T301	1-450-972-11	TRANSFORMER, POWER	

5-4. MD CHASSIS

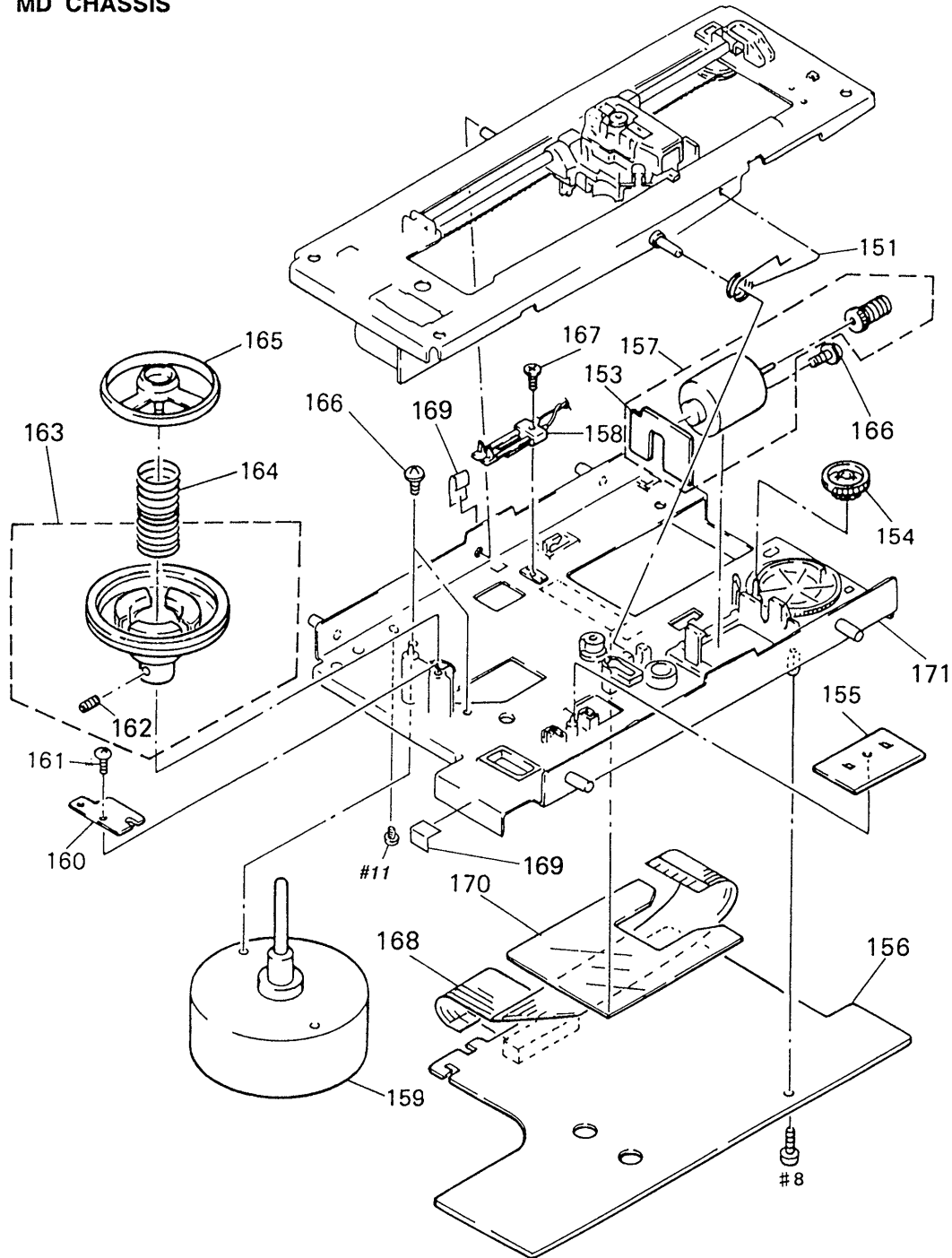

Ref. No.	Part No.	Description	Remark	Ref. No.	Part No.	Description	Remark
151	3-735-021-01	SPRING, TORSION		162	3-701-506-01	SET SCREW, DOUBLE POINT 3X4	
* 153	1-631-095-11	MT-30 BOARD		163	X-3735-003-1	TURNTABLE ASSY	
154	3-735-025-01	GEAR, SKEW		* 164	3-735-026-01	SPRING, COMPRESSION	
* 155	1-635-255-11	CK-44 BOARD		165	X-2625-077-1	GUIDE ASSY, CENTER	
* 156	A-6421-465-A	SV-63 BOARD, COMPLETE		166	4-606-833-01	SCREW (3X5), + PSW	
157	A-6415-290-A	MOTOR BLOCK ASSY, SKEW		167	3-899-248-01	SCREW (M3X6)	
158	1-554-468-00	SWITCH, LEAF		168	1-574-648-11	CABLE, FLEXIBLE FLAT (24 CORE)	
159	1-541-776-21	MOTOR, LD SPINDLE		* 169	3-737-413-01	SHEET, TEFLON	
* 160	1-635-256-11	FG-41 BOARD		* 170	3-735-099-01	SHEET, FLEXIBLE RETAINER	
161	3-719-845-11	SCREW (B2X8), TAPPING		* 171	3-735-068-15	CHASSIS, MD	

5-5. OPTICAL BLOCK

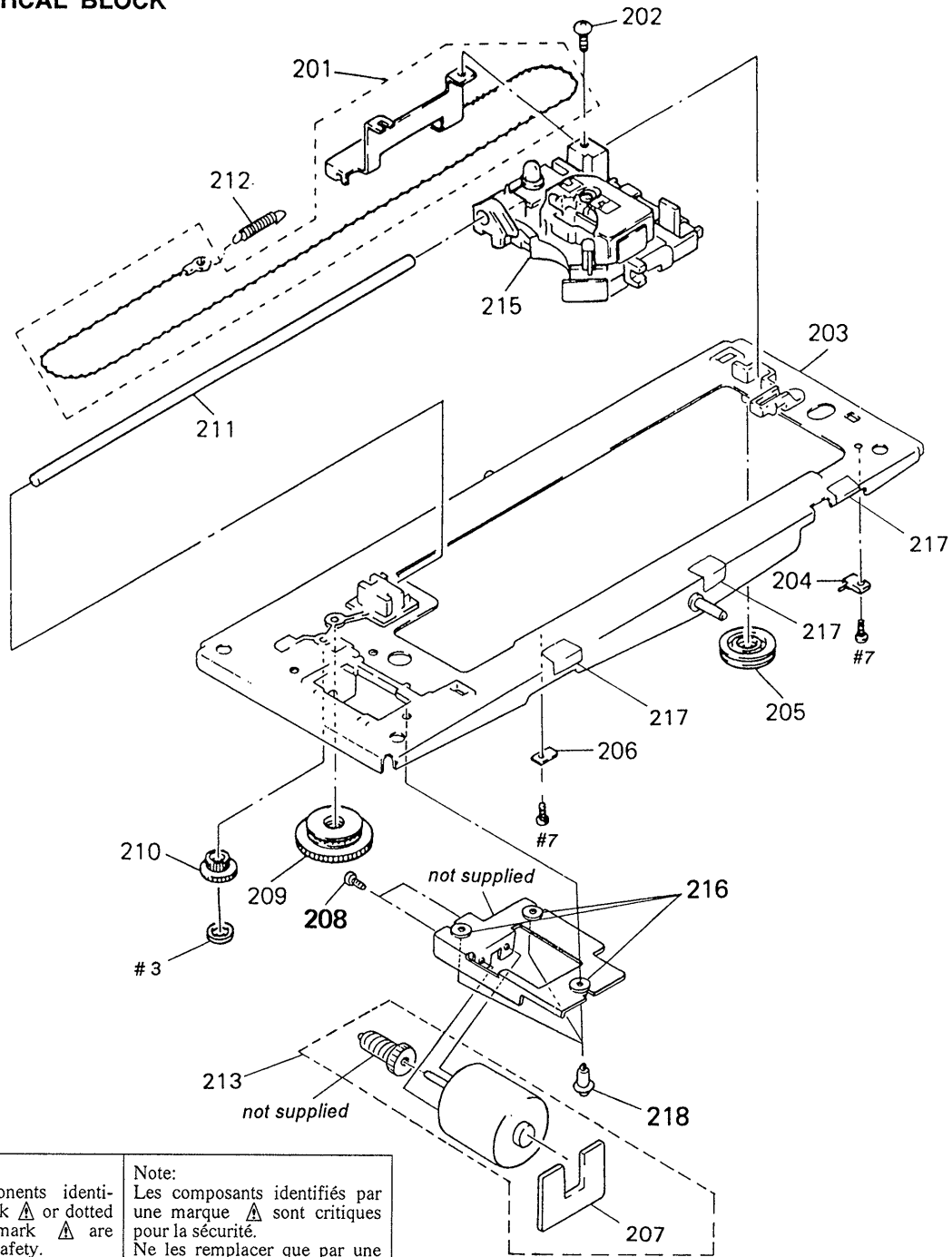

Note:
The components identified by mark ▲ or dotted line with mark ▲ are critical for safety. Replace only with part number specified.

Note:
Les composants identifiés par une marque ▲ sont critiques pour la sécurité. Ne les remplacer que par une pièce portant le numéro spécifié.

Ref. No.	Part No.	Description	Remark	Ref. No.	Part No.	Description	Remark
201	X-3735-001-1	WIRE ASSY		210	3-735-015-01	GEAR, CARRIAGE	
202	3-899-248-01	SCREW (M3X6)		* 211	3-735-020-01	SHAFT, CARRIAGE	
* 203	X-3940-657-1	CHASSIS ASSY		212	3-672-430-00	SPRING, TENSION	
204	1-570-771-21	SWITCH		213	A-6415-434-A	MOTOR BLOCK ASSY, SLED (M902)	
205	3-735-017-01	PULLEY, RETURN		▲215	8-848-138-11	DEVICE, OPTICAL KHS-130A	
206	1-571-435-11	SWITCH		216	3-570-118-00	CUSHION, MOTOR	
* 207	1-630-097-11	MT-28 BOARD		217	3-846-312-00	SPACER	
208	3-949-324-01	SCREW (3X4), +PSW		218	3-570-027-00	SCREW, MOTOR	
209	3-735-016-01	PULLEY, DRIVING					

SECTION 6 ELECTRICAL PARTS LIST

AX-702

CK-44

FG-41

FP-709

NOTE:

- Due to standardization, replacements in the parts list may be different from the parts specified in the diagrams or the components used on the set.
- -XX and -X mean standardized parts, so they may have some difference from the original one.
- RESISTORS
All resistors are in ohms.
METAL: Metal-film resistor.
METAL OXIDE: Metal oxide-film resistor.
F: nonflammable

- Items marked "*" are not stocked since they are seldom required for routine service. Some delay should be anticipated when ordering these items.
- SEMICONDUCTORS
In each case, u: μ , for example:
uA ..: μ A.. uPA..: μ PA..
uPB..: μ PB.. uPC..: μ PC.. uPD..: μ PD..
- CAPACITORS
uF: μ F
- COILS
uH: μ H

The components identified by mark Δ or dotted line with mark Δ are critical for safety. Replace only with part number specified.

When indicating parts by reference number, please include the board.

Ref. No.	Part No.	Description	Remark
*	A-6421-861-A	AX-702 (E62) BOARD, COMPLETE *****	
*	1-645-586-11	AX-702 BOARD	
		< CAPACITOR >	
C501	1-124-927-11	ELECT 4.7uF 20% 100V	
C502	1-124-589-11	ELECT 47uF 20% 16V	
C503	1-124-589-11	ELECT 47uF 20% 16V	
C504	1-124-927-11	ELECT 4.7uF 20% 100V	
		< CONNECTOR >	
CN501	1-506-485-11	PIN, CONNECTOR 6P	
		< IC >	
IC501	8-759-996-43	IC RC4558PS	
		< JACK >	
J501	1-695-495-11	JACK, PIN 2P (AUX L/R)	
		< RESISTOR >	
R501	1-216-049-00	METAL CHIP 1K 5% 1/10W	
R502	1-216-049-00	METAL CHIP 1K 5% 1/10W	
R503	1-216-089-00	METAL CHIP 47K 5% 1/10W	
R504	1-216-089-00	METAL CHIP 47K 5% 1/10W	
R505	1-216-049-00	METAL CHIP 1K 5% 1/10W	
R506	1-216-049-00	METAL CHIP 1K 5% 1/10W	

*	1-635-255-11	CK-44 BOARD *****	
		< CAPACITOR >	
C401	1-163-038-00	CERAMIC CHIP 0.1uF 25V	
C402	1-163-038-00	CERAMIC CHIP 0.1uF 25V	
		< CONNECTOR >	
CN401	1-506-467-11	PIN, CONNECTOR 2P	
CN402	1-506-468-11	PIN, CONNECTOR 3P	

Ref. No.	Part No.	Description	Remark
CN403	1-506-467-11	PIN, CONNECTOR 2P	
CN404	1-506-467-11	PIN, CONNECTOR 2P	
CN405	1-506-467-11	PIN, CONNECTOR 2P	
		< JUMPER RESISTOR >	
JR401	1-216-295-00	METAL CHIP 0 5% 1/10W	
JR402	1-216-296-00	METAL CHIP 0 5% 1/8W	
		< RESISTOR >	
R401	1-216-077-00	METAL CHIP 15K 5% 1/10W	
R402	1-216-031-00	METAL CHIP 180 5% 1/10W	
R403	1-216-061-00	METAL CHIP 3.3K 5% 1/10W	
R404	1-216-001-00	METAL CHIP 10 5% 1/10W	
R405	1-216-001-00	METAL CHIP 10 5% 1/10W	
R406	1-216-031-00	METAL CHIP 180 5% 1/10W	
R407	1-216-061-00	METAL CHIP 3.3K 5% 1/10W	

*	1-635-256-11	FG-41 BOARD *****	
		< DIODE >	
D301	8-719-939-11	DIODE GP-2S09-B	

*	A-6421-839-A	FP-709 (E62) BOARD, COMPLETE *****	
		< CAPACITOR >	
C001	1-164-232-11	CERAMIC CHIP 0.01uF 50V	
C002	1-126-157-11	ELECT 10uF 20% 16V	
C003	1-164-232-11	CERAMIC CHIP 0.01uF 50V	
C004	1-126-157-11	ELECT 10uF 20% 16V	
C005	1-164-232-11	CERAMIC CHIP 0.01uF 50V	
C006	1-164-232-11	CERAMIC CHIP 0.01uF 50V	
C007	1-163-135-00	CERAMIC CHIP 560PF 5% 50V	
C008	1-124-584-00	ELECT 100uF 20% 10V	
C009	1-124-584-00	ELECT 100uF 20% 10V	
C010	1-163-141-00	CERAMIC CHIP 0.001uF 5% 50V	
C011	1-163-141-00	CERAMIC CHIP 0.001uF 5% 50V	

Ref. No.	Part No.	Description	Remark		
C012	1-164-232-11	CERAMIC CHIP 0.01uF	50V		
C013	1-164-232-11	CERAMIC CHIP 0.01uF	50V		
C014	1-163-141-00	CERAMIC CHIP 0.001uF	5%	50V	
C015	1-163-141-00	CERAMIC CHIP 0.001uF	5%	50V	
C016	1-163-141-00	CERAMIC CHIP 0.001uF	5%	50V	
C017	1-163-141-00	CERAMIC CHIP 0.001uF	5%	50V	
C018	1-163-141-00	CERAMIC CHIP 0.001uF	5%	50V	
C019	1-163-141-00	CERAMIC CHIP 0.001uF	5%	50V	
C020	1-163-141-00	CERAMIC CHIP 0.001uF	5%	50V	
C021	1-163-141-00	CERAMIC CHIP 0.001uF	5%	50V	
< CONNECTOR >					
CN001	1-506-487-11	PIN, CONNECTOR 8P			
CN002	1-506-491-11	PIN, CONNECTOR 12P			
CN003	1-506-488-11	PIN, CONNECTOR 9P			
CN004	1-506-484-11	PIN, CONNECTOR 5P			
CN005	1-506-473-11	PIN, CONNECTOR 8P			
CN006	1-506-482-11	PIN, CONNECTOR 3P			
CN007	1-569-339-11	CONNECTOR, BOARD TO BOARD 7P			
< DIODE >					
D001	8-719-400-18	DIODE MA152WK			
D002	8-719-940-82	LED SLR34MC3 (DIGITAL SOUND)			
D003	8-719-946-30	LED SLR34DC3 (KARAOKE PON)			
D004	8-719-946-30	LED SLR34DC3 (ONTA)			
D005	8-719-946-30	LED SLR34DC3 (VOCAL)			
D006	8-719-946-30	LED SLR34DC3 (DOWN)			
D007	8-719-940-82	LED SLR34MC3 (NATURAL)			
D008	8-719-946-30	LED SLR34DC3 (UP)			
D009	8-719-946-30	LED SLR34DC3 (AUTO PAUSE)			
D010	8-719-946-30	LED SLR34DC3 (RESERVE)			
D013	8-719-946-30	LED SLR34DC3 (SIMULATED)			
D014	8-719-946-30	LED SLR34DC3 (KARAOKE BAR)			
D015	8-719-946-30	LED SLR34DC3 (MOVIE)			
< IC >					
IC001	8-752-838-17	IC CXP50116-409Q			
IC002	8-759-074-40	IC PST572DMT-T1			
IC003	8-759-636-55	IC M5218AFP			
< JUMPER RESISTOR >					
JR001	1-216-295-00	METAL CHIP 0	5%	1/10W	
JR002	1-216-295-00	METAL CHIP 0	5%	1/10W	
< COIL >					
L001	1-410-521-11	INDUCTOR 100uH			

Ref. No.	Part No.	Description	Remark		
< FLUORESCENT INDICATOR >					
ND001	1-519-652-21	INDICATOR TUBE, FLUORESCENT			
< TRANSISTOR >					
Q001	8-729-901-01	TRANSISTOR DTC144EK			
Q002	8-729-901-01	TRANSISTOR DTC144EK			
Q003	8-729-901-06	TRANSISTOR DTA144EK			
Q004	8-729-900-51	TRANSISTOR DTA114TK			
Q005	8-729-900-51	TRANSISTOR DTA114TK			
Q006	8-729-900-51	TRANSISTOR DTA114TK			
Q007	8-729-900-51	TRANSISTOR DTA114TK			
Q008	8-729-900-51	TRANSISTOR DTA114TK			
Q009	8-729-900-51	TRANSISTOR DTA114TK			
Q010	8-729-902-99	TRANSISTOR DTC114TK			
Q011	8-729-902-99	TRANSISTOR DTC114TK			
Q012	8-729-902-99	TRANSISTOR DTC114TK			
Q015	8-729-902-99	TRANSISTOR DTC114TK			
Q016	8-729-902-99	TRANSISTOR DTC114TK			
Q017	8-729-902-99	TRANSISTOR DTC114TK			
< RESISTOR >					
R001	1-216-121-00	METAL CHIP 1M	5%	1/10W	
R005	1-216-073-00	METAL CHIP 10K	5%	1/10W	
R006	1-216-073-00	METAL CHIP 10K	5%	1/10W	
R007	1-216-073-00	METAL CHIP 10K	5%	1/10W	
R008	1-216-057-00	METAL CHIP 2.2K	5%	1/10W	
R009	1-216-049-00	METAL CHIP 1K	5%	1/10W	
R010	1-216-073-00	METAL CHIP 10K	5%	1/10W	
R011	1-216-025-00	METAL CHIP 100	5%	1/10W	
R012	1-216-049-00	METAL CHIP 1K	5%	1/10W	
R013	1-216-033-00	METAL CHIP 220	5%	1/10W	
R014	1-216-033-00	METAL CHIP 220	5%	1/10W	
R015	1-216-033-00	METAL CHIP 220	5%	1/10W	
R016	1-216-033-00	METAL CHIP 220	5%	1/10W	
R017	1-216-033-00	METAL CHIP 220	5%	1/10W	
R018	1-216-033-00	METAL CHIP 220	5%	1/10W	
R019	1-216-033-00	METAL CHIP 220	5%	1/10W	
R020	1-216-033-00	METAL CHIP 220	5%	1/10W	
R021	1-216-033-00	METAL CHIP 220	5%	1/10W	
R024	1-216-033-00	METAL CHIP 220	5%	1/10W	
R025	1-216-033-00	METAL CHIP 220	5%	1/10W	
R026	1-216-033-00	METAL CHIP 220	5%	1/10W	
R027	1-216-073-00	METAL CHIP 10K	5%	1/10W	
R028	1-216-073-00	METAL CHIP 10K	5%	1/10W	
R029	1-216-073-00	METAL CHIP 10K	5%	1/10W	
R030	1-216-073-00	METAL CHIP 10K	5%	1/10W	
R031	1-216-073-00	METAL CHIP 10K	5%	1/10W	
R032	1-216-073-00	METAL CHIP 10K	5%	1/10W	

Ref. No.	Part No.	Description			Remark
R033	1-216-073-00	METAL CHIP	10K	5%	1/10W
R034	1-216-049-00	METAL CHIP	1K	5%	1/10W
R035	1-216-073-00	METAL CHIP	10K	5%	1/10W
R036	1-216-073-00	METAL CHIP	10K	5%	1/10W
R037	1-216-073-00	METAL CHIP	10K	5%	1/10W
R038	1-216-073-00	METAL CHIP	10K	5%	1/10W
R039	1-216-073-00	METAL CHIP	10K	5%	1/10W
R040	1-216-073-00	METAL CHIP	10K	5%	1/10W
R041	1-216-025-00	METAL CHIP	100	5%	1/10W
R042	1-216-079-00	METAL CHIP	18K	5%	1/10W
R043	1-216-069-00	METAL CHIP	6.8K	5%	1/10W
R044	1-216-063-00	METAL CHIP	3.9K	5%	1/10W
R045	1-216-059-00	METAL CHIP	2.7K	5%	1/10W
R046	1-216-079-00	METAL CHIP	18K	5%	1/10W
R047	1-216-069-00	METAL CHIP	6.8K	5%	1/10W
R048	1-216-063-00	METAL CHIP	3.9K	5%	1/10W
R049	1-216-059-00	METAL CHIP	2.7K	5%	1/10W
R050	1-216-081-00	METAL CHIP	22K	5%	1/10W
R051	1-216-049-00	METAL CHIP	1K	5%	1/10W
R052	1-216-049-00	METAL CHIP	1K	5%	1/10W
R053	1-216-049-00	METAL CHIP	1K	5%	1/10W
R054	1-216-049-00	METAL CHIP	1K	5%	1/10W
R055	1-216-049-00	METAL CHIP	1K	5%	1/10W
R058	1-216-073-00	METAL CHIP	10K	5%	1/10W
R059	1-216-025-00	METAL CHIP	100	5%	1/10W
R060	1-216-025-00	METAL CHIP	100	5%	1/10W
R061	1-216-025-00	METAL CHIP	100	5%	1/10W
R062	1-216-025-00	METAL CHIP	100	5%	1/10W
R063	1-216-025-00	METAL CHIP	100	5%	1/10W
R064	1-216-025-00	METAL CHIP	100	5%	1/10W
R065	1-216-033-00	METAL CHIP	220	5%	1/10W
R066	1-249-409-11	CARBON	220	5%	1/4W F
< VARIABLE RESISTOR >					
RV001	1-241-238-21	RES, VAR, CARBON 20K (MIC 1)			
RV002	1-241-238-21	RES, VAR, CARBON 20K (MIC 2)			
RV003	1-241-238-21	RES, VAR, CARBON 20K (DIGITAL ECHO)			
< SWITCH >					
S001	1-572-946-11	SWITCH, TACTIL (RESET)			
S002	1-572-946-11	SWITCH, TACTIL (KARAOKE PON)			
S003	1-572-946-11	SWITCH, TACTIL (ONTA)			
S004	1-572-946-11	SWITCH, TACTIL (VOCAL)			
S005	1-572-946-11	SWITCH, TACTIL (DOWN)			
S006	1-572-946-11	SWITCH, TACTIL (NATURAL)			
S007	1-572-946-11	SWITCH, TACTIL (UP)			
S008	1-572-946-11	SWITCH, TACTIL (AUTO PAUSE)			
S009	1-572-946-11	SWITCH, TACTIL (RESERVE)			
S010	1-572-946-11	SWITCH, TACTIL (SURROUND)			

Ref. No.	Part No.	Description			Remark
S011	1-572-908-11	SWITCH, SLIDE (MODE)			
S012	1-572-908-11	SWITCH, SLIDE (INPUT SELECTOR)			
< VIBRATOR >					
X001	1-577-359-21	VIBRATOR, CERAMIC (4.19MHz)			

*	A-6421-837-A	FP-710 (E62) BOARD, COMPLETE			

< CAPACITOR >					
C201	1-163-141-00	CERAMIC CHIP	0.001uF	5%	50V
C202	1-163-141-00	CERAMIC CHIP	0.001uF	5%	50V
C203	1-163-141-00	CERAMIC CHIP	0.001uF	5%	50V
C204	1-163-141-00	CERAMIC CHIP	0.001uF	5%	50V
C205	1-163-141-00	CERAMIC CHIP	0.001uF	5%	50V
< CONNECTOR >					
CN201	1-569-336-11	CONNECTOR, BOARD TO BOARD 7P			
< RESISTOR >					
R201	1-216-079-00	METAL CHIP	18K	5%	1/10W
R202	1-216-069-00	METAL CHIP	6.8K	5%	1/10W
R203	1-216-063-00	METAL CHIP	3.9K	5%	1/10W
R204	1-216-059-00	METAL CHIP	2.7K	5%	1/10W
R205	1-216-079-00	METAL CHIP	18K	5%	1/10W
R206	1-216-069-00	METAL CHIP	6.8K	5%	1/10W
R207	1-216-063-00	METAL CHIP	3.9K	5%	1/10W
R208	1-216-059-00	METAL CHIP	2.7K	5%	1/10W
R209	1-216-079-00	METAL CHIP	18K	5%	1/10W
R210	1-216-069-00	METAL CHIP	6.8K	5%	1/10W
R211	1-216-063-00	METAL CHIP	3.9K	5%	1/10W
R212	1-216-059-00	METAL CHIP	2.7K	5%	1/10W
R213	1-216-069-00	METAL CHIP	6.8K	5%	1/10W
R214	1-216-063-00	METAL CHIP	3.9K	5%	1/10W
R215	1-216-059-00	METAL CHIP	2.7K	5%	1/10W
R216	1-216-079-00	METAL CHIP	18K	5%	1/10W
R217	1-216-069-00	METAL CHIP	6.8K	5%	1/10W
R218	1-216-063-00	METAL CHIP	3.9K	5%	1/10W
R219	1-216-059-00	METAL CHIP	2.7K	5%	1/10W
R220	1-216-025-00	METAL CHIP	100	5%	1/10W
R221	1-249-405-11	CARBON	100	5%	1/4W F
R222	1-249-405-11	CARBON	100	5%	1/4W F
R223	1-249-405-11	CARBON	100	5%	1/4W F
R224	1-216-025-00	METAL CHIP	100	5%	1/10W
< SWITCH >					
S201	1-572-946-11	SWITCH, TACTIL (1)			
S202	1-572-946-11	SWITCH, TACTIL (2)			

Ref. No.	Part No.	Description	Remark
S203	1-572-946-11	SWITCH, TACTIL (3)	
S204	1-572-946-11	SWITCH, TACTIL (4)	
S205	1-572-946-11	SWITCH, TACTIL (5)	
S206	1-572-946-11	SWITCH, TACTIL (6)	
S207	1-572-946-11	SWITCH, TACTIL (7)	
S208	1-572-946-11	SWITCH, TACTIL (8)	
S209	1-572-946-11	SWITCH, TACTIL (9)	
S210	1-572-946-11	SWITCH, TACTIL (10)	
S211	1-572-946-11	SWITCH, TACTIL (11)	
S212	1-572-946-11	SWITCH, TACTIL (12)	
S213	1-572-946-11	SWITCH, TACTIL (13)	
S214	1-572-946-11	SWITCH, TACTIL (14)	
S215	1-572-946-11	SWITCH, TACTIL (15)	
S216	1-572-946-11	SWITCH, TACTIL (+10)	
S217	1-572-946-11	SWITCH, TACTIL (0)	
S218	1-572-946-11	SWITCH, TACTIL (◀)	
S219	1-572-946-11	SWITCH, TACTIL (▶)	
S220	1-572-946-11	SWITCH, TACTIL (OPEN/CLOSE ☒)	
S221	1-572-946-11	SWITCH, TACTIL (▷)	
S222	1-572-946-11	SWITCH, TACTIL (■)	
S223	1-572-946-11	SWITCH, TACTIL (▨)	

*	1-645-583-11	HP-706 BOARD	

		< CAPACITOR >	
C403	1-163-033-00	CERAMIC CHIP 0.022uF	50V
		< CONNECTOR >	
CN401	1-506-482-11	PIN, CONNECTOR 3P	
		< JACK >	
J401	1-507-796-71	JACK (PHONES)	
		< RESISTOR >	
R401	1-216-057-00	METAL CHIP 2.2K 5%	1/10W
R402	1-216-013-00	METAL CHIP 33 5%	1/10W
R403	1-216-013-00	METAL CHIP 33 5%	1/10W
R404	1-216-057-00	METAL CHIP 2.2K 5%	1/10W
		< VARIABLE RESISTOR >	
RV401	1-241-139-11	RES, VAR, CARBON 500/500 (PHONES LEVEL)	

Ref. No.	Part No.	Description	Remark
*	A-6421-836-A	KP-704 (E62) BOARD, COMPLETE	

		< CAPACITOR >	
C601	1-124-589-11	ELECT 47uF	20% 16V
C602	1-163-038-00	CERAMIC CHIP 0.1uF	25V
C603	1-124-589-11	ELECT 47uF	20% 16V
C604	1-124-589-11	ELECT 47uF	20% 16V
C605	1-126-163-11	ELECT 4.7uF	20% 50V
C606	1-124-589-11	ELECT 47uF	20% 16V
C607	1-126-163-11	ELECT 4.7uF	20% 50V
C608	1-124-589-11	ELECT 47uF	20% 16V
C609	1-163-006-11	CERAMIC CHIP 560PF	10% 50V
C610	1-163-019-00	CERAMIC CHIP 0.0068uF	10% 50V
C611	1-126-163-11	ELECT 4.7uF	20% 50V
C612	1-126-163-11	ELECT 4.7uF	20% 50V
C613	1-124-584-00	ELECT 100uF	20% 10V
C614	1-163-012-00	CERAMIC CHIP 0.0018uF	10% 50V
C615	1-124-589-11	ELECT 47uF	20% 16V
C616	1-126-163-11	ELECT 4.7uF	20% 50V
C617	1-126-163-11	ELECT 4.7uF	20% 50V
C618	1-126-917-11	ELECT 330uF	20% 6.3V
C619	1-163-038-00	CERAMIC CHIP 0.1uF	25V
C620	1-124-589-11	ELECT 47uF	20% 16V
C621	1-137-564-91	FILM 0.0033uF	5% 50V
C622	1-137-564-91	FILM 0.0033uF	5% 50V
C623	1-124-589-11	ELECT 47uF	20% 16V
C624	1-163-038-00	CERAMIC CHIP 0.1uF	25V
C625	1-124-584-00	ELECT 100uF	20% 10V
C626	1-137-564-91	FILM 0.0033uF	5% 50V
C627	1-124-589-11	ELECT 47uF	20% 16V
C628	1-124-261-00	ELECT 10uF	20% 50V
C629	1-126-163-11	ELECT 4.7uF	20% 50V
C630	1-163-012-00	CERAMIC CHIP 0.0018uF	10% 50V
C631	1-163-033-00	CERAMIC CHIP 0.022uF	50V
C632	1-163-033-00	CERAMIC CHIP 0.022uF	50V
C633	1-124-261-00	ELECT 10uF	20% 50V
C634	1-126-163-11	ELECT 4.7uF	20% 50V
C635	1-163-012-00	CERAMIC CHIP 0.0018uF	10% 50V
C636	1-124-589-11	ELECT 47uF	20% 16V
C637	1-163-038-00	CERAMIC CHIP 0.1uF	25V
C638	1-124-589-11	ELECT 47uF	20% 16V
C639	1-124-584-00	ELECT 100uF	20% 10V
C640	1-124-584-00	ELECT 100uF	20% 10V
		< CONNECTOR >	
CN601	1-506-468-11	PIN, CONNECTOR 3P	
CN603	1-573-124-11	CONNECTOR, BOARD TO BOARD 15P	
CN604	1-506-474-11	PIN, CONNECTOR 9P	

KP-704

Ref. No.	Part No.	Description	Remark
< DIODE >			
D601	8-719-982-10	DIODE MTZJ-4.3A	
D602	8-719-982-10	DIODE MTZJ-4.3A	
D603	8-719-800-76	DIODE 1SS226	
D604	8-719-800-76	DIODE 1SS226	
D605	8-719-800-76	DIODE 1SS226	
D606	8-719-104-34	DIODE 1S2836	
< FILTER >			
FL601	1-236-071-11	ENCAPSULATED COMPONENT	
FL602	1-236-071-11	ENCAPSULATED COMPONENT	
FL603	1-239-201-11	FILTER, LOW PASS	
FL604	1-239-201-11	FILTER, LOW PASS	
FL605	1-236-071-11	ENCAPSULATED COMPONENT	
FL606	1-236-071-11	ENCAPSULATED COMPONENT	
< IC >			
IC601	8-752-838-37	IC CXP5084	
IC602	8-759-636-55	IC M5218AFP	
IC603	8-759-504-52	IC YSS205	
IC604	8-759-926-64	IC SN74HC367ANS	
IC605	8-759-300-71	IC HD14053BFP	
IC606	8-759-636-55	IC M5218AFP	
IC607	8-759-243-37	IC TC51832SPL-10	
IC608	8-759-636-55	IC M5218AFP	
< JUMPER RESISTOR >			
JR601	1-216-295-00	METAL CHIP 0 5%	1/10W
JR602	1-216-296-00	METAL CHIP 0 5%	1/8W
JR604	1-216-296-00	METAL CHIP 0 5%	1/8W
JR605	1-216-295-00	METAL CHIP 0 5%	1/10W
< COIL >			
L601	1-410-509-11	INDUCTOR 10uH	
L602	1-410-501-11	INDUCTOR 2.2uH	
< TRANSISTOR >			
Q601	8-729-901-01	TRANSISTOR DTC144EK	
< RESISTOR >			
R601	1-216-097-00	METAL CHIP 100K 5%	1/10W
R602	1-216-121-00	METAL CHIP 1M 5%	1/10W
R603	1-216-025-00	METAL CHIP 100 5%	1/10W
R604	1-216-025-00	METAL CHIP 100 5%	1/10W
R605	1-216-025-00	METAL CHIP 100 5%	1/10W
R606	1-216-025-00	METAL CHIP 100 5%	1/10W
R607	1-216-025-00	METAL CHIP 100 5%	1/10W

Ref. No.	Part No.	Description	Remark
R608	1-216-025-00	METAL CHIP 100 5%	1/10W
R609	1-216-057-00	METAL CHIP 2.2K 5%	1/10W
R610	1-216-097-00	METAL CHIP 100K 5%	1/10W
R612	1-216-097-00	METAL CHIP 100K 5%	1/10W
R613	1-216-097-00	METAL CHIP 100K 5%	1/10W
R614	1-216-097-00	METAL CHIP 100K 5%	1/10W
R615	1-216-097-00	METAL CHIP 100K 5%	1/10W
R616	1-216-097-00	METAL CHIP 100K 5%	1/10W
R617	1-216-089-00	METAL CHIP 47K 5%	1/10W
R618	1-216-097-00	METAL CHIP 100K 5%	1/10W
R619	1-216-105-00	METAL CHIP 220K 5%	1/10W
R620	1-216-105-00	METAL CHIP 220K 5%	1/10W
R621	1-216-689-11	METAL CHIP 39K 0.5%	1/10W
R622	1-216-073-00	METAL CHIP 10K 5%	1/10W
R623	1-216-073-00	METAL CHIP 10K 5%	1/10W
R624	1-216-097-00	METAL CHIP 100K 5%	1/10W
R625	1-216-105-00	METAL CHIP 220K 5%	1/10W
R626	1-216-105-00	METAL CHIP 220K 5%	1/10W
R627	1-216-105-00	METAL CHIP 220K 5%	1/10W
R628	1-216-105-00	METAL CHIP 220K 5%	1/10W
R629	1-216-105-00	METAL CHIP 220K 5%	1/10W
R630	1-216-105-00	METAL CHIP 220K 5%	1/10W
R631	1-216-061-00	METAL CHIP 3.3K 5%	1/10W
R632	1-216-097-00	METAL CHIP 100K 5%	1/10W
R633	1-216-105-00	METAL CHIP 220K 5%	1/10W
R634	1-216-073-00	METAL CHIP 10K 5%	1/10W
R635	1-216-053-00	METAL CHIP 1.5K 5%	1/10W
R636	1-216-025-00	METAL CHIP 100 5%	1/10W
R637	1-216-025-00	METAL CHIP 100 5%	1/10W
R638	1-216-025-00	METAL CHIP 100 5%	1/10W
R639	1-216-073-00	METAL CHIP 10K 5%	1/10W
R640	1-216-061-00	METAL CHIP 3.3K 5%	1/10W
R641	1-216-097-00	METAL CHIP 100K 5%	1/10W
R642	1-216-105-00	METAL CHIP 220K 5%	1/10W
R643	1-216-073-00	METAL CHIP 10K 5%	1/10W
R644	1-216-053-00	METAL CHIP 1.5K 5%	1/10W
R645	1-216-073-00	METAL CHIP 10K 5%	1/10W
R646	1-216-049-00	METAL CHIP 1K 5%	1/10W
R647	1-216-049-00	METAL CHIP 1K 5%	1/10W
R650	1-216-025-00	METAL CHIP 100 5%	1/10W
R651	1-216-025-00	METAL CHIP 100 5%	1/10W
R652	1-216-025-00	METAL CHIP 100 5%	1/10W
R653	1-216-025-00	METAL CHIP 100 5%	1/10W
< VIBRATOR >			
X601	1-577-359-21	VIBRATOR, CERAMIC (4.19MHz)	

Ref. No.	Part No.	Description	Remark
*	1-645-589-11	LS-706 BOARD *****	
	3-947-260-01	HOLDER, SENSOR < CONNECTOR >	
CN101	1-506-468-11	PIN, CONNECTOR 3P < DIODE >	
D101	8-719-941-81	DIODE GL360 < TRANSISTOR >	
Q101	8-729-904-10	TRANSISTOR PT-360FS *****	
*	A-6421-838-A	MA-702 (E62) BOARD, COMPLETE *****	
		< CAPACITOR >	
C302	1-163-035-00	CERAMIC CHIP 0.047uF 50V	
C303	1-126-177-11	ELECT 100uF 20% 10V	
C304	1-124-465-00	ELECT 0.47uF 20% 50V	
C305	1-163-009-11	CERAMIC CHIP 0.001uF 10% 50V	
C306	1-163-145-00	CERAMIC CHIP 0.0015uF 5% 50V	
C307	1-126-795-11	ELECT 10uF 20% 50V	
C308	1-126-301-11	ELECT 1uF 20% 50V	
C309	1-126-301-11	ELECT 1uF 20% 50V	
C310	1-163-009-11	CERAMIC CHIP 0.001uF 10% 50V	
C311	1-126-795-11	ELECT 10uF 20% 50V	
C312	1-163-145-00	CERAMIC CHIP 0.0015uF 5% 50V	
C313	1-124-465-00	ELECT 0.47uF 20% 50V	
C314	1-126-177-11	ELECT 100uF 20% 10V	
C315	1-163-141-00	CERAMIC CHIP 0.001uF 5% 50V	
C316	1-163-141-00	CERAMIC CHIP 0.001uF 5% 50V	
		< CONNECTOR >	
CN301	1-506-473-11	PIN, CONNECTOR 8P	
CN302	1-506-468-11	PIN, CONNECTOR 3P < DIODE >	
D301	8-719-800-76	DIODE 1SS226	
D302	8-719-800-76	DIODE 1SS226	
D303	8-719-157-33	DIODE RD6. 2M-B	
D304	8-719-157-33	DIODE RD6. 2M-B < IC >	
IC301	8-759-636-55	IC M5218AFP	

Ref. No.	Part No.	Description	Remark
		< JACK >	
J301	1-507-678-00	JACK (MIC CONTROL)	
J302	1-507-805-21	JACK, LARGE TYPE (MIC 1)	
J303	1-507-805-21	JACK, LARGE TYPE (MIC 2) < RESISTOR >	
R301	1-216-025-00	METAL CHIP 100 5% 1/10W	
R302	1-216-055-00	METAL CHIP 1.8K 5% 1/10W	
R303	1-216-097-00	METAL CHIP 100K 5% 1/10W	
R304	1-216-073-00	METAL CHIP 10K 5% 1/10W	
R305	1-216-077-00	METAL CHIP 15K 5% 1/10W	
R306	1-216-025-00	METAL CHIP 100 5% 1/10W	
R307	1-216-025-00	METAL CHIP 100 5% 1/10W	
R308	1-216-097-00	METAL CHIP 100K 5% 1/10W	
R309	1-216-073-00	METAL CHIP 10K 5% 1/10W	
R310	1-216-077-00	METAL CHIP 15K 5% 1/10W	
R311	1-216-055-00	METAL CHIP 1.8K 5% 1/10W	
R312	1-249-409-11	CARBON 220 5% 1/4W F	
R313	1-249-409-11	CARBON 220 5% 1/4W F	
R314	1-216-025-00	METAL CHIP 100 5% 1/10W	
R315	1-216-025-00	METAL CHIP 100 5% 1/10W *****	
*	A-6421-835-A	MB-701 (E62) BOARD, COMPLETE *****	
*	3-947-805-01	PLATE, GROUND, JACK < CAPACITOR >	
C001	1-163-038-00	CERAMIC CHIP 0.1uF 25V	
C002	1-164-346-11	CERAMIC CHIP 1uF 16V	
C003	1-163-031-11	CERAMIC CHIP 0.01uF 50V	
C004	1-163-113-00	CERAMIC CHIP 68PF 5% 50V	
C005	1-126-154-11	ELECT 47uF 20% 6.3V	
C006	1-163-122-00	CERAMIC CHIP 160PF 5% 50V	
C008	1-163-031-11	CERAMIC CHIP 0.01uF 50V	
C009	1-163-038-00	CERAMIC CHIP 0.1uF 25V	
C010	1-163-038-00	CERAMIC CHIP 0.1uF 25V	
C011	1-124-584-00	ELECT 100uF 20% 10V	
C012	1-124-584-00	ELECT 100uF 20% 10V	
C013	1-124-584-00	ELECT 100uF 20% 10V	
C014	1-163-107-00	CERAMIC CHIP 39PF 5% 50V	
C015	1-163-038-00	CERAMIC CHIP 0.1uF 25V	
C016	1-163-031-11	CERAMIC CHIP 0.01uF 50V	
C018	1-124-584-00	ELECT 100uF 20% 10V	
C019	1-126-154-11	ELECT 47uF 20% 6.3V	
C020	1-163-038-00	CERAMIC CHIP 0.1uF 25V	
C021	1-124-261-00	ELECT 10uF 20% 50V	
C022	1-124-261-00	ELECT 10uF 20% 50V	

MB-701

Ref. No.	Part No.	Description	Remark		
C023	1-163-809-11	CERAMIC CHIP 0.047uF	10%		25V
C024	1-163-031-11	CERAMIC CHIP 0.01uF			50V
C025	1-163-031-11	CERAMIC CHIP 0.01uF			50V
C026	1-163-031-11	CERAMIC CHIP 0.01uF			50V
C027	1-163-031-11	CERAMIC CHIP 0.01uF			50V
C028	1-163-031-11	CERAMIC CHIP 0.01uF			50V
C029	1-163-031-11	CERAMIC CHIP 0.01uF			50V
C030	1-163-031-11	CERAMIC CHIP 0.01uF			50V
C032	1-163-031-11	CERAMIC CHIP 0.01uF			50V
C033	1-163-031-11	CERAMIC CHIP 0.01uF			50V
C035	1-163-031-11	CERAMIC CHIP 0.01uF			50V
C036	1-163-031-11	CERAMIC CHIP 0.01uF			50V
C037	1-163-038-00	CERAMIC CHIP 0.1uF			25V
C038	1-163-031-11	CERAMIC CHIP 0.01uF			50V
C039	1-163-031-11	CERAMIC CHIP 0.01uF			50V
C040	1-163-038-00	CERAMIC CHIP 0.1uF			25V
C041	1-163-031-11	CERAMIC CHIP 0.01uF			50V
C042	1-124-584-00	ELECT 100uF	20%		10V
C043	1-126-160-11	ELECT 1uF	20%		50V
C044	1-163-031-11	CERAMIC CHIP 0.01uF			50V
C045	1-126-160-11	ELECT 1uF	20%		50V
C046	1-124-584-00	ELECT 100uF	20%		10V
C047	1-216-295-00	METAL CHIP 0 5%	1/10W		
C048	1-163-096-00	CERAMIC CHIP 13PF	5%		50V
C049	1-124-584-00	ELECT 100uF	20%		10V
C050	1-163-093-00	CERAMIC CHIP 10PF	5%		50V
C051	1-163-099-00	CERAMIC CHIP 18PF	5%		50V
C052	1-163-097-00	CERAMIC CHIP 15PF	5%		50V
C053	1-163-031-11	CERAMIC CHIP 0.01uF			50V
C054	1-163-103-00	CERAMIC CHIP 27PF	5%		50V
C055	1-163-109-00	CERAMIC CHIP 47PF	5%		50V
C056	1-163-234-11	CERAMIC CHIP 20PF	5%		50V
C057	1-126-154-11	ELECT 47uF	20%		6.3V
C058	1-163-038-00	CERAMIC CHIP 0.1uF			25V
C059	1-124-261-00	ELECT 10uF	20%		50V
C060	1-163-038-00	CERAMIC CHIP 0.1uF			25V
C061	1-124-584-00	ELECT 100uF	20%		10V
C062	1-163-038-00	CERAMIC CHIP 0.1uF			25V
C064	1-124-584-00	ELECT 100uF	20%		10V
C065	1-163-038-00	CERAMIC CHIP 0.1uF			25V
C066	1-163-038-00	CERAMIC CHIP 0.1uF			25V
C068	1-163-099-00	CERAMIC CHIP 18PF	5%		50V
C069	1-124-584-00	ELECT 100uF	20%		10V
C071	1-163-038-00	CERAMIC CHIP 0.1uF			25V
C072	1-163-038-00	CERAMIC CHIP 0.1uF			25V
C073	1-124-584-00	ELECT 100uF	20%		10V
C074	1-124-584-00	ELECT 100uF	20%		10V
C075	1-163-038-00	CERAMIC CHIP 0.1uF			25V
C076	1-163-038-00	CERAMIC CHIP 0.1uF			25V

Ref. No.	Part No.	Description	Remark		
C077	1-163-038-00	CERAMIC CHIP 0.1uF			25V
C078	1-163-038-00	CERAMIC CHIP 0.1uF			25V
C079	1-163-038-00	CERAMIC CHIP 0.1uF			25V
C080	1-124-584-00	ELECT 100uF	20%		10V
C081	1-124-584-00	ELECT 100uF	20%		10V
C082	1-163-038-00	CERAMIC CHIP 0.1uF			25V
C083	1-163-038-00	CERAMIC CHIP 0.1uF			25V
C084	1-124-584-00	ELECT 100uF	20%		10V
C085	1-163-103-00	CERAMIC CHIP 27PF	5%		50V
C086	1-163-103-00	CERAMIC CHIP 27PF	5%		50V
C087	1-163-099-00	CERAMIC CHIP 18PF	5%		50V
C088	1-164-346-11	CERAMIC CHIP 1uF			16V
C089	1-163-112-00	CERAMIC CHIP 62PF	5%		50V
C090	1-163-031-11	CERAMIC CHIP 0.01uF			50V
C091	1-163-031-11	CERAMIC CHIP 0.01uF			50V
C092	1-124-584-00	ELECT 100uF	20%		10V
C093	1-163-038-00	CERAMIC CHIP 0.1uF			25V
C095	1-163-031-11	CERAMIC CHIP 0.01uF			50V
C096	1-163-031-11	CERAMIC CHIP 0.01uF			50V
C097	1-163-031-11	CERAMIC CHIP 0.01uF			50V
C098	1-216-295-00	METAL CHIP 0	5%		1/10W
C099	1-126-154-11	ELECT 47uF	20%		6.3V
C100	1-163-235-11	CERAMIC CHIP 22PF	5%		50V
C101	1-163-038-00	CERAMIC CHIP 0.1uF			25V
C102	1-126-154-11	ELECT 47uF	20%		6.3V
C103	1-164-505-11	CERAMIC CHIP 2.2uF			16V
C105	1-126-154-11	ELECT 47uF	20%		6.3V
C106	1-126-154-11	ELECT 47uF	20%		6.3V
C107	1-126-154-11	ELECT 47uF	20%		6.3V
C108	1-163-227-11	CERAMIC CHIP 10PF	5%		50V
C109	1-163-031-11	CERAMIC CHIP 0.01uF			50V
C111	1-163-031-11	CERAMIC CHIP 0.01uF			50V
C112	1-163-038-00	CERAMIC CHIP 0.1uF			25V
C113	1-163-038-00	CERAMIC CHIP 0.1uF			25V
C114	1-163-031-11	CERAMIC CHIP 0.01uF			50V
C115	1-164-005-11	CERAMIC CHIP 0.47uF			25V
C116	1-163-038-00	CERAMIC CHIP 0.1uF			25V
C117	1-163-038-00	CERAMIC CHIP 0.1uF			25V
C118	1-124-584-00	ELECT 100uF	20%		10V
C121	1-163-038-00	CERAMIC CHIP 0.1uF			25V
C122	1-163-038-00	CERAMIC CHIP 0.1uF			25V
C133	1-163-038-00	CERAMIC CHIP 0.1uF			25V
C134	1-163-038-00	CERAMIC CHIP 0.1uF			25V
C135	1-163-038-00	CERAMIC CHIP 0.1uF			25V
C136	1-163-101-00	CERAMIC CHIP 22PF	5%		50V
C137	1-163-103-00	CERAMIC CHIP 27PF	5%		50V
C138	1-163-095-00	CERAMIC CHIP 12PF	5%		50V
C139	1-163-038-00	CERAMIC CHIP 0.1uF			25V
C140	1-163-038-00	CERAMIC CHIP 0.1uF			25V

Ref. No.	Part No.	Description	Remark
C141	1-163-038-00	CERAMIC CHIP 0.1uF	25V
C151	1-163-038-00	CERAMIC CHIP 0.1uF	25V
C152	1-124-257-00	ELECT 2.2uF	20% 50V
C153	1-124-261-00	ELECT 10uF	20% 50V
C155	1-163-097-00	CERAMIC CHIP 15PF	5% 50V
C156	1-163-097-00	CERAMIC CHIP 15PF	5% 50V
C157	1-164-005-11	CERAMIC CHIP 0.47uF	25V
C158	1-164-232-11	CERAMIC CHIP 0.01uF	50V
C159	1-163-115-00	CERAMIC CHIP 82PF	5% 50V
C160	1-163-038-00	CERAMIC CHIP 0.1uF	25V
C161	1-164-232-11	CERAMIC CHIP 0.01uF	50V
C162	1-163-111-00	CERAMIC CHIP 56PF	5% 50V
C163	1-163-101-00	CERAMIC CHIP 22PF	5% 50V
C165	1-163-101-00	CERAMIC CHIP 22PF	5% 50V
C166	1-163-088-00	CERAMIC CHIP 5PF	50V
C167	1-163-106-00	CERAMIC CHIP 36PF	5% 50V
C168	1-163-121-00	CERAMIC CHIP 150PF	5% 50V
C201	1-126-320-11	ELECT, NONPOLAR R 10uF	20% 16V
C202	1-124-499-11	ELECT, NONPOLAR R 1uF	20% 50V
C203	1-163-031-11	CERAMIC CHIP 0.01uF	50V
C204	1-126-154-11	ELECT 47uF	20% 6.3V
C205	1-126-163-11	ELECT 4.7uF	20% 50V
C206	1-163-031-11	CERAMIC CHIP 0.01uF	50V
C207	1-126-154-11	ELECT 47uF	20% 6.3V
C208	1-163-031-11	CERAMIC CHIP 0.01uF	50V
C209	1-164-232-11	CERAMIC CHIP 0.01uF	50V
C210	1-126-154-11	ELECT 47uF	20% 6.3V
C211	1-163-113-00	CERAMIC CHIP 68PF	5% 50V
C212	1-163-113-00	CERAMIC CHIP 68PF	5% 50V
C213	1-126-163-11	ELECT 4.7uF	20% 50V
C214	1-163-038-00	CERAMIC CHIP 0.1uF	25V
C215	1-124-584-00	ELECT 100uF	20% 10V
C216	1-163-031-11	CERAMIC CHIP 0.01uF	50V
C217	1-163-031-11	CERAMIC CHIP 0.01uF	50V
C218	1-124-589-11	ELECT 47uF	20% 16V
C219	1-124-589-11	ELECT 47uF	20% 16V
C220	1-124-589-11	ELECT 47uF	20% 16V
C221	1-163-038-00	CERAMIC CHIP 0.1uF	25V
C222	1-126-163-11	ELECT 4.7uF	20% 50V
C223	1-126-154-11	ELECT 47uF	20% 6.3V
C225	1-126-163-11	ELECT 4.7uF	20% 50V
C226	1-163-107-00	CERAMIC CHIP 39PF	5% 50V
C227	1-126-163-11	ELECT 4.7uF	20% 50V
C228	1-163-017-00	CERAMIC CHIP 0.0047uF	5% 50V
C229	1-126-163-11	ELECT 4.7uF	20% 50V
C230	1-163-143-00	CERAMIC CHIP 0.0012uF	5% 50V
C231	1-124-589-11	ELECT 47uF	20% 16V
C232	1-163-115-00	CERAMIC CHIP 82PF	5% 50V

Ref. No.	Part No.	Description	Remark
C235	1-126-163-11	ELECT 4.7uF	20% 50V
C236	1-163-107-00	CERAMIC CHIP 39PF	5% 50V
C237	1-124-589-11	ELECT 47uF	20% 16V
C238	1-163-038-00	CERAMIC CHIP 0.1uF	25V
C240	1-163-038-00	CERAMIC CHIP 0.1uF	25V
C241	1-163-038-00	CERAMIC CHIP 0.1uF	25V
C243	1-163-107-00	CERAMIC CHIP 39PF	5% 50V
C245	1-124-589-11	ELECT 47uF	20% 16V
C246	1-124-589-11	ELECT 47uF	20% 16V
C247	1-163-019-00	CERAMIC CHIP 0.0068uF	10% 50V
C249	1-163-011-11	CERAMIC CHIP 0.0015uF	10% 50V
C250	1-126-154-11	ELECT 47uF	20% 6.3V
C251	1-163-038-00	CERAMIC CHIP 0.1uF	25V
C252	1-163-809-11	CERAMIC CHIP 0.047uF	10% 25V
C253	1-163-031-11	CERAMIC CHIP 0.01uF	50V
C255	1-163-115-00	CERAMIC CHIP 82PF	5% 50V
C256	1-163-017-00	CERAMIC CHIP 0.0047uF	5% 50V
C257	1-163-143-00	CERAMIC CHIP 0.0012uF	5% 50V
C258	1-163-038-00	CERAMIC CHIP 0.1uF	25V
C259	1-163-107-00	CERAMIC CHIP 39PF	5% 50V
C261	1-163-031-11	CERAMIC CHIP 0.01uF	50V
C262	1-124-584-00	ELECT 100uF	20% 10V
C263	1-124-589-11	ELECT 47uF	20% 16V
C264	1-163-038-00	CERAMIC CHIP 0.1uF	25V
C265	1-163-809-11	CERAMIC CHIP 0.047uF	10% 25V
C266	1-124-261-00	ELECT 10uF	20% 50V
C268	1-163-033-00	CERAMIC CHIP 0.022uF	50V
C269	1-124-443-00	ELECT 100uF	20% 10V
C270	1-124-584-00	ELECT 100uF	20% 10V
C271	1-163-031-11	CERAMIC CHIP 0.01uF	50V
C272	1-163-011-11	CERAMIC CHIP 0.0015uF	10% 50V
C273	1-124-584-00	ELECT 100uF	20% 10V
C274	1-124-261-00	ELECT 10uF	20% 50V
C275	1-124-584-00	ELECT 100uF	20% 10V
C276	1-163-009-11	CERAMIC CHIP 0.001uF	10% 50V
C277	1-163-003-11	CERAMIC CHIP 330PF	10% 50V
C278	1-124-248-00	ELECT 22uF	20% 35V
C279	1-163-017-00	CERAMIC CHIP 0.0047uF	5% 50V
C280	1-124-584-00	ELECT 100uF	20% 10V
C281	1-136-165-00	FILM 0.1uF	5% 50V
C282	1-136-160-00	FILM 0.039uF	5% 50V
C284	1-163-111-00	CERAMIC CHIP 56PF	5% 50V
C285	1-124-288-00	ELECT 22uF	20% 6.3V
C286	1-163-031-11	CERAMIC CHIP 0.01uF	50V
C287	1-163-241-11	CERAMIC CHIP 39PF	5% 50V
C288	1-164-232-11	CERAMIC CHIP 0.01uF	50V
C289	1-163-111-00	CERAMIC CHIP 56PF	5% 50V
C290	1-124-288-00	ELECT 22uF	20% 6.3V
C291	1-163-031-11	CERAMIC CHIP 0.01uF	50V

MB-701

Ref. No.	Part No.	Description	Remark
C293	1-136-160-00	FILM 0.039uF 5%	50V
C294	1-163-253-11	CERAMIC CHIP 120PF 5%	50V
C295	1-163-017-00	CERAMIC CHIP 0.0047uF 5%	50V
C296	1-124-465-00	ELECT 0.47uF 20%	50V
C297	1-163-009-11	CERAMIC CHIP 0.001uF 10%	50V
C298	1-163-031-11	CERAMIC CHIP 0.01uF	50V
C299	1-124-584-00	ELECT 100uF 20%	10V
C300	1-163-127-00	CERAMIC CHIP 270PF 5%	50V
C301	1-164-232-11	CERAMIC CHIP 0.01uF	50V
C302	1-124-248-00	ELECT 22uF 20%	35V
C303	1-163-017-00	CERAMIC CHIP 0.0047uF 5%	50V
C304	1-124-584-00	ELECT 100uF 20%	10V
C305	1-163-011-11	CERAMIC CHIP 0.0015uF 10%	50V
C306	1-124-584-00	ELECT 100uF 20%	10V
C309	1-163-017-00	CERAMIC CHIP 0.0047uF 5%	50V
C314	1-163-038-00	CERAMIC CHIP 0.1uF	25V
C315	1-124-584-00	ELECT 100uF 20%	10V
C316	1-163-102-00	CERAMIC CHIP 24PF 5%	50V
C317	1-126-163-11	ELECT 4.7uF 20%	50V
C318	1-163-038-00	CERAMIC CHIP 0.1uF	25V
C319	1-163-141-00	CERAMIC CHIP 0.001uF 5%	50V
C320	1-163-141-00	CERAMIC CHIP 0.001uF 5%	50V
C321	1-163-141-00	CERAMIC CHIP 0.001uF 5%	50V
C322	1-163-141-00	CERAMIC CHIP 0.001uF 5%	50V
C401	1-126-163-11	ELECT 4.7uF 20%	50V
C402	1-164-699-11	CERAMIC CHIP 0.0033uF 5%	50V
C403	1-163-111-00	CERAMIC CHIP 56PF 5%	50V
C404	1-126-163-11	ELECT 4.7uF 20%	50V
C406	1-124-589-11	ELECT 47uF 20%	16V
C407	1-163-117-00	CERAMIC CHIP 100PF 5%	50V
C601	1-126-154-11	ELECT 47uF 20%	6.3V
C602	1-163-035-00	CERAMIC CHIP 0.047uF	50V
C607	1-163-035-00	CERAMIC CHIP 0.047uF	50V
C609	1-164-232-11	CERAMIC CHIP 0.01uF	50V
C610	1-163-035-00	CERAMIC CHIP 0.047uF	50V
C611	1-163-035-00	CERAMIC CHIP 0.047uF	50V
C612	1-102-074-00	CERAMIC 0.001uF 10%	50V
C613	1-164-232-11	CERAMIC CHIP 0.01uF	50V
C629	1-164-699-11	CERAMIC CHIP 0.0033uF 5%	50V
C640	1-124-248-00	ELECT 22uF 20%	35V
C641	1-163-035-00	CERAMIC CHIP 0.047uF	50V
C650	1-163-123-00	CERAMIC CHIP 180PF 5%	50V
C652	1-163-038-00	CERAMIC CHIP 0.1uF	25V
C657	1-163-141-00	CERAMIC CHIP 0.001uF 5%	50V
C699	1-163-117-00	CERAMIC CHIP 100PF 5%	50V
C701	1-163-038-00	CERAMIC CHIP 0.1uF	25V
C702	1-124-471-00	ELECT 1000uF 20%	6.3V
C703	1-163-038-00	CERAMIC CHIP 0.1uF	25V
C704	1-163-038-00	CERAMIC CHIP 0.1uF	25V

Ref. No.	Part No.	Description	Remark
C705	1-124-604-00	ELECT 330uF 20%	10V
C706	1-124-604-00	ELECT 330uF 20%	10V
C708	1-126-233-11	ELECT 22uF 20%	50V
< CONNECTOR >			
CN201	1-506-482-11	PIN, CONNECTOR 3P	
CN205	1-573-123-11	CONNECTOR, BOARD TO BOARD 15P	
* CN601	1-564-029-00	PIN, CONNECTOR 4P	
CN602	1-563-493-11	CONNECTOR, F. P. C 28P	
CN603	1-506-483-21	PIN, CONNECTOR 4P	
CN605	1-506-481-11	PIN, CONNECTOR 2P	
CN606	1-506-481-11	PIN, CONNECTOR 2P	
CN607	1-506-482-11	PIN, CONNECTOR 3P	
CN608	1-506-484-11	PIN, CONNECTOR 5P	
CN609	1-506-491-11	PIN, CONNECTOR 12P	
CN701	1-506-482-11	PIN, CONNECTOR 3P	
< TRIMMER >			
CT001	1-141-227-00	CAP, TRIMMER 20PF	
< DIODE >			
D001	8-719-400-18	DIODE MA152WK	
D002	8-719-400-18	DIODE MA152WK	
D003	8-719-800-76	DIODE 1SS226	
D004	8-719-400-18	DIODE MA152WK	
D201	8-719-907-19	DIODE FC52M-5	
D202	8-719-907-19	DIODE FC52M-5	
D203	8-719-400-18	DIODE MA152WK	
D204	8-719-104-34	DIODE 1S2836	
D205	8-719-400-18	DIODE MA152WK	
D207	8-719-106-43	DIODE RD9.1M-B1	
D208	8-719-400-18	DIODE MA152WK	
D212	8-719-400-18	DIODE MA152WK	
D213	8-719-400-18	DIODE MA152WK	
D214	8-719-400-18	DIODE MA152WK	
D215	8-719-400-18	DIODE MA152WK	
D216	8-719-400-18	DIODE MA152WK	
D401	8-719-400-18	DIODE MA152WK	
D602	8-719-400-18	DIODE MA152WK	
D699	8-719-106-71	DIODE RD12M-B2	
D701	8-719-106-71	DIODE RD12M-B2	
< FILTER >			
FL001	1-239-319-11	FILTER, LOW PASS	
FL002	1-236-843-11	FILTER, BAND PASS	
FL005	1-239-317-11	FILTER, LOW PASS	
FL006	1-236-071-11	ENCAPSULATED COMPONENT	

Ref. No.	Part No.	Description	Remark
FL007	1-577-543-21	FILTER, CERAMIC	
FL008	1-577-543-11	FILTER, CERAMIC	
FL009	1-577-543-11	FILTER, CERAMIC	
FL010	1-236-071-11	ENCAPSULATED COMPONENT	
FL011	1-236-071-11	ENCAPSULATED COMPONENT	
FL012	1-236-071-11	ENCAPSULATED COMPONENT	
FL013	1-236-071-11	ENCAPSULATED COMPONENT	
FL201	1-236-071-11	ENCAPSULATED COMPONENT	
FL202	1-236-071-11	ENCAPSULATED COMPONENT	
FL203	1-236-071-11	ENCAPSULATED COMPONENT	
FL204	1-236-071-11	ENCAPSULATED COMPONENT	
FL206	1-236-840-21	FILTER, BAND PASS	
FL601	1-236-071-11	ENCAPSULATED COMPONENT	
FL602	1-236-071-11	ENCAPSULATED COMPONENT	
< IC >			
IC001	8-759-063-25	IC CXA8020Q	
IC003	8-759-063-26	IC CXD8405Q	
IC004	8-759-074-02	IC M50455-350FP-TE1	
IC005	8-759-063-27	IC CXD8404Q	
IC007	8-759-243-19	IC TC7SU04F	
IC201	8-749-921-12	IC GP1F32T	
IC202	8-759-981-92	IC RC4558M	
IC203	8-759-008-67	IC MC14066BF	
IC204	8-752-342-65	IC CXD2560M	
IC205	8-759-981-92	IC RC4558M	
IC206	8-759-981-92	IC RC4558M	
IC207	8-759-981-92	IC RC4558M	
IC208	8-752-337-26	IC CXD2500AQ	
IC209	8-759-981-92	IC RC4558M	
IC210	8-759-981-92	IC RC4558M	
IC211	8-759-981-92	IC RC4558M	
IC212	8-759-502-42	IC PA0034A	
IC214	8-752-351-19	IC CXD2561BM	
IC401	8-759-983-74	IC LM324NS	
IC402	8-759-009-06	IC MC14052BF	
IC601	8-759-063-88	IC 1C MB89795-137	
IC603	8-759-231-92	IC TA7291P	
IC604	8-759-063-89	IC MSM72H051GS-V1K	
△IC701	8-759-245-79	IC TA79005S	
△IC702	8-759-701-58	IC NJM78M08FA	
△IC703	8-759-700-67	IC RC79L08A	
< JACK >			
J001	1-691-964-12	CONNECTOR (ROUND TYPE) (S VIDEO OUT)	
J201	1-565-351-41	JACK, PIN 3P (LINE OUT 2)	
J202	1-565-351-41	JACK, PIN 3P (LINE OUT 1)	
J203	1-507-678-00	JACK (CONTROL S IN)	

Ref. No.	Part No.	Description	Remark
< JUMPER RESISTOR >			
JR010	1-216-295-00	METAL CHIP	0 5% 1/10W
JR011	1-216-295-00	METAL CHIP	0 5% 1/10W
JR012	1-216-295-00	METAL CHIP	0 5% 1/10W
JR013	1-216-295-00	METAL CHIP	0 5% 1/10W
JR014	1-216-295-00	METAL CHIP	0 5% 1/10W
JR015	1-216-295-00	METAL CHIP	0 5% 1/10W
JR016	1-216-295-00	METAL CHIP	0 5% 1/10W
JR017	1-216-295-00	METAL CHIP	0 5% 1/10W
JR018	1-216-296-00	METAL CHIP	0 5% 1/8W
JR019	1-216-296-00	METAL CHIP	0 5% 1/8W
JR020	1-216-296-00	METAL CHIP	0 5% 1/8W
JR021	1-216-295-00	METAL CHIP	0 5% 1/10W
JR022	1-216-295-00	METAL CHIP	0 5% 1/10W
JR201	1-216-296-00	METAL CHIP	0 5% 1/8W
JR202	1-216-296-00	METAL CHIP	0 5% 1/8W
JR207	1-216-295-00	METAL CHIP	0 5% 1/10W
JR209	1-216-295-00	METAL CHIP	0 5% 1/10W
JR210	1-216-295-00	METAL CHIP	0 5% 1/10W
JR216	1-216-296-00	METAL CHIP	0 5% 1/8W
JR219	1-216-296-00	METAL CHIP	0 5% 1/8W
< COIL >			
L001	1-408-609-41	INDUCTOR 33uH	
L002	1-408-407-00	INDUCTOR 6.8uH	
L003	1-408-411-00	INDUCTOR 15uH	
L005	1-408-609-41	INDUCTOR 33uH	
L006	1-408-609-41	INDUCTOR 33uH	
L007	1-408-411-00	INDUCTOR 15uH	
L010	1-408-409-00	INDUCTOR 10uH	
L011	1-408-609-41	INDUCTOR 33uH	
L013	1-408-609-41	INDUCTOR 33uH	
L016	1-408-414-00	INDUCTOR 27uH	
L017	1-408-412-00	INDUCTOR 18uH	
L020	1-408-413-00	INDUCTOR 22uH	
L201	1-408-421-00	INDUCTOR 100uH	
L202	1-408-418-00	INDUCTOR 56uH	
L203	1-408-417-00	INDUCTOR 47uH	
L204	1-408-403-00	INDUCTOR 3.3uH	
L610	1-408-409-00	INDUCTOR 10uH	
< IC LINK >			
△PS701	1-532-840-21	LINK, IC PRF1250 (1.25A 60V)	
△PS702	1-532-840-21	LINK, IC PRF1250 (1.25A 60V)	
△PS703	1-532-836-21	LINK, IC PRF500 (500A 60V)	
< TRANSISTOR >			
Q001	8-729-216-22	TRANSISTOR 2SA1162-G	

The components identified by mark △ or dotted line with mark △ are critical for safety. Replace only with part number specified.

MB-701

Ref. No.	Part No.	Description	Remark
Q002	8-729-100-66	TRANSISTOR 2SC1623-L6	
Q003	8-729-216-22	TRANSISTOR 2SA1162-G	
Q004	8-729-100-66	TRANSISTOR 2SC1623-L6	
Q005	8-729-900-53	TRANSISTOR DTC114EK	
Q008	8-729-162-13	TRANSISTOR 2SC1621-BC	
Q010	8-729-216-22	TRANSISTOR 2SA1162-G	
Q012	8-729-100-66	TRANSISTOR 2SC1623-L6	
Q013	8-729-100-66	TRANSISTOR 2SC1623-L6	
Q014	8-729-216-22	TRANSISTOR 2SA1162-G	
Q015	8-729-216-22	TRANSISTOR 2SA1162-G	
Q016	8-729-216-22	TRANSISTOR 2SA1162-G	
Q017	8-729-100-66	TRANSISTOR 2SC1623-L6	
Q018	8-729-216-22	TRANSISTOR 2SA1162-G	
Q019	8-729-100-66	TRANSISTOR 2SC1623-L6	
Q020	8-729-900-53	TRANSISTOR DTC114EK	
Q023	8-729-216-22	TRANSISTOR 2SA1162-G	
Q024	8-729-216-22	TRANSISTOR 2SA1162-G	
Q025	8-729-216-22	TRANSISTOR 2SA1162-G	
Q026	8-729-216-22	TRANSISTOR 2SA1162-G	
Q027	8-729-100-66	TRANSISTOR 2SC1623-L6	
Q028	8-729-100-66	TRANSISTOR 2SC1623-L6	
Q029	8-729-100-66	TRANSISTOR 2SC1623-L6	
Q030	8-729-100-66	TRANSISTOR 2SC1623-L6	
Q031	8-729-100-66	TRANSISTOR 2SC1623-L6	
Q032	8-729-100-66	TRANSISTOR 2SC1623-L6	
Q033	8-729-100-66	TRANSISTOR 2SC1623-L6	
Q034	8-729-100-66	TRANSISTOR 2SC1623-L6	
Q035	8-729-100-66	TRANSISTOR 2SC1623-L6	
Q037	8-729-100-66	TRANSISTOR 2SC1623-L6	
Q039	8-729-100-66	TRANSISTOR 2SC1623-L6	
Q040	8-729-100-66	TRANSISTOR 2SC1623-L6	
Q041	8-729-901-06	TRANSISTOR DTA114EK	
Q201	8-729-100-66	TRANSISTOR 2SC1623-L6	
Q202	8-729-202-38	TRANSISTOR 2SC3326N-A	
Q203	8-729-202-38	TRANSISTOR 2SC3326N-A	
Q204	8-729-202-38	TRANSISTOR 2SC3326N-A	
Q205	8-729-901-04	TRANSISTOR DTA114EK	
Q206	8-729-202-38	TRANSISTOR 2SC3326N-A	
Q207	8-729-202-38	TRANSISTOR 2SC3326N-A	
Q208	8-729-202-38	TRANSISTOR 2SC3326N-A	
Q209	8-729-900-53	TRANSISTOR DTC114EK	
Q210	8-729-901-04	TRANSISTOR DTA114EK	
Q211	8-729-900-53	TRANSISTOR DTC114EK	
Q212	8-729-900-53	TRANSISTOR DTC114EK	
Q213	8-729-901-04	TRANSISTOR DTA114EK	
Q214	8-729-900-53	TRANSISTOR DTC114EK	
Q215	8-729-901-04	TRANSISTOR DTA114EK	
Q216	8-729-900-53	TRANSISTOR DTC114EK	
Q217	8-729-216-22	TRANSISTOR 2SA1162-G	

Ref. No.	Part No.	Description	Remark
Q218	8-729-100-66	TRANSISTOR 2SC1623-L6	
Q219	8-729-100-66	TRANSISTOR 2SC1623-L6	
Q220	8-729-216-22	TRANSISTOR 2SA1162-G	
Q222	8-729-901-04	TRANSISTOR DTA114EK	
Q223	8-729-202-38	TRANSISTOR 2SC3326N-A	
Q224	8-729-202-38	TRANSISTOR 2SC3326N-A	
Q225	8-729-202-38	TRANSISTOR 2SC3326N-A	
Q226	8-729-202-38	TRANSISTOR 2SC3326N-A	
Q229	8-729-901-04	TRANSISTOR DTA114EK	
Q230	8-729-900-53	TRANSISTOR DTC114EK	
Q601	8-729-216-22	TRANSISTOR 2SA1162-G	
Q609	8-729-100-66	TRANSISTOR 2SC1623-L6	
Q701	8-729-159-65	TRANSISTOR 2SD596-DV5	
< RESISTOR >			
R001	1-216-081-00	METAL CHIP 22K 5%	1/10W
R002	1-216-051-00	METAL CHIP 1.2K 5%	1/10W
R003	1-216-047-00	METAL CHIP 820 5%	1/10W
R004	1-216-043-00	METAL CHIP 560 5%	1/10W
R005	1-216-073-00	METAL CHIP 10K 5%	1/10W
R006	1-216-051-00	METAL CHIP 1.2K 5%	1/10W
R007	1-216-049-00	METAL CHIP 1K 5%	1/10W
R008	1-216-035-00	METAL CHIP 270 5%	1/10W
R009	1-216-063-00	METAL CHIP 3.9K 5%	1/10W
R010	1-216-061-00	METAL CHIP 3.3K 5%	1/10W
R011	1-216-064-00	METAL CHIP 4.3K 5%	1/10W
R012	1-216-045-00	METAL CHIP 680 5%	1/10W
R013	1-216-053-00	METAL CHIP 1.5K 5%	1/10W
R014	1-216-689-11	METAL CHIP 39K 0.5%	1/10W
R015	1-216-041-00	METAL CHIP 470 5%	1/10W
R016	1-216-085-00	METAL CHIP 33K 5%	1/10W
R017	1-216-081-00	METAL CHIP 22K 5%	1/10W
R018	1-216-079-00	METAL CHIP 18K 5%	1/10W
R019	1-216-081-00	METAL CHIP 22K 5%	1/10W
R023	1-216-057-00	METAL CHIP 2.2K 5%	1/10W
R024	1-216-073-00	METAL CHIP 10K 5%	1/10W
R025	1-216-073-00	METAL CHIP 10K 5%	1/10W
R026	1-216-073-00	METAL CHIP 10K 5%	1/10W
R027	1-216-081-00	METAL CHIP 22K 5%	1/10W
R028	1-216-061-00	METAL CHIP 3.3K 5%	1/10W
R029	1-216-085-00	METAL CHIP 33K 5%	1/10W
R030	1-216-057-00	METAL CHIP 2.2K 5%	1/10W
R031	1-216-689-11	METAL CHIP 39K 0.5%	1/10W
R032	1-216-037-00	METAL CHIP 330 5%	1/10W
R033	1-216-079-00	METAL CHIP 18K 5%	1/10W
R035	1-216-075-00	METAL CHIP 12K 5%	1/10W
R036	1-216-061-00	METAL CHIP 3.3K 5%	1/10W
R037	1-216-053-00	METAL CHIP 1.5K 5%	1/10W

Ref. No.	Part No.	Description	Remark		
R039	1-216-051-00	METAL CHIP	1.2K	5%	1/10W
R040	1-216-055-00	METAL CHIP	1.8K	5%	1/10W
R041	1-216-049-00	METAL CHIP	1K	5%	1/10W
R042	1-216-049-00	METAL CHIP	1K	5%	1/10W
R043	1-216-041-00	METAL CHIP	470	5%	1/10W
R045	1-216-057-00	METAL CHIP	2.2K	5%	1/10W
R048	1-216-045-00	METAL CHIP	680	5%	1/10W
R049	1-216-045-00	METAL CHIP	680	5%	1/10W
R050	1-216-049-00	METAL CHIP	1K	5%	1/10W
R051	1-216-061-00	METAL CHIP	3.3K	5%	1/10W
R052	1-216-059-00	METAL CHIP	2.7K	5%	1/10W
R053	1-216-055-00	METAL CHIP	1.8K	5%	1/10W
R054	1-216-059-00	METAL CHIP	2.7K	5%	1/10W
R055	1-216-049-00	METAL CHIP	1K	5%	1/10W
R056	1-216-073-00	METAL CHIP	10K	5%	1/10W
R057	1-216-025-00	METAL CHIP	100	5%	1/10W
R058	1-216-051-00	METAL CHIP	1.2K	5%	1/10W
R059	1-216-053-00	METAL CHIP	1.5K	5%	1/10W
R060	1-216-041-00	METAL CHIP	470	5%	1/10W
R061	1-216-049-00	METAL CHIP	1K	5%	1/10W
R062	1-216-049-00	METAL CHIP	1K	5%	1/10W
R063	1-216-031-00	METAL CHIP	180	5%	1/10W
R064	1-216-049-00	METAL CHIP	1K	5%	1/10W
R065	1-216-031-00	METAL CHIP	180	5%	1/10W
R066	1-216-072-00	METAL CHIP	9.1K	5%	1/10W
R067	1-216-049-00	METAL CHIP	1K	5%	1/10W
R068	1-216-065-00	METAL CHIP	4.7K	5%	1/10W
R075	1-216-041-00	METAL CHIP	470	5%	1/10W
R076	1-216-049-00	METAL CHIP	1K	5%	1/10W
R077	1-216-041-00	METAL CHIP	470	5%	1/10W
R078	1-216-041-00	METAL CHIP	470	5%	1/10W
R079	1-216-045-00	METAL CHIP	680	5%	1/10W
R080	1-216-047-00	METAL CHIP	820	5%	1/10W
R081	1-216-041-00	METAL CHIP	470	5%	1/10W
R082	1-216-085-00	METAL CHIP	33K	5%	1/10W
R083	1-216-041-00	METAL CHIP	470	5%	1/10W
R084	1-216-041-00	METAL CHIP	470	5%	1/10W
R085	1-216-041-00	METAL CHIP	470	5%	1/10W
R086	1-216-049-00	METAL CHIP	1K	5%	1/10W
R087	1-216-041-00	METAL CHIP	470	5%	1/10W
R088	1-216-049-00	METAL CHIP	1K	5%	1/10W
R089	1-216-049-00	METAL CHIP	1K	5%	1/10W
R092	1-216-047-00	METAL CHIP	820	5%	1/10W
R093	1-216-119-00	METAL CHIP	820K	5%	1/10W
R094	1-216-295-00	METAL CHIP	0	5%	1/10W
R096	1-216-049-00	METAL CHIP	1K	5%	1/10W
R097	1-216-049-00	METAL CHIP	1K	5%	1/10W
R098	1-216-057-00	METAL CHIP	2.2K	5%	1/10W

Ref. No.	Part No.	Description	Remark		
R099	1-216-061-00	METAL CHIP	3.3K	5%	1/10W
R100	1-216-029-00	METAL CHIP	150	5%	1/10W
R101	1-216-041-00	METAL CHIP	470	5%	1/10W
R102	1-216-041-00	METAL CHIP	470	5%	1/10W
R103	1-216-041-00	METAL CHIP	470	5%	1/10W
R104	1-216-041-00	METAL CHIP	470	5%	1/10W
R105	1-216-041-00	METAL CHIP	470	5%	1/10W
R106	1-216-041-00	METAL CHIP	470	5%	1/10W
R108	1-216-041-00	METAL CHIP	470	5%	1/10W
R109	1-216-041-00	METAL CHIP	470	5%	1/10W
R110	1-216-295-00	METAL CHIP	0	5%	1/10W
R111	1-216-037-00	METAL CHIP	330	5%	1/10W
R112	1-216-037-00	METAL CHIP	330	5%	1/10W
R113	1-216-065-00	METAL CHIP	4.7K	5%	1/10W
R114	1-216-065-00	METAL CHIP	4.7K	5%	1/10W
R115	1-216-121-00	METAL CHIP	1M	5%	1/10W
R116	1-216-065-00	METAL CHIP	4.7K	5%	1/10W
R117	1-216-049-00	METAL CHIP	1K	5%	1/10W
R118	1-216-091-00	METAL CHIP	56K	5%	1/10W
R119	1-216-037-00	METAL CHIP	330	5%	1/10W
R120	1-216-031-00	METAL CHIP	180	5%	1/10W
R121	1-216-081-00	METAL CHIP	22K	5%	1/10W
R122	1-216-081-00	METAL CHIP	22K	5%	1/10W
R123	1-216-031-00	METAL CHIP	180	5%	1/10W
R124	1-216-031-00	METAL CHIP	180	5%	1/10W
R125	1-216-081-00	METAL CHIP	22K	5%	1/10W
R126	1-216-049-00	METAL CHIP	1K	5%	1/10W
R127	1-216-059-00	METAL CHIP	2.7K	5%	1/10W
R128	1-216-037-00	METAL CHIP	330	5%	1/10W
R130	1-216-059-00	METAL CHIP	2.7K	5%	1/10W
R132	1-216-059-00	METAL CHIP	2.7K	5%	1/10W
R133	1-216-049-00	METAL CHIP	1K	5%	1/10W
R134	1-216-043-00	METAL CHIP	560	5%	1/10W
R135	1-216-053-00	METAL CHIP	1.5K	5%	1/10W
R136	1-216-041-00	METAL CHIP	470	5%	1/10W
R137	1-216-043-00	METAL CHIP	560	5%	1/10W
R138	1-216-062-00	METAL CHIP	3.6K	5%	1/10W
R139	1-216-041-00	METAL CHIP	470	5%	1/10W
R140	1-216-029-00	METAL CHIP	150	5%	1/10W
R141	1-216-041-00	METAL CHIP	470	5%	1/10W
R142	1-216-073-00	METAL CHIP	10K	5%	1/10W
R143	1-216-043-00	METAL CHIP	560	5%	1/10W
R144	1-216-049-00	METAL CHIP	1K	5%	1/10W
R145	1-216-025-00	METAL CHIP	100	5%	1/10W
R146	1-216-049-00	METAL CHIP	1K	5%	1/10W
R147	1-216-021-00	METAL CHIP	68	5%	1/10W
R148	1-216-021-00	METAL CHIP	68	5%	1/10W
R149	1-216-041-00	METAL CHIP	470	5%	1/10W
R150	1-216-049-00	METAL CHIP	1K	5%	1/10W

MB-701

Ref. No.	Part No.	Description	Remark			Ref. No.	Part No.	Description	Remark		
R151	1-216-041-00	METAL CHIP	470	5%	1/10W	R217	1-216-097-00	METAL CHIP	100K	5%	1/10W
R152	1-216-041-00	METAL CHIP	470	5%	1/10W	R218	1-216-049-00	METAL CHIP	1K	5%	1/10W
R153	1-216-041-00	METAL CHIP	470	5%	1/10W	R219	1-216-033-00	METAL CHIP	220	5%	1/10W
R154	1-216-041-00	METAL CHIP	470	5%	1/10W	R220	1-216-033-00	METAL CHIP	220	5%	1/10W
R155	1-216-021-00	METAL CHIP	68	5%	1/10W	R221	1-216-105-00	METAL CHIP	220K	5%	1/10W
R156	1-216-021-00	METAL CHIP	68	5%	1/10W	R222	1-216-073-00	METAL CHIP	10K	5%	1/10W
R157	1-216-041-00	METAL CHIP	470	5%	1/10W	R223	1-216-105-00	METAL CHIP	220K	5%	1/10W
R158	1-216-021-00	METAL CHIP	68	5%	1/10W	R224	1-216-073-00	METAL CHIP	10K	5%	1/10W
R159	1-216-041-00	METAL CHIP	470	5%	1/10W	R225	1-216-097-00	METAL CHIP	100K	5%	1/10W
R161	1-216-021-00	METAL CHIP	68	5%	1/10W	R226	1-216-121-00	METAL CHIP	1M	5%	1/10W
R162	1-216-021-00	METAL CHIP	68	5%	1/10W	R227	1-216-041-00	METAL CHIP	470	5%	1/10W
R163	1-216-049-00	METAL CHIP	1K	5%	1/10W	R228	1-216-041-00	METAL CHIP	470	5%	1/10W
R164	1-216-021-00	METAL CHIP	68	5%	1/10W	R229	1-216-049-00	METAL CHIP	1K	5%	1/10W
R165	1-216-041-00	METAL CHIP	470	5%	1/10W	R230	1-216-061-00	METAL CHIP	3.3K	5%	1/10W
R166	1-216-041-00	METAL CHIP	470	5%	1/10W	R232	1-216-105-00	METAL CHIP	220K	5%	1/10W
R167	1-216-021-00	METAL CHIP	68	5%	1/10W	R233	1-216-049-00	METAL CHIP	1K	5%	1/10W
R168	1-216-021-00	METAL CHIP	68	5%	1/10W	R234	1-216-041-00	METAL CHIP	470	5%	1/10W
R169	1-216-041-00	METAL CHIP	470	5%	1/10W	R235	1-216-033-00	METAL CHIP	220	5%	1/10W
R170	1-216-041-00	METAL CHIP	470	5%	1/10W	R236	1-216-033-00	METAL CHIP	220	5%	1/10W
R171	1-216-021-00	METAL CHIP	68	5%	1/10W	R237	1-216-689-11	METAL CHIP	39K	0.5%	1/10W
R183	1-216-083-00	METAL CHIP	27K	5%	1/10W	R238	1-216-077-00	METAL CHIP	15K	5%	1/10W
R184	1-216-071-00	METAL CHIP	8.2K	5%	1/10W	R239	1-216-693-11	METAL CHIP	56K	0.5%	1/10W
R185	1-216-113-00	METAL CHIP	470K	5%	1/10W	R240	1-216-057-00	METAL CHIP	2.2K	5%	1/10W
R186	1-216-059-00	METAL CHIP	2.7K	5%	1/10W	R241	1-216-105-00	METAL CHIP	220K	5%	1/10W
R187	1-216-057-00	METAL CHIP	2.2K	5%	1/10W	R242	1-216-105-00	METAL CHIP	220K	5%	1/10W
R188	1-216-073-00	METAL CHIP	10K	5%	1/10W	R243	1-216-105-00	METAL CHIP	220K	5%	1/10W
R189	1-216-073-00	METAL CHIP	10K	5%	1/10W	R244	1-216-049-00	METAL CHIP	1K	5%	1/10W
R190	1-216-073-00	METAL CHIP	10K	5%	1/10W	R245	1-216-655-11	METAL CHIP	1.5K	0.5%	1/10W
R191	1-216-049-00	METAL CHIP	1K	5%	1/10W	R246	1-216-655-11	METAL CHIP	1.5K	0.5%	1/10W
R194	1-216-295-00	METAL CHIP	0	5%	1/10W	R247	1-216-073-00	METAL CHIP	10K	5%	1/10W
R195	1-216-041-00	METAL CHIP	470	5%	1/10W	R248	1-216-061-00	METAL CHIP	3.3K	5%	1/10W
R196	1-216-071-00	METAL CHIP	8.2K	5%	1/10W	R251	1-216-105-00	METAL CHIP	220K	5%	1/10W
R197	1-216-049-00	METAL CHIP	1K	5%	1/10W	R252	1-216-073-00	METAL CHIP	10K	5%	1/10W
R198	1-216-057-00	METAL CHIP	2.2K	5%	1/10W	R253	1-216-049-00	METAL CHIP	1K	5%	1/10W
R201	1-216-057-00	METAL CHIP	2.2K	5%	1/10W	R254	1-216-105-00	METAL CHIP	220K	5%	1/10W
R202	1-216-693-11	METAL CHIP	56K	0.5%	1/10W	R255	1-216-105-00	METAL CHIP	220K	5%	1/10W
R203	1-216-693-11	METAL CHIP	56K	0.5%	1/10W	R256	1-216-033-00	METAL CHIP	220	5%	1/10W
R204	1-216-693-11	METAL CHIP	56K	0.5%	1/10W	R257	1-216-033-00	METAL CHIP	220	5%	1/10W
R205	1-216-073-00	METAL CHIP	10K	5%	1/10W	R258	1-216-689-11	METAL CHIP	39K	0.5%	1/10W
R206	1-216-065-00	METAL CHIP	4.7K	5%	1/10W	R259	1-216-077-00	METAL CHIP	15K	5%	1/10W
R207	1-216-073-00	METAL CHIP	10K	5%	1/10W	R260	1-216-693-11	METAL CHIP	56K	0.5%	1/10W
R208	1-216-049-00	METAL CHIP	1K	5%	1/10W	R261	1-216-105-00	METAL CHIP	220K	5%	1/10W
R209	1-216-033-00	METAL CHIP	220	5%	1/10W	R262	1-216-057-00	METAL CHIP	2.2K	5%	1/10W
R210	1-216-033-00	METAL CHIP	220	5%	1/10W	R263	1-216-105-00	METAL CHIP	220K	5%	1/10W
R211	1-216-037-00	METAL CHIP	330	5%	1/10W	R264	1-216-105-00	METAL CHIP	220K	5%	1/10W
R212	1-216-693-11	METAL CHIP	56K	0.5%	1/10W	R265	1-216-073-00	METAL CHIP	10K	5%	1/10W
R214	1-216-105-00	METAL CHIP	220K	5%	1/10W	R266	1-216-105-00	METAL CHIP	220K	5%	1/10W
R215	1-216-073-00	METAL CHIP	10K	5%	1/10W	R268	1-216-689-11	METAL CHIP	39K	0.5%	1/10W
R216	1-216-097-00	METAL CHIP	100K	5%	1/10W	R269	1-216-077-00	METAL CHIP	15K	5%	1/10W

Ref. No.	Part No.	Description	Remark		
R270	1-216-061-00	METAL CHIP	3.3K	5%	1/10W
R271	1-216-693-11	METAL CHIP	56K	0.5%	1/10W
R272	1-216-095-00	METAL CHIP	82K	5%	1/10W
R273	1-216-061-00	METAL CHIP	3.3K	5%	1/10W
R276	1-216-049-00	METAL CHIP	1K	5%	1/10W
R279	1-216-073-00	METAL CHIP	10K	5%	1/10W
R280	1-216-655-11	METAL CHIP	1.5K	0.5%	1/10W
R281	1-216-655-11	METAL CHIP	1.5K	0.5%	1/10W
R282	1-216-049-00	METAL CHIP	1K	5%	1/10W
R283	1-216-689-11	METAL CHIP	39K	0.5%	1/10W
R284	1-216-077-00	METAL CHIP	15K	5%	1/10W
R285	1-216-049-00	METAL CHIP	1K	5%	1/10W
R286	1-216-693-11	METAL CHIP	56K	0.5%	1/10W
R287	1-216-099-00	METAL CHIP	120K	5%	1/10W
R288	1-216-099-00	METAL CHIP	120K	5%	1/10W
R289	1-216-095-00	METAL CHIP	82K	5%	1/10W
R290	1-216-081-00	METAL CHIP	22K	5%	1/10W
R291	1-216-081-00	METAL CHIP	22K	5%	1/10W
R292	1-216-049-00	METAL CHIP	1K	5%	1/10W
R293	1-216-109-00	METAL CHIP	330K	5%	1/10W
R294	1-216-049-00	METAL CHIP	1K	5%	1/10W
R295	1-216-109-00	METAL CHIP	330K	5%	1/10W
R296	1-216-049-00	METAL CHIP	1K	5%	1/10W
R297	1-216-065-00	METAL CHIP	4.7K	5%	1/10W
R298	1-216-073-00	METAL CHIP	10K	5%	1/10W
R299	1-216-118-00	METAL GLAZE	750K	5%	1/10W
R300	1-216-071-00	METAL CHIP	8.2K	5%	1/10W
R301	1-216-097-00	METAL CHIP	100K	5%	1/10W
R302	1-216-101-00	METAL CHIP	150K	5%	1/10W
R303	1-216-065-00	METAL CHIP	4.7K	5%	1/10W
R305	1-216-069-00	METAL CHIP	6.8K	5%	1/10W
R306	1-216-057-00	METAL CHIP	2.2K	5%	1/10W
R307	1-216-101-00	METAL CHIP	150K	5%	1/10W
R308	1-216-104-00	METAL CHIP	200K	5%	1/10W
R309	1-216-033-00	METAL CHIP	220	5%	1/10W
R310	1-216-049-00	METAL CHIP	1K	5%	1/10W
R311	1-216-078-00	METAL GLAZE	16K	5%	1/10W
R312	1-216-057-00	METAL CHIP	2.2K	5%	1/10W
R313	1-216-053-00	METAL CHIP	1.5K	5%	1/10W
R314	1-216-017-00	METAL CHIP	47	5%	1/10W
R315	1-216-049-00	METAL CHIP	1K	5%	1/10W
R316	1-216-049-00	METAL CHIP	1K	5%	1/10W
R317	1-216-049-00	METAL CHIP	1K	5%	1/10W
R318	1-216-053-00	METAL CHIP	1.5K	5%	1/10W
R319	1-216-057-00	METAL CHIP	2.2K	5%	1/10W
R320	1-216-049-00	METAL CHIP	1K	5%	1/10W
R321	1-216-078-00	METAL GLAZE	16K	5%	1/10W
R322	1-216-057-00	METAL CHIP	2.2K	5%	1/10W

Ref. No.	Part No.	Description	Remark		
R323	1-216-033-00	METAL CHIP	220	5%	1/10W
R324	1-216-051-00	METAL CHIP	1.2K	5%	1/10W
R325	1-216-041-00	METAL CHIP	470	5%	1/10W
R326	1-216-023-00	METAL CHIP	82	5%	1/10W
R327	1-216-118-00	METAL GLAZE	750K	5%	1/10W
R328	1-216-071-00	METAL CHIP	8.2K	5%	1/10W
R329	1-216-065-00	METAL CHIP	4.7K	5%	1/10W
R330	1-216-073-00	METAL CHIP	10K	5%	1/10W
R331	1-216-065-00	METAL CHIP	4.7K	5%	1/10W
R332	1-216-045-00	METAL CHIP	680	5%	1/10W
R334	1-216-295-00	METAL CHIP	0	5%	1/10W
R337	1-216-045-00	METAL CHIP	680	5%	1/10W
R343	1-216-049-00	METAL CHIP	1K	5%	1/10W
R344	1-216-073-00	METAL CHIP	10K	5%	1/10W
R345	1-216-689-11	METAL CHIP	39K	0.5%	1/10W
R346	1-216-689-11	METAL CHIP	39K	0.5%	1/10W
R347	1-216-067-00	METAL CHIP	5.6K	5%	1/10W
R348	1-216-067-00	METAL CHIP	5.6K	5%	1/10W
R349	1-216-689-11	METAL CHIP	39K	0.5%	1/10W
R350	1-216-689-11	METAL CHIP	39K	0.5%	1/10W
R351	1-216-067-00	METAL CHIP	5.6K	5%	1/10W
R352	1-216-067-00	METAL CHIP	5.6K	5%	1/10W
R353	1-216-295-00	METAL CHIP	0	5%	1/10W
R354	1-216-295-00	METAL CHIP	0	5%	1/10W
R355	1-216-039-00	METAL CHIP	390	5%	1/10W
R356	1-216-049-00	METAL CHIP	1K	5%	1/10W
R357	1-216-049-00	METAL CHIP	1K	5%	1/10W
R358	1-216-073-00	METAL CHIP	10K	5%	1/10W
R359	1-216-049-00	METAL CHIP	1K	5%	1/10W
R360	1-216-049-00	METAL CHIP	1K	5%	1/10W
R361	1-216-049-00	METAL CHIP	1K	5%	1/10W
R362	1-216-049-00	METAL CHIP	1K	5%	1/10W
R363	1-216-025-00	METAL CHIP	100	5%	1/10W
R364	1-216-073-00	METAL CHIP	10K	5%	1/10W
R365	1-216-073-00	METAL CHIP	10K	5%	1/10W
R366	1-216-097-00	METAL CHIP	100K	5%	1/10W
R367	1-216-049-00	METAL CHIP	1K	5%	1/10W
R368	1-216-049-00	METAL CHIP	1K	5%	1/10W
R369	1-216-049-00	METAL CHIP	1K	5%	1/10W
R372	1-216-689-11	METAL CHIP	39K	0.5%	1/10W
R373	1-216-073-00	METAL CHIP	10K	5%	1/10W
R374	1-216-049-00	METAL CHIP	1K	5%	1/10W
R375	1-216-049-00	METAL CHIP	1K	5%	1/10W
R376	1-216-049-00	METAL CHIP	1K	5%	1/10W
R383	1-216-073-00	METAL CHIP	10K	5%	1/10W
R401	1-216-687-11	METAL CHIP	33K	0.5%	1/10W
R402	1-216-687-11	METAL CHIP	33K	0.5%	1/10W
R403	1-216-699-11	METAL CHIP	100K	0.5%	1/10W
R404	1-216-077-00	METAL CHIP	15K	5%	1/10W

MB-701

Ref. No.	Part No.	Description	Remark
R405	1-216-685-11	METAL CHIP	27K 0.5% 1/10W
R406	1-218-165-11	METAL GLAZE	220K 1% 1/10W
R407	1-216-675-11	METAL CHIP	10K 0.5% 1/10W
R408	1-216-113-00	METAL CHIP	470K 5% 1/10W
R409	1-216-677-11	METAL CHIP	12K 0.5% 1/10W
R410	1-216-530-00	METAL GLAZE	390K 1% 1/10W
R411	1-216-679-11	METAL CHIP	15K 0.5% 1/10W
R412	1-216-035-00	METAL CHIP	270 5% 1/10W
R413	1-216-089-00	METAL CHIP	47K 5% 1/10W
R414	1-216-089-00	METAL CHIP	47K 5% 1/10W
R415	1-216-111-00	METAL CHIP	390K 5% 1/10W
R416	1-216-089-00	METAL CHIP	47K 5% 1/10W
R417	1-216-105-00	METAL CHIP	220K 5% 1/10W
R423	1-216-049-00	METAL CHIP	1K 5% 1/10W
R431	1-216-033-00	METAL CHIP	220 5% 1/10W
R432	1-216-049-00	METAL CHIP	1K 5% 1/10W
R434	1-216-033-00	METAL CHIP	220 5% 1/10W
R435	1-216-115-00	METAL CHIP	560K 5% 1/10W
R502	1-216-053-00	METAL CHIP	1.5K 5% 1/10W
R503	1-216-057-00	METAL CHIP	2.2K 5% 1/10W
R504	1-216-057-00	METAL CHIP	2.2K 5% 1/10W
R505	1-216-047-00	METAL CHIP	820 5% 1/10W
R506	1-216-085-00	METAL CHIP	33K 5% 1/10W
R507	1-216-085-00	METAL CHIP	33K 5% 1/10W
R508	1-216-101-00	METAL CHIP	150K 5% 1/10W
R509	1-216-047-00	METAL CHIP	820 5% 1/10W
R511	1-216-057-00	METAL CHIP	2.2K 5% 1/10W
R513	1-216-049-00	METAL CHIP	1K 5% 1/10W
R514	1-216-097-00	METAL CHIP	100K 5% 1/10W
R515	1-216-121-00	METAL CHIP	1M 5% 1/10W
R516	1-216-072-00	METAL CHIP	9.1K 5% 1/10W
R517	1-216-198-00	METAL CHIP	1K 5% 1/8W
R518	1-216-061-00	METAL CHIP	3.3K 5% 1/10W
R519	1-216-049-00	METAL CHIP	1K 5% 1/10W
R520	1-216-049-00	METAL CHIP	1K 5% 1/10W
R521	1-216-049-00	METAL CHIP	1K 5% 1/10W
R522	1-216-049-00	METAL CHIP	1K 5% 1/10W
R580	1-216-049-00	METAL CHIP	1K 5% 1/10W
R588	1-216-073-00	METAL CHIP	10K 5% 1/10W
R593	1-216-073-00	METAL CHIP	10K 5% 1/10W
R594	1-216-037-00	METAL CHIP	330 5% 1/10W
R595	1-216-053-00	METAL CHIP	1.5K 5% 1/10W
R596	1-216-057-00	METAL CHIP	2.2K 5% 1/10W
R599	1-216-073-00	METAL CHIP	10K 5% 1/10W
R601	1-216-121-00	METAL CHIP	1M 5% 1/10W
R602	1-216-081-00	METAL CHIP	22K 5% 1/10W
R603	1-216-073-00	METAL CHIP	10K 5% 1/10W
R604	1-216-021-00	METAL CHIP	68 5% 1/10W
R605	1-216-057-00	METAL CHIP	2.2K 5% 1/10W

Ref. No.	Part No.	Description	Remark
R606	1-216-081-00	METAL CHIP	22K 5% 1/10W
R607	1-216-065-00	METAL CHIP	4.7K 5% 1/10W
R608	1-216-057-00	METAL CHIP	2.2K 5% 1/10W
R609	1-216-057-00	METAL CHIP	2.2K 5% 1/10W
R610	1-216-057-00	METAL CHIP	2.2K 5% 1/10W
△R611	1-212-950-00	FUSIBLE	4.7 5% 1/2W F
R621	1-216-049-00	METAL CHIP	1K 5% 1/10W
R623	1-216-073-00	METAL CHIP	10K 5% 1/10W
R624	1-216-073-00	METAL CHIP	10K 5% 1/10W
R626	1-216-099-00	METAL CHIP	120K 5% 1/10W
R627	1-216-075-00	METAL CHIP	12K 5% 1/10W
R633	1-216-061-00	METAL CHIP	3.3K 5% 1/10W
R634	1-216-051-00	METAL CHIP	1.2K 5% 1/10W
R635	1-216-035-00	METAL CHIP	270 5% 1/10W
R636	1-216-049-00	METAL CHIP	1K 5% 1/10W
R637	1-216-081-00	METAL CHIP	22K 5% 1/10W
R638	1-216-081-00	METAL CHIP	22K 5% 1/10W
R640	1-216-025-00	METAL CHIP	100 5% 1/10W
R650	1-216-049-00	METAL CHIP	1K 5% 1/10W
R651	1-216-033-00	METAL CHIP	220 5% 1/10W
R652	1-216-033-00	METAL CHIP	220 5% 1/10W
R653	1-216-049-00	METAL CHIP	1K 5% 1/10W
R654	1-216-033-00	METAL CHIP	220 5% 1/10W
R655	1-216-049-00	METAL CHIP	1K 5% 1/10W
R656	1-216-033-00	METAL CHIP	220 5% 1/10W
R658	1-216-033-00	METAL CHIP	220 5% 1/10W
R659	1-216-049-00	METAL CHIP	1K 5% 1/10W
R660	1-216-033-00	METAL CHIP	220 5% 1/10W
R661	1-216-033-00	METAL CHIP	220 5% 1/10W
R662	1-216-033-00	METAL CHIP	220 5% 1/10W
R663	1-216-049-00	METAL CHIP	1K 5% 1/10W
R664	1-216-033-00	METAL CHIP	220 5% 1/10W
R667	1-216-033-00	METAL CHIP	220 5% 1/10W
R668	1-216-033-00	METAL CHIP	220 5% 1/10W
R669	1-216-049-00	METAL CHIP	1K 5% 1/10W
R670	1-216-049-00	METAL CHIP	1K 5% 1/10W
R671	1-216-049-00	METAL CHIP	1K 5% 1/10W
R672	1-216-033-00	METAL CHIP	220 5% 1/10W
R673	1-216-049-00	METAL CHIP	1K 5% 1/10W
R674	1-216-049-00	METAL CHIP	1K 5% 1/10W
R675	1-216-033-00	METAL CHIP	220 5% 1/10W
R676	1-216-033-00	METAL CHIP	220 5% 1/10W
R680	1-216-085-00	METAL CHIP	33K 5% 1/10W
R684	1-216-073-00	METAL CHIP	10K 5% 1/10W
R685	1-216-073-00	METAL CHIP	10K 5% 1/10W
R689	1-216-049-00	METAL CHIP	1K 5% 1/10W
R690	1-216-049-00	METAL CHIP	1K 5% 1/10W
R691	1-216-049-00	METAL CHIP	1K 5% 1/10W
R693	1-216-049-00	METAL CHIP	1K 5% 1/10W

The components identified by mark △ or dotted line with mark △ are critical for safety. Replace only with part number specified.

Ref. No.	Part No.	Description	Remark		
R694	1-216-049-00	METAL CHIP	1K	5%	1/10W
R695	1-216-049-00	METAL CHIP	1K	5%	1/10W
R698	1-216-049-00	METAL CHIP	1K	5%	1/10W
R699	1-216-049-00	METAL CHIP	1K	5%	1/10W
R700	1-216-013-00	METAL CHIP	33	5%	1/10W
R701	1-215-905-11	METAL OXIDE	10	5%	3W F
R702	1-216-073-00	METAL CHIP	10K	5%	1/10W
R703	1-216-041-00	METAL CHIP	470	5%	1/10W
< VARIABLE RESISTOR >					
RV002	1-230-871-11	RES, ADJ, METAL 22K			
< SWITCH >					
S201	1-553-725-21	SWITCH, SLIDE (ATT ON↔OFF)			
< VIBRATOR >					
X001	1-579-617-11	VIBRATOR, CRYSTAL (28.1958MHz)			
X201	1-579-618-11	VIBRATOR, CRYSTAL (22.5792MHz)			

MT-52 BOARD					

< CAPACITOR >					
C001	1-161-063-00	CERAMIC CHIP	0.01uF	10%	50V
< CONNECTOR >					
CN001	1-506-481-11	PIN, CONNECTOR 2P, MALE			

*	A-6421-841-A	PS-710 (E62) BOARD, COMPLETE			

< CAPACITOR >					
C101	1-126-946-11	ELECT	6800uF	20%	25V
C102	1-126-946-11	ELECT	6800uF	20%	25V
C103	1-163-038-00	CERAMIC CHIP	0.1uF		25V
C104	1-164-161-11	CERAMIC CHIP	0.0022uF	10%	100V
C105	1-163-989-11	CERAMIC CHIP	0.033uF	10%	25V
C106	1-126-101-11	ELECT	100uF	20%	16V
C107	1-126-917-11	ELECT	3300uF	20%	6.3V
C108	1-124-903-11	ELECT	1uF	20%	50V
C109	1-126-917-11	ELECT	3300uF	20%	6.3V
C110	1-163-833-00	CERAMIC CHIP	0.068uF		25V
C111	1-163-007-11	CERAMIC CHIP	680PF	10%	50V
C112	1-163-019-00	CERAMIC CHIP	0.0068uF	10%	50V
C114	1-124-478-11	ELECT	100uF	20%	25V
C115	1-163-037-11	CERAMIC CHIP	0.022uF	10%	25V
C116	1-163-833-00	CERAMIC CHIP	0.068uF		25V

Ref. No.	Part No.	Description	Remark		
C122	1-124-557-11	ELECT	1000uF	20%	25V
C125	1-124-920-11	ELECT	330uF	20%	63V
C126	1-124-910-11	ELECT	47uF	20%	50V
C127	1-124-122-11	ELECT	100uF	20%	50V
C128	1-124-120-11	ELECT	220uF	20%	25V
C131	1-124-479-11	ELECT	330uF	20%	25V
C132	1-124-122-11	ELECT	100uF	20%	50V
C133	1-124-477-11	ELECT	47uF	20%	25V
C134	1-163-038-00	CERAMIC CHIP	0.1uF		25V
C201	1-163-009-11	CERAMIC CHIP	0.001uF	10%	50V
C202	1-163-019-00	CERAMIC CHIP	0.0068uF	10%	50V
C204	1-163-009-11	CERAMIC CHIP	0.001uF	10%	50V
C205	1-163-017-00	CERAMIC CHIP	0.0047uF	5%	50V
C206	1-163-007-11	CERAMIC CHIP	680PF	10%	50V
C208	1-163-035-00	CERAMIC CHIP	0.047uF		50V
C209	1-163-017-00	CERAMIC CHIP	0.0047uF	5%	50V
C210	1-163-007-11	CERAMIC CHIP	680PF	10%	50V
C211	1-163-017-00	CERAMIC CHIP	0.0047uF	5%	50V
C212	1-163-035-00	CERAMIC CHIP	0.047uF		50V
C213	1-124-913-11	ELECT	470uF	20%	50V
< CONNECTOR >					
* CN101	1-560-894-00	PIN, CONNECTOR 6P			
CN105	1-506-473-11	PIN, CONNECTOR 8P			
* CN106	1-560-890-00	PIN, CONNECTOR 2P			
< DIODE >					
△D101	8-719-500-55	DIODE D3SBA10			
△D102	8-719-200-82	DIODE 11ES2			
△D103	8-719-200-82	DIODE 11ES2			
D105	8-719-980-78	DIODE ERA81-006			
D108	8-719-105-82	DIODE RD5.1M-B2			
△D109	8-719-200-82	DIODE 11ES2			
D110	8-719-110-83	DIODE RD36ES-B2			
D111	8-719-110-88	DIODE RD39ES-B2			
D112	8-719-110-06	DIODE RD8.2ES-B1			
△D113	8-719-200-82	DIODE 11ES2			
△D114	8-719-200-82	DIODE 11ES2			
D115	8-719-911-19	DIODE 1SS119			
△D116	8-719-200-82	DIODE 11ES2			
△D117	8-719-200-82	DIODE 11ES2			
D118	8-719-911-19	DIODE 1SS119			
D119	8-719-110-22	DIODE RD11ES-B2			
D120	8-719-911-19	DIODE 1SS119			
D201	8-719-980-78	DIODE ERA81-006			
D202	8-719-980-78	DIODE ERA81-006			
D203	8-719-200-82	DIODE 11ES2			
D204	8-719-200-82	DIODE 11ES2			
D205	8-719-911-19	DIODE 1SS119			

The components identified by mark △ or dotted line with mark. △ are critical for safety. Replace only with part number specified.

PS-710

Ref. No.	Part No.	Description	Remark
D206	8-719-911-19	DIODE 1SS119	
D207	8-719-911-19	DIODE 1SS119	
< FUSE >			
△F101	1-532-299-00	FUSE, TIME-LAG (5A 250V)	
△F102	1-532-299-00	FUSE, TIME-LAG (5A 250V)	
< IC >			
△IC101	8-759-971-39	IC BA9700AF	
△IC102	8-759-231-53	IC TA7805S	
IC201	8-759-085-67	IC LM339NS	
IC202	8-759-100-96	IC uPC4558G2	
< JUMPER RESISTOR >			
JR101	1-216-296-00	METAL CHIP	0 5% 1/8W
JR102	1-216-296-00	METAL CHIP	0 5% 1/8W
JR103	1-216-295-00	METAL CHIP	0 5% 1/10W
JR104	1-216-296-00	METAL CHIP	0 5% 1/8W
JR105	1-216-296-00	METAL CHIP	0 5% 1/8W
JR106	1-216-296-00	METAL CHIP	0 5% 1/8W
JR107	1-216-296-00	METAL CHIP	0 5% 1/8W
JR108	1-216-296-00	METAL CHIP	0 5% 1/8W
JR109	1-216-296-00	METAL CHIP	0 5% 1/8W
JR110	1-216-296-00	METAL CHIP	0 5% 1/8W
JR111	1-216-296-00	METAL CHIP	0 5% 1/8W
JR112	1-216-296-00	METAL CHIP	0 5% 1/8W
JR113	1-216-296-00	METAL CHIP	0 5% 1/8W
JR114	1-216-296-00	METAL CHIP	0 5% 1/8W
JR115	1-216-296-00	METAL CHIP	0 5% 1/8W
< COIL >			
L101	1-424-219-11	COIL, CHOKE 300uH	
L102	1-412-012-11	INDUCTOR 100uH	
L104	1-410-339-11	COIL, CHOKE 10uH	
L201	1-424-219-11	COIL, CHOKE 300uH	
< IC LINK >			
△PS103	1-532-829-11	LINK, IC PRF100 (60V 100mA)	
△PS105	1-532-841-21	LINK, IC PRF1600 (60V 1.6A)	
△PS201	1-532-675-00	LINK, IC ICP-N38 (1.5A)	
< TRANSISTOR >			
Q101	8-729-119-78	TRANSISTOR	2SC2785-HFE
Q102	8-729-216-22	TRANSISTOR	2SA1162-G
△Q103	8-729-117-11	TRANSISTOR	2SB1151-L
Q108	8-729-140-97	TRANSISTOR	2SB734-34
Q111	8-729-141-75	TRANSISTOR	2SD596DV345
Q112	8-729-142-46	TRANSISTOR	2SC2001-LK
△Q201	8-729-117-11	TRANSISTOR	2SB1151-L

Ref. No.	Part No.	Description	Remark
△Q202	8-729-143-30	TRANSISTOR	2SD1691K
△Q203	8-729-117-11	TRANSISTOR	2SB1151-L
△Q204	8-729-143-30	TRANSISTOR	2SD1691K
Q205	8-729-119-78	TRANSISTOR	2SC2785-HFE
Q206	8-729-216-22	TRANSISTOR	2SA1162-G
Q208	8-729-900-53	TRANSISTOR	DTC114EK
Q209	8-729-901-04	TRANSISTOR	DTA114EK
Q210	8-729-100-67	TRANSISTOR	2SC1623-L7
Q211	8-729-119-76	TRANSISTOR	2SA1175-HFE
Q212	8-729-901-04	TRANSISTOR	DTA114EK
< RESISTOR >			
R101	1-216-073-00	METAL CHIP	10K 5% 1/10W
R102	1-216-073-00	METAL CHIP	10K 5% 1/10W
R103	1-216-089-00	METAL CHIP	47K 5% 1/10W
R104	1-216-065-00	METAL CHIP	4.7K 5% 1/10W
R105	1-216-073-00	METAL CHIP	10K 5% 1/10W
R106	1-216-053-00	METAL CHIP	1.5K 5% 1/10W
R107	1-216-067-00	METAL CHIP	5.6K 5% 1/10W
R108	1-216-043-00	METAL CHIP	560 5% 1/10W
R109	1-216-691-11	METAL CHIP	47K 0.5% 1/10W
R110	1-216-679-11	METAL CHIP	15K 0.5% 1/10W
R112	1-216-099-00	METAL CHIP	120K 5% 1/10W
R114	1-216-097-00	METAL CHIP	100K 5% 1/10W
R120	1-216-043-00	METAL CHIP	560 5% 1/10W
R122	1-216-073-00	METAL CHIP	10K 5% 1/10W
R124	1-216-025-00	METAL CHIP	100 5% 1/10W
R125	1-216-057-00	METAL CHIP	2.2K 5% 1/10W
R126	1-212-867-00	FUSIBLE	27 5% 1/4W F
R128	1-216-053-00	METAL CHIP	1.5K 5% 1/10W
R129	1-216-073-00	METAL CHIP	10K 5% 1/10W
R199	1-216-079-00	METAL CHIP	18K 5% 1/10W
R201	1-216-081-00	METAL CHIP	22K 5% 1/10W
R202	1-216-075-00	METAL CHIP	12K 5% 1/10W
R203	1-216-093-00	METAL CHIP	68K 5% 1/10W
R204	1-216-065-00	METAL CHIP	4.7K 5% 1/10W
R205	1-216-075-00	METAL CHIP	12K 5% 1/10W
R206	1-216-097-00	METAL CHIP	100K 5% 1/10W
R207	1-216-073-00	METAL CHIP	10K 5% 1/10W
R208	1-216-073-00	METAL CHIP	10K 5% 1/10W
R209	1-216-073-00	METAL CHIP	10K 5% 1/10W
R210	1-216-105-00	METAL CHIP	220K 5% 1/10W
R211	1-216-073-00	METAL CHIP	10K 5% 1/10W
R212	1-216-065-00	METAL CHIP	4.7K 5% 1/10W
R213	1-216-049-00	METAL CHIP	1K 5% 1/10W
R214	1-247-750-11	CARBON	680 5% 1/2W
R215	1-247-750-11	CARBON	680 5% 1/2W
R216	1-216-049-00	METAL CHIP	1K 5% 1/10W
△R217	1-216-369-00	METAL OXIDE	1 5% 2W F

The components identified by mark △ or dotted line with mark △ are critical for safety. Replace only with part number specified.

Ref. No.	Part No.	Description	Remark		
R218	1-216-690-11	METAL CHIP	43K	0.5%	1/10W
R219	1-216-675-11	METAL CHIP	10K	0.5%	1/10W
R220	1-216-690-11	METAL CHIP	43K	0.5%	1/10W
R221	1-216-675-11	METAL CHIP	10K	0.5%	1/10W
R222	1-216-073-00	METAL CHIP	10K	5%	1/10W
R223	1-216-073-00	METAL CHIP	10K	5%	1/10W
△R224	1-215-866-11	METAL OXIDE	330	5%	1W F
R225	1-216-073-00	METAL CHIP	10K	5%	1/10W
R226	1-247-750-11	CARBON	680	5%	1/2W
R227	1-216-073-00	METAL CHIP	10K	5%	1/10W
R228	1-216-093-00	METAL CHIP	68K	5%	1/10W
R230	1-216-105-00	METAL CHIP	220K	5%	1/10W
< RELAY >					
△RY101	1-515-833-11	RELAY			

*	1-645-584-11	PW-701 BOARD			

< CAPACITOR >					
C701	1-126-157-11	ELECT	10uF	20%	16V
C702	1-163-031-11	CERAMIC CHIP	0.01uF		50V
< DIODE >					
D701	8-719-940-82	LED SLR34MC3			
D702	8-719-940-82	LED SLR34MC3			
D703	8-719-940-99	LED SLR34VC3			
< IC >					
IC701	8-741-100-48	IC SBX1610-59			
< COIL >					
L701	1-410-521-11	INDUCTOR 100uH			
< TRANSISTOR >					
Q701	8-729-901-04	TRANSISTOR DTA114EK			
< RESISTOR >					
R701	1-216-029-00	METAL CHIP	150	5%	1/10W
R702	1-216-059-00	METAL CHIP	2.7K	5%	1/10W
R703	1-216-029-00	METAL CHIP	150	5%	1/10W
R704	1-216-031-00	METAL CHIP	180	5%	1/10W
< SWITCH >					
S701	1-572-946-11	SWITCH, TACTIL (POWER)			

Ref. No.	Part No.	Description	Remark		
*	A-6421-465-A	SV-63 BOARD, COMPLETE			

< CAPACITOR >					
C001	1-163-038-00	CERAMIC CHIP	0.1uF		25V
C003	1-163-093-00	CERAMIC CHIP	10PF	5%	50V
C005	1-163-035-00	CERAMIC CHIP	0.047uF		50V
C006	1-163-035-00	CERAMIC CHIP	0.047uF		50V
C009	1-163-038-00	CERAMIC CHIP	0.1uF		25V
C010	1-163-121-00	CERAMIC CHIP	150PF	5%	50V
C011	1-163-017-00	CERAMIC CHIP	0.0047uF	5%	50V
C012	1-164-161-11	CERAMIC CHIP	0.0022uF	10%	100V
C013	1-124-584-00	ELECT	100uF	20%	10V
C014	1-164-232-11	CERAMIC CHIP	0.01uF		50V
C015	1-163-989-11	CERAMIC CHIP	0.033uF	10%	25V
C019	1-164-232-11	CERAMIC CHIP	0.01uF		50V
C020	1-124-465-00	ELECT	0.47uF	20%	50V
C021	1-164-232-11	CERAMIC CHIP	0.01uF		50V
C101	1-128-057-11	ELECT	330uF	20%	6.3V
C102	1-128-057-11	ELECT	330uF	20%	6.3V
C103	1-124-242-00	ELECT	33uF	20%	25V
C104	1-124-242-00	ELECT	33uF	20%	25V
C105	1-163-035-00	CERAMIC CHIP	0.047uF		50V
C106	1-163-035-00	CERAMIC CHIP	0.047uF		50V
C107	1-163-035-00	CERAMIC CHIP	0.047uF		50V
C108	1-163-035-00	CERAMIC CHIP	0.047uF		50V
C109	1-163-038-00	CERAMIC CHIP	0.1uF		25V
C110	1-163-038-00	CERAMIC CHIP	0.1uF		25V
C111	1-126-160-11	ELECT	1uF	20%	50V
C112	1-163-109-00	CERAMIC CHIP	47PF	5%	50V
C113	1-163-093-00	CERAMIC CHIP	10PF	5%	50V
C114	1-126-160-11	ELECT	1uF	20%	50V
C115	1-163-019-00	CERAMIC CHIP	0.0068uF	10%	50V
C116	1-126-160-11	ELECT	1uF	20%	50V
C117	1-164-161-11	CERAMIC CHIP	0.0022uF	10%	100V
C118	1-163-014-00	CERAMIC CHIP	0.0027uF	10%	50V
C119	1-163-038-00	CERAMIC CHIP	0.1uF		25V
C120	1-163-038-00	CERAMIC CHIP	0.1uF		25V
C121	1-163-037-11	CERAMIC CHIP	0.022uF	10%	25V
C122	1-163-129-00	CERAMIC CHIP	330PF	5%	50V
C123	1-163-115-00	CERAMIC CHIP	82PF	5%	50V
C124	1-163-101-00	CERAMIC CHIP	22PF	5%	50V
C125	1-163-137-00	CERAMIC CHIP	680PF	5%	50V
C126	1-163-093-00	CERAMIC CHIP	10PF	5%	50V
C127	1-124-499-11	ELECT, NONPOLAR R	1uF	20%	50V
C128	1-126-320-11	ELECT, NONPOLAR R	10uF	20%	16V
C129	1-136-165-00	FILM	0.1uF	5%	50V
C130	1-126-320-11	ELECT, NONPOLAR R	10uF	20%	16V
C131	1-163-037-11	CERAMIC CHIP	0.022uF	10%	25V

The components identified by mark △ or dotted line with mark △ are critical for safety. Replace only with part number specified.

Ref. No.	Part No.	Description	Remark
C132	1-163-035-00	CERAMIC CHIP 0.047uF	50V
C135	1-163-024-00	CERAMIC CHIP 0.018uF 10%	50V
C136	1-136-169-00	FILM 0.22uF 5%	50V
C137	1-163-022-00	CERAMIC CHIP 0.012uF 10%	50V
C138	1-163-022-00	CERAMIC CHIP 0.012uF 10%	50V
C139	1-124-282-00	ELECT 22uF 20%	16V
C140	1-104-485-11	ELECT 3.3uF 20%	25V
C141	1-164-232-11	CERAMIC CHIP 0.01uF	50V
C144	1-163-016-00	CERAMIC CHIP 0.0039uF 10%	50V
C145	1-163-024-00	CERAMIC CHIP 0.018uF 10%	50V
C146	1-164-232-11	CERAMIC CHIP 0.01uF	50V
C147	1-136-169-00	FILM 0.22uF 5%	50V
C149	1-164-232-11	CERAMIC CHIP 0.01uF	50V
C150	1-124-589-11	ELECT 47uF 20%	16V
C151	1-124-589-11	ELECT 47uF 20%	16V
C152	1-163-035-00	CERAMIC CHIP 0.047uF	50V
C153	1-163-035-00	CERAMIC CHIP 0.047uF	50V
< CONNECTOR >			
CN101	1-566-939-11	CONNECTOR, F. P. C 24P	
CN102	1-563-493-11	CONNECTOR, F. P. C 28P	
CN103	1-506-485-11	PIN, CONNECTOR 6P	
CN104	1-506-482-11	PIN, CONNECTOR 3P	
* CN105	1-566-969-11	HOUSING, CONNECTOR (PC BOARD) 7P	
* CN106	1-566-968-11	HOUSING, CONNECTOR (PC BOARD) 6P	
< DIODE >			
D001	8-719-911-19	DIODE 1SS119	
D101	8-719-911-19	DIODE 1SS119	
D102	8-719-109-72	DIODE RD3.9ES-B2	
D103	8-719-911-19	DIODE 1SS119	
D104	8-719-911-19	DIODE 1SS119	
< FUSE >			
F001	1-532-775-11	FUSE, MICRO (SECONDARY)	
< FILTER >			
FL001	1-235-922-11	FILTER, LOW PASS (1.7MHz)	
< IC >			
IC001	8-752-050-19	IC CXA1081M	
IC002	8-759-603-24	IC CX20197	
IC101	8-759-321-40	IC HA11529	
△IC102	8-759-822-38	IC LA6510	
IC103	8-759-981-92	IC RC4558M	
IC104	8-759-981-92	IC RC4558M	
IC105	8-759-981-92	IC RC4558M	
IC106	8-759-300-71	IC TC4053BF	

Ref. No.	Part No.	Description	Remark
< JUMPER RESISTOR >			
JR102	1-216-295-00	METAL CHIP 0 5%	1/10W
JR103	1-216-296-00	METAL CHIP 0 5%	1/8W
JR104	1-216-296-00	METAL CHIP 0 5%	1/8W
JR105	1-216-295-00	METAL CHIP 0 5%	1/10W
JR106	1-216-296-00	METAL CHIP 0 5%	1/8W
JR107	1-216-295-00	METAL CHIP 0 5%	1/10W
JR111	1-216-296-00	METAL CHIP 0 5%	1/8W
JR112	1-216-296-00	METAL CHIP 0 5%	1/8W
JR113	1-216-296-00	METAL CHIP 0 5%	1/8W
JR114	1-216-295-00	METAL CHIP 0 5%	1/10W
JR115	1-216-296-00	METAL CHIP 0 5%	1/8W
JR116	1-216-295-00	METAL CHIP 0 5%	1/10W
JR117	1-216-295-00	METAL CHIP 0 5%	1/10W
JR118	1-216-296-00	METAL CHIP 0 5%	1/8W
JR119	1-216-296-00	METAL CHIP 0 5%	1/8W
JR121	1-216-296-00	METAL CHIP 0 5%	1/8W
JR122	1-216-296-00	METAL CHIP 0 5%	1/8W
JR123	1-216-296-00	METAL CHIP 0 5%	1/8W
JR124	1-216-296-00	METAL CHIP 0 5%	1/8W
JR125	1-216-296-00	METAL CHIP 0 5%	1/8W
JR126	1-216-296-00	METAL CHIP 0 5%	1/8W
JR127	1-216-295-00	METAL CHIP 0 5%	1/10W
JR128	1-216-296-00	METAL CHIP 0 5%	1/8W
JR129	1-216-296-00	METAL CHIP 0 5%	1/8W
JR130	1-216-296-00	METAL CHIP 0 5%	1/8W
JR132	1-216-296-00	METAL CHIP 0 5%	1/8W
JR133	1-216-296-00	METAL CHIP 0 5%	1/8W
JR134	1-216-296-00	METAL CHIP 0 5%	1/8W
JR135	1-216-296-00	METAL CHIP 0 5%	1/8W
JR136	1-216-296-00	METAL CHIP 0 5%	1/8W
JR137	1-216-296-00	METAL CHIP 0 5%	1/8W
JR138	1-216-296-00	METAL CHIP 0 5%	1/8W
JR139	1-216-296-00	METAL CHIP 0 5%	1/8W
JR140	1-216-296-00	METAL CHIP 0 5%	1/8W
JR141	1-216-296-00	METAL CHIP 0 5%	1/8W
JR142	1-216-296-00	METAL CHIP 0 5%	1/8W
JR143	1-216-296-00	METAL CHIP 0 5%	1/8W
JR144	1-216-296-00	METAL CHIP 0 5%	1/8W
JR145	1-216-296-00	METAL CHIP 0 5%	1/8W
JR146	1-216-296-00	METAL CHIP 0 5%	1/8W
JR147	1-216-296-00	METAL CHIP 0 5%	1/8W
JR148	1-216-296-00	METAL CHIP 0 5%	1/8W
JR149	1-216-296-00	METAL CHIP 0 5%	1/8W
JR150	1-216-296-00	METAL CHIP 0 5%	1/8W
JR153	1-216-296-00	METAL CHIP 0 5%	1/8W
JR154	1-216-296-00	METAL CHIP 0 5%	1/8W
JR155	1-216-296-00	METAL CHIP 0 5%	1/8W

The components identified by mark △ or dotted line with mark △ are critical for safety. Replace only with part number specified.

Ref. No.	Part No.	Description	Remark		
JR156	1-216-296-00	METAL CHIP	0	5%	1/8W
JR158	1-216-295-00	METAL CHIP	0	5%	1/10W
JR159	1-216-296-00	METAL CHIP	0	5%	1/8W
JR160	1-216-296-00	METAL CHIP	0	5%	1/8W
JR161	1-216-296-00	METAL CHIP	0	5%	1/8W
JR162	1-216-296-00	METAL CHIP	0	5%	1/8W
JR164	1-216-296-00	METAL CHIP	0	5%	1/8W
JR166	1-216-295-00	METAL CHIP	0	5%	1/10W
JR170	1-216-296-00	METAL CHIP	0	5%	1/8W
JR171	1-216-295-00	METAL CHIP	0	5%	1/10W
JR172	1-216-296-00	METAL CHIP	0	5%	1/8W
JR173	1-216-296-00	METAL CHIP	0	5%	1/8W
JR174	1-216-296-00	METAL CHIP	0	5%	1/8W
JR175	1-216-295-00	METAL CHIP	0	5%	1/10W
JR176	1-216-296-00	METAL CHIP	0	5%	1/8W
JR177	1-216-296-00	METAL CHIP	0	5%	1/8W
JR178	1-216-296-00	METAL CHIP	0	5%	1/8W
JR179	1-216-296-00	METAL CHIP	0	5%	1/8W
JR180	1-216-296-00	METAL CHIP	0	5%	1/8W
JR181	1-216-296-00	METAL CHIP	0	5%	1/8W
JR182	1-216-296-00	METAL CHIP	0	5%	1/8W
JR183	1-216-295-00	METAL CHIP	0	5%	1/10W
JR184	1-216-296-00	METAL CHIP	0	5%	1/8W
JR185	1-216-296-00	METAL CHIP	0	5%	1/8W
JR186	1-216-296-00	METAL CHIP	0	5%	1/8W
JR187	1-216-296-00	METAL CHIP	0	5%	1/8W
JR188	1-216-296-00	METAL CHIP	0	5%	1/8W
JR189	1-216-295-00	METAL CHIP	0	5%	1/10W
JR191	1-216-296-00	METAL CHIP	0	5%	1/8W
JR192	1-216-296-00	METAL CHIP	0	5%	1/8W
JR193	1-216-296-00	METAL CHIP	0	5%	1/8W
JR194	1-216-296-00	METAL CHIP	0	5%	1/8W
JR195	1-216-295-00	METAL CHIP	0	5%	1/10W
JR196	1-216-296-00	METAL CHIP	0	5%	1/8W
JR197	1-216-296-00	METAL CHIP	0	5%	1/8W
JR198	1-216-296-00	METAL CHIP	0	5%	1/8W
JR199	1-216-296-00	METAL CHIP	0	5%	1/8W
JR200	1-216-296-00	METAL CHIP	0	5%	1/8W
JR201	1-216-296-00	METAL CHIP	0	5%	1/8W
JR202	1-216-296-00	METAL CHIP	0	5%	1/8W
JR203	1-216-296-00	METAL CHIP	0	5%	1/8W
JR204	1-216-296-00	METAL CHIP	0	5%	1/8W
JR205	1-216-295-00	METAL CHIP	0	5%	1/10W
JR206	1-216-295-00	METAL CHIP	0	5%	1/10W
JR207	1-216-296-00	METAL CHIP	0	5%	1/8W
JR208	1-216-296-00	METAL CHIP	0	5%	1/8W
JR209	1-216-295-00	METAL CHIP	0	5%	1/10W
JR210	1-216-295-00	METAL CHIP	0	5%	1/10W

Ref. No.	Part No.	Description	Remark		
JR211	1-216-296-00	METAL CHIP	0	5%	1/8W
JR212	1-216-296-00	METAL CHIP	0	5%	1/8W
JR213	1-216-296-00	METAL CHIP	0	5%	1/8W
JR214	1-216-296-00	METAL CHIP	0	5%	1/8W
JR215	1-216-295-00	METAL CHIP	0	5%	1/10W
JR216	1-216-295-00	METAL CHIP	0	5%	1/10W
JR217	1-216-295-00	METAL CHIP	0	5%	1/10W
JR218	1-216-296-00	METAL CHIP	0	5%	1/8W
JR219	1-216-295-00	METAL CHIP	0	5%	1/10W
JR220	1-216-296-00	METAL CHIP	0	5%	1/8W
JR221	1-216-296-00	METAL CHIP	0	5%	1/8W
< COIL >					
L101	1-410-509-11	INDUCTOR 10uH			
L102	1-410-509-11	INDUCTOR 10uH			
L103	1-410-509-11	INDUCTOR 10uH			
< TRANSISTOR >					
Q001	8-729-140-97	TRANSISTOR 2SB734-34			
Q002	8-729-216-22	TRANSISTOR 2SA1162-G			
Q003	8-729-303-37	TRANSISTOR 2SD655-E			
Q101	8-729-209-15	TRANSISTOR 2SD2012			
Q102	8-729-924-90	TRANSISTOR 2SB1370-EF			
Q103	8-729-209-15	TRANSISTOR 2SD2012			
Q104	8-729-924-90	TRANSISTOR 2SB1370-EF			
Q105	8-729-100-66	TRANSISTOR 2SC1623-L6			
Q106	8-729-100-66	TRANSISTOR 2SC1623-L6			
Q107	8-729-901-00	TRANSISTOR DTC124EK			
Q108	8-729-100-66	TRANSISTOR 2SC1623-L6			
Q109	8-729-216-22	TRANSISTOR 2SA1162-G			
< RESISTOR >					
R001	1-216-049-00	METAL CHIP	1K	5%	1/10W
R002	1-216-057-00	METAL CHIP	2.2K	5%	1/10W
R003	1-216-065-00	METAL CHIP	4.7K	5%	1/10W
R004	1-216-057-00	METAL CHIP	2.2K	5%	1/10W
R005	1-216-049-00	METAL CHIP	1K	5%	1/10W
R006	1-216-049-00	METAL CHIP	1K	5%	1/10W
R007	1-216-023-00	METAL CHIP	82	5%	1/10W
R008	1-216-043-00	METAL CHIP	560	5%	1/10W
R009	1-216-073-00	METAL CHIP	10K	5%	1/10W
R010	1-216-095-00	METAL CHIP	82K	5%	1/10W
R011	1-216-081-00	METAL CHIP	22K	5%	1/10W
R012	1-249-394-11	CARBON	12	5%	1/6W F
R013	1-216-073-00	METAL CHIP	10K	5%	1/10W
R014	1-216-097-00	METAL CHIP	100K	5%	1/10W
R015	1-216-049-00	METAL CHIP	1K	5%	1/10W
R016	1-216-101-00	METAL CHIP	150K	5%	1/10W

SV-63

Ref. No.	Part No.	Description	Remark		
R017	1-216-041-00	METAL CHIP	470	5%	1/10W
R018	1-216-065-00	METAL CHIP	4.7K	5%	1/10W
R020	1-216-049-00	METAL CHIP	1K	5%	1/10W
R021	1-216-065-00	METAL CHIP	4.7K	5%	1/10W
R022	1-216-081-00	METAL CHIP	22K	5%	1/10W
R023	1-249-394-11	CARBON	12	5%	1/6W F
R101	1-216-373-11	METAL OXIDE	2.2	5%	2W F
R103	1-216-073-00	METAL CHIP	10K	5%	1/10W
R104	1-216-073-00	METAL CHIP	10K	5%	1/10W
R105	1-216-073-00	METAL CHIP	10K	5%	1/10W
R106	1-216-061-00	METAL CHIP	3.3K	5%	1/10W
R107	1-216-089-00	METAL CHIP	47K	5%	1/10W
R108	1-216-061-00	METAL CHIP	3.3K	5%	1/10W
R109	1-216-061-00	METAL CHIP	3.3K	5%	1/10W
R110	1-216-061-00	METAL CHIP	3.3K	5%	1/10W
R111	1-216-073-00	METAL CHIP	10K	5%	1/10W
R112	1-216-101-00	METAL CHIP	150K	5%	1/10W
R113	1-216-077-00	METAL CHIP	15K	5%	1/10W
R114	1-216-025-00	METAL CHIP	100	5%	1/10W
R115	1-216-025-00	METAL CHIP	100	5%	1/10W
R116	1-216-061-00	METAL CHIP	3.3K	5%	1/10W
R117	1-216-073-00	METAL CHIP	10K	5%	1/10W
R118	1-216-073-00	METAL CHIP	10K	5%	1/10W
R119	1-216-073-00	METAL CHIP	10K	5%	1/10W
R120	1-216-073-00	METAL CHIP	10K	5%	1/10W
R121	1-216-057-00	METAL CHIP	2.2K	5%	1/10W
R122	1-216-085-00	METAL CHIP	33K	5%	1/10W
R123	1-216-061-00	METAL CHIP	3.3K	5%	1/10W
R124	1-216-079-00	METAL CHIP	18K	5%	1/10W
R125	1-216-081-00	METAL CHIP	22K	5%	1/10W
R126	1-216-033-00	METAL CHIP	220	5%	1/10W
R127	1-216-057-00	METAL CHIP	2.2K	5%	1/10W
R128	1-216-061-00	METAL CHIP	3.3K	5%	1/10W
R129	1-216-041-00	METAL CHIP	470	5%	1/10W
R130	1-216-017-00	METAL CHIP	47	5%	1/10W
R131	1-216-073-00	METAL CHIP	10K	5%	1/10W
R132	1-216-057-00	METAL CHIP	2.2K	5%	1/10W
R133	1-216-097-00	METAL CHIP	100K	5%	1/10W
R134	1-216-097-00	METAL CHIP	100K	5%	1/10W
R135	1-216-065-00	METAL CHIP	4.7K	5%	1/10W
R136	1-216-081-00	METAL CHIP	22K	5%	1/10W
R137	1-216-099-00	METAL CHIP	120K	5%	1/10W
R138	1-216-081-00	METAL CHIP	22K	5%	1/10W
R139	1-216-081-00	METAL CHIP	22K	5%	1/10W
R140	1-216-037-00	METAL CHIP	330	5%	1/10W
R141	1-216-024-00	METAL GLAZE	91	5%	1/10W
R142	1-216-001-00	METAL CHIP	10	5%	1/10W
R143	1-216-001-00	METAL CHIP	10	5%	1/10W
R144	1-216-055-00	METAL CHIP	1.8K	5%	1/10W

Ref. No.	Part No.	Description	Remark		
R145	1-216-055-00	METAL CHIP	1.8K	5%	1/10W
R146	1-216-073-00	METAL CHIP	10K	5%	1/10W
R147	1-216-081-00	METAL CHIP	22K	5%	1/10W
R148	1-216-037-00	METAL CHIP	330	5%	1/10W
R149	1-216-033-00	METAL CHIP	220	5%	1/10W
R150	1-216-085-00	METAL CHIP	33K	5%	1/10W
R151	1-216-113-00	METAL CHIP	470K	5%	1/10W
R152	1-216-057-00	METAL CHIP	2.2K	5%	1/10W
R153	1-216-085-00	METAL CHIP	33K	5%	1/10W
R154	1-216-101-00	METAL CHIP	150K	5%	1/10W
R155	1-216-089-00	METAL CHIP	47K	5%	1/10W
R156	1-216-083-00	METAL CHIP	27K	5%	1/10W
R157	1-216-101-00	METAL CHIP	150K	5%	1/10W
R158	1-216-057-00	METAL CHIP	2.2K	5%	1/10W
R159	1-216-075-00	METAL CHIP	12K	5%	1/10W
R160	1-216-083-00	METAL CHIP	27K	5%	1/10W
R161	1-216-113-00	METAL CHIP	470K	5%	1/10W
R162	1-216-051-00	METAL CHIP	1.2K	5%	1/10W
R163	1-216-083-00	METAL CHIP	27K	5%	1/10W
R164	1-216-035-00	METAL CHIP	270	5%	1/10W
R165	1-216-089-00	METAL CHIP	47K	5%	1/10W
R166	1-216-041-00	METAL CHIP	470	5%	1/10W
R167	1-216-049-00	METAL CHIP	1K	5%	1/10W
R168	1-216-049-00	METAL CHIP	1K	5%	1/10W
R169	1-216-049-00	METAL CHIP	1K	5%	1/10W
R170	1-216-049-00	METAL CHIP	1K	5%	1/10W
R171	1-216-049-00	METAL CHIP	1K	5%	1/10W
R172	1-216-049-00	METAL CHIP	1K	5%	1/10W
R173	1-216-085-00	METAL CHIP	33K	5%	1/10W
R174	1-216-073-00	METAL CHIP	10K	5%	1/10W
R175	1-216-085-00	METAL CHIP	33K	5%	1/10W
R176	1-216-689-11	METAL CHIP	39K	0.5%	1/10W
R177	1-216-085-00	METAL CHIP	33K	5%	1/10W
R178	1-216-073-00	METAL CHIP	10K	5%	1/10W
R179	1-216-101-00	METAL CHIP	150K	5%	1/10W
R180	1-216-689-11	METAL CHIP	39K	0.5%	1/10W
R181	1-216-083-00	METAL CHIP	27K	5%	1/10W
R182	1-216-067-00	METAL CHIP	5.6K	5%	1/10W
R183	1-216-067-00	METAL CHIP	5.6K	5%	1/10W
R184	1-216-089-00	METAL CHIP	47K	5%	1/10W
R186	1-216-097-00	METAL CHIP	100K	5%	1/10W
R187	1-216-089-00	METAL CHIP	47K	5%	1/10W
R188	1-216-065-00	METAL CHIP	4.7K	5%	1/10W
R189	1-216-061-00	METAL CHIP	3.3K	5%	1/10W
R190	1-216-069-00	METAL CHIP	6.8K	5%	1/10W
R191	1-216-097-00	METAL CHIP	100K	5%	1/10W
R192	1-216-081-00	METAL CHIP	22K	5%	1/10W
R193	1-216-105-00	METAL CHIP	220K	5%	1/10W
R194	1-216-069-00	METAL CHIP	6.8K	5%	1/10W

Ref. No.	Part No.	Description	Remark
R195	1-216-085-00	METAL CHIP	33K 5% 1/10W
R196	1-216-097-00	METAL CHIP	100K 5% 1/10W
R197	1-216-089-00	METAL CHIP	47K 5% 1/10W
R198	1-216-081-00	METAL CHIP	22K 5% 1/10W
R199	1-216-099-00	METAL CHIP	120K 5% 1/10W
R200	1-216-085-00	METAL CHIP	33K 5% 1/10W
R201	1-216-095-00	METAL CHIP	82K 5% 1/10W
R202	1-216-081-00	METAL CHIP	22K 5% 1/10W
R205	1-216-097-00	METAL CHIP	100K 5% 1/10W
R206	1-216-081-00	METAL CHIP	22K 5% 1/10W
R207	1-216-051-00	METAL CHIP	1.2K 5% 1/10W
R208	1-216-051-00	METAL CHIP	1.2K 5% 1/10W
R209	1-216-073-00	METAL CHIP	10K 5% 1/10W
R210	1-216-081-00	METAL CHIP	22K 5% 1/10W
R211	1-216-017-00	METAL CHIP	47 5% 1/10W
R212	1-216-017-00	METAL CHIP	47 5% 1/10W
R213	1-216-065-00	METAL CHIP	4.7K 5% 1/10W
R214	1-216-065-00	METAL CHIP	4.7K 5% 1/10W
R215	1-216-073-00	METAL CHIP	10K 5% 1/10W
R216	1-216-081-00	METAL CHIP	22K 5% 1/10W
R217	1-216-081-00	METAL CHIP	22K 5% 1/10W
R218	1-216-077-00	METAL CHIP	15K 5% 1/10W
R219	1-216-065-00	METAL CHIP	4.7K 5% 1/10W
R220	1-216-079-00	METAL CHIP	18K 5% 1/10W
R222	1-216-129-00	METAL CHIP	2.2M 5% 1/10W
< VARIABLE RESISTOR >			
RV101	1-228-993-00	RES, ADJ, METAL	4.7K
RV102	1-228-994-00	RES, ADJ, METAL	10K
RV103	1-228-994-00	RES, ADJ, METAL	10K
RV104	1-228-993-00	RES, ADJ, METAL	4.7K
RV105	1-228-994-00	RES, ADJ, METAL	10K
RV106	1-228-990-00	RES, ADJ, METAL	1K
RV107	1-228-990-00	RES, ADJ, METAL	1K
RV108	1-228-990-00	RES, ADJ, METAL	1K

*	1-645-587-11	SW-717 BOARD	

< CONNECTOR >			
CN801	1-506-467-11	PIN, CONNECTOR	2P
< SWITCH >			
S801	1-554-655-00	SWITCH, LEAF (TRAY SW)	

Ref. No.	Part No.	Description	Remark
*	1-645-588-11	SW-718 BOARD	

< CONNECTOR >			
CN901	1-506-481-11	PIN, CONNECTOR	2P
CN902	1-506-481-11	PIN, CONNECTOR	2P
< RESISTOR >			
R901	1-249-423-11	CARBON	3.3K 5% 1/4W F
R902	1-249-417-11	CARBON	1K 5% 1/4W F
< SWITCH >			
S901	1-571-300-21	SWITCH, ROTARY (CHUCK SW)	

*	1-645-592-22	TR-710 BOARD	

< CAPACITOR >			
△C301	1-136-472-11	FILM	0.1uF 20% 250V
C302	1-163-038-00	CERAMIC CHIP	0.1uF 25V
C303	1-163-077-00	CERAMIC CHIP	0.1uF 10% 25V
< CONNECTOR >			
△CN301	1-564-419-11	HEADER, SPRING (POWER)	2P
* CN302	1-564-031-00	PIN, CONNECTOR	6P
< FUSE >			
△F301	1-532-285-00	FUSE, TIME-LAG (1.25A 250V)	
△F302	1-532-284-00	FUSE, TIME-LAG (630mA 250V)	
< SWITCH >			
△S901	1-570-615-11	SELECTOR, POWER VOLTAGE	
< TRANSFORMER >			
△T301	1-450-972-11	TRANSFORMER, POWER	
△T302	1-424-656-11	FILTER, LINE	

*	A-6426-539-A	VS-702 BOARD, COMPLETE	

< SWITCH >			
△S901	1-570-615-11	SELECTOR, POWER VOLTAGE	(120V → 220V → 240V)

The components identified by mark △ or dotted line with mark △ are critical for safety. Replace only with part number specified.

Ref. No.	Part No.	Description	Remark
----------	----------	-------------	--------

MISCELLANEOUS

23	1-693-095-61	REMOTE COMMANDER (RMT-16A)	
55	A-6415-359-A	MOTOR BLOCK ASSY (X).	
△109	1-575-912-21	CORD, POWER	
* 112	1-696-664-11	WIRE, FLAT (28CORE)	
△113	1-533-189-11	HORDER, FUSE	
157	A-6415-290-A	MOTOR BLOCK ASSY, SKEW	
158	1-554-468-00	SWITCH, LEAF	
159	1-541-776-21	MOTOR, LD SPINDLE	
168	1-574-648-11	CABLE, FLEXIBLF FLAT (24 CORE)	
204	1-570-771-21	SWITCH	
206	1-571-435-11	SWITCH	
213	A-6415-434-A	MOTOR BLOCK ASSY, SLED(M902)	
△ 215	8-848-138-11	DEVICE, OPTICAL KHS-130A	

ACCESSORIES & PACKING MATERIALS

	1-551-086-31	CORD, CONNECTION	
	1-559-533-11	CORD, CONNECTION	
	1-569-008-11	ADAPTER, CONVERSION 2P	
	1-693-095-61	REMOTE COMMANDER (RMT-16A)	
	3-755-792-11	MANUAL, INSTRUCTION (ENGLISH, CHINESE)	
*	3-950-123-02	CUSHION (UPPER)	
*	3-950-124-01	CUSHION (LOWER)	
*	3-950-416-01	INDIVIDUAL CARTON	

HARDWARE LIST

#1	7-624-108-04	STOP RING 4.0, TYPE -E	
#2	7-685-648-79	SCREW +BVTP 3X12 TYPE2 IT-3	
#3	7-624-190-81	STOP RING 2, TYPE-CS	
#4	7-685-647-79	SCREW +BTP 3X10 TYPE2 N-S	
#5	7-685-646-79	SCREW +BVTP 3X8 TYPE2 IT-3	
#6	7-682-645-01	SCREW +PS 3X4	
#7	7-621-255-55	SCREW +P 2X8	
#8	7-685-649-79	SCREW +BVTP 3X14 TYPE2 IT-3	
#9	7-685-661-79	SCREW +BVTP 4X12 TYPE2 SLIT	
#10	7-628-254-20	+PSW, 2.6X8	
#11	7-682-545-04	SCREW (3X4) (G), TAPPING, (+) P	

The components identified by mark △ or dotted line with mark △ are critical for safety. Replace only with part number specified.

SECTION 7

ELECTRICAL ADJUSTMENTS

During these adjustment, see the parts arrangement diagram for adjustments on page from 148.

7-1. LIST OF SERVICING JIGS

- Oscilloscope
- Color monitor TV
- Digital voltmeter
- Audio level meter
- Frequency counter
- Remote commander (RMT-M16A)
- LD alignment disc HVL-8 (8-797-008-00)
- NTSC Ref. Disc 8 (Ref. 7 is also available)
- CD alignment disc YEDS-18 (3-702-101-01)
- MD adjustment cable (J-6082-059-B)
- Audio oscillator

7-2. CAUTIONS ON ADJUSTMENT

- Disc load/unload operation must not be performed when servicing with the unit laying down sideways. (Never press the OPEN and CLOSE buttons.)
- When laying the unit down sideways, perform adjustment with the left side down and turn the power on.
- When adjusting the servo system, be sure to set up the unit horizontally.

7-3. MD ADJUSTMENT CABLE (J-6087-059-B)

MD adjustment cable is used to adjust the servo system with connecting to the SV-63 board. Remove it except when adjusting the servo system.

7-4. POWER SUPPLY CHECK (PS-710 BOARD)

Mode	Stop
Measuring Equipment	Digital Voltmeter
UNREG + 16 V check	
Measurement Point	Pin ① of CN104 (Pin ②, GND)
Specified Value	16.2 ± 1.0 V
UNREG - 16 V check	
Measurement Point	Pin ④ of CN104 (Pin ③, GND)
Specified Value	- 16.2 ± 1.0 V
REG + 5 V check	
Measurement Point	Pin ① of CN103 (Pin ②, GND)
Specified Value	5.1 ± 0.3 V
REG - 5 V check	
Measurement Point	Pin ③ of CN103 (Pin ②, GND)
Specified Value	- 5.0 ± 0.2 V
AC 3.1 V check	
Measurement Point	Pin ①, ② of CN105
Specified Value	3.2 ± 1.0 V AC
DC - 30 V check	
Measurement Point	Pin ④ of CN105 (Pin ③, GND)
Specified Value	- 33.0 ± 2.0 V
EVER 5V Check	
Measurement Point	Pin ⑥ of CN105 (Pin ⑦, GND)
Specified Value	5.0 ± 0.2 V

- Confirm that the power supply voltages satisfy the respective specified values.

7-5. SYSTEM CONTROL SYSTEM ADJUSTMENT

7-5-1. Microprocessor Clock Adjustment (MB-701 Board)

Mode	Stop
Measurement Point	Pin ⑩ of IC107
Measuring Equipment	Frequency counter
Adjusting Element	CT001
Specified Value	14,318,180 ± 40 Hz

Adjustment method :

- 1) Adjust CT001 to 14,318,180 ± 40 Hz.

7-6. SERVO SYSTEM ADJUSTMENT

When adjusting the servo system, look out for the following items :

- Use the MD adjustment cable (J-6082-059-B).
- Adjust the CD servo system after the digital audio system adjustment is completed.
- When setting the tracking servo to the open state, set to the STOP state once and proceed to the next step.
- When the optical block is replaced, perform the adjustment in the following order.

Note : Start adjustment at maximum RF H level (RV108 fully counterclockwise direction).

1. LD Tracking Balance Adjustment
 - 1) Focus balance adjustment
 - 2) Tracking balance adjustment
2. LD Focus Gain Adjustment
3. LD Cross Talk Balance Adjustment
 - 1) TAN cam adjustment
 - 2) RAD-TILT adjustment
 - 3) Focus balance adjustment
4. LD Tracking Gain Adjustment
5. RD Adjustment
6. CD Focus Balance Adjustment
7. CD RF H Level Adjustment
8. CD RF L Level Adjustment

7-6-1. LD Servo System Adjustment

1. LD Tracking Balance Adjustment (SV-63 Board)

1) Focus balance adjustment

Note : Perform successively 1) and 2) adjustment in this order.

Mode	Still
Signal	Frame 2201 (GRAY)
Measurement Point	MD adjustment cable [TRKG ERR (X)] (Pin ③ of CN105)
Measuring Equipment	Oscilloscope
Adjusting Element	RV102
Specified Value	Maximum amplitude

Adjustment method :

- 1) Select STILL (M) mode.
- 2) Search the frame 2201 (GRAY).
- 3) Turn the thread servo off. (MD adjustment cable SLED SW OFF)
- 4) Turn the tracking servo off. (MD adjustment cable TRKG SW OFF)
- 5) Adjust RV102 so as to maximize the signal level.

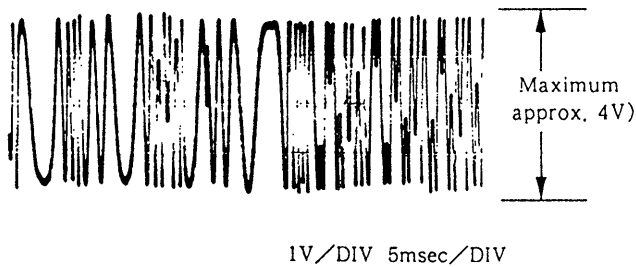

Fig. 7-1.

2) Tracking balance adjustment

Mode	Still
Signal	Frame 2201 (GRAY)
Measurement Point	MD adjustment cable [TRKG ERR (X)] (Pin ③ of CN105)
Measuring Equipment	Oscilloscope
Adjusting Element	RV101
Specified Value	$A - B = 0 \pm 0.1V$

Adjustment method :

Note : Perform successively this adjustment after "1) Focus balance adjustment" is completed.

- 6) Adjust RV101 so that the center voltage of the tracking error signal becomes $0 \pm 0.1Vdc$.
- 7) Select STOP mode.
- 8) Turn the tracking servo on.
- 9) Turn the thread servo on.

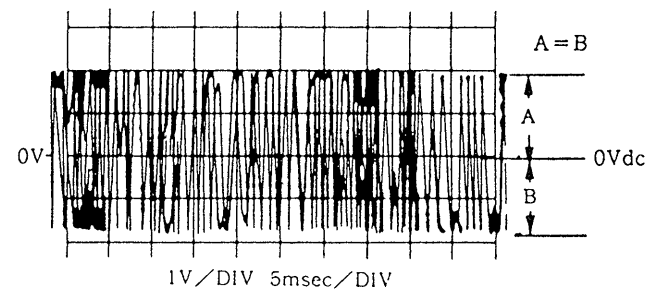
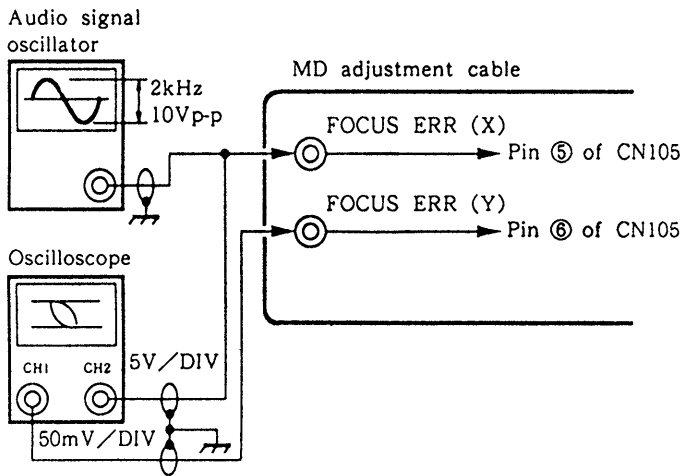

Fig. 7-2.

2. LD Focus Gain Adjustment (SV-63 Board)

Mode	Playback
Signal	Frame 2201 (GRAY)
Measurement Point	MD adjustment cable CH1 : [FOCUS ERR (Y)] (Pin ⑥ of CN105) CH2 : [FOCUS ERR (X)] (Pin ⑤ of CN105)
Measuring Equipment	Oscilloscope (X-Y mode)
Adjusting Element	RV107
Specified Value	See figure below

Connections :



Adjustment method :

- 1) Search the frame 2201.
- 2) Adjust the waveform as shown in the figure below with RV107.

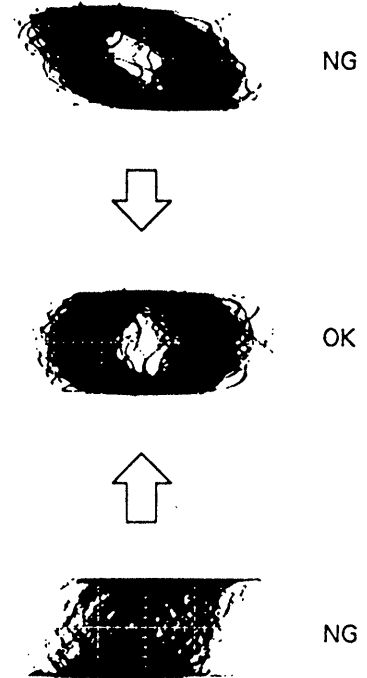

Fig. 7-3.

3. LD Cross Talk Balance Adjustment

1) TAN cam adjustment (MD)

The cam is always set to the initial position. When replacing the optical block and so on, set the cam to the mechanical center.

*Mechanical center :

Marked with the notch of the cam located at the opposite side of the optical block chassis shaft.

Adjustment method :

- 1) Turn the TAN cam on the bottom (See Fig. 7-9.) with a hexagonal wrench.

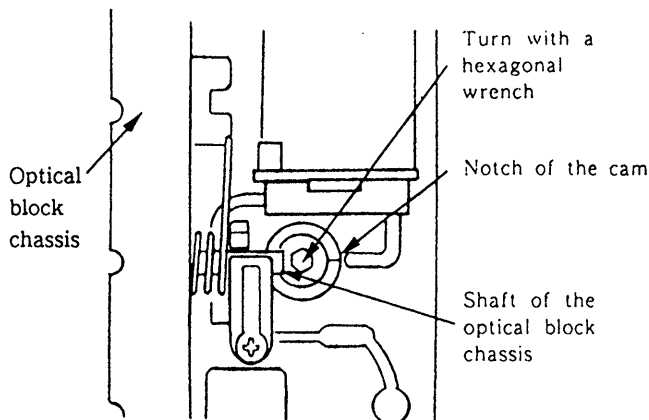

Fig. 7-4.

2) RAD TILT adjustment (SV-63 board)

Mode	Still
Signal	Frame 770 (V BAR)
Measurement Point	Monitor TV
Measuring Equipment	Monitor TV
Adjusting Element	RV105
Specified Value	Cross talk (wavering) with minimum as well as the same level.

Adjustment method :

- 1) Select STILL (M) mode.
- 2) Search the frame 770 and apply a vertical bar signal.
- 3) Adjust RV105 so that the right and left cross talks (wavering) become minimum as well as the same level.

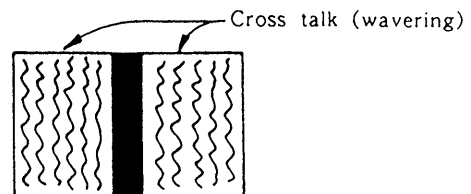

Adjust so that cross talks appeared on the both sides on the monitor display become minimum as well as the same level.

Fig. 7-5.

3) Focus balance adjustment (SV-63 board)

Mode	Still
Signal	Frame 770 (V BAR)
Measurement Point	Monitor TV
Measuring Equipment	Monitor TV
Adjusting Element	RV102
Specified Value	Cross talk (wavering) with minimum as well as the same level.

Adjustment method :

- 1) Select STILL (M) mode.
- 2) Search the frame 770 and apply a vertical bar signal.
- 3) Adjust RV102 to minimize the right and left cross talks (wavering) level.

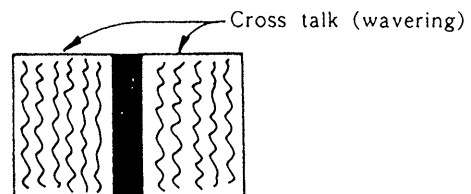
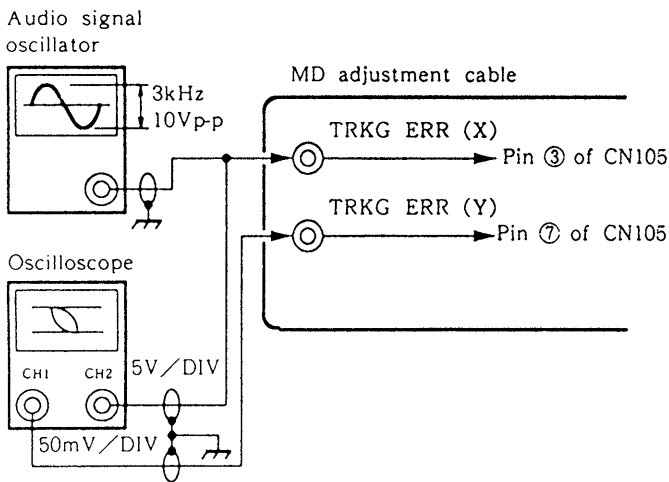

Fig. 7-6.

4. LD Tracing Gain Adjustment (SV-63 board)

Mode	Still
Signal	Frame 2201 (GRAY)
Measurement Point	MD adjustment cable CH1 : [TRKG (Y)] (Pin ⑦ of CN105) CH2 : [TRKG (X)] (Pin ③ of CN105)
Measuring Equipment	Oscilloscope (X-Y mode)
Adjusting Element	RV106 (TR GAIN)
Specified Value	See figure below

Connections :



Adjustment method :

- 1) Search the frame 2201.
- 2) Adjust the waveform as shown in the figure below with RV106.

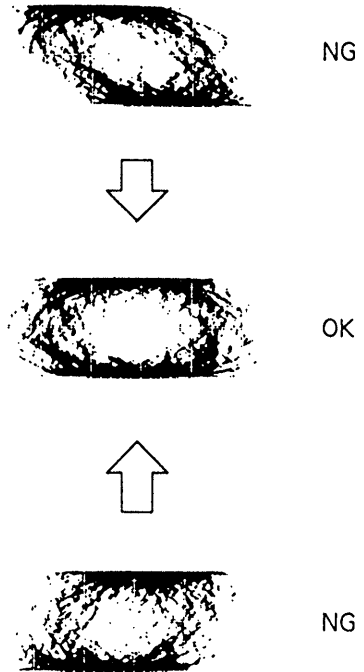

Fig. 7-7.

7-6-2. CD Servo System Adjustment

1. RD Adjustment

Mode	Pause
Signal	Track No. 1, YEDS-18
Measurement Point	MD adjustment cable CH1 : [E terminal] CH2 : [F terminal]
Measuring Equipment	Oscilloscope
Adjusting Element	RD Cam (MD)
Specified Value	A : B ≤ 10 : 1

Note : 1) Turn off the monitor TV switch to prevent a noise.

Note : 2) Long continuation of the TRKG servo off state causes the spindle motor to stop.

Adjustment method :

- 1) Play back the track No. 1 and select PAUSE mode.
- 2) Turn the thread servo off. (MD adjustment cable SLED SW OFF)
- 3) Turn the tracking servo off. (MD adjustment cable TRKG SW OFF)
- 4) Turn RD cam on the MD and adjust so that it becomes as a straight line as possible.

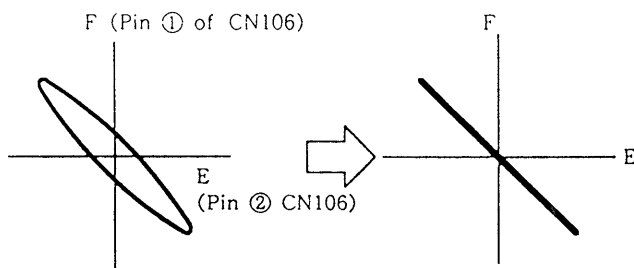

Fig. 7-8.

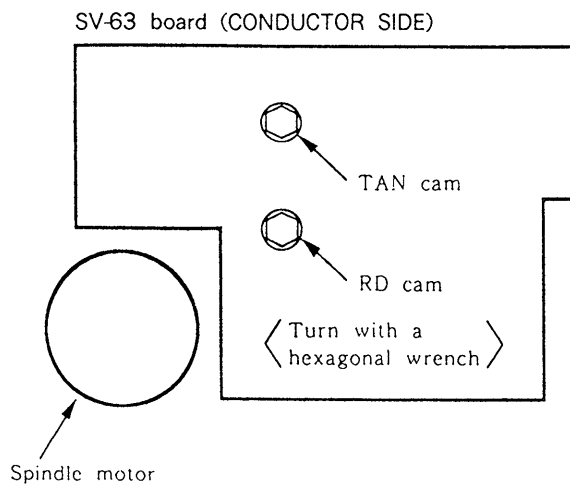

Fig. 7-9.

2. CD Focus Balance Adjustment (SV-63 Board)

Mode	Playback
Signal	Track No. 1, YEDS-18
Measurement Point	MD adjustment cable [RF (CD) OUT] (Pin ⑥ of CN106)
Measuring Equipment	Oscilloscope
Adjusting Element	RV103
Specified Value	Maximum amplitude

Adjustment method :

- 1) Play back the track No. 1.
- 2) Adjust RV103 for maximum level.

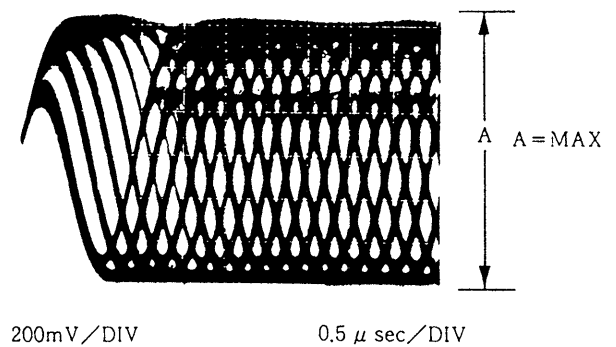

Fig. 7-10.

3. CD RF H Level Adjustment (SV-63 Board)

Mode	Playback
Signal	Track No. 1, YEDS-18
Measurement Point	MD adjustment cable [RF (CD) OUT] (Pin ⑥ of CN106)
Measuring Equipment	Oscilloscope
Adjusting Element	RV108
Specified Value	$1.2 \pm 0.1 \text{V}_{p-p}$

Adjustment method :

- 1) Play back the track No. 1.
- 2) Adjust RV108 for $1.2 \pm 0.1 \text{V}_{p-p}$.

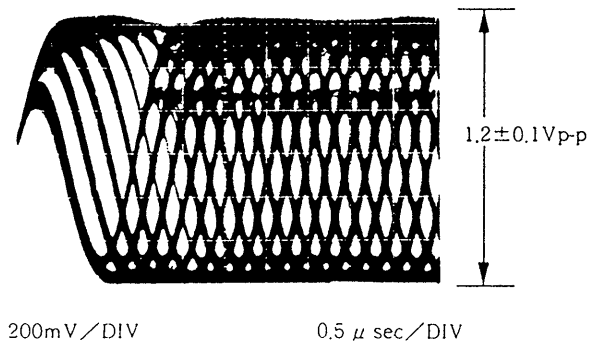

Fig. 7-11.

4. CD RF L Level Adjustment (SV-63 Board)

Mode	Playback
Signal	Track No. 1, YEDS-18
Measurement Point	MD adjustment cable [RF (CD) OUT] (Pin ⑥ of CN106)
Measuring Equipment	Oscilloscope
Adjusting Element	RV104
Specified Value	Clear-cut waveform

Adjustment method :

- 1) Play back the track No. 1.
- 2) Adjust RV104 so that the waveform of lozenge-shaped portions becomes clear-cut and the waveform slant disappears from the rising edge portion.

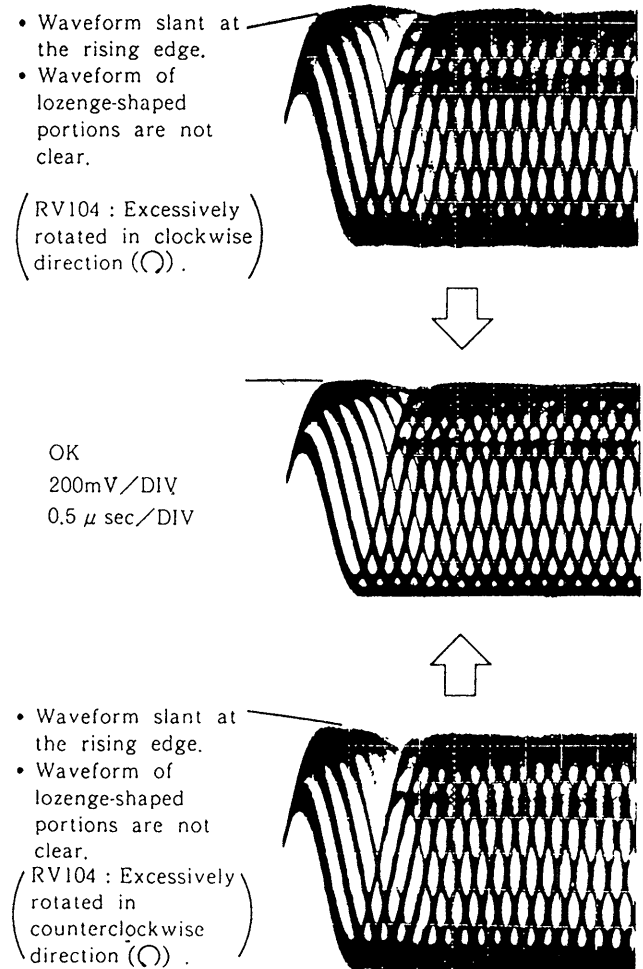

Fig. 7-12.

7-7. VIDEO SYSTEM ADJUSTMENT

7-7-1. Video Output Level Adjustment (MB-701 Board)

Mode	Still
Signal	Frame 4100 (Color bar)
Measurement Point	J201 (VIDEO OUT terminal) (Terminated to 75 Ω)
Measuring Equipment	Oscilloscope
Adjusting Element	RV002
Specified Value	1.00 ± 0.03 Vp-p

Adjustment method :

- 1) Select STILL (▶◀) mode.
- 2) Search the frame 4100 and apply a color bar signal.
- 3) Adjust RV002 for 1.00 ± 0.03 Vp-p.



Fig. 7-13.

7-8. PARTS ARRANGEMENT DIAGRAM FOR ADJUSTMENTS

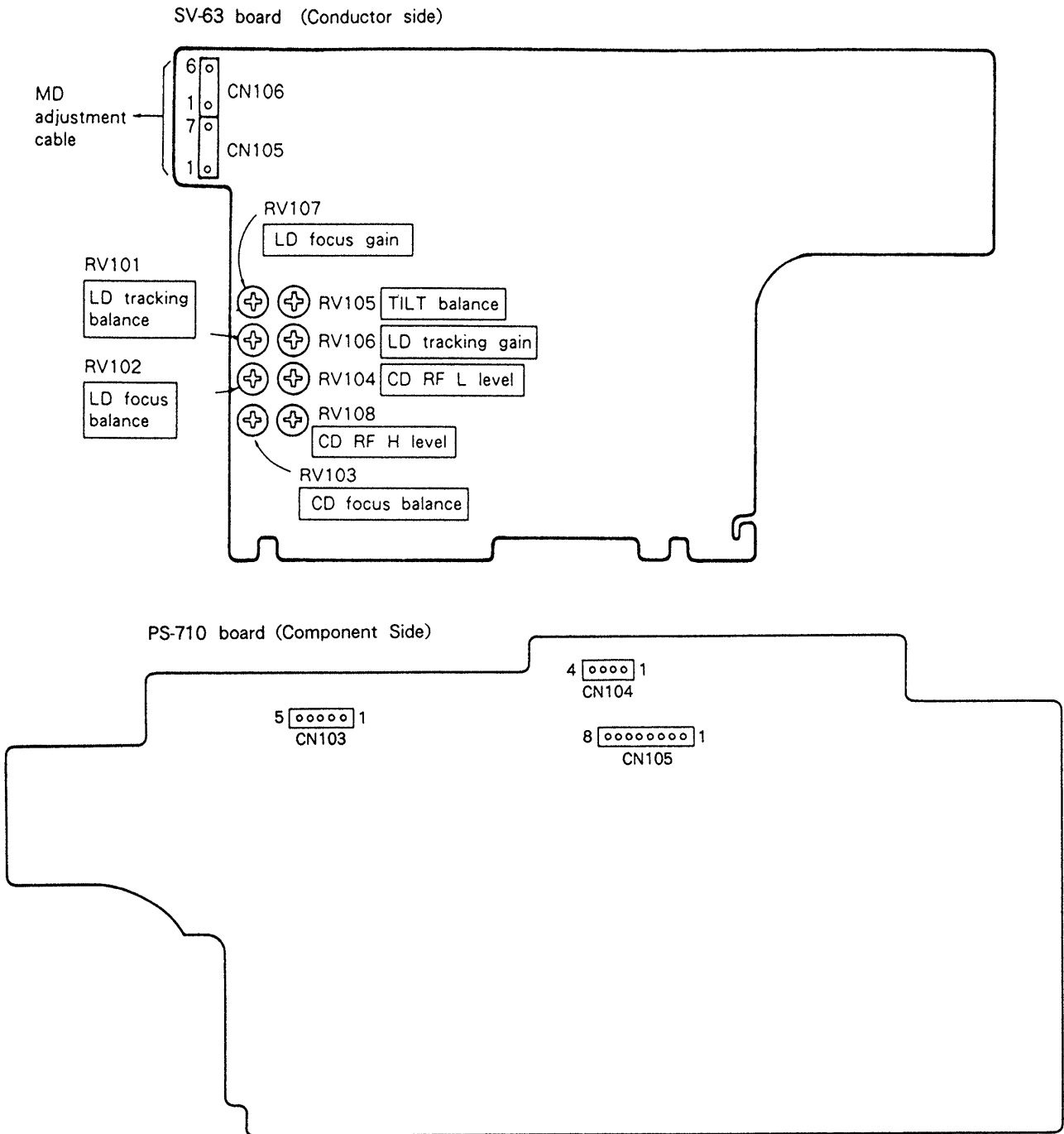

MB-701 board (Component Side)

